

US00D764426S

(12) **United States Design Patent**  
**Kwak et al.**

(10) **Patent No.:** **US D764,426 S**

(45) **Date of Patent:** **\*\* Aug. 23, 2016**

(54) **ELECTRONIC DEVICE**

(71) Applicant: **Samsung Electronics Co., Ltd.**,  
Suwon-si (KR)

(72) Inventors: **Ji-Yeon Kwak**, Seoul (KR); **Kio Lee**,  
Seoul (KR); **Hyun-Jin Kim**, Seoul (KR)

(73) Assignee: **SAMSUNG ELECTRONICS CO.,  
LTD.** (KR)

(\*\*) Term: **14 Years**

(21) Appl. No.: **29/487,406**

(22) Filed: **Apr. 8, 2014**

(30) **Foreign Application Priority Data**

Oct. 10, 2013 (KR) ..... 30-2013-0051310

(51) **LOC (10) Cl.** ..... **14-01**

(52) **U.S. Cl.**  
USPC ..... **D14/138 G**; D14/138; D14/138 C;  
D14/138 R

(58) **Field of Classification Search**  
USPC ..... D14/496, 203.3, 138 G, 480.7, 138 AD,  
D14/341, 240, 248, 138 AA; 455/575.4,  
455/566; 353/581, 122; 361/679.01;  
345/173

CPC ... H04M 1/04; H04M 1/0235; H04M 1/0237;  
A45D 42/18; G06F 1/615; G06F 1/1616  
See application file for complete search history.

(56) **References Cited**

**U.S. PATENT DOCUMENTS**

D505,428 S \* 5/2005 Yagihashi ..... D14/496  
D514,590 S \* 2/2006 Naruki ..... D14/203.3  
D541,785 S \* 5/2007 Hwang ..... D14/138 G  
D542,769 S \* 5/2007 Hwang ..... D14/138 G  
D558,763 S \* 1/2008 Morganstern ..... D14/480.7  
7,556,384 B2 \* 7/2009 Chan ..... A45D 42/18  
353/122  
D612,830 S \* 3/2010 Kim ..... D14/138 G

D622,253 S \* 8/2010 Park ..... D14/138 AD  
D631,458 S \* 1/2011 Liao ..... D14/138 G  
D636,750 S \* 4/2011 Cigliano ..... D14/138 AD  
D636,752 S \* 4/2011 Liao ..... D14/138 G  
D640,220 S \* 6/2011 Shyu ..... D14/138 AD

(Continued)

**FOREIGN PATENT DOCUMENTS**

GB 4012701 \* 10/2009  
KR 300510154.0000 \* 10/2008  
RU 00084669 \* 3/2013

**OTHER PUBLICATIONS**

Best Smartphone Design: Mobile Choice Awards 2012, Announced  
Oct. 4, 2012, [ Site Visited Dec. 20, 2015 ] [http://www.  
mobilechoicework.com/News/22792/Best-design-mobile-phone-  
Choice-Awards-2012.aspx](http://www.mobilechoicework.com/News/22792/Best-design-mobile-phone-Choice-Awards-2012.aspx).\*

(Continued)

*Primary Examiner* — John Windmuller  
*Assistant Examiner* — Luqman McNeil  
(74) *Attorney, Agent, or Firm* — Cantor Colburn LLP

(57) **CLAIM**

We claim, the ornamental design for an electronic device, as  
shown and described.

**DESCRIPTION**

FIG. 1 is a perspective view of an electronic device, showing  
our new design;  
FIG. 2 is a front elevation view thereof;  
FIG. 3 is a rear elevation view thereof;  
FIG. 4 is a side elevation view thereof;  
FIG. 5 is another side elevation view thereof;  
FIG. 6 is a top plan view thereof; and,  
FIG. 7 is a bottom plan view thereof.  
The broken lines illustrating portions of the electronic device  
are for environmental purposes only and form no part of the  
claimed design.

**1 Claim, 7 Drawing Sheets**

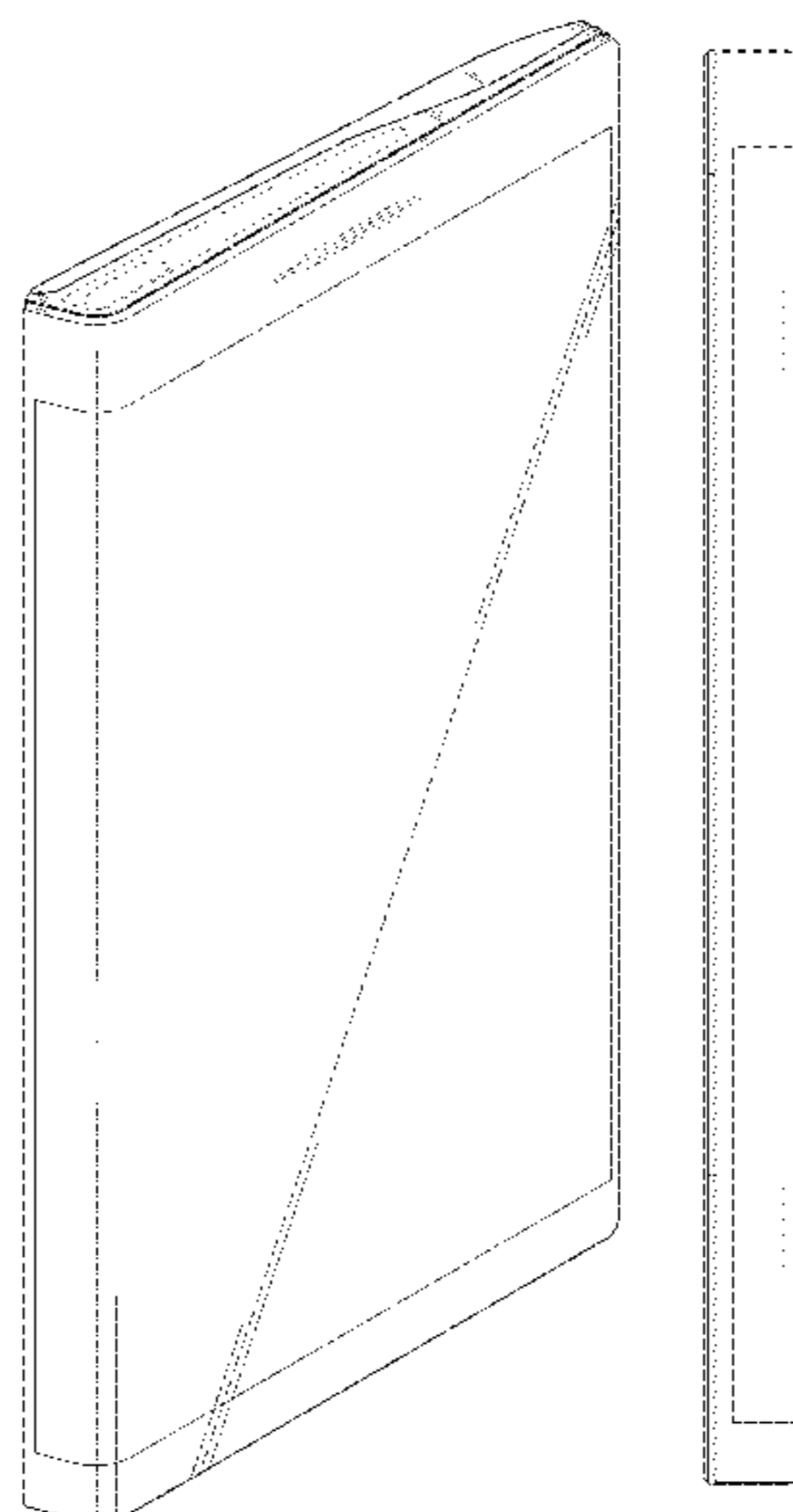

(56)

**References Cited**

U.S. PATENT DOCUMENTS

D646,250 S \* 10/2011 Han ..... D14/138 G  
 D654,073 S \* 2/2012 Li ..... D14/341  
 D654,464 S \* 2/2012 Han ..... D14/138 G  
 D658,620 S \* 5/2012 Lylyk ..... D14/138 G  
 D658,647 S \* 5/2012 Tsai ..... D14/356  
 D664,518 S \* 7/2012 Ryu ..... D14/138 G  
 D665,763 S \* 8/2012 Tsai ..... D14/138 G  
 D675,196 S \* 1/2013 Maddern ..... D14/240  
 D678,270 S \* 3/2013 Song ..... D14/341  
 D685,784 S \* 7/2013 Ma ..... D14/341  
 D692,845 S \* 11/2013 Cho ..... D14/138 G  
 D715,279 S \* 10/2014 Lee ..... D14/248  
 D715,280 S \* 10/2014 Lee ..... D14/248  
 2005/0227737 A1 \* 10/2005 Moon ..... H04M 1/04  
 455/566  
 2007/0232368 A1 \* 10/2007 Feightner ..... H04M 1/0235  
 455/575.1

2008/0274776 A1 \* 11/2008 Cho ..... H04M 1/0237  
 455/575.4  
 2010/0164973 A1 \* 7/2010 Huitema ..... G06F 1/1615  
 345/581  
 2012/0044620 A1 \* 2/2012 Song ..... G06F 1/1616  
 361/679.01  
 2013/0300697 A1 \* 11/2013 Kim ..... G06F 1/1626  
 345/173

OTHER PUBLICATIONS

HTC's Windows Phone 8X and Phone 8S: Hands -on, Announced  
 Sep. 19, 2012, [ Site Visited Dec. 30, 2015 ] [http://www.pcworld.com/  
 article/2010106/htcs-windows-phone-8x-and-phone-8s-hands-on.  
 html](http://www.pcworld.com/article/2010106/htcs-windows-phone-8x-and-phone-8s-hands-on.html). \*  
 New iPhone 6 Concept Features Flexible Wraparound Display,  
 Announced Apr. 19, 2013, [ Site Visited Dec. 30, 2015 ] [http://www.  
 iphonemods.com/2013/04/iphone-6-concept-flexible-wraparound-  
 display.html](http://www.iphonemods.com/2013/04/iphone-6-concept-flexible-wraparound-display.html). \*

\* cited by examiner

FIG. 1

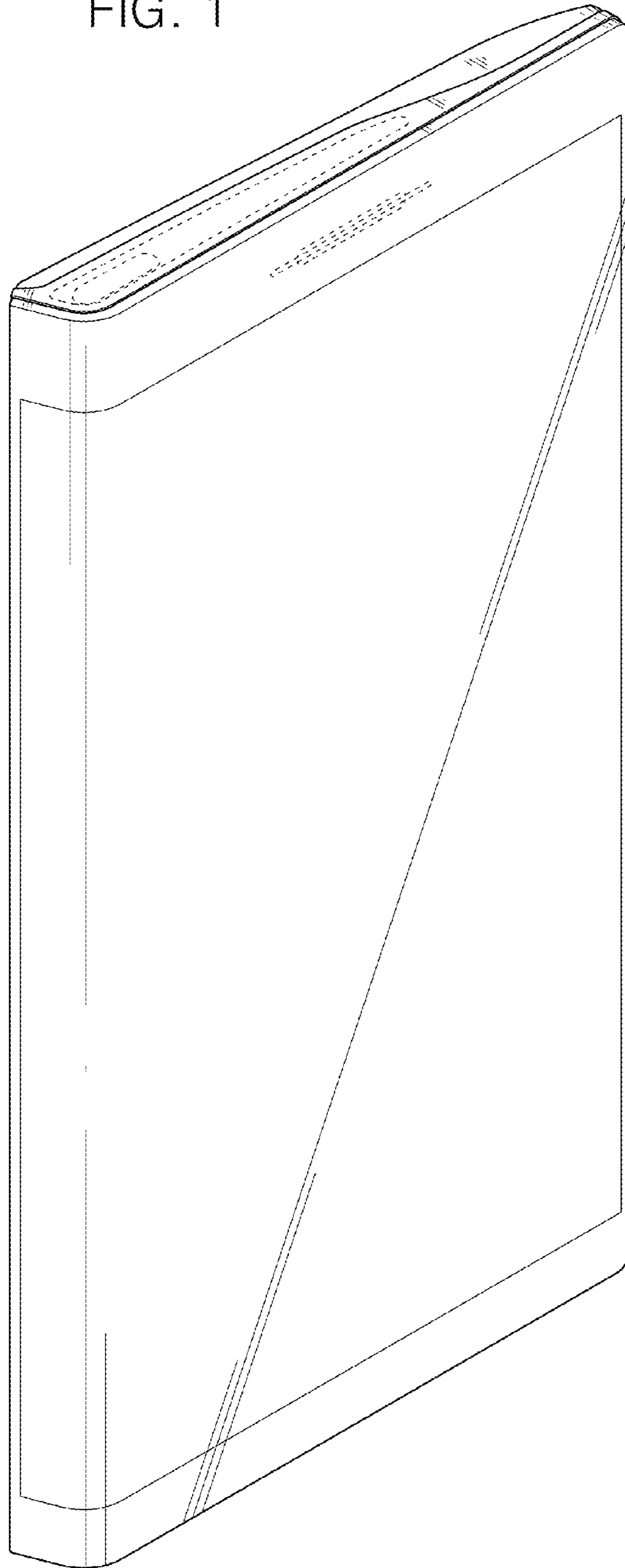

FIG. 2

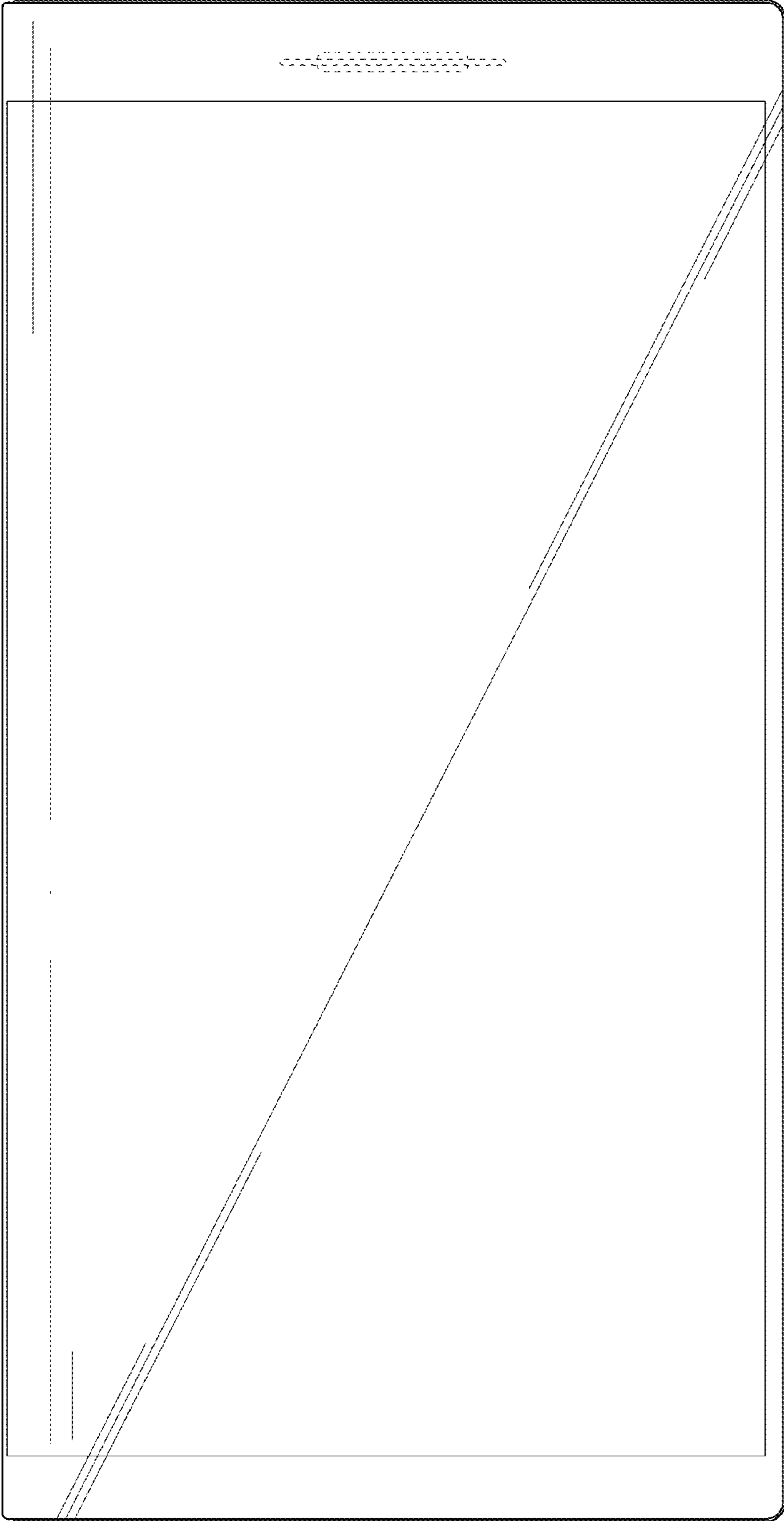

FIG. 3

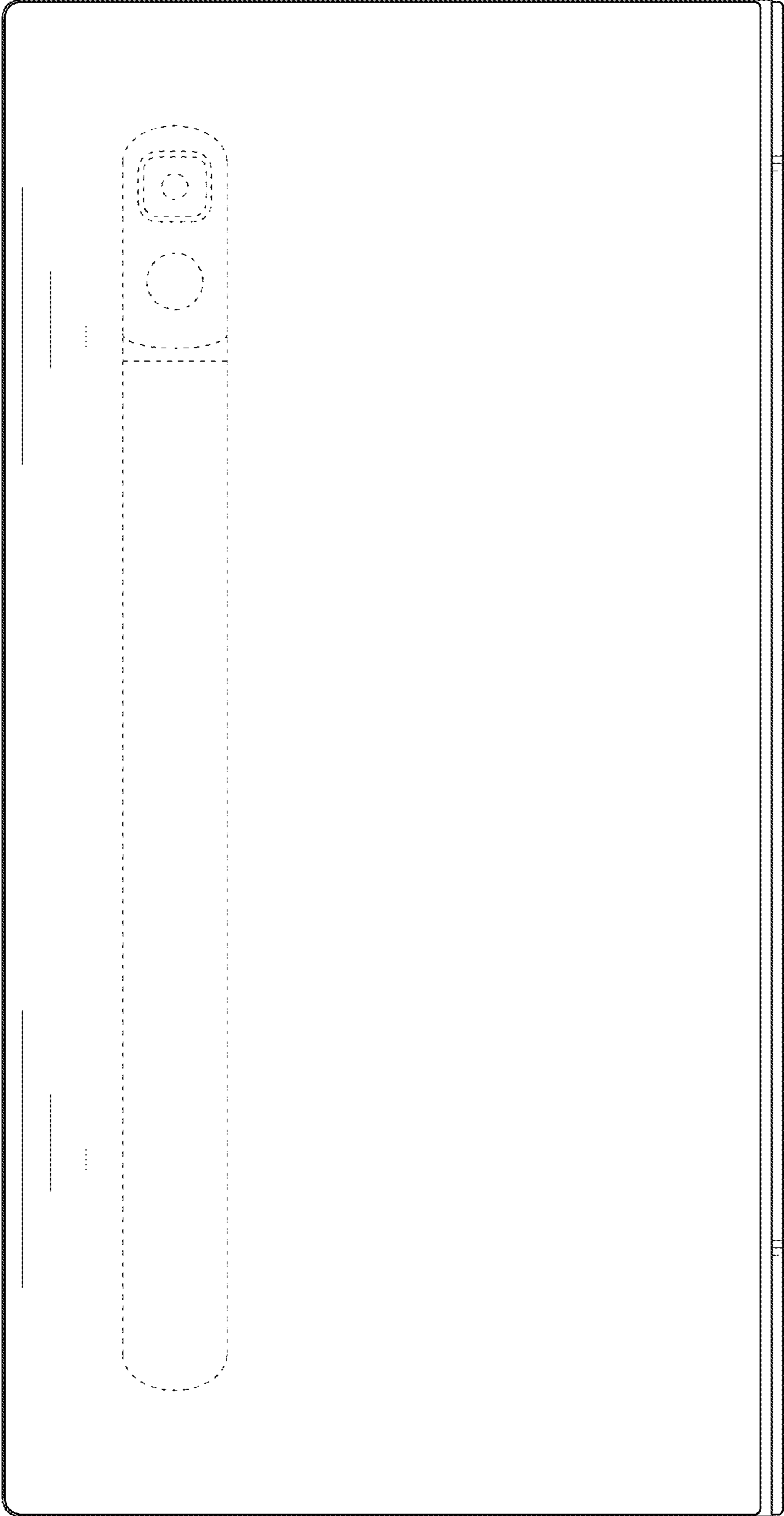

FIG. 4

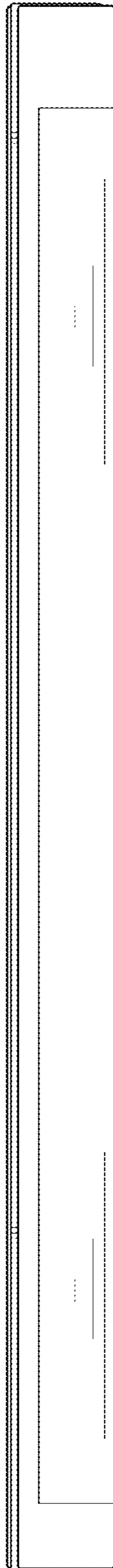

FIG. 5

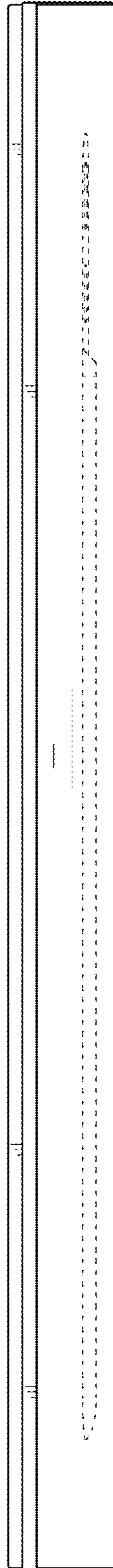

FIG. 6

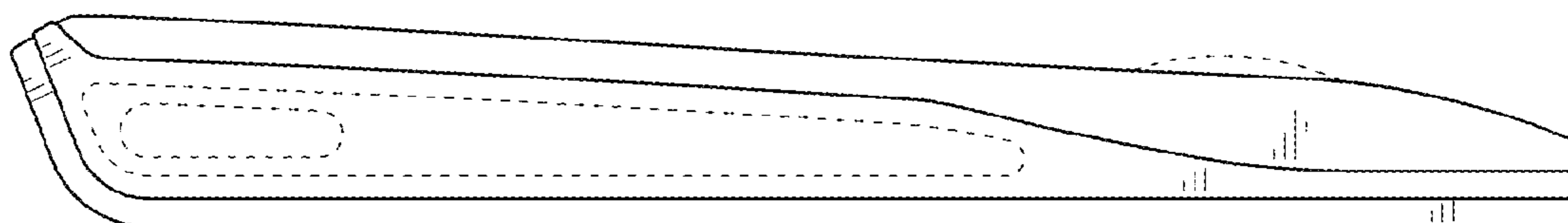



FIG. 7

