

US00D764326S

(12) **United States Design Patent**
Mathews, Jr.

(10) **Patent No.:** **US D764,326 S**
(45) **Date of Patent:** **** Aug. 23, 2016**

- (54) **TAPE MEASURE HOLSTER**
- (71) Applicant: **Python Safety, LLC**, Woodstock, GA (US)
- (72) Inventor: **William Joseph Mathews, Jr.**, Woodstock, GA (US)
- (73) Assignee: **Python Safety, LLC**, Woodstock, GA (US)
- (**) Term: **14 Years**
- (21) Appl. No.: **29/526,667**
- (22) Filed: **May 12, 2015**
- (51) **LOC (10) Cl.** **10-04**
- (52) **U.S. Cl.**
USPC **D10/74**
- (58) **Field of Classification Search**
USPC D10/72, 74
CPC G01B 3/10; G01B 3/1002; G01B 3/1041;
G01B 2003/1043; G01B 2003/1046; G01B
2003/1048; G01B 2003/1051; G01B
2003/1053; G01B 2003/1097; G01B 3/1082;
G01B 3/1056; G01B 3/563; G01B 3/566;
G01B 3/1071; G07B 3/10
See application file for complete search history.

- (56) **References Cited**
U.S. PATENT DOCUMENTS
5,024,361 A * 6/1991 Flowers A45C 13/02
224/223
5,826,762 A * 10/1998 Dellinger A45F 5/02
224/232

Primary Examiner — Antoine D Davis
(74) *Attorney, Agent, or Firm* — Dicke, Billig & Czaja, PLLC

(57) **CLAIM**
The ornamental design for a tape measure holster, as shown and described.

DESCRIPTION

FIG. 1 is a front perspective view of a tape measure holster showing an embodiment of the new design;
FIG. 2 is a front view of the embodiment shown in FIG. 1;
FIG. 3 is a rear view of the embodiment shown in FIG. 1;
FIG. 4 is a first side view of the embodiment shown in FIG. 1;
FIG. 5 is a second side view of the embodiment shown in FIG. 1;

FIG. 6 is a top view of the embodiment shown in FIG. 1;
FIG. 7 is a bottom view of the embodiment shown in FIG. 1;
FIG. 8 is a rear perspective view of a tape measure holster showing another embodiment of the new design;
FIG. 9 is a front view of the embodiment shown in FIG. 8;
FIG. 10 is a rear view of the embodiment shown in FIG. 8;
FIG. 11 is a first side view of the embodiment shown in FIG. 8;
FIG. 12 is a second side view of the embodiment shown in FIG. 8;
FIG. 13 is a top view of the embodiment shown in FIG. 8;
FIG. 14 is a bottom view of the embodiment shown in FIG. 8;
FIG. 15 is a rear perspective view of a tape measure holster showing an alternate embodiment of the new design shown in FIGS. 8-14 with the connector for the ring members shown in an alternate location;
FIG. 16 is a rear perspective view of a tape measure holster showing an alternate embodiment of the new design shown in FIGS. 8-14 with the connector for the ring members shown in an alternate location;
FIG. 17 is a rear perspective view of a tape measure holster showing an alternate embodiment of the new design shown in FIGS. 8-14 with the connector for the ring members shown in an alternate location;
FIG. 18 is a front perspective view of a tape measure holster showing another embodiment of the new design;
FIG. 19 is a front view of the embodiment shown in FIG. 18;
FIG. 20 is a rear view of the embodiment shown in FIG. 18;
FIG. 21 is a first side view of the embodiment shown in FIG. 18;
FIG. 22 is a second side view of the embodiment shown in FIG. 18;
FIG. 23 is a top view of the embodiment shown in FIG. 18; and,
FIG. 24 is a bottom view of the embodiment shown in FIG. 18.
Any broken line illustrations of environmental structure in the drawings are not part of the design sought to be patented. The broken lines showing ring members in FIGS. 1-18 illustrate environmental structure only and do not form part of the claimed design. The broken lines showing apertures in FIGS. 1, 2, 9, 18, and 19 illustrate environmental structure only and do not form part of the claimed design. The broken lines showing connectors for the ring members in FIGS. 12-18 illustrate environmental structure only and do not form part of the claimed design. The broken lines showing binding in FIGS. 12-18 illustrate environmental structure only and do not form part of the claimed design. The broken lines showing rivets in FIGS. 12-18 illustrate environmental structure only and do not form part of the claimed design.

1 Claim, 18 Drawing Sheets

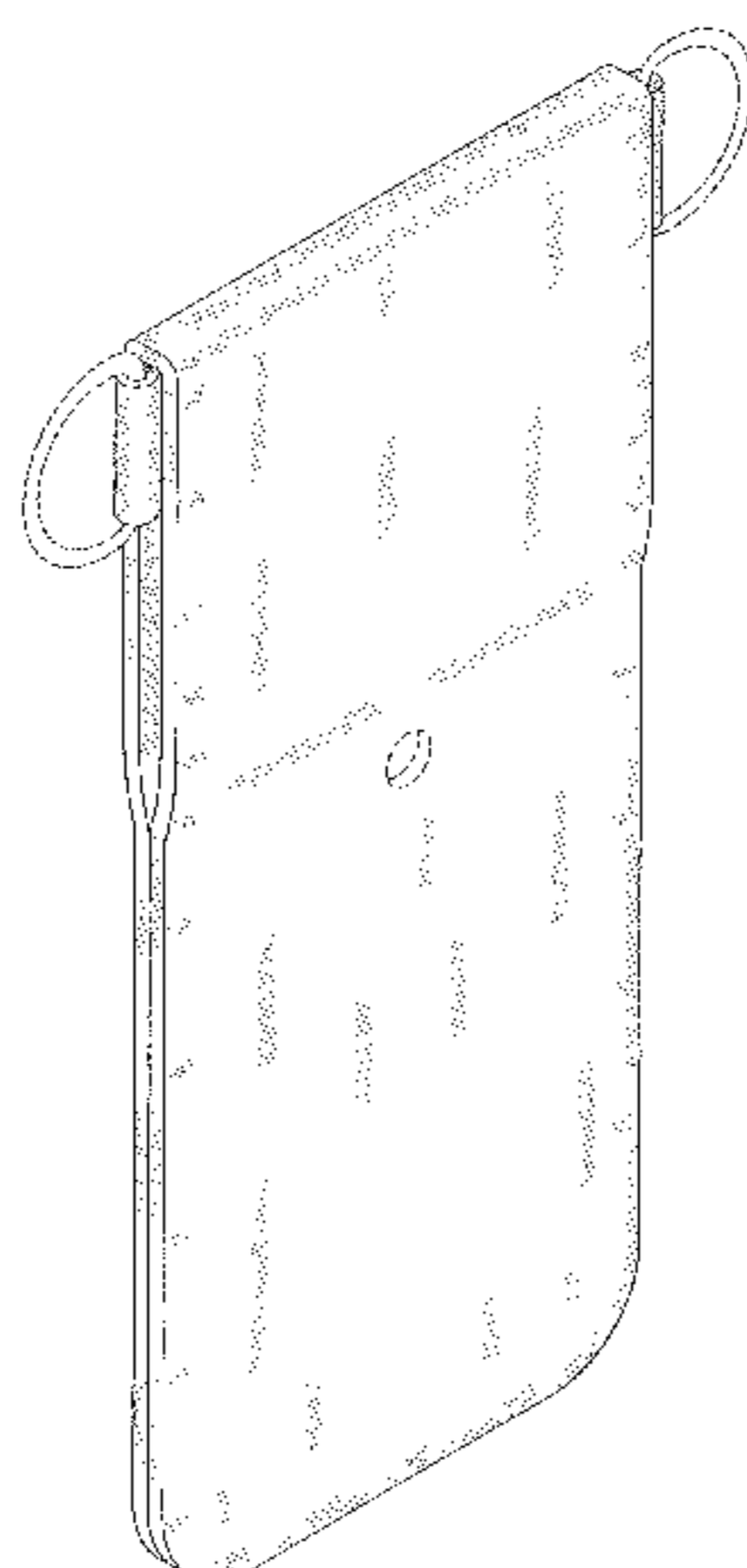

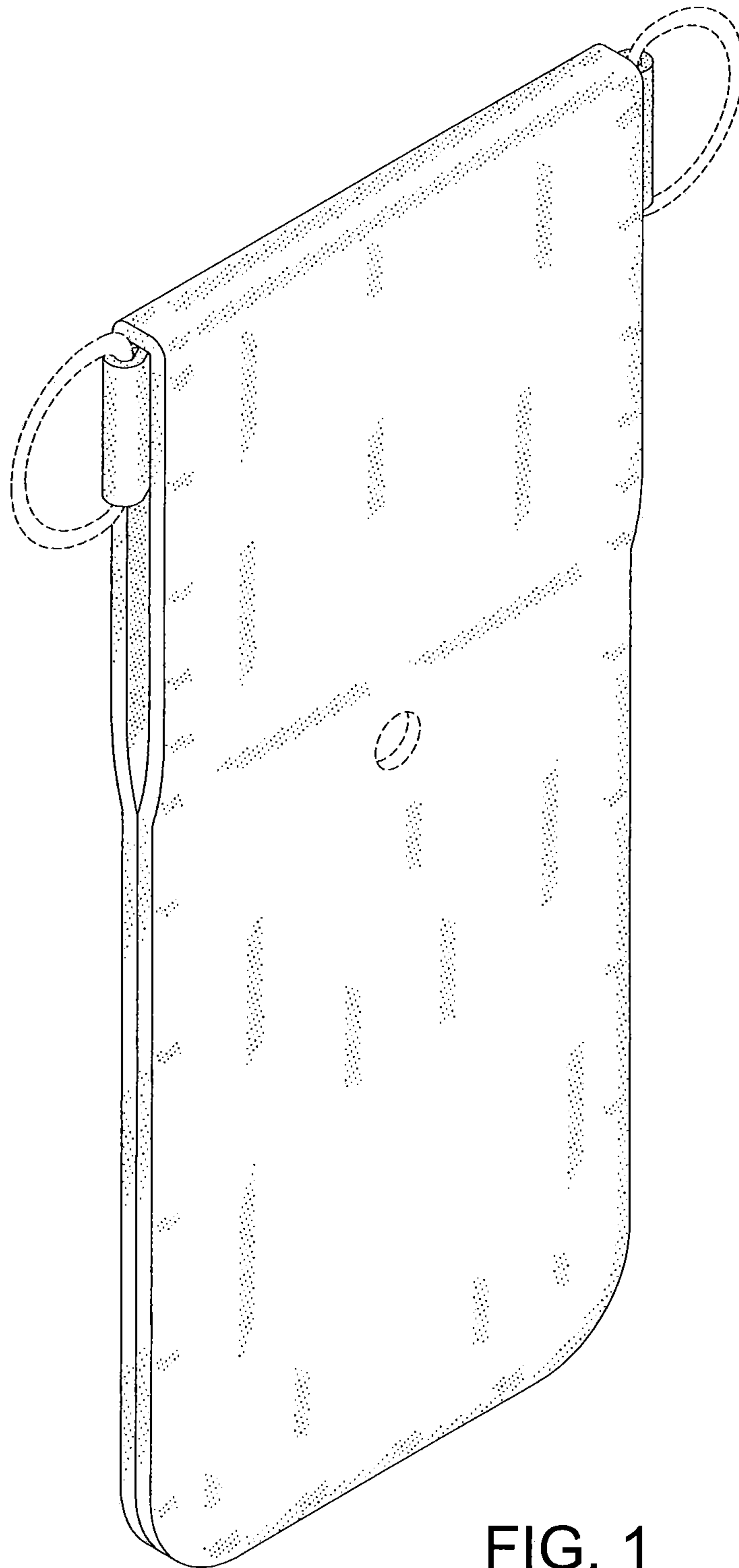

FIG. 1

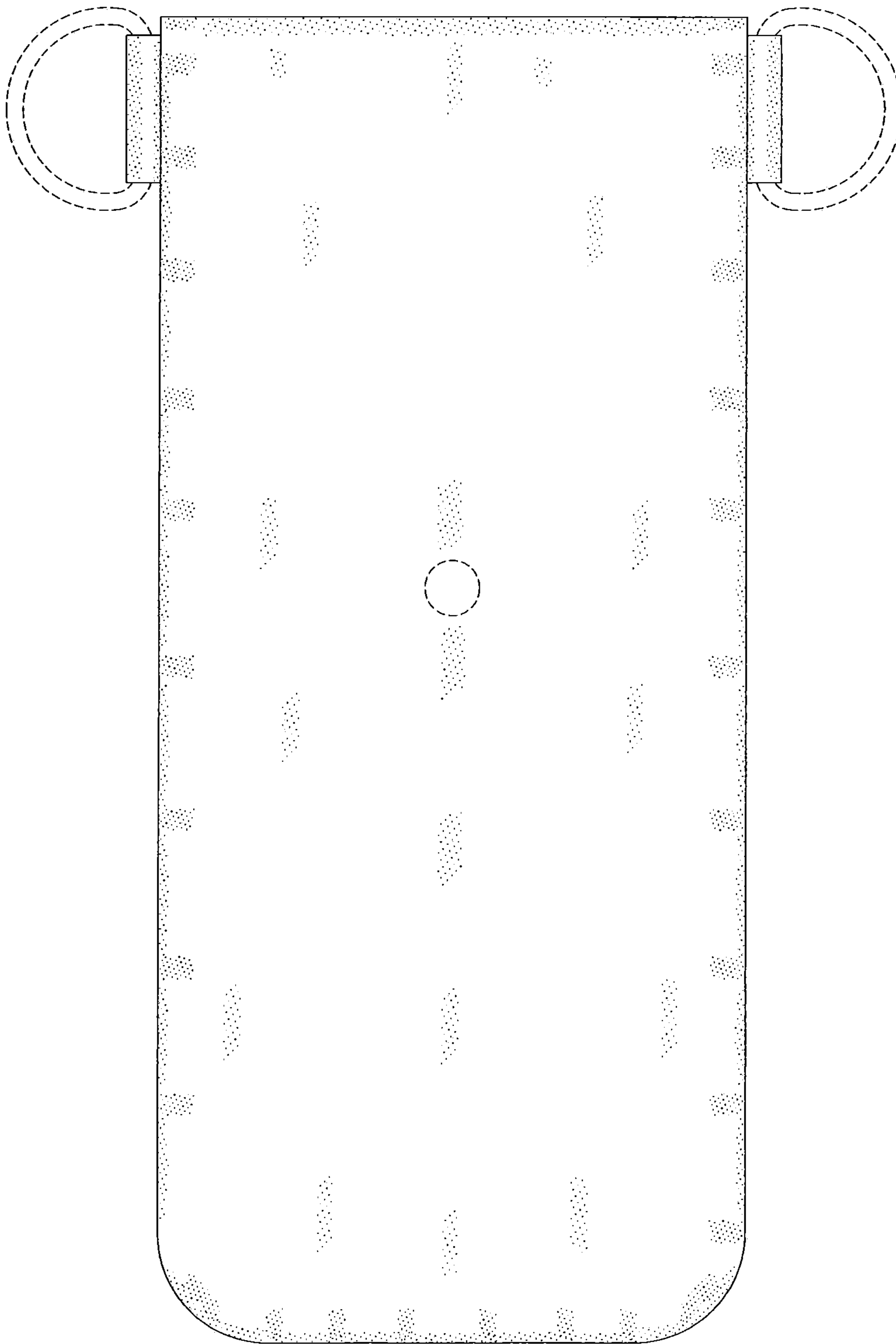

FIG. 2

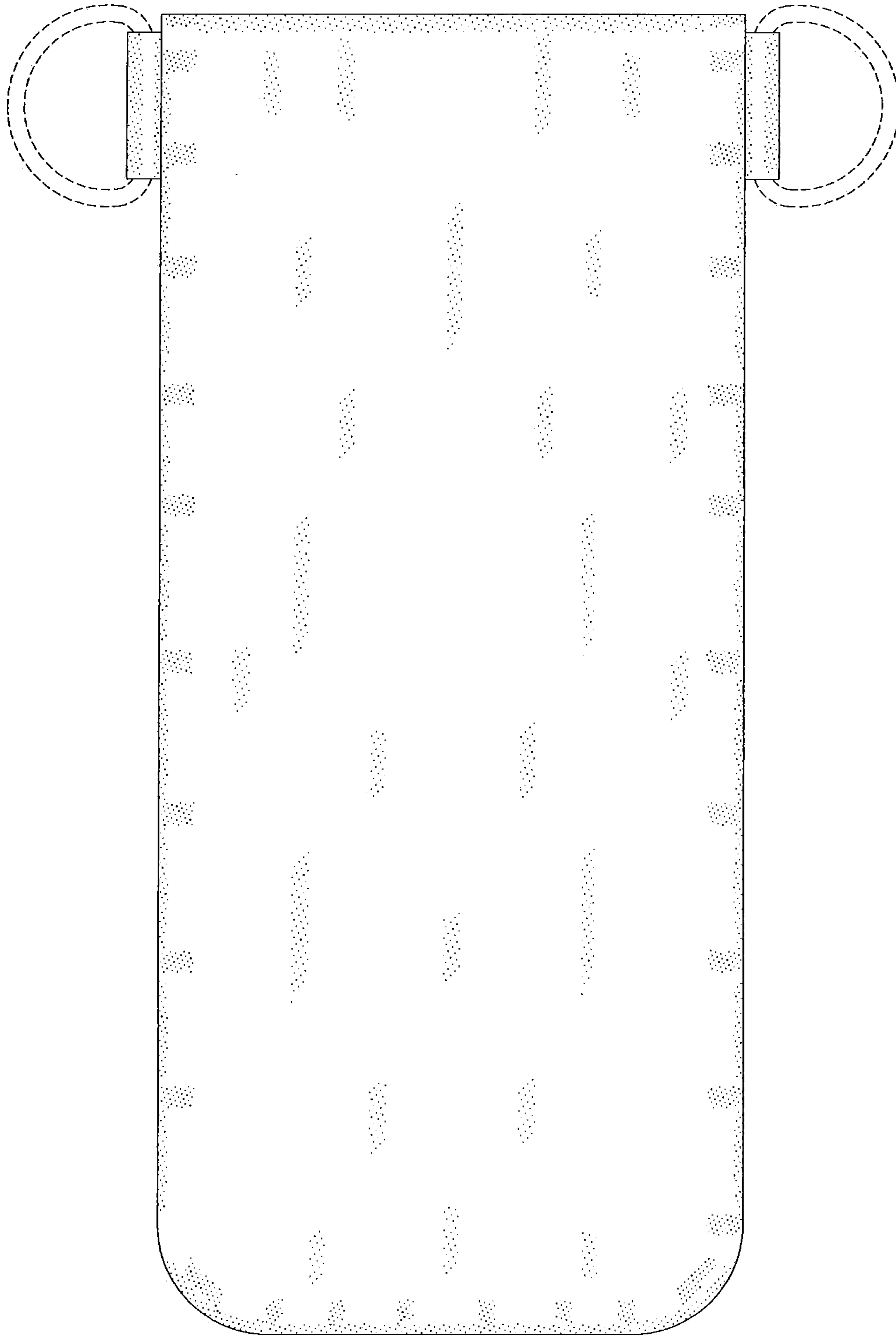

FIG. 3

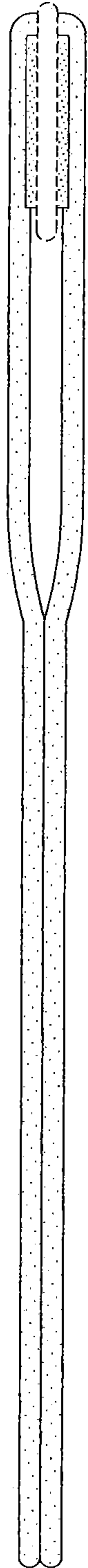

FIG. 4

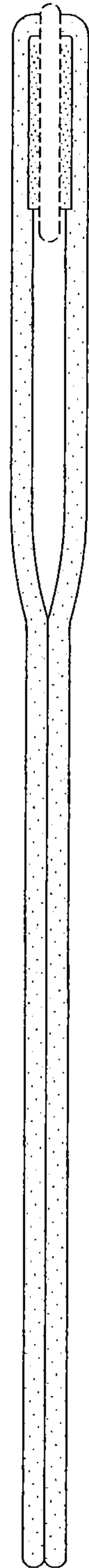

FIG. 5

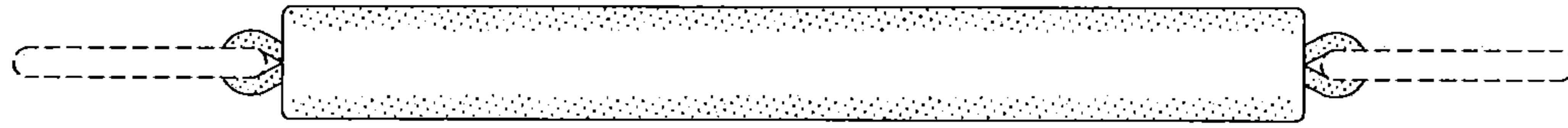

FIG. 6

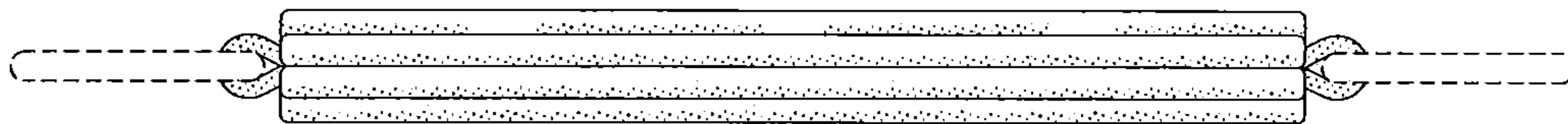

FIG. 7

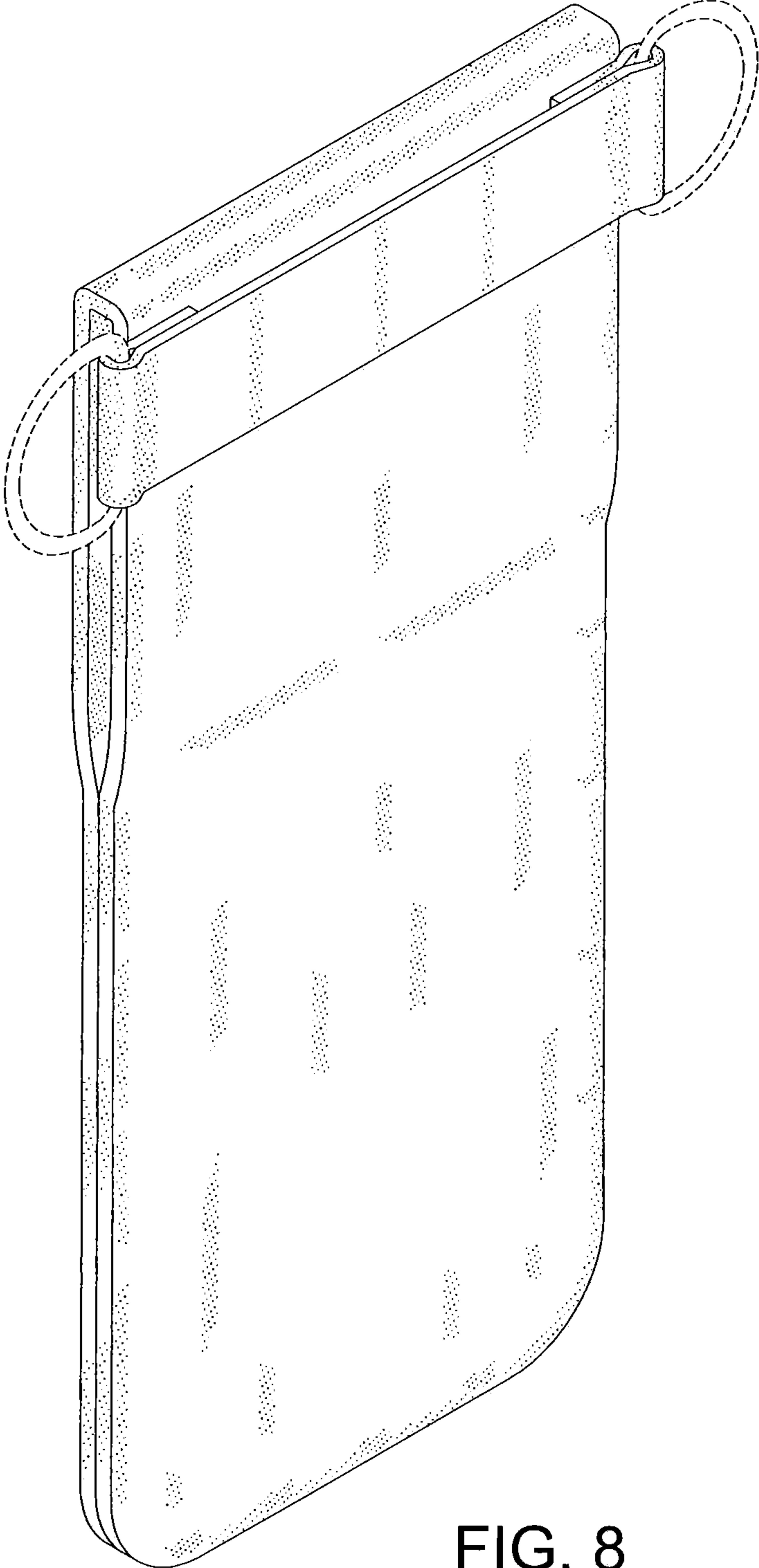

FIG. 8

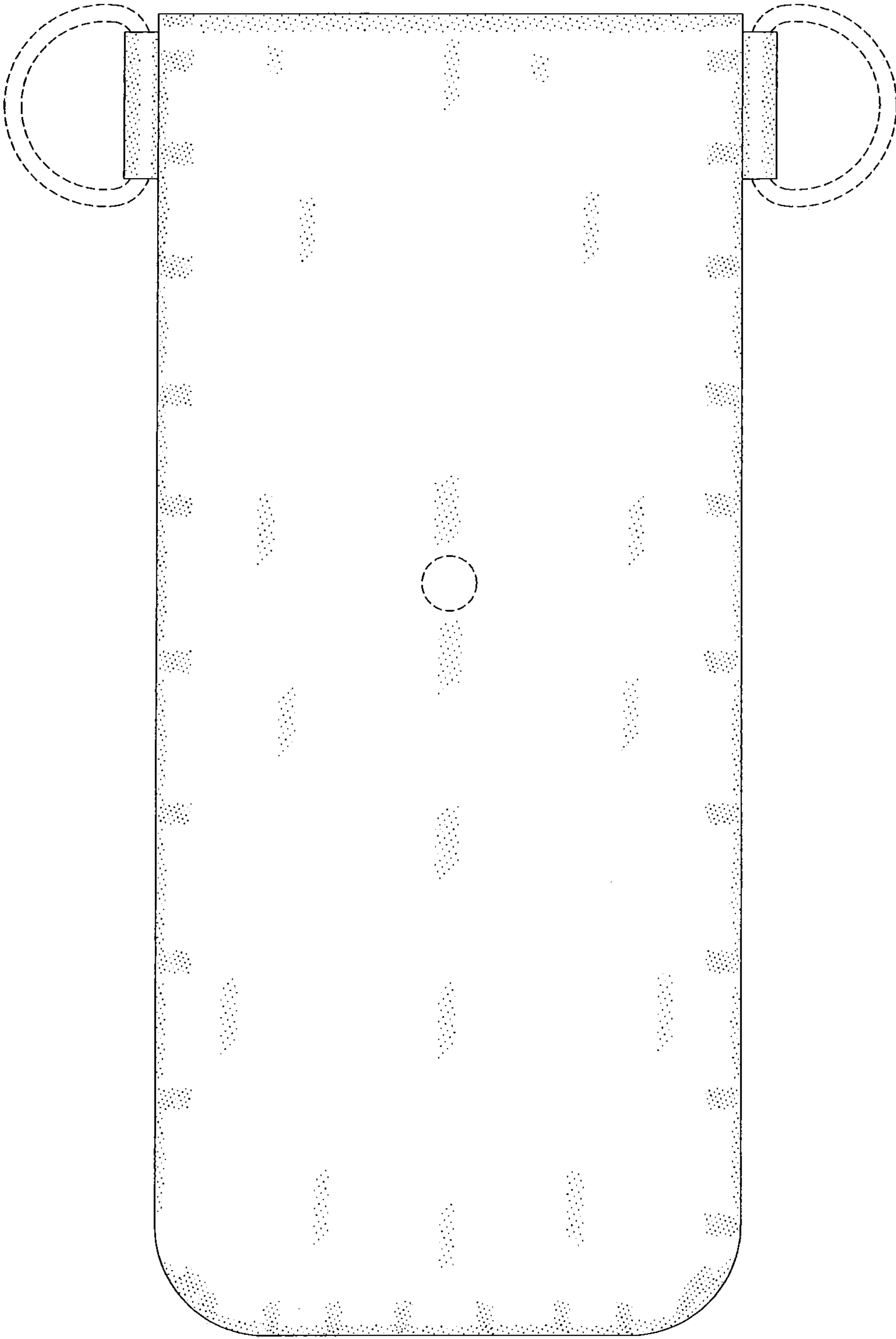

FIG. 9

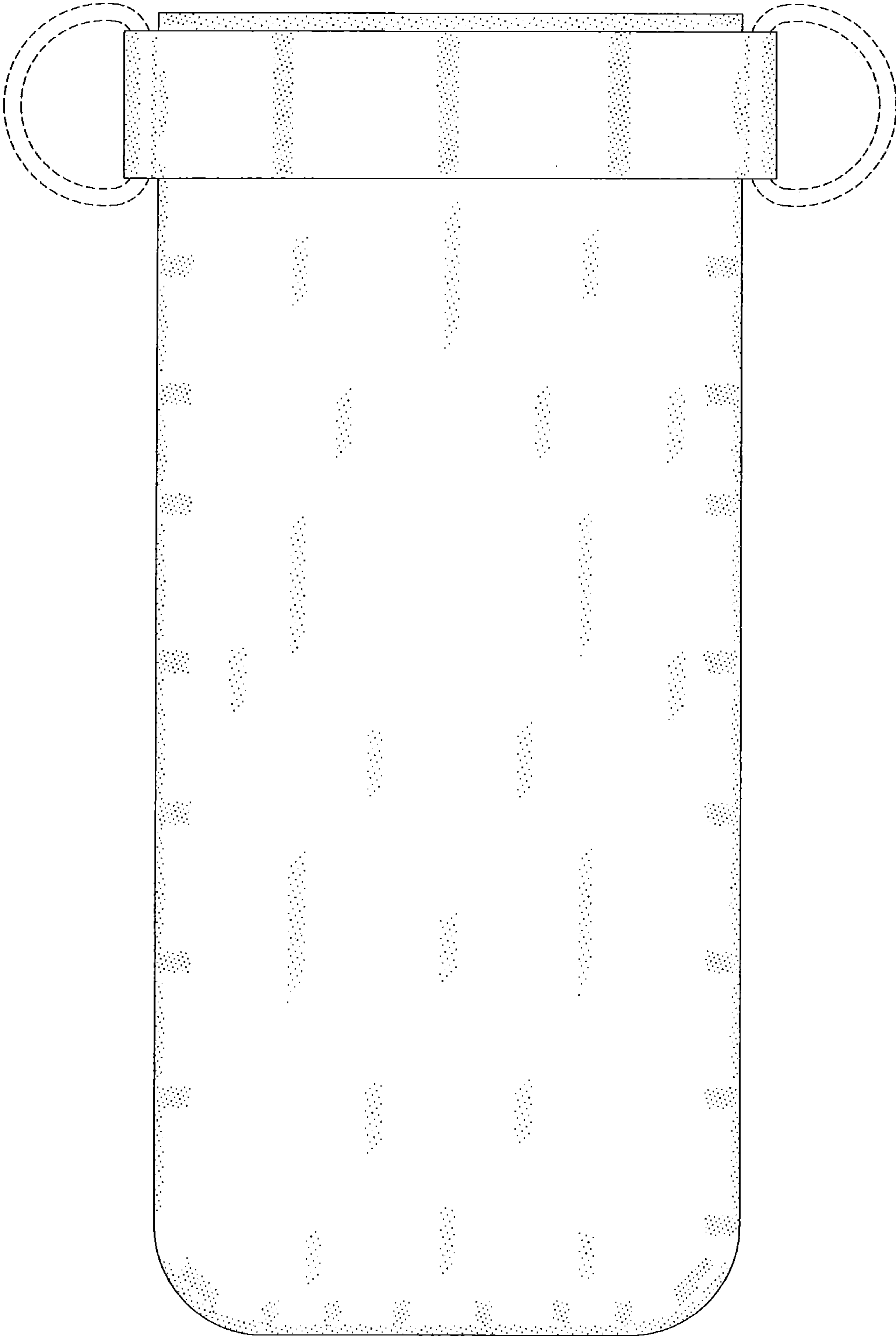

FIG. 10

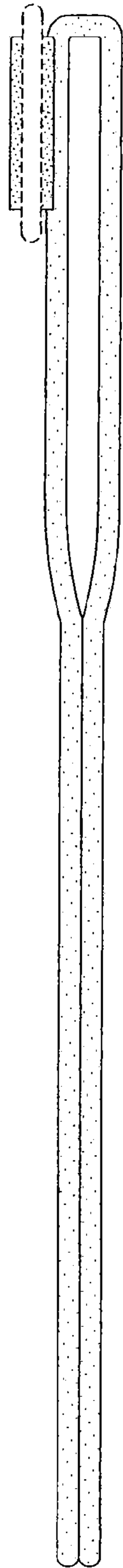

FIG. 11

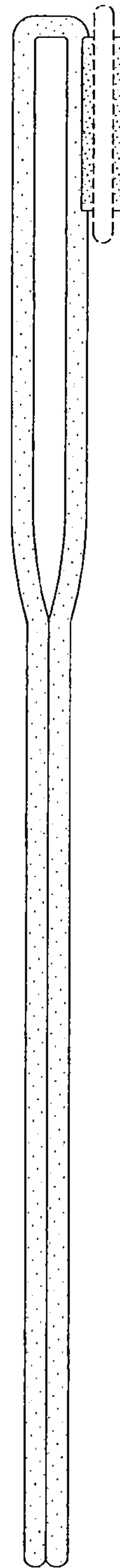

FIG. 12

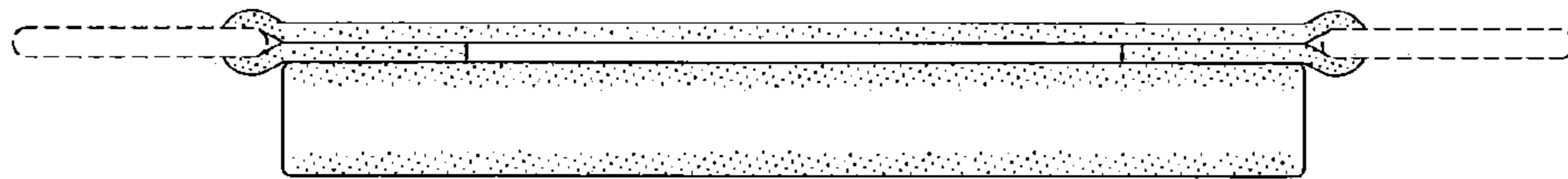

FIG. 13

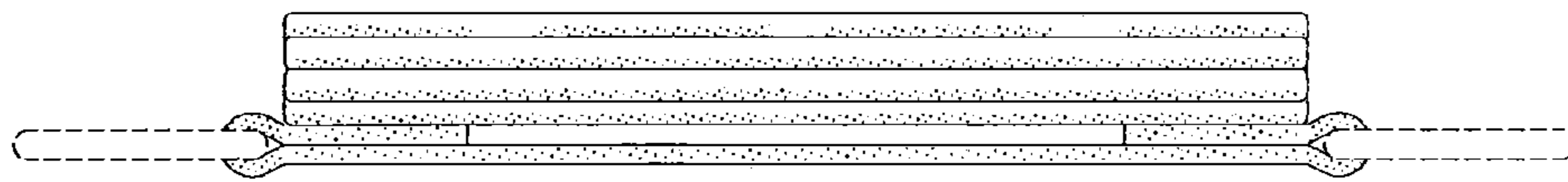

FIG. 14

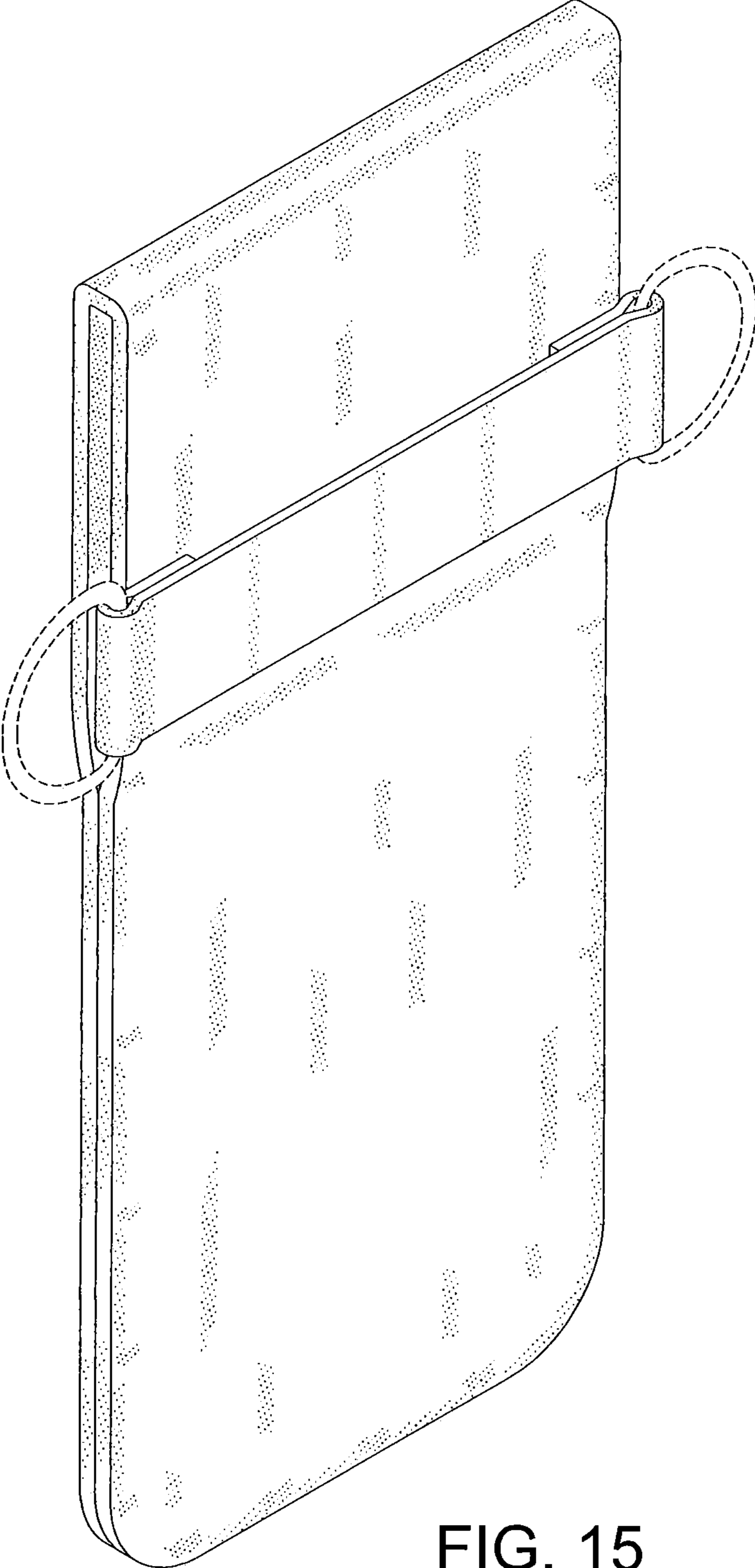

FIG. 15

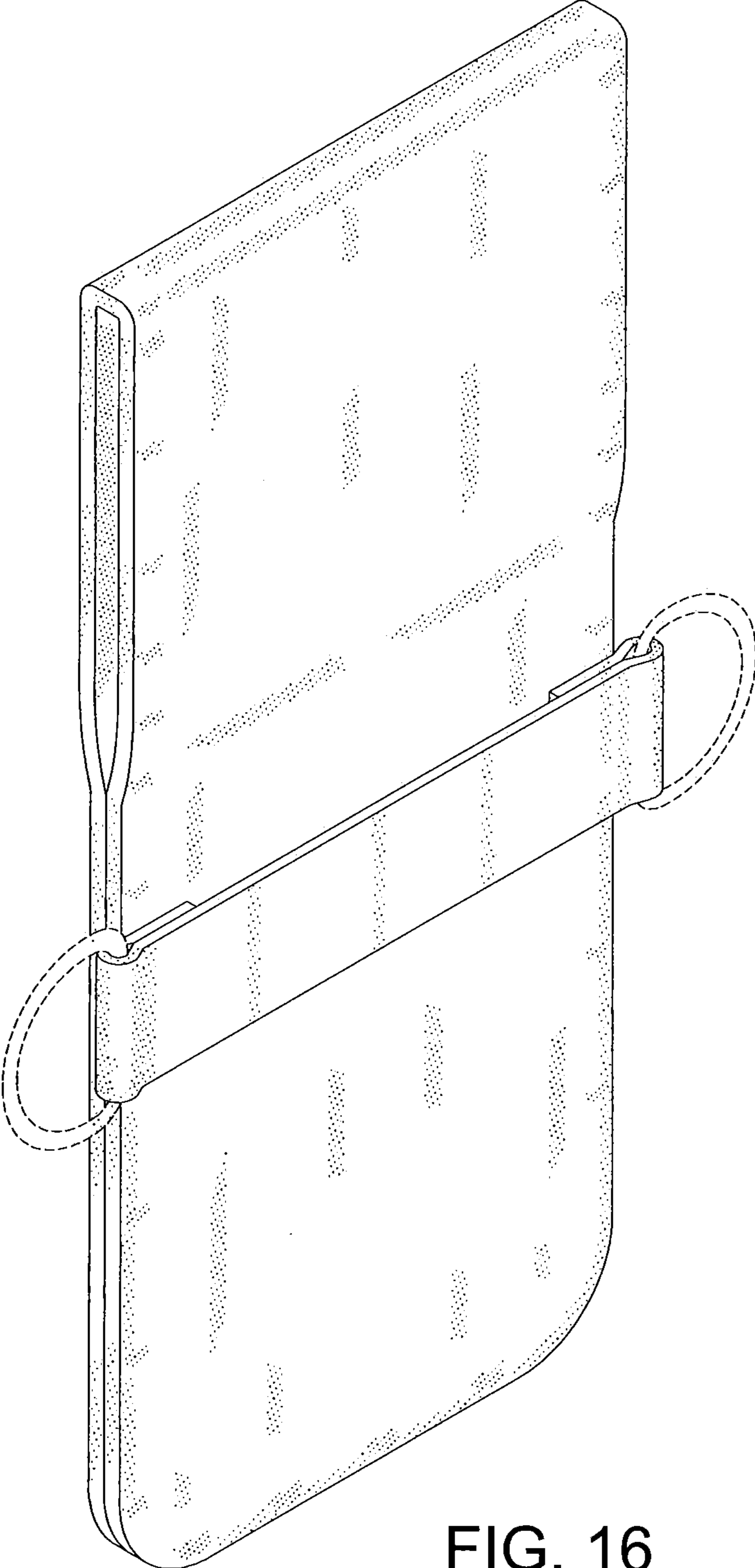

FIG. 16

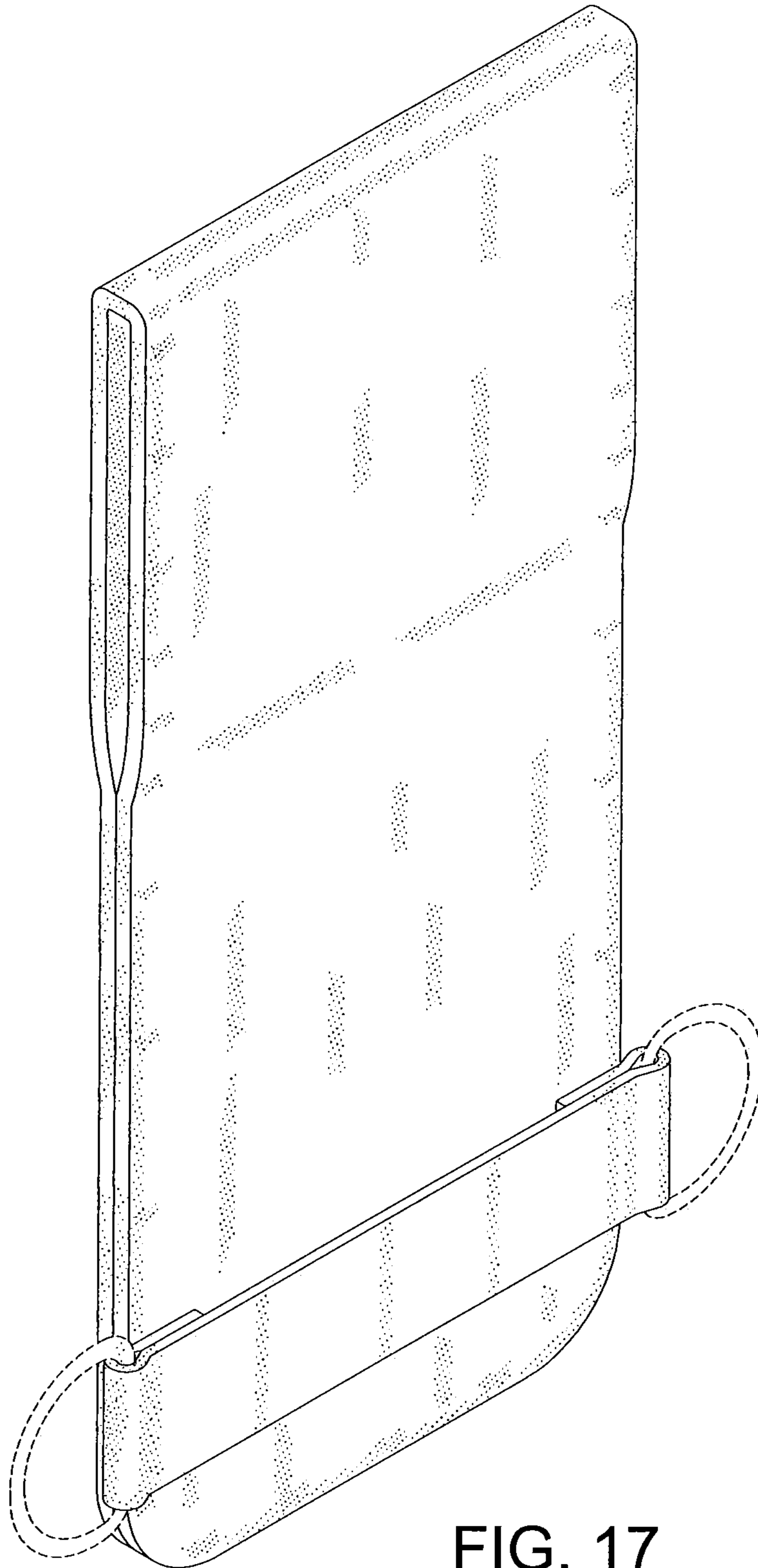

FIG. 17

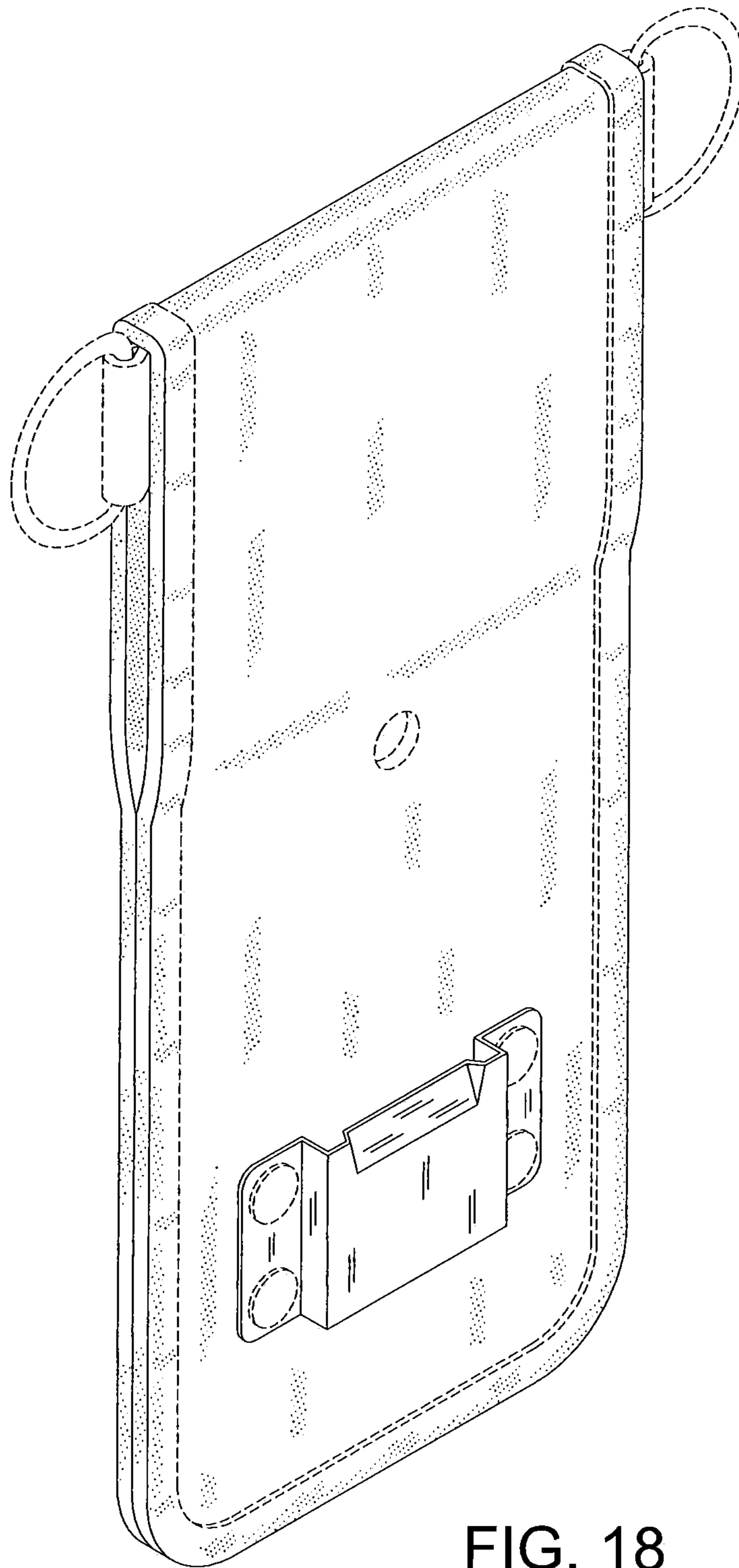

FIG. 18

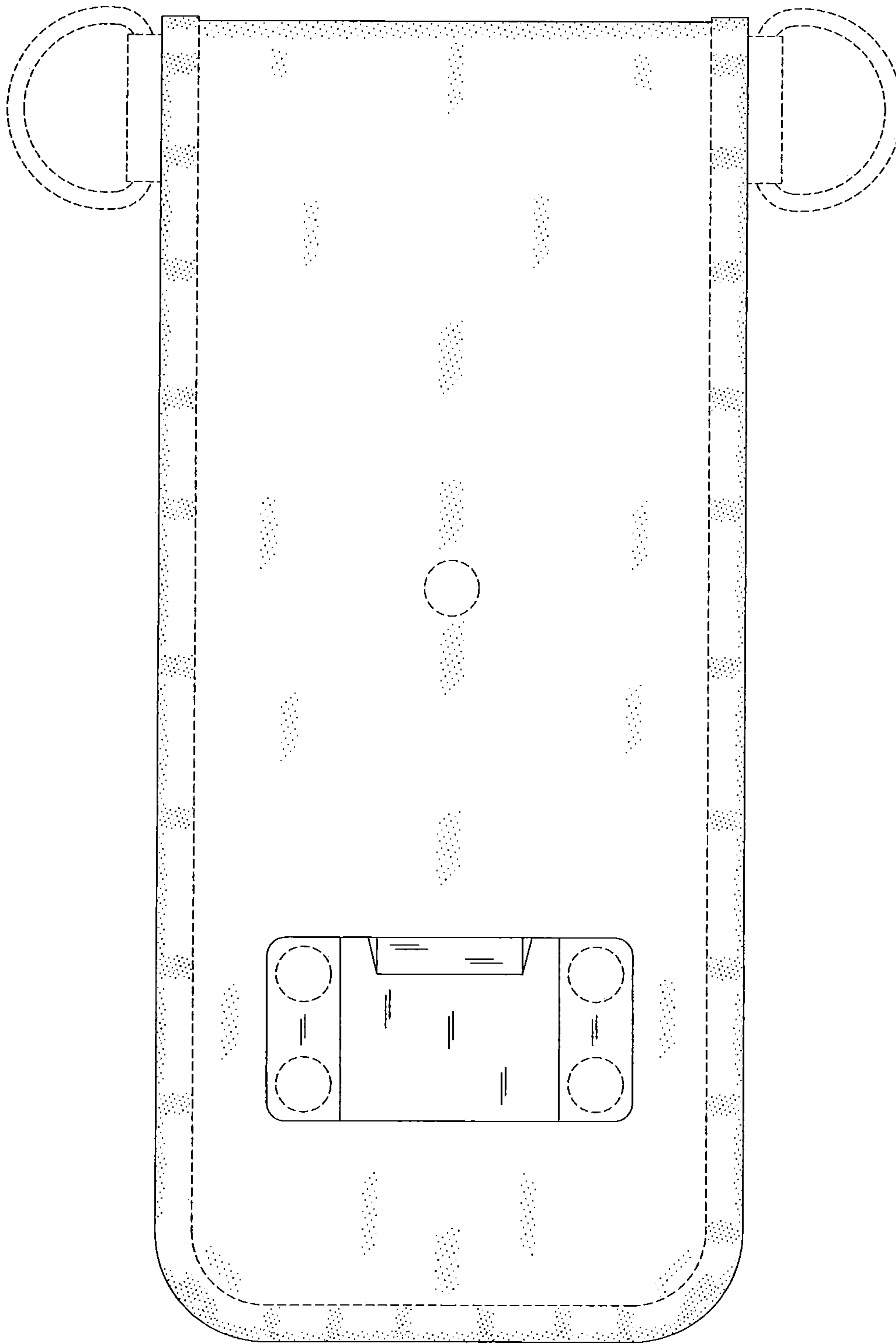

FIG. 19

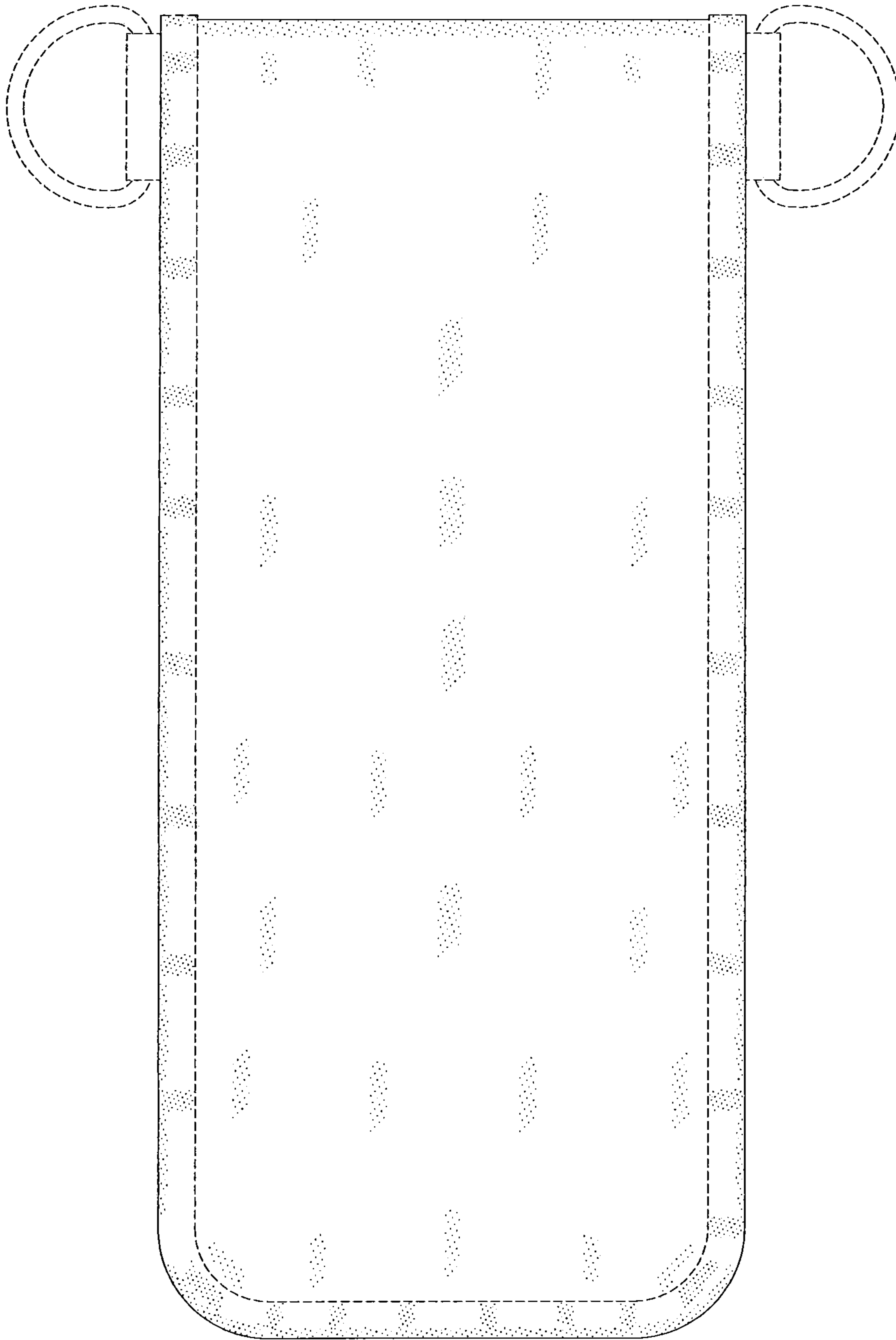

FIG. 20

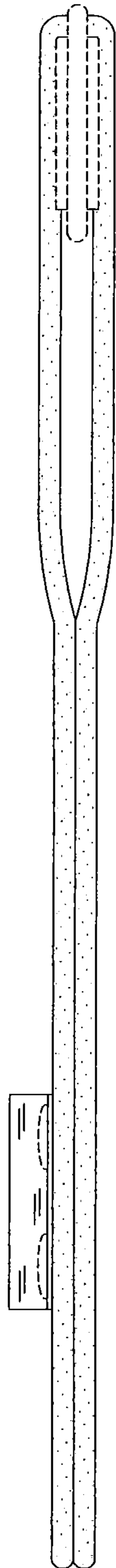

FIG. 21

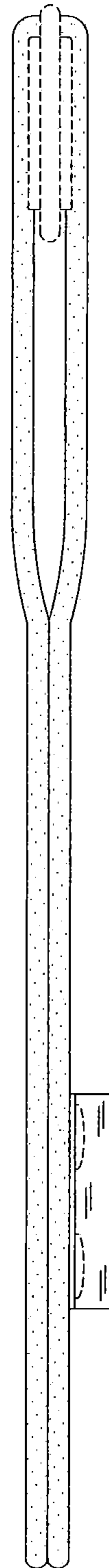

FIG. 22

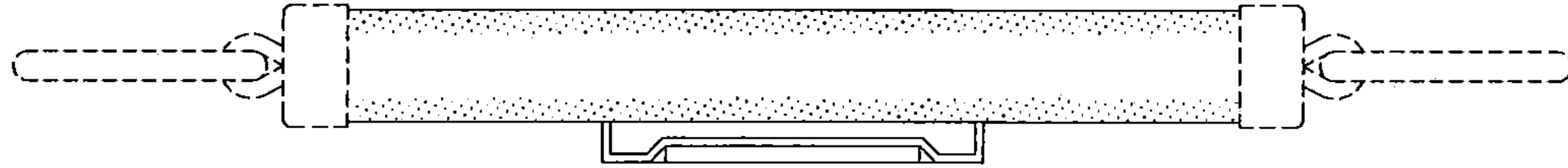

FIG. 23



FIG. 24