



US00D764316S

(12) **United States Design Patent**  
**Fleming et al.**

(10) **Patent No.:** **US D764,316 S**

(45) **Date of Patent:** **\*\* Aug. 23, 2016**

(54) **FLAVOR CONTAINER HOLDER**

(71) Applicants: **Larry Fleming**, Sand Springs, OK (US);  
**Jordan Fleming**, Sand Springs, OK  
(US)

(72) Inventors: **Larry Fleming**, Sand Springs, OK (US);  
**Jordan Fleming**, Sand Springs, OK  
(US)

(\*\*) Term: **14 Years**

(21) Appl. No.: **29/511,451**

(22) Filed: **Dec. 10, 2014**

(51) **LOC (10) Cl.** ..... **09-03**

(52) **U.S. Cl.**  
USPC ..... **D9/756**

(58) **Field of Classification Search**  
USPC ..... D9/414, 424, 456, 756; D7/601, 602,  
D7/600.1, 612, 614, 701; D3/315, 313,  
D3/304; D6/571, 682.2, 683.1, 449, 473,  
D6/474, 477-479, 553, 510, 467;  
D19/90-92, 86, 75, 77, 78, 87; 211/10,  
211/11, 45, 50, 55, 126.1, 126.2, 126.13,  
211/126.16; 312/183, 107  
CPC ..... A47F 3/14; A47F 5/00; A47F 5/0025;  
A47F 5/005  
See application file for complete search history.

(56) **References Cited**

**U.S. PATENT DOCUMENTS**

D68,866 S \* 11/1925 Lester ..... D3/313  
4,015,886 A \* 4/1977 Wickenberg ..... A47B 87/00  
206/509  
D323,766 S \* 2/1992 Robbins ..... D6/553  
D371,729 S \* 7/1996 White ..... D7/600.1  
D381,362 S \* 7/1997 Meyer ..... D19/86  
D535,103 S \* 1/2007 Fischer ..... D3/315  
D547,973 S \* 8/2007 Brown ..... D3/313  
D563,710 S \* 3/2008 Belokin ..... D6/574  
D574,653 S \* 8/2008 Belokin ..... D6/574  
D578,760 S \* 10/2008 Brown ..... D3/304

D651,801 S \* 1/2012 Brown ..... D3/304  
D661,488 S \* 6/2012 Kraemer ..... D3/304  
D674,687 S \* 1/2013 Cote ..... D24/147  
D716,552 S \* 11/2014 Theisen ..... D3/304  
D720,166 S \* 12/2014 Trindall ..... D6/683.1  
2007/0131632 A1 \* 6/2007 Brown ..... A47B 87/0261  
211/126.13  
2008/0272078 A1 \* 11/2008 Belokin ..... A47F 5/08  
211/126.1  
2012/0048818 A1 \* 3/2012 Fiscus ..... A47F 5/0025  
211/71.01

**OTHER PUBLICATIONS**

Organizer Storage Box (via eBay), available Feb. 16, 2016, [online],  
[site visited Mar. 16, 2016]. Available from internet, <URL: [http://www.ebay.com/itm/5-Cells-Plastic-Organizer-Storage-Box-Tie-Bra-Socks-Drawer-Cosmetic-Divider-Box/371555896588?\\_trksid=p2045573.c100507.m3226&\\_trkparms=aid%3D555014%26algo%3DPL.DEFAULT%26ao%3D1%26asc%3D35958%26meid%3Deed.\\*](http://www.ebay.com/itm/5-Cells-Plastic-Organizer-Storage-Box-Tie-Bra-Socks-Drawer-Cosmetic-Divider-Box/371555896588?_trksid=p2045573.c100507.m3226&_trkparms=aid%3D555014%26algo%3DPL.DEFAULT%26ao%3D1%26asc%3D35958%26meid%3Deed.*)>

\* cited by examiner

*Primary Examiner* — Cathron Brooks  
*Assistant Examiner* — Teddy Falloway  
(74) *Attorney, Agent, or Firm* — QuickPatents, LLC; Kevin Prince

(57) **CLAIM**  
We claim the ornamental design for a flavor container holder,  
as shown and described.

**DESCRIPTION**

FIG. 1 is a front perspective view of a flavor container holder,  
showing our new design;  
FIG. 2 is a right-side elevational view thereof, the left-side  
elevational view being a mirror image thereof;  
FIG. 3 is a front elevational view thereof;  
FIG. 4 is a rear elevational view thereof;  
FIG. 5 is a top plan view thereof;  
FIG. 6 is a bottom plan view thereof; and,  
FIG. 7 is a rear perspective view thereof.

**1 Claim, 4 Drawing Sheets**

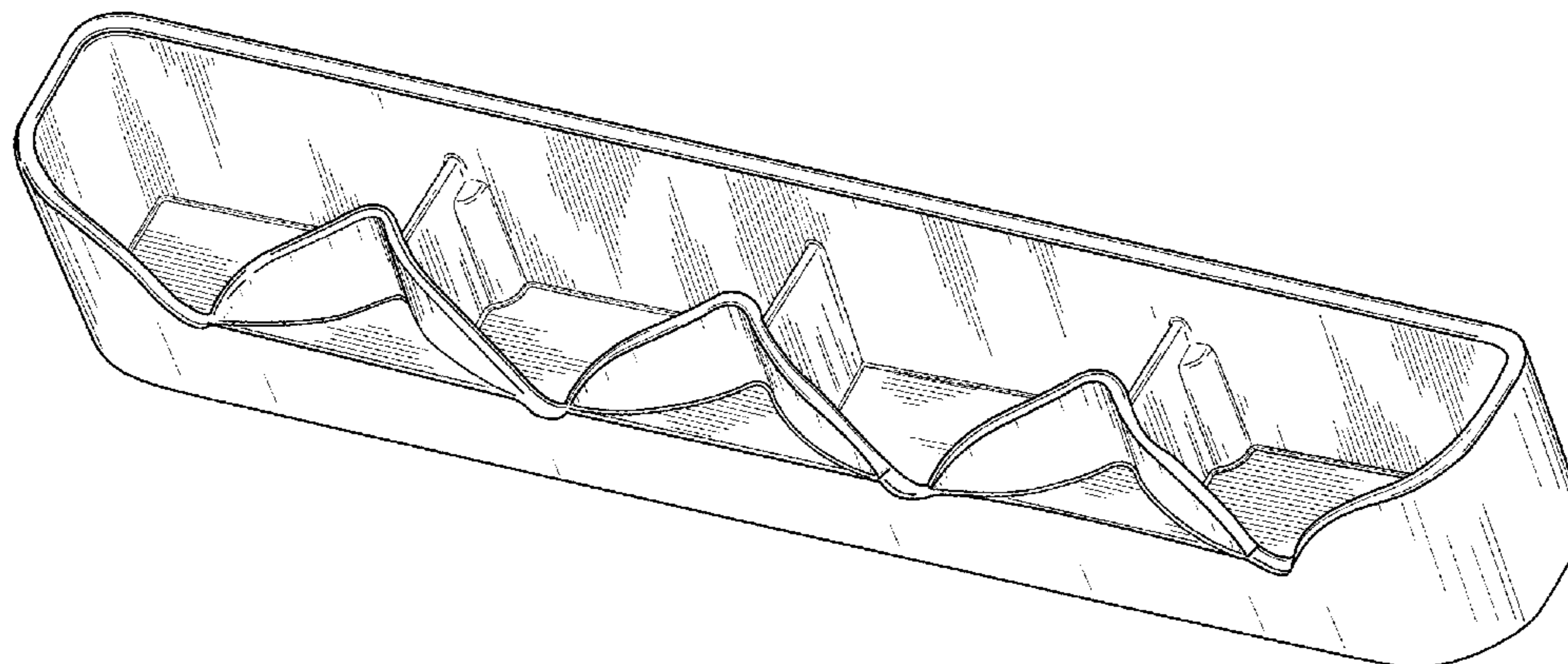

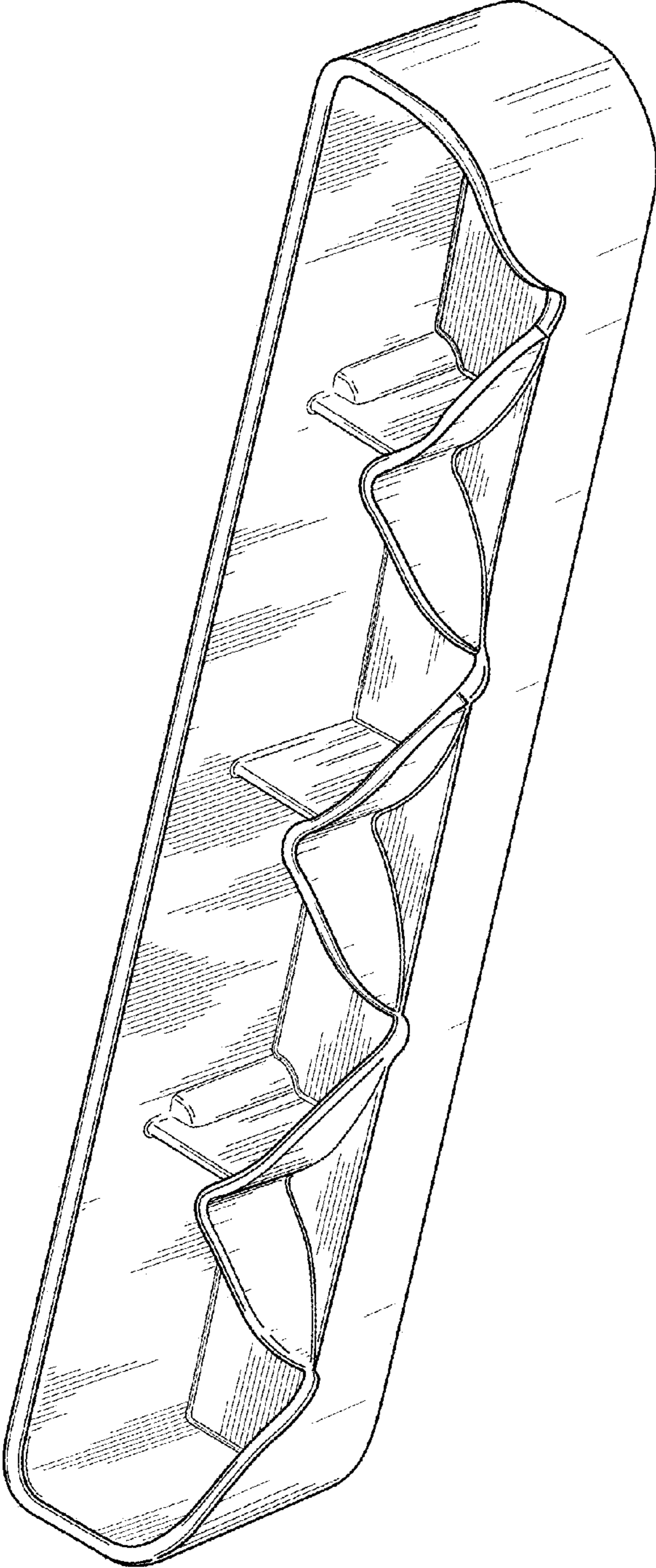

FIG. 1

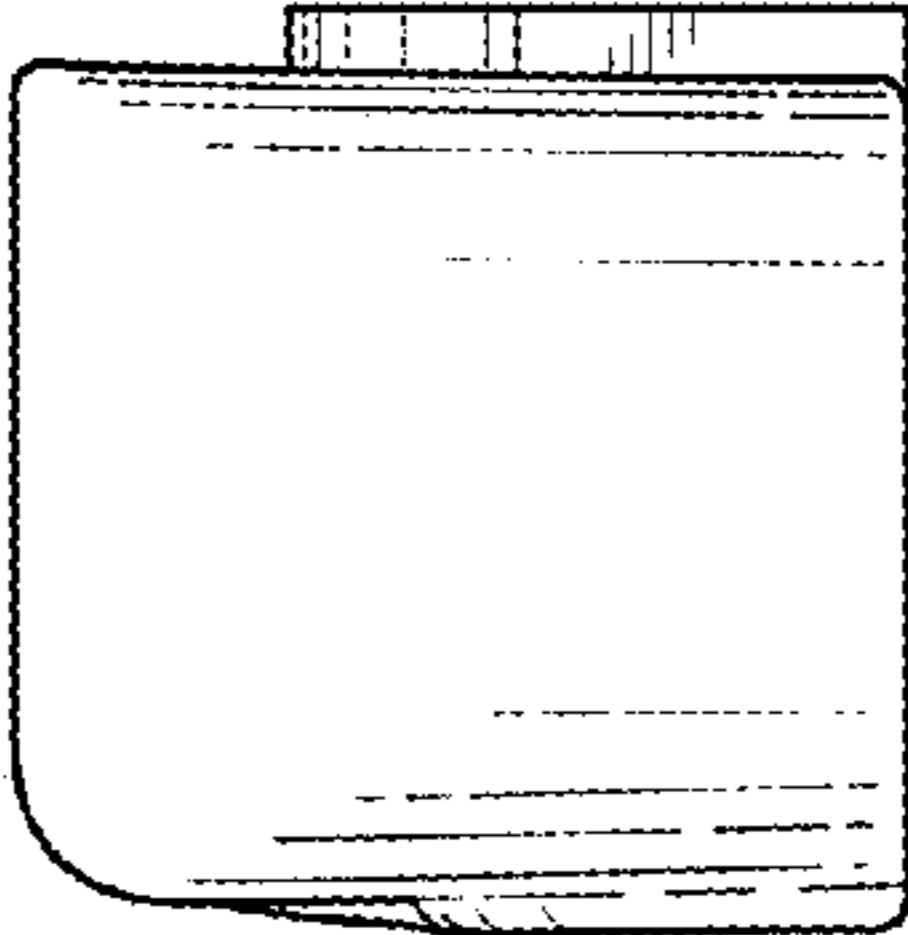

FIG. 2

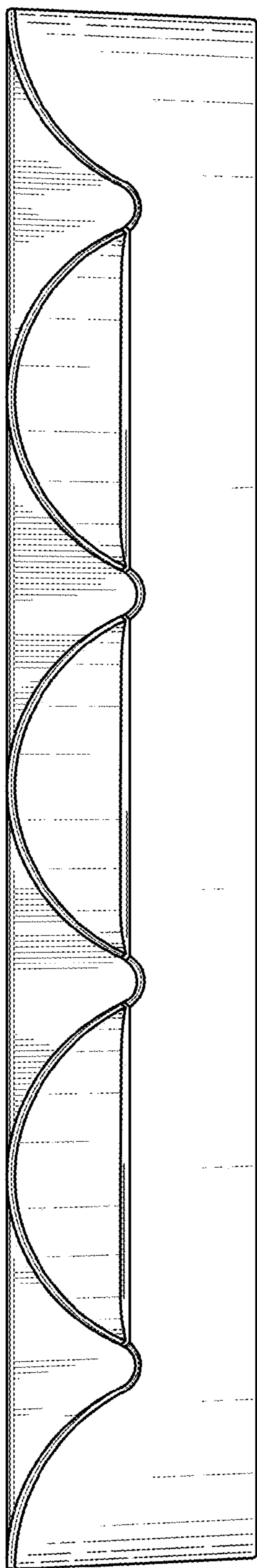

FIG. 3

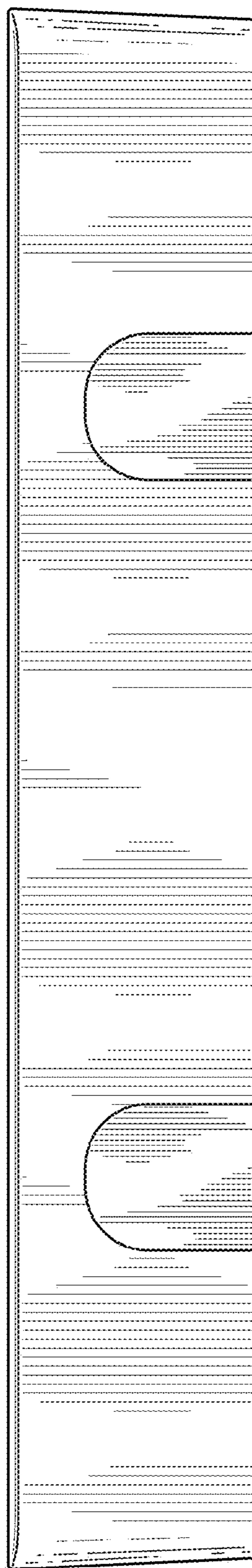

FIG. 4



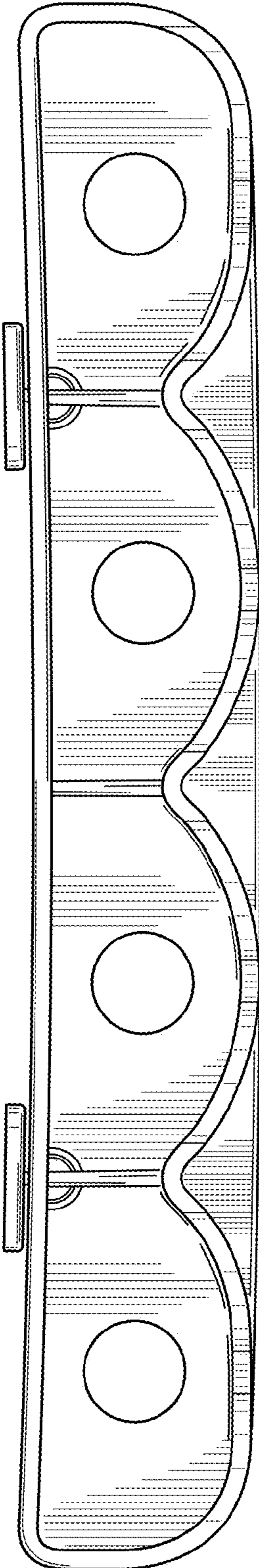

FIG. 5

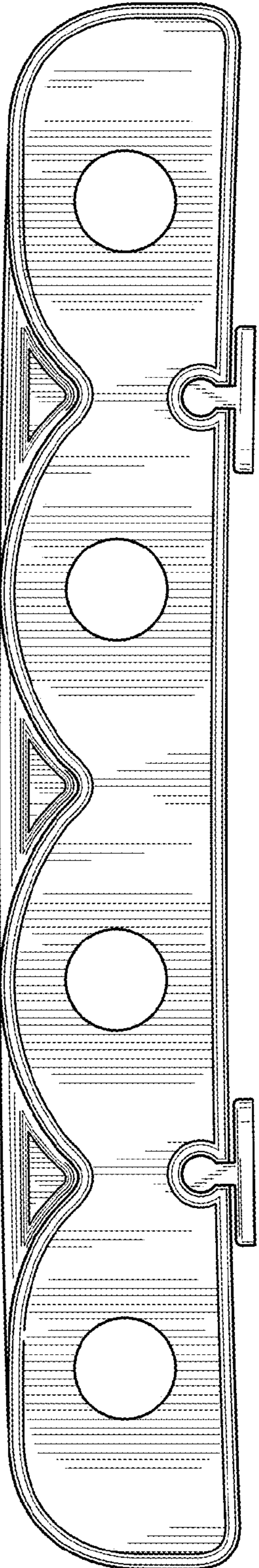

FIG. 6

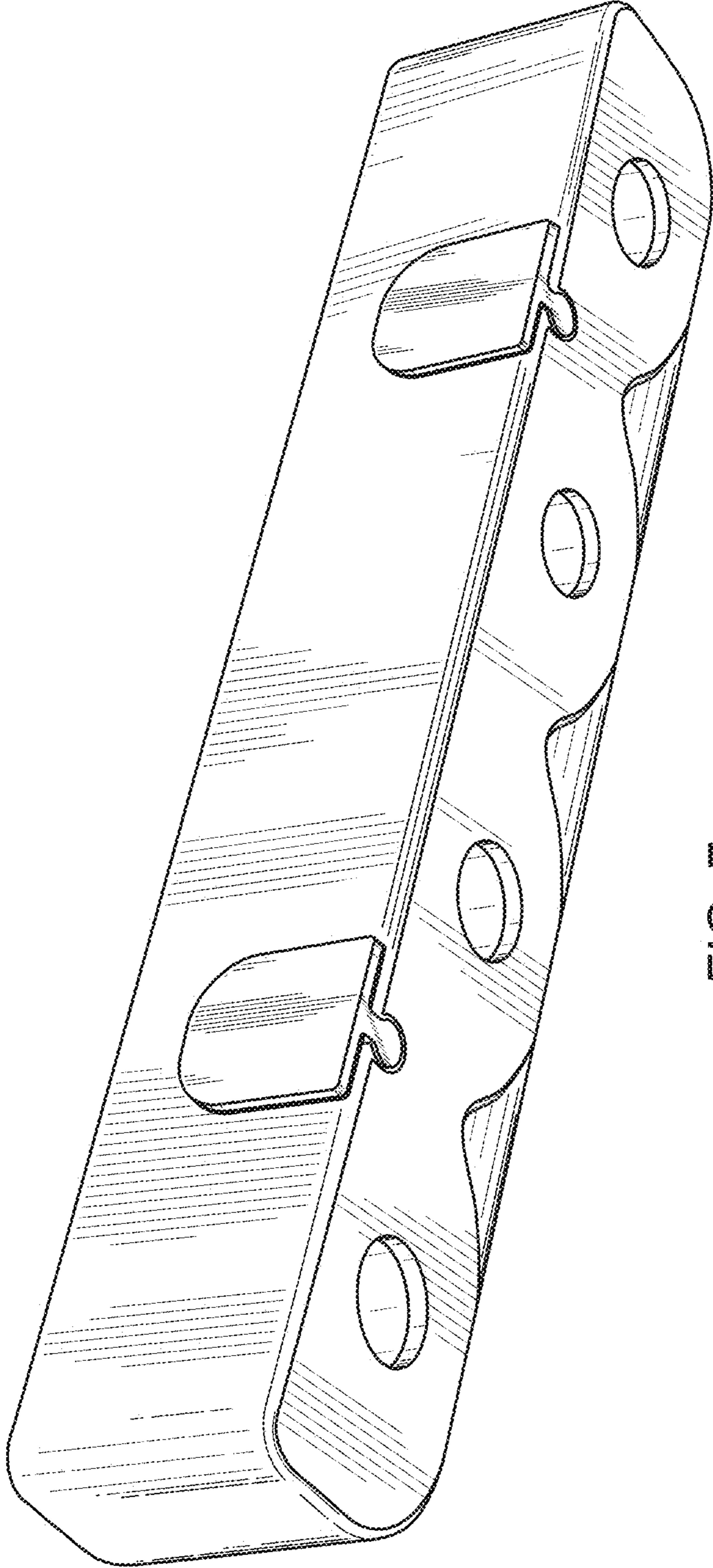

FIG. 7