



US00D764284S

(12) **United States Design Patent**
Mohn et al.

(10) **Patent No.:** **US D764,284 S**

(45) **Date of Patent:** **** Aug. 23, 2016**

(54) **PACKAGING**

(71) Applicant: **IPI S.R.L.**, San Sisto (Perugia) (IT)

(72) Inventors: **Arne Mohn**, Rome (IT); **Luca Moroni**, Perugia (IT)

(73) Assignee: **IPI S.R.L.**, San Sisto (IT)

(**) Term: **14 Years**

(21) Appl. No.: **29/500,045**

(22) Filed: **Aug. 21, 2014**

Related U.S. Application Data

(62) Division of application No. 29/419,243, filed on Apr. 26, 2012, now Pat. No. Des. 714,638.

(30) **Foreign Application Priority Data**

Oct. 27, 2011	(EM)	001938986-0001
Oct. 27, 2011	(EM)	001938986-0002
Oct. 27, 2011	(EM)	001938986-0003
Oct. 27, 2011	(EM)	001938986-0004
Oct. 27, 2011	(EM)	001938986-0005
Oct. 27, 2011	(EM)	001938986-0006
Oct. 27, 2011	(EM)	001938986-0007
Oct. 27, 2011	(EM)	001938986-0008

(51) **LOC (10) Cl.** **09-03**

(52) **U.S. Cl.**
USPC **D9/432**

(58) **Field of Classification Search**
USPC D9/430-434, 414, 420-424, 707-708;
D3/272, 273, 302; D7/601, 602
CPC B65D 5/00; B65D 5/0209; B65D 5/029;
B65D 5/40; B65D 5/72; B65D 5/727
See application file for complete search history.

(56) **References Cited**

U.S. PATENT DOCUMENTS

D357,179	S	*	4/1995	Nedstedt	D9/417
5,938,107	A	*	8/1999	Anchor	B65D 3/08 229/109
D448,286	S		9/2001	Quensel et al.		
D454,063	S		3/2002	Dammers		
D454,492	S		3/2002	Dammers		
D464,566	S		10/2002	Anchor et al.		
D473,464	S	*	4/2003	Anchor	D9/432
D480,966	S	*	10/2003	Iwano	D9/432
D494,861	S		8/2004	Guidotti et al.		
D519,832	S		5/2006	Demathieu et al.		

(Continued)

Primary Examiner — Vy Koenig

(74) *Attorney, Agent, or Firm* — Pearne & Gordon LLP

(57) **CLAIM**

The ornamental design for a packaging, as shown and described.

DESCRIPTION

FIG. 1 is a front-left perspective view of a first embodiment of a packaging, showing our new design;
FIG. 2 is a front elevational view thereof;
FIG. 3 is a right side elevational view thereof;
FIG. 4 is a back elevational view thereof;
FIG. 5 is a left side elevational view thereof;
FIG. 6 is a top plan view thereof;
FIG. 7 is a bottom plan view thereof;
FIG. 8 is a front-left perspective view of a second embodiment of a packaging, according to the invention;
FIG. 9 is a front elevational view thereof;
FIG. 10 is a right side elevational view thereof;
FIG. 11 is a back elevational view thereof;
FIG. 12 is a left side elevational view thereof;
FIG. 13 is a top plan view thereof; and,
FIG. 14 is a bottom plan view thereof.

1 Claim, 8 Drawing Sheets

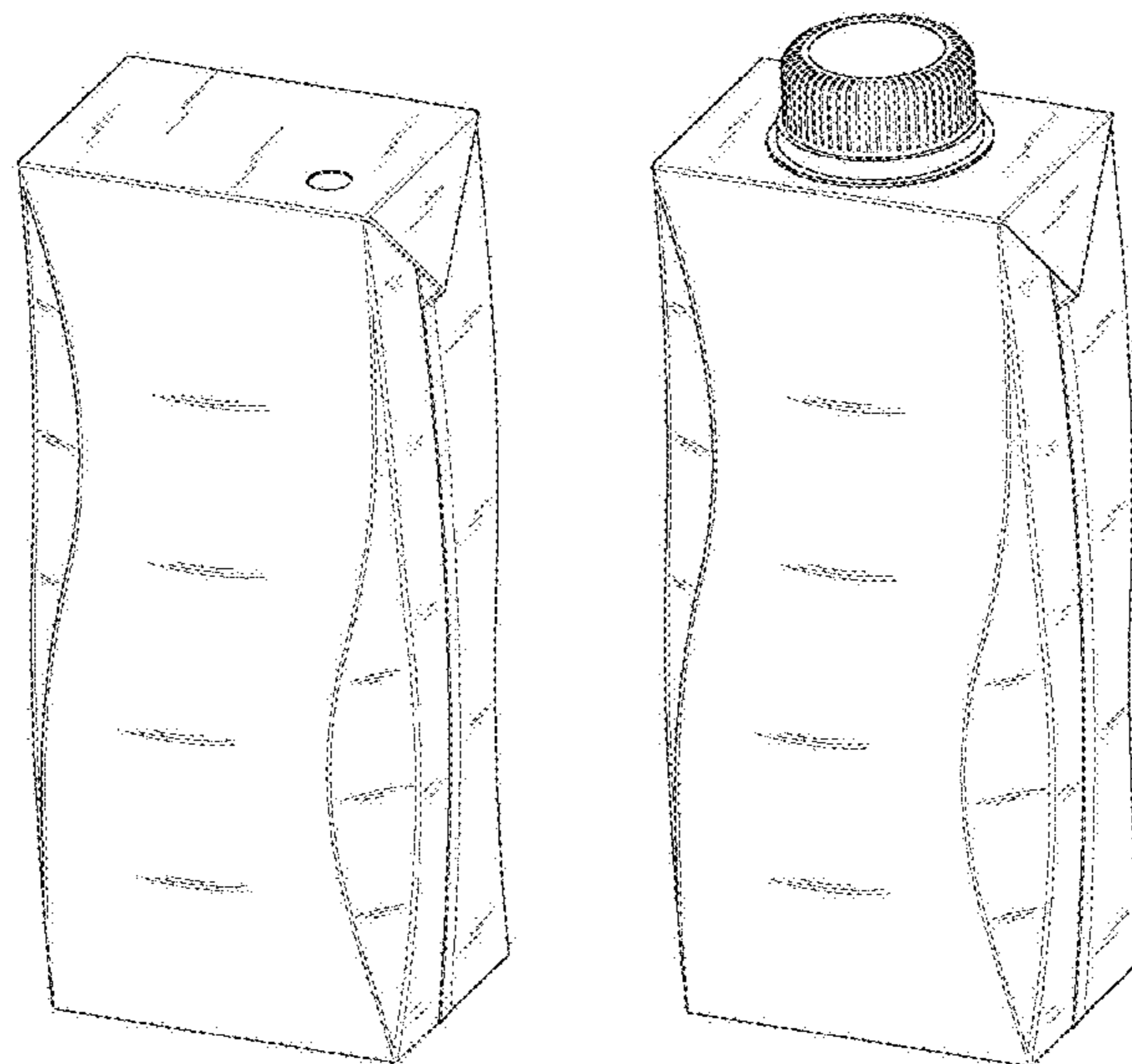

(56)

References Cited

U.S. PATENT DOCUMENTS

D540,164 S 4/2007 Franic
D589,343 S 3/2009 Bohache et al.
D598,745 S 8/2009 Bohache et al.
D624,404 S 9/2010 Darbonne
D635,018 S 3/2011 Wallace et al.
D649,451 S 11/2011 Franic

D665,258 S 8/2012 Wilkum et al.
D677,565 S 3/2013 Barbieri et al.
D684,853 S 6/2013 Dagnino et al.
D691,882 S 10/2013 Barbieri et al.
D714,638 S * 10/2014 Mohn D9/432
D715,640 S * 10/2014 Okezawa D9/430
D748,470 S * 2/2016 Mohn D9/432

* cited by examiner

FIG. 1

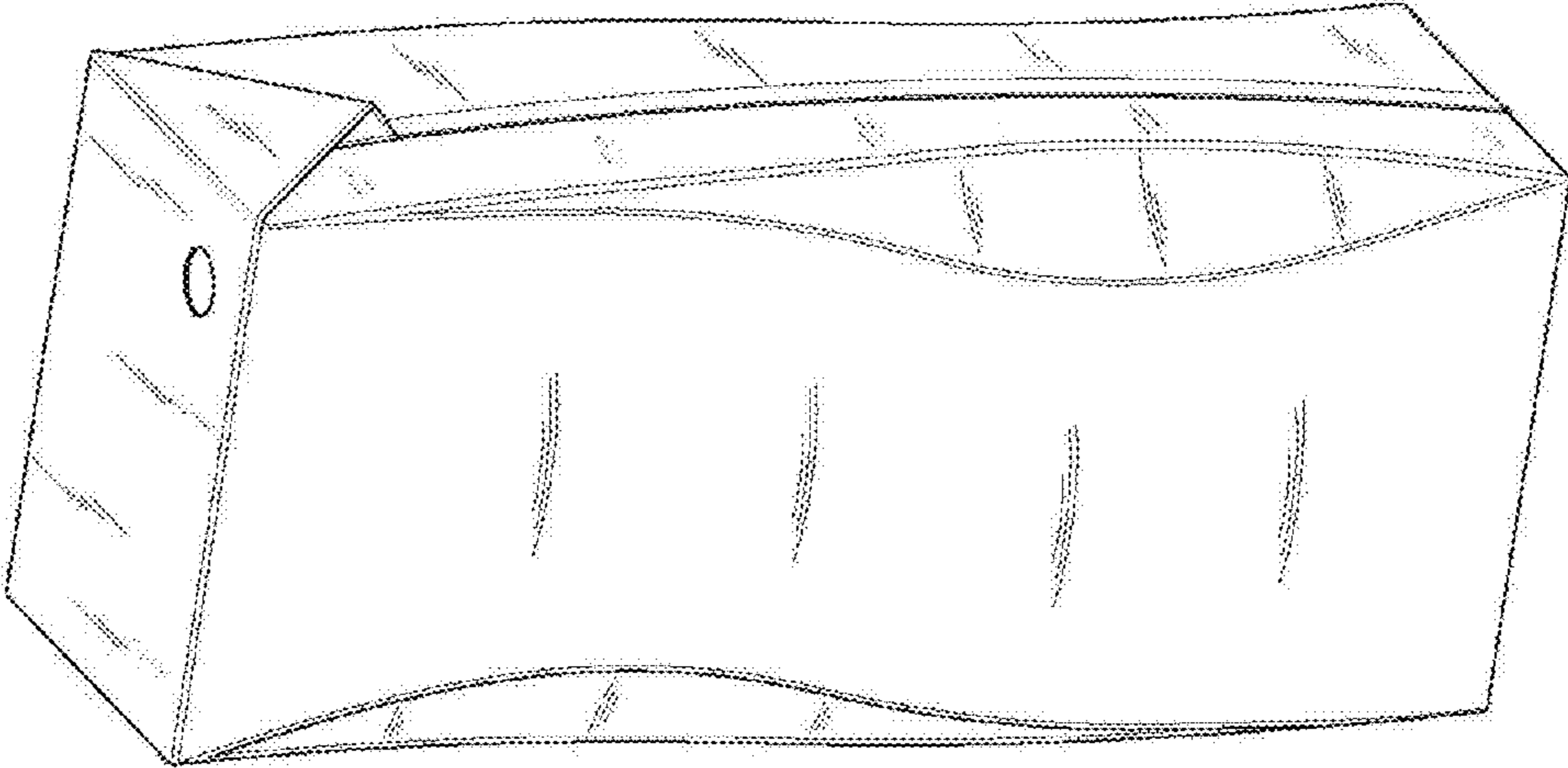

FIG. 3

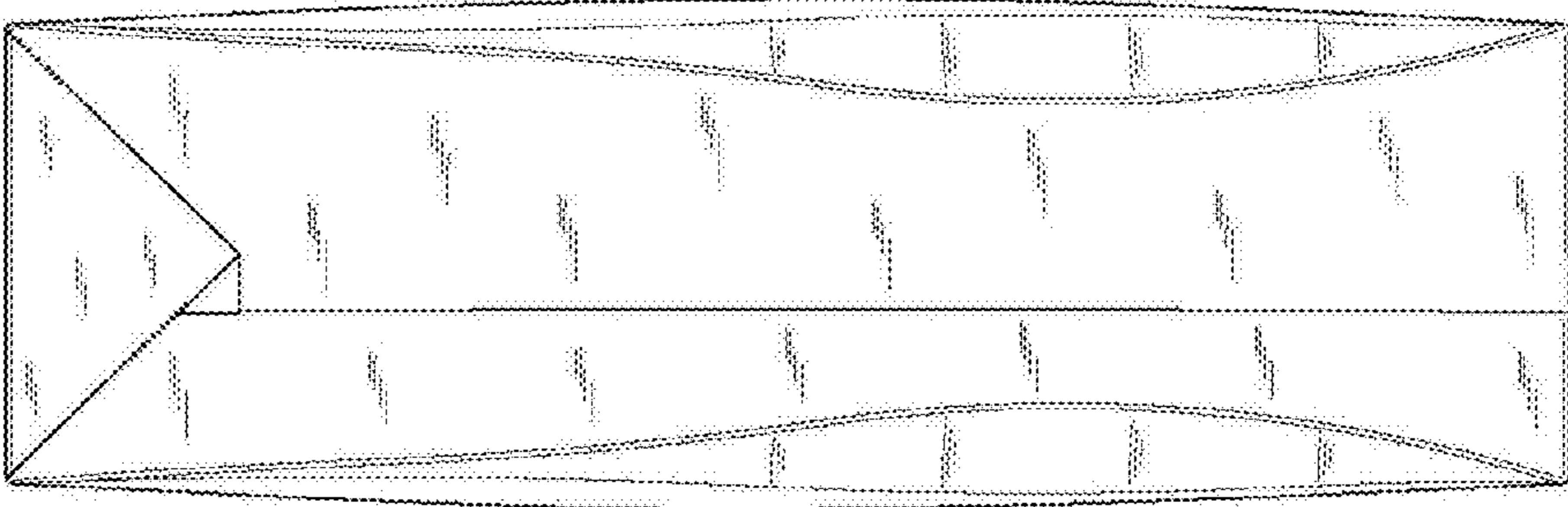

FIG. 2

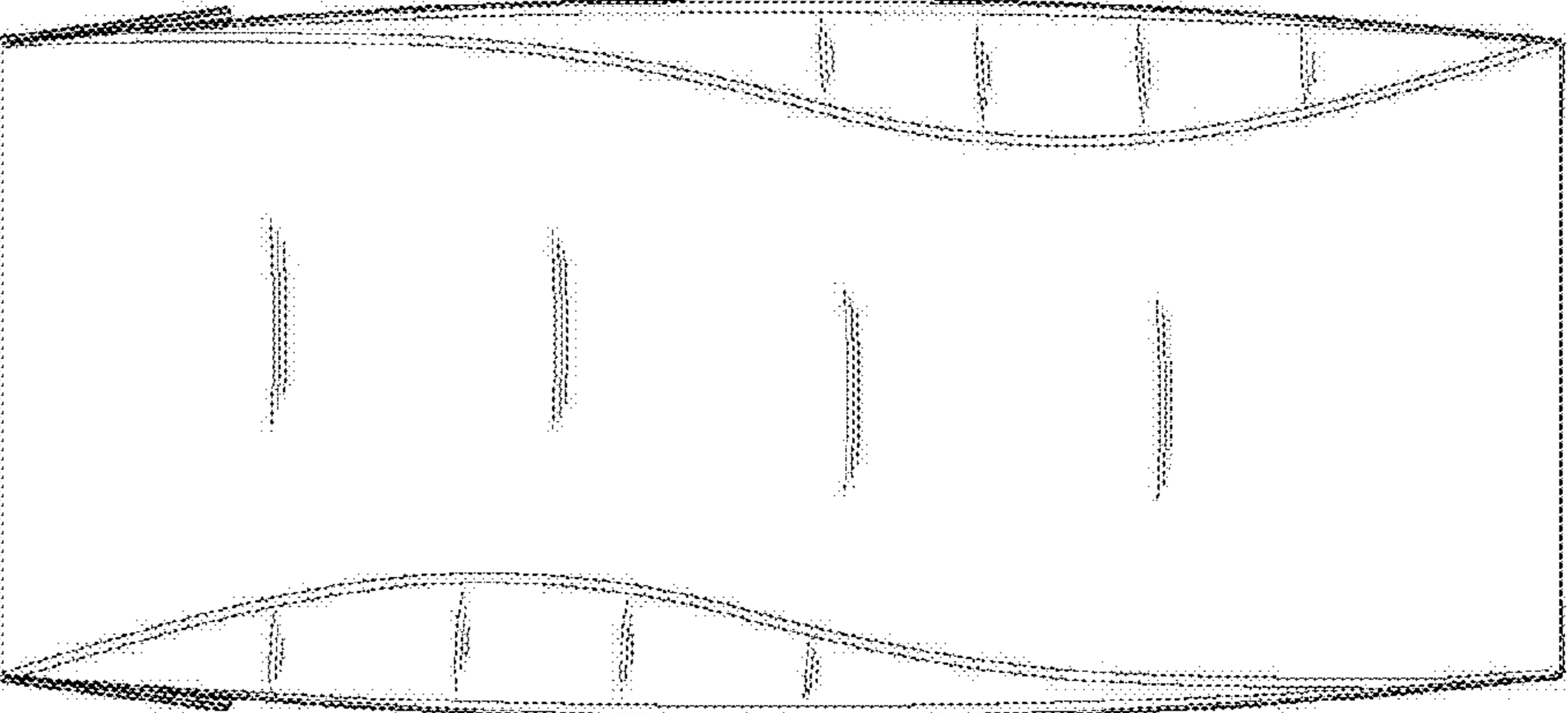

FIG. 5

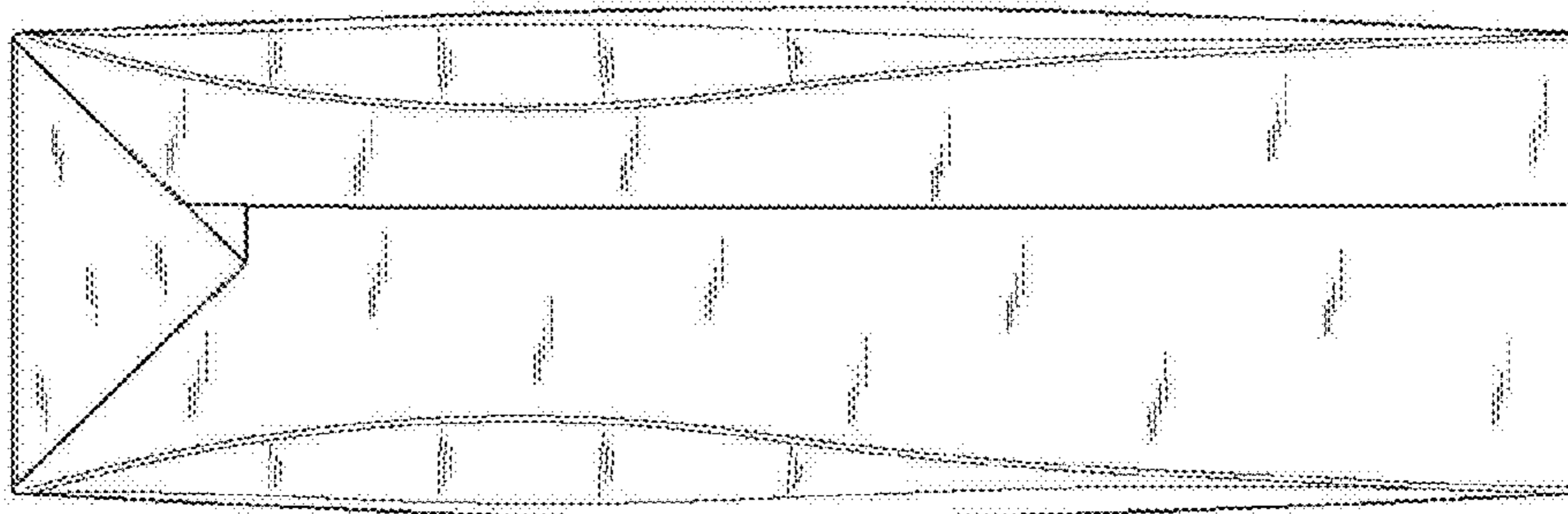

FIG. 4

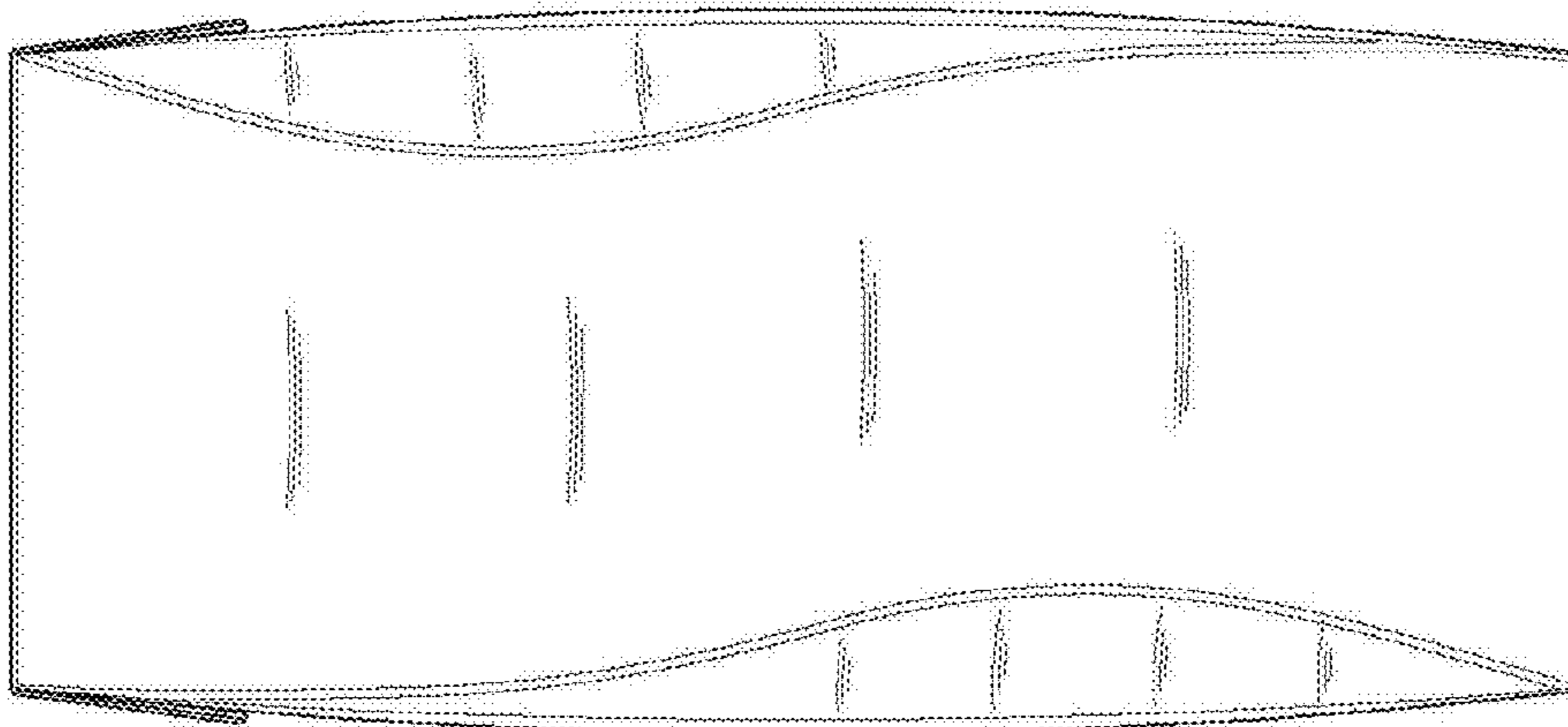

FIG. 7

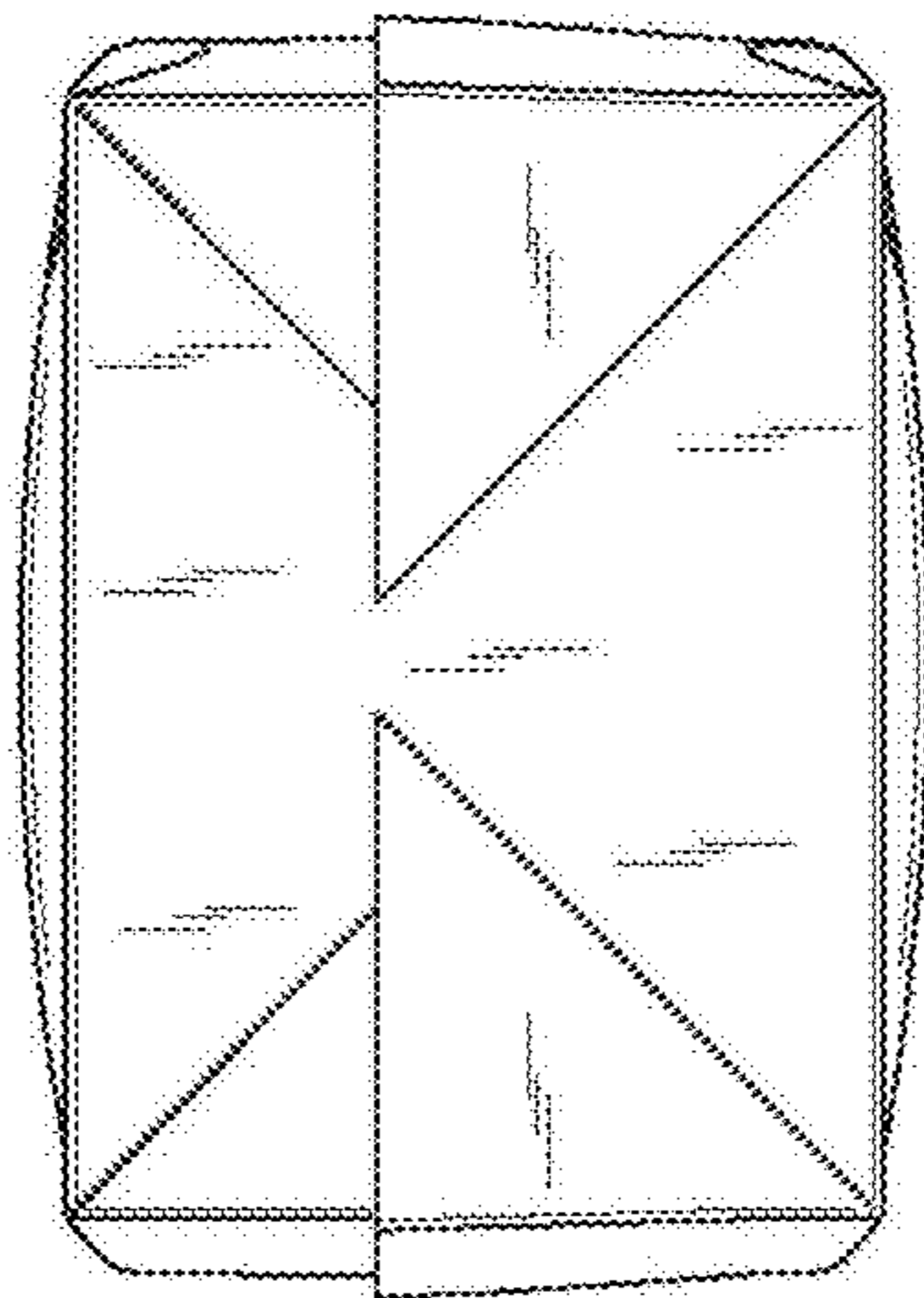

FIG. 6

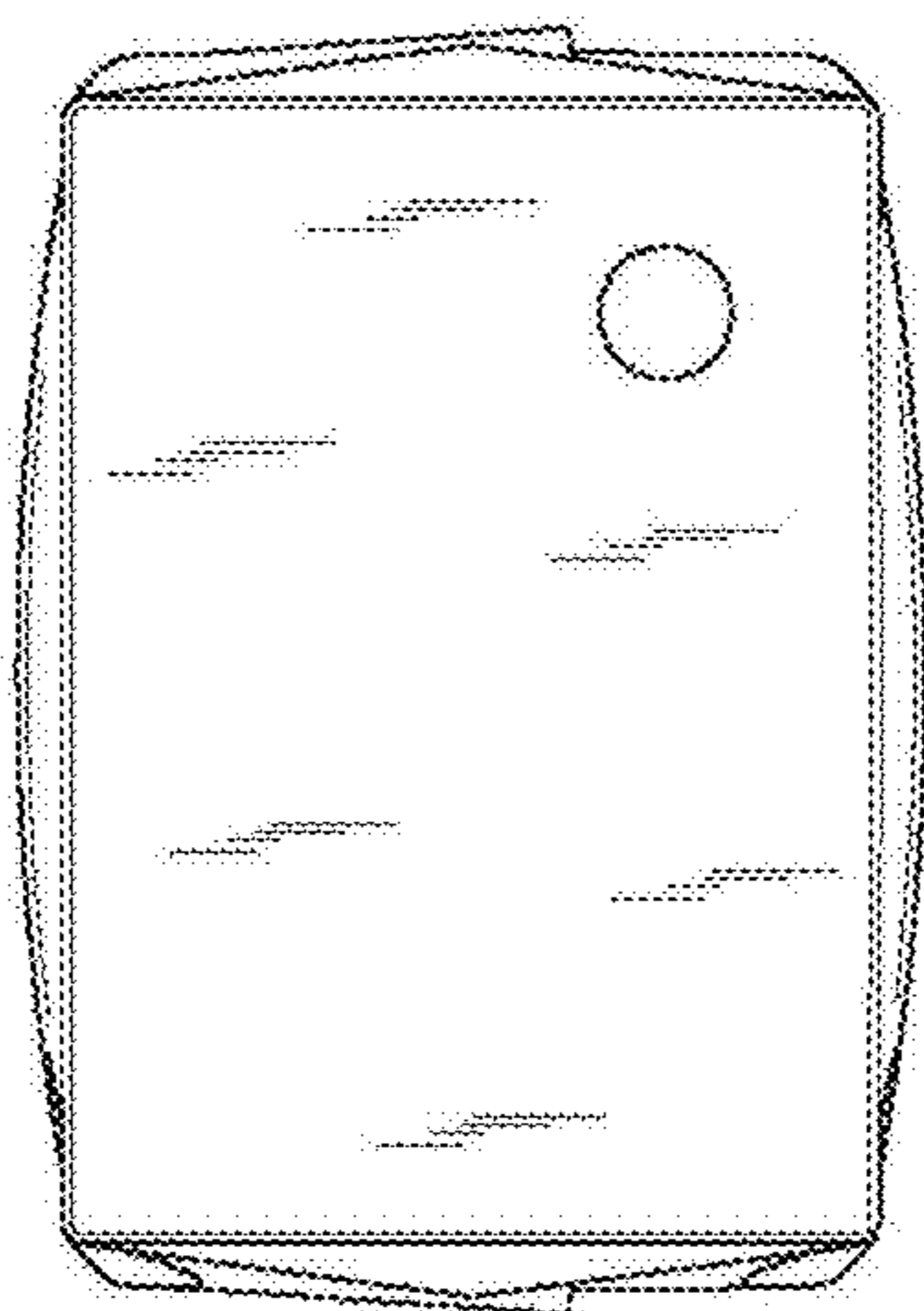

FIG. 8

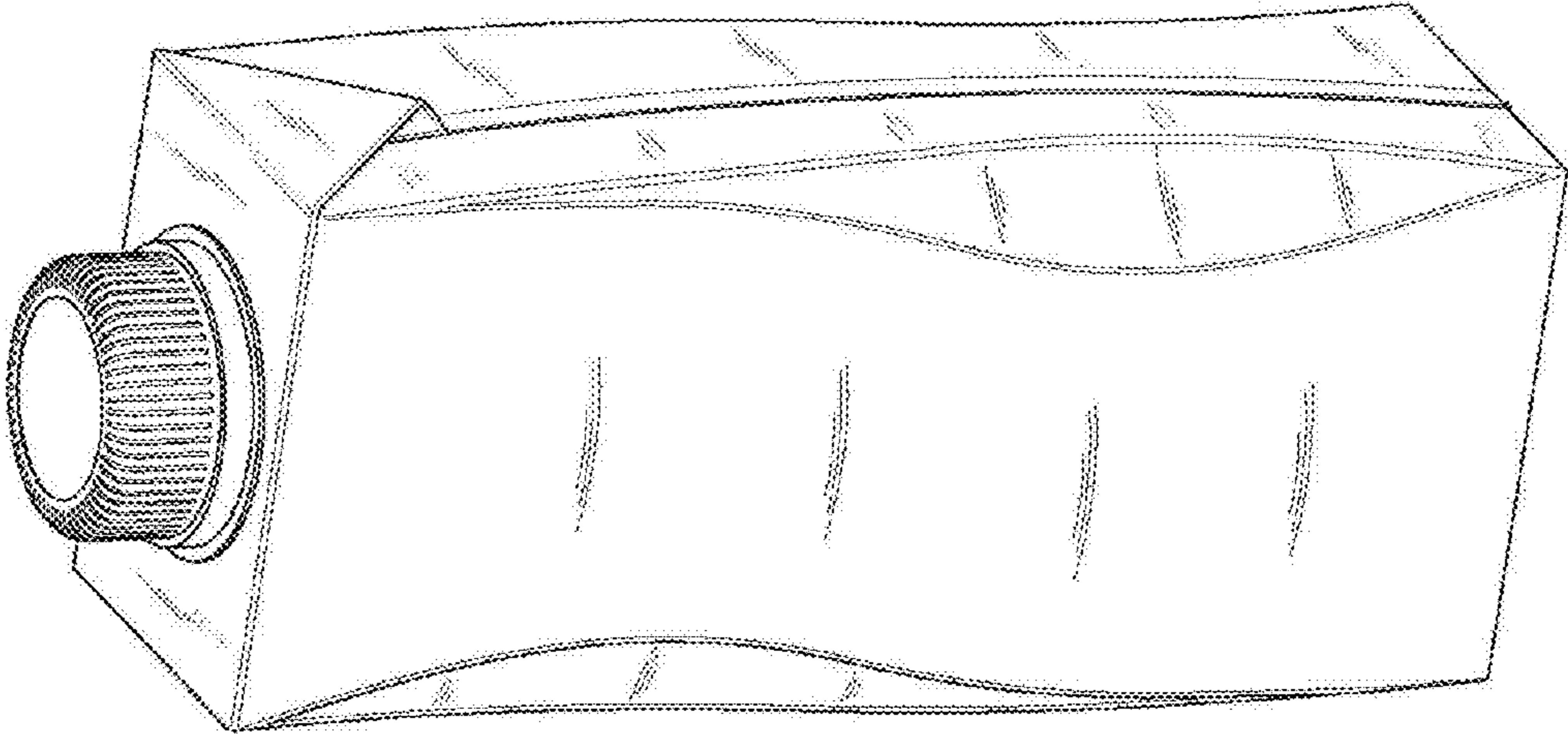

FIG. 10

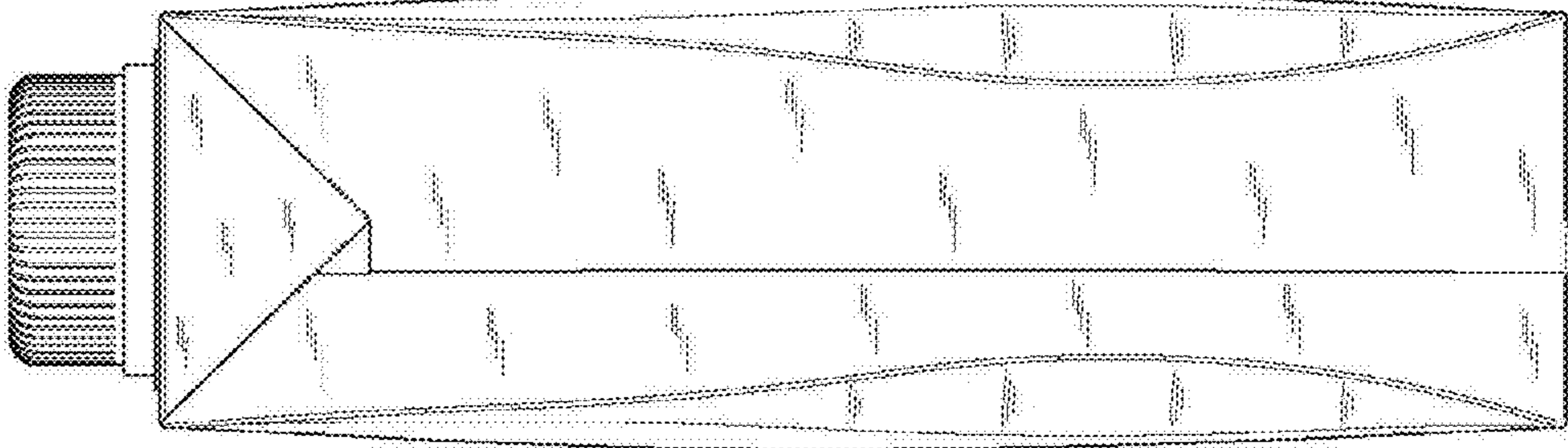

FIG. 9

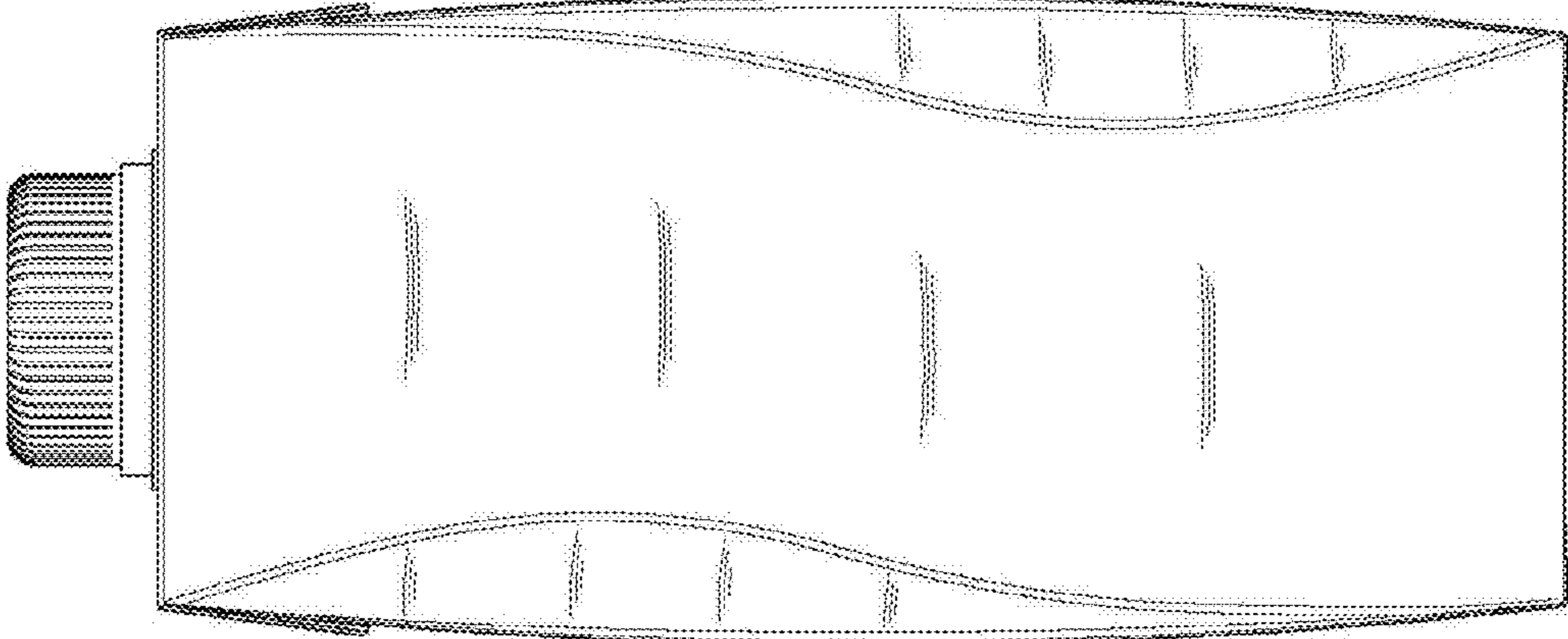

FIG. 12

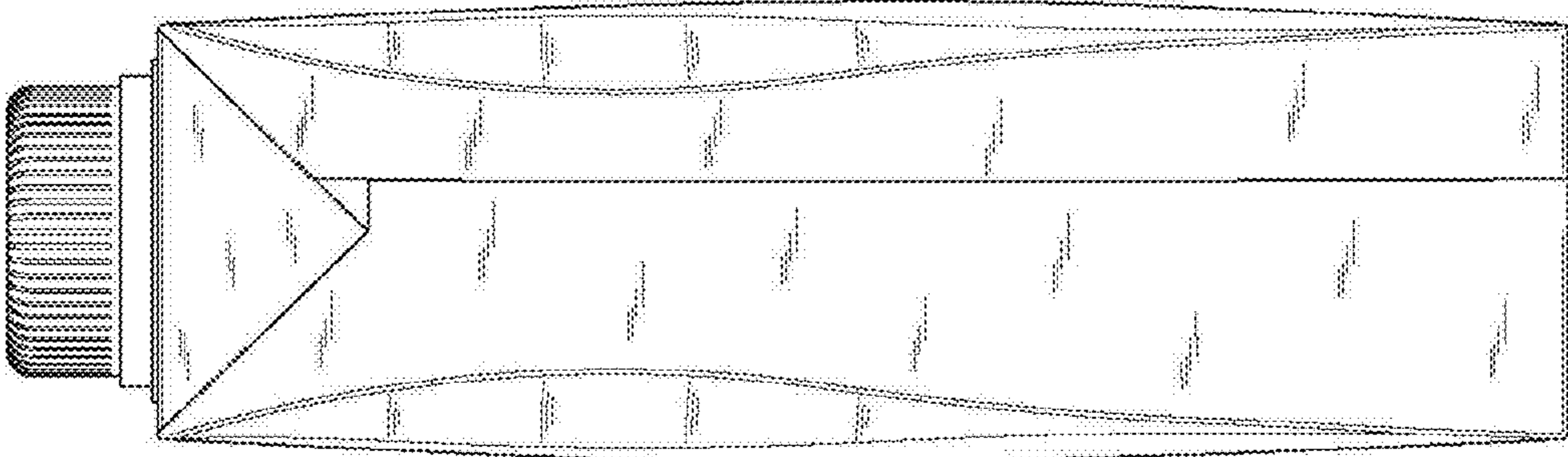

FIG. 11

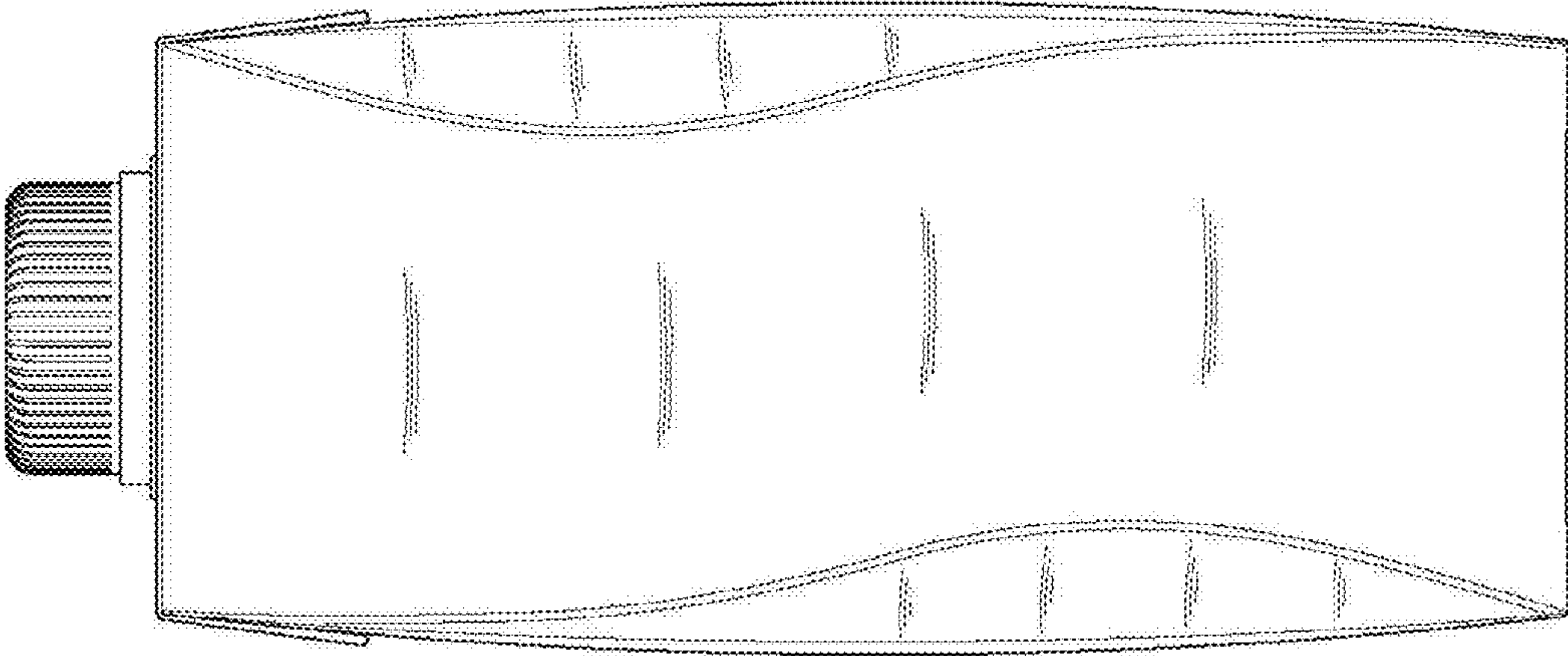

FIG. 14

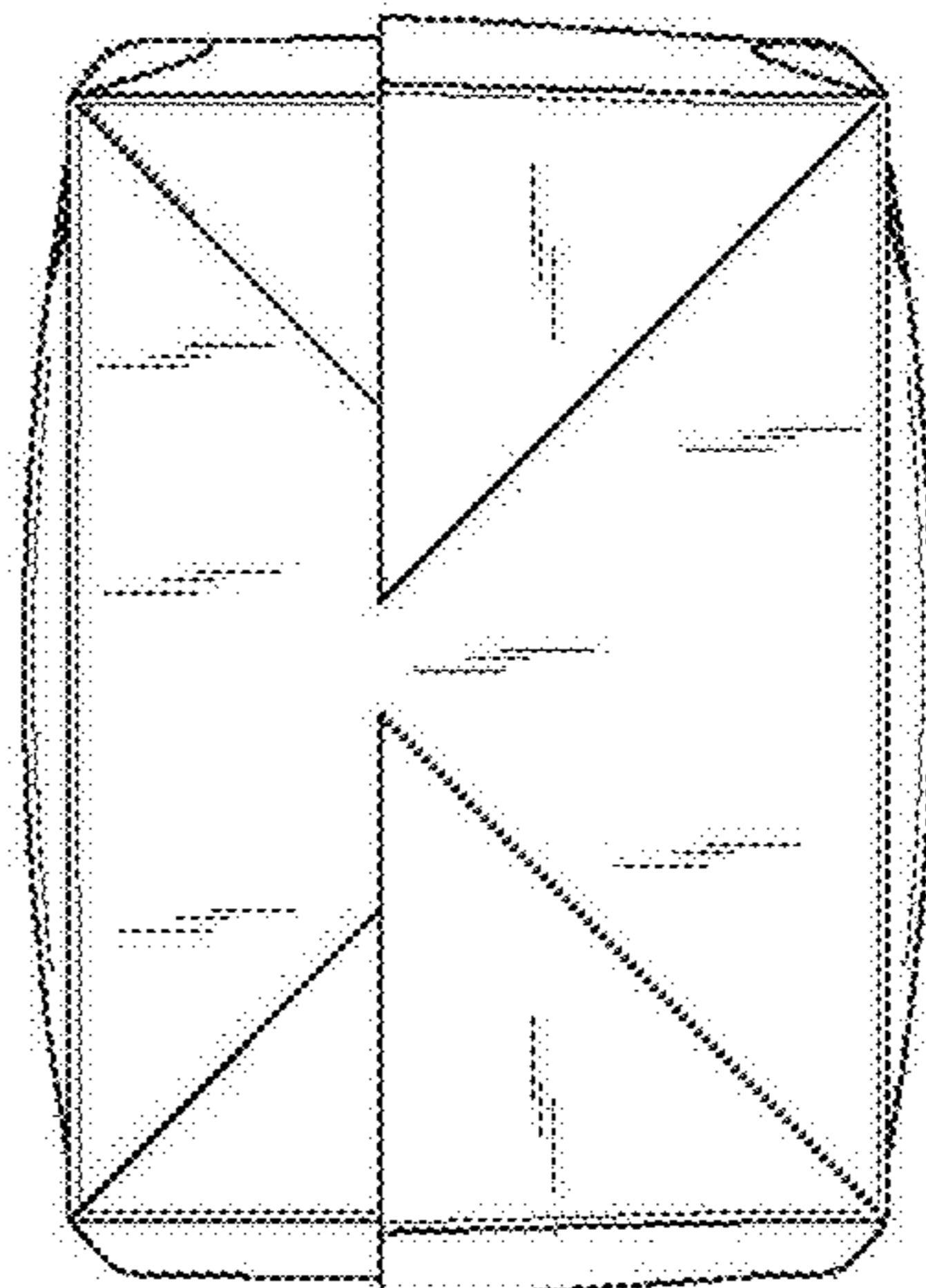

FIG. 13

