



US00D764275S

(12) **United States Design Patent**  
**Joergensen et al.**

(10) **Patent No.:** **US D764,275 S**  
(45) **Date of Patent:** **\*\* Aug. 23, 2016**

(54) **FOOD CONTAINER**

(71) Applicant: **NatureSweet, Ltd.**, San Antonio, TX  
(US)

(72) Inventors: **J. Michael Joergensen**, San Antonio,  
TX (US); **Bryant P. Ambelang**, San  
Antonio, TX (US); **Jacob Teitelbaum**,  
Oakland, CA (US)

(73) Assignee: **NatureSweet, Ltd.**, San Antonio, TX  
(US)

(\*\*) Term: **14 Years**

(21) Appl. No.: **29/511,263**

(22) Filed: **Dec. 9, 2014**

(51) **LOC (10) Cl.** ..... **09-03**

(52) **U.S. Cl.**  
USPC ..... **D9/425**

(58) **Field of Classification Search**  
USPC ..... D9/414, 418, 420, 423, 424, 425, 427,  
D9/430, 431, 432, 643-647, 715, 717, 721,  
D9/737, 756, 757, 762, 761; D7/541,  
D7/553.1, 601, 602, 629, 630, 701, 703,  
D7/707, 708; 220/4.21-4.22, 602-60, 669,  
220/675, 835-839, 602-609  
CPC .... B65D 85/34; B65D 85/345; B65D 43/161;  
B65D 43/162  
See application file for complete search history.

(56) **References Cited**

**U.S. PATENT DOCUMENTS**

- 5,131,551 A \* 7/1992 Wells ..... B65D 43/162  
206/518
- D376,314 S \* 12/1996 Krupa ..... D9/425
- D569,242 S \* 5/2008 Flamand ..... D9/420
- D587,109 S \* 2/2009 Lyon ..... D9/737
- D611,304 S \* 3/2010 DeLeo ..... D7/538
- D626,014 S \* 10/2010 Fosse ..... D9/757
- D637,482 S \* 5/2011 Snedden ..... D9/425
- D637,483 S \* 5/2011 Snedden ..... D9/425

- D661,943 S \* 6/2012 Pallotto ..... D7/354
- D668,537 S \* 10/2012 Sanfilippo ..... D9/423
- D685,273 S \* 7/2013 Bodmer ..... D9/757

(Continued)

**OTHER PUBLICATIONS**

Trademark/Service Mark Amendment to Allege Use, U.S. Serial No.  
85815523 to NatureSweet, Ltd., mail date Oct. 28, 2013, 10 pages,  
Available at: [http://tsdr.uspto.gov/  
documentviewer?caseId=sn85815523  
&docId=AAU20131029151847#docIndex=15&page=1](http://tsdr.uspto.gov/documentviewer?caseId=sn85815523&docId=AAU20131029151847#docIndex=15&page=1).

*Primary Examiner* — Dana L Meyrow

*Assistant Examiner* — Keith Frank

(74) *Attorney, Agent, or Firm* — Norton Rose Fulbright US  
LLP

(57) **CLAIM**

The ornamental design for a food container, as shown and  
described.

**DESCRIPTION**

FIG. 1 is a front perspective view of a food container showing  
our new design;  
FIG. 2 is a front elevation view thereof;  
FIG. 3 is a back elevation view thereof;  
FIG. 4 is a left elevation view thereof;  
FIG. 5 is a right elevation view thereof;  
FIG. 6 is a top plan view thereof; and  
FIG. 7 is a bottom plan view thereof.  
FIG. 8 is a front perspective view of a food container showing  
the second embodiment of our new design;  
FIG. 9 is a front elevation view thereof;  
FIG. 10 is a back elevation view thereof;  
FIG. 11 is a right elevation view thereof;  
FIG. 12 is a left elevation view thereof;  
FIG. 13 is a top plan view thereof; and,  
FIG. 14 is a bottom plan view thereof.  
The broken lines shown in the figures represent unclaimed  
subject matter and form no part of the claimed design.

**1 Claim, 10 Drawing Sheets**

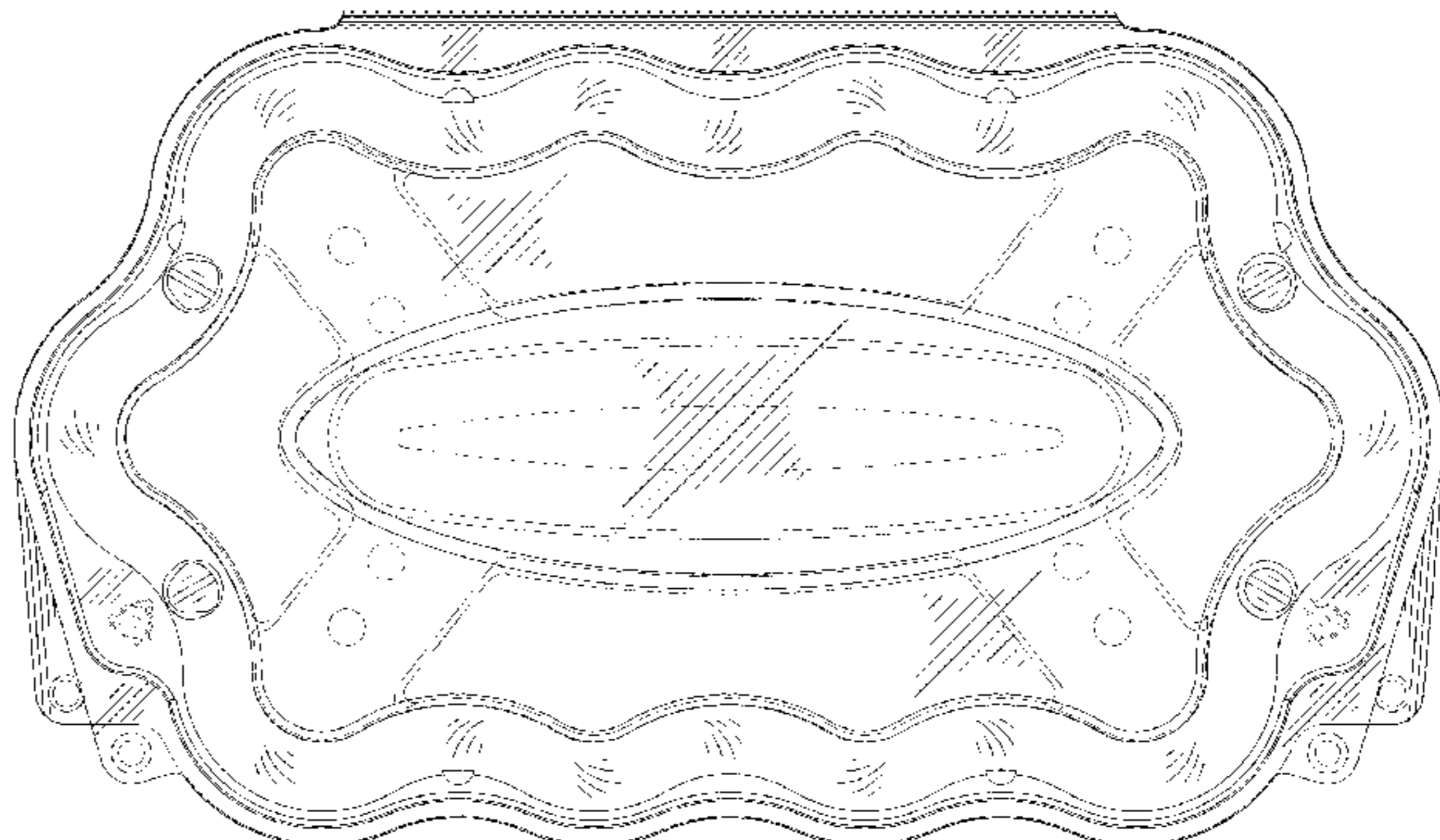
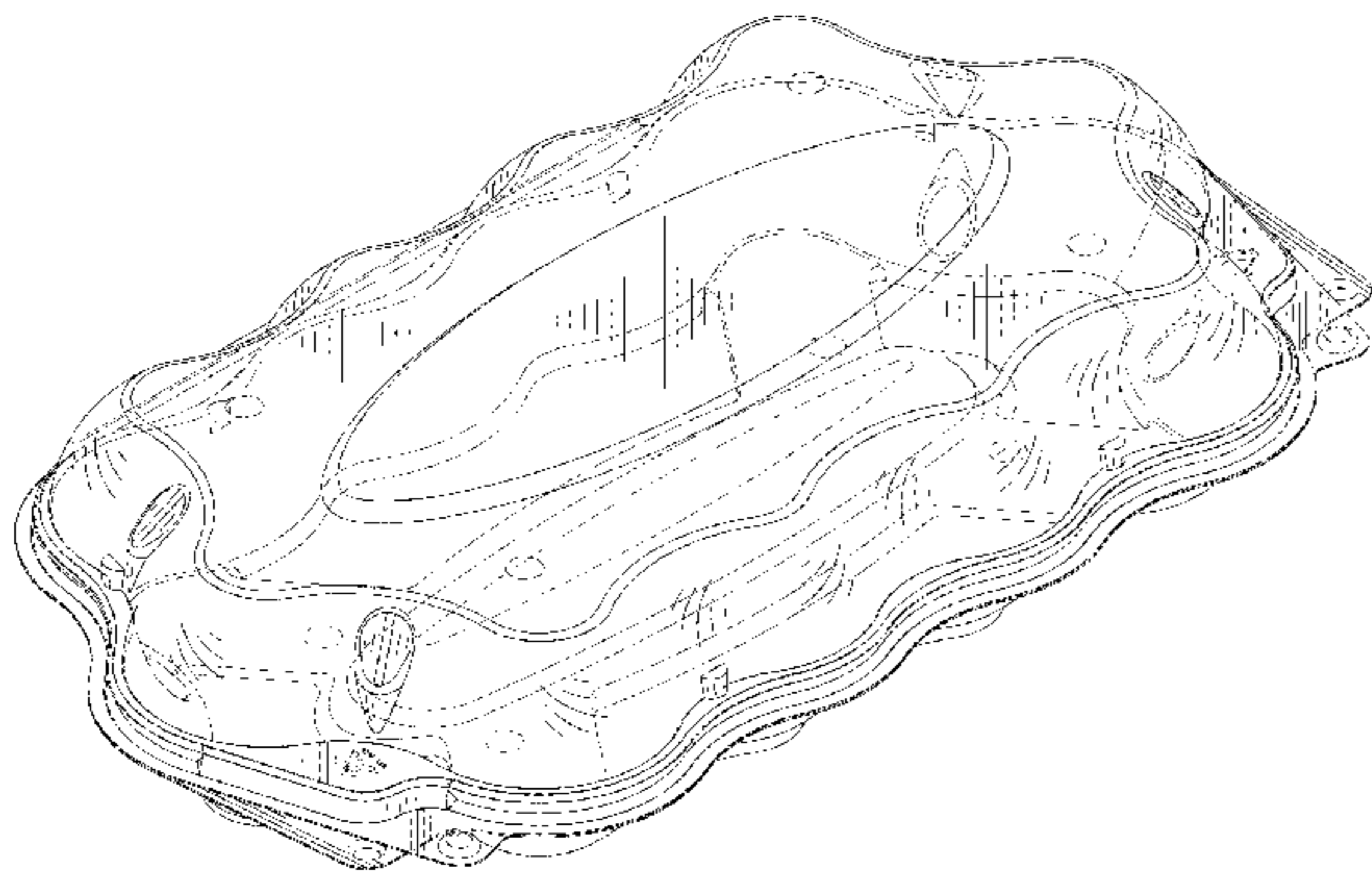

(56)

**References Cited**

U.S. PATENT DOCUMENTS

D687,681 S \* 8/2013 Barber ..... D7/674  
8,545,914 B1 \* 10/2013 Mastroianni ..... B65D 1/36  
206/508  
D695,108 S \* 12/2013 Pham ..... D9/426  
D739,265 S \* 9/2015 Buckley ..... D9/762  
D745,312 S \* 12/2015 Lovgren ..... D7/354

2004/0007583 A1\* 1/2004 Lin ..... B65D 43/162  
D43/162  
2011/0094918 A1\* 4/2011 Hernandez ..... B65D 21/0223  
206/521.15  
2011/0139785 A1\* 6/2011 Strange ..... B65D 43/162  
220/283  
2011/0180446 A1\* 7/2011 Kidd ..... B65D 21/0223  
206/509

\* cited by examiner

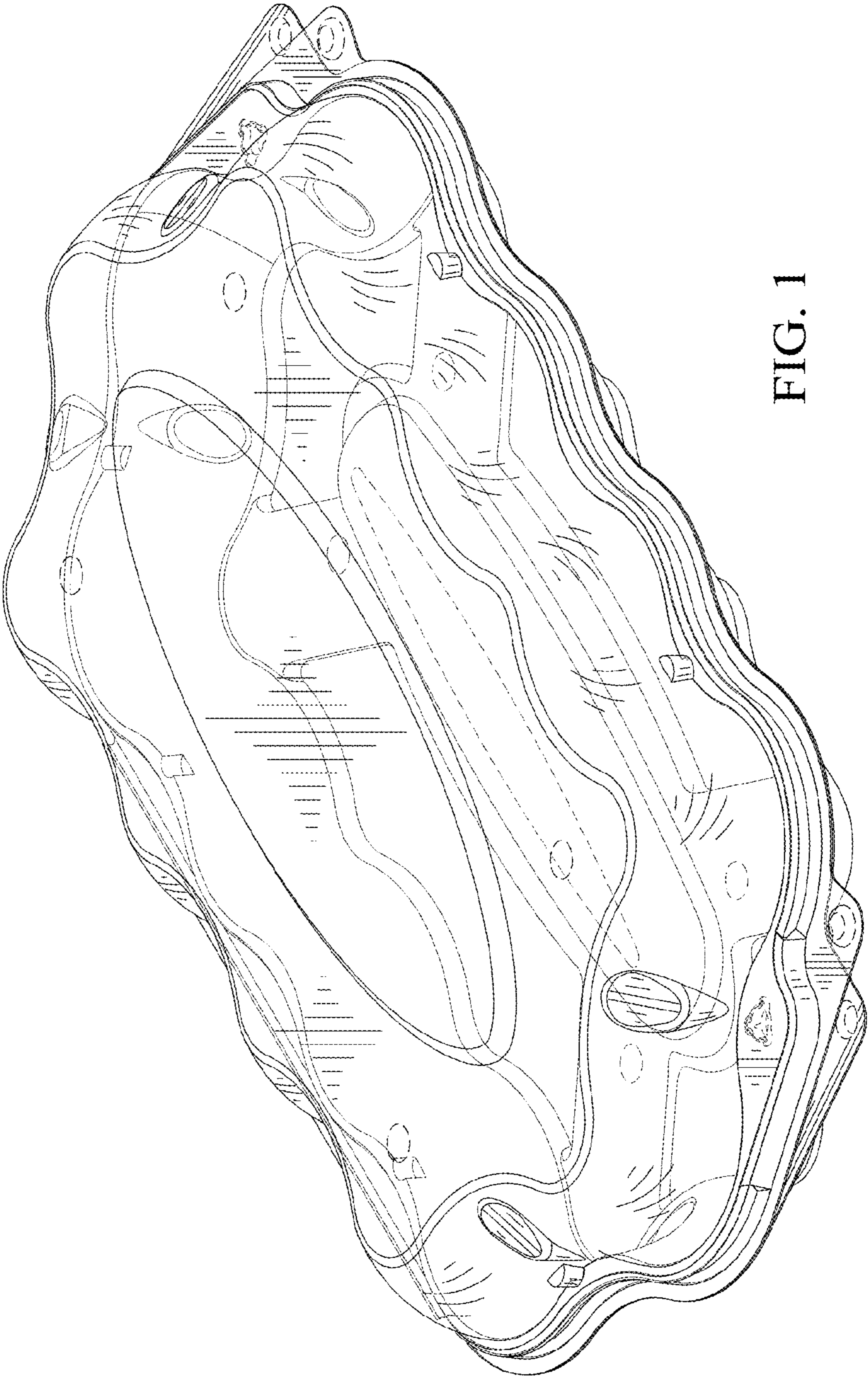

FIG. 1

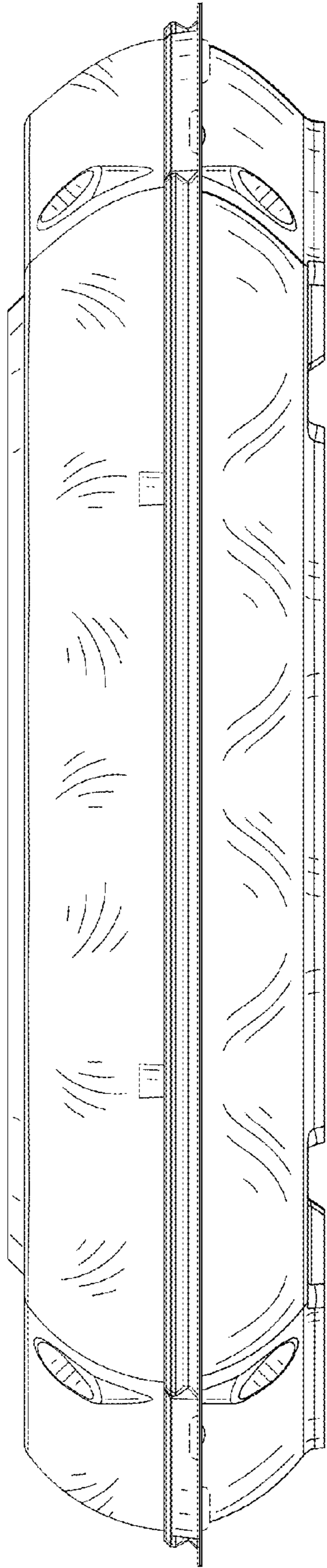

FIG. 2

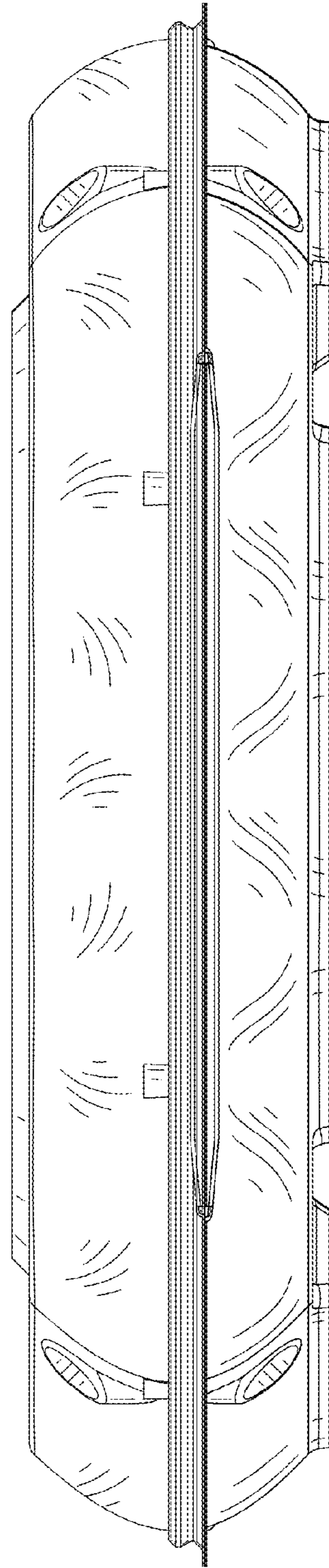

FIG. 3

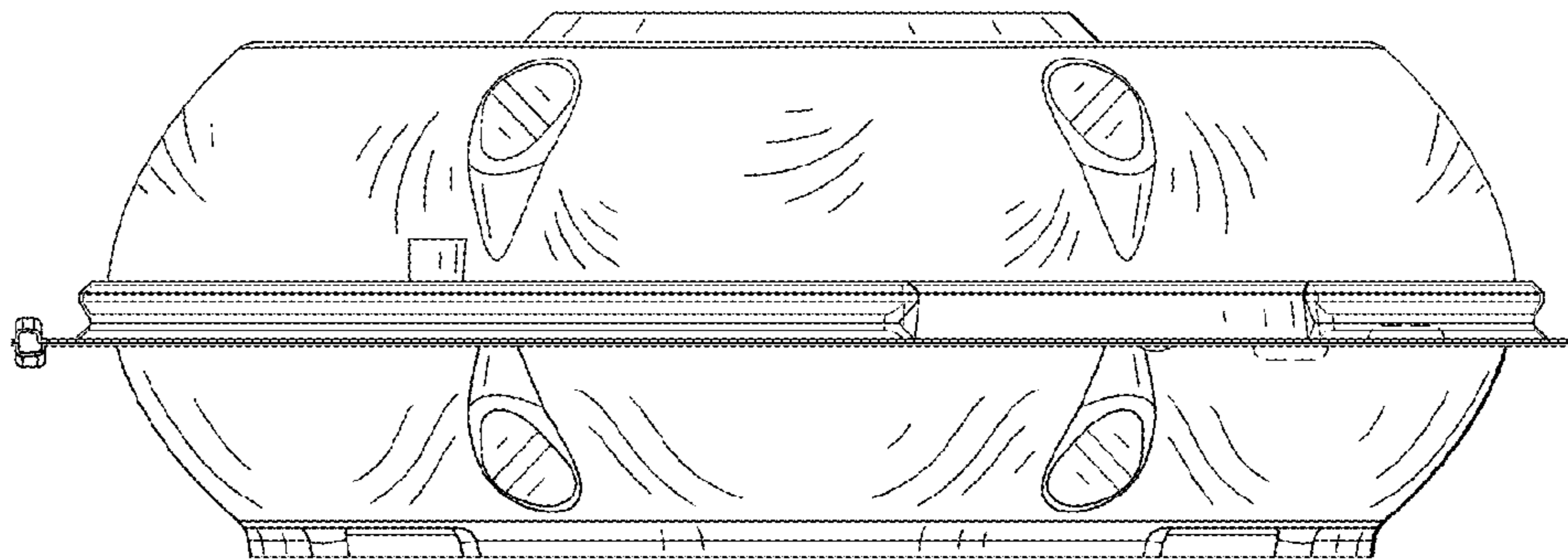

FIG. 4

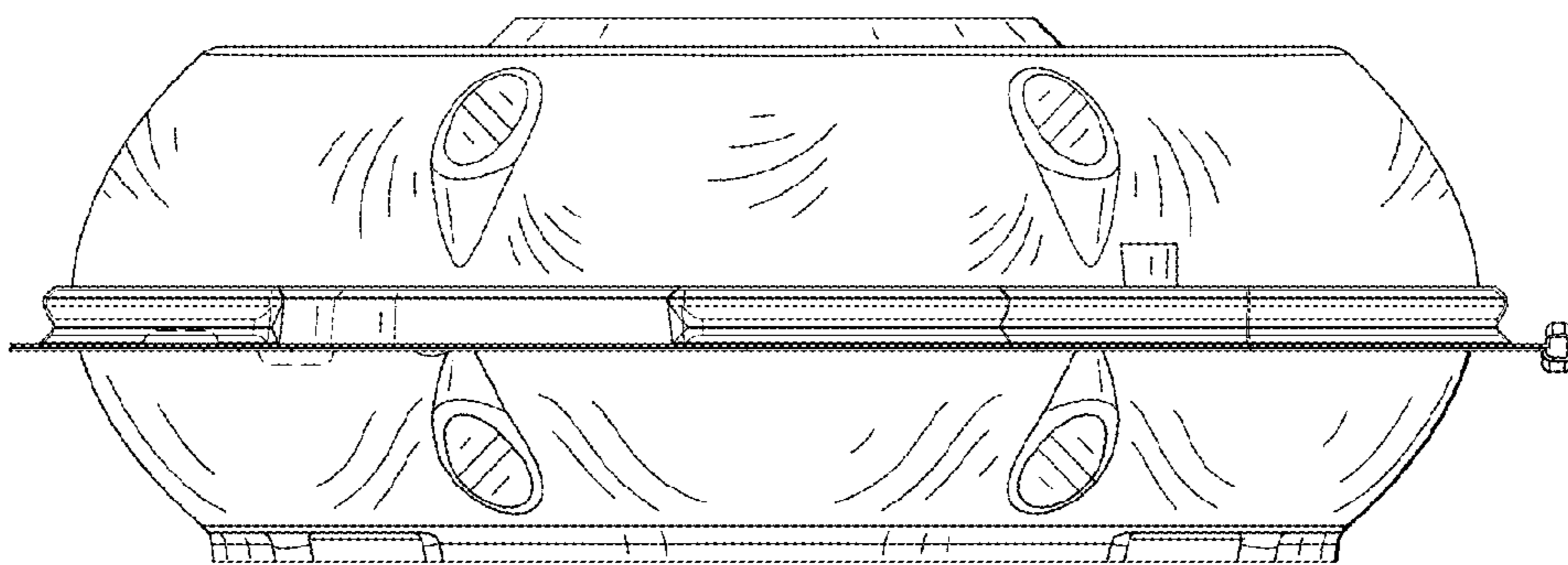

FIG. 5

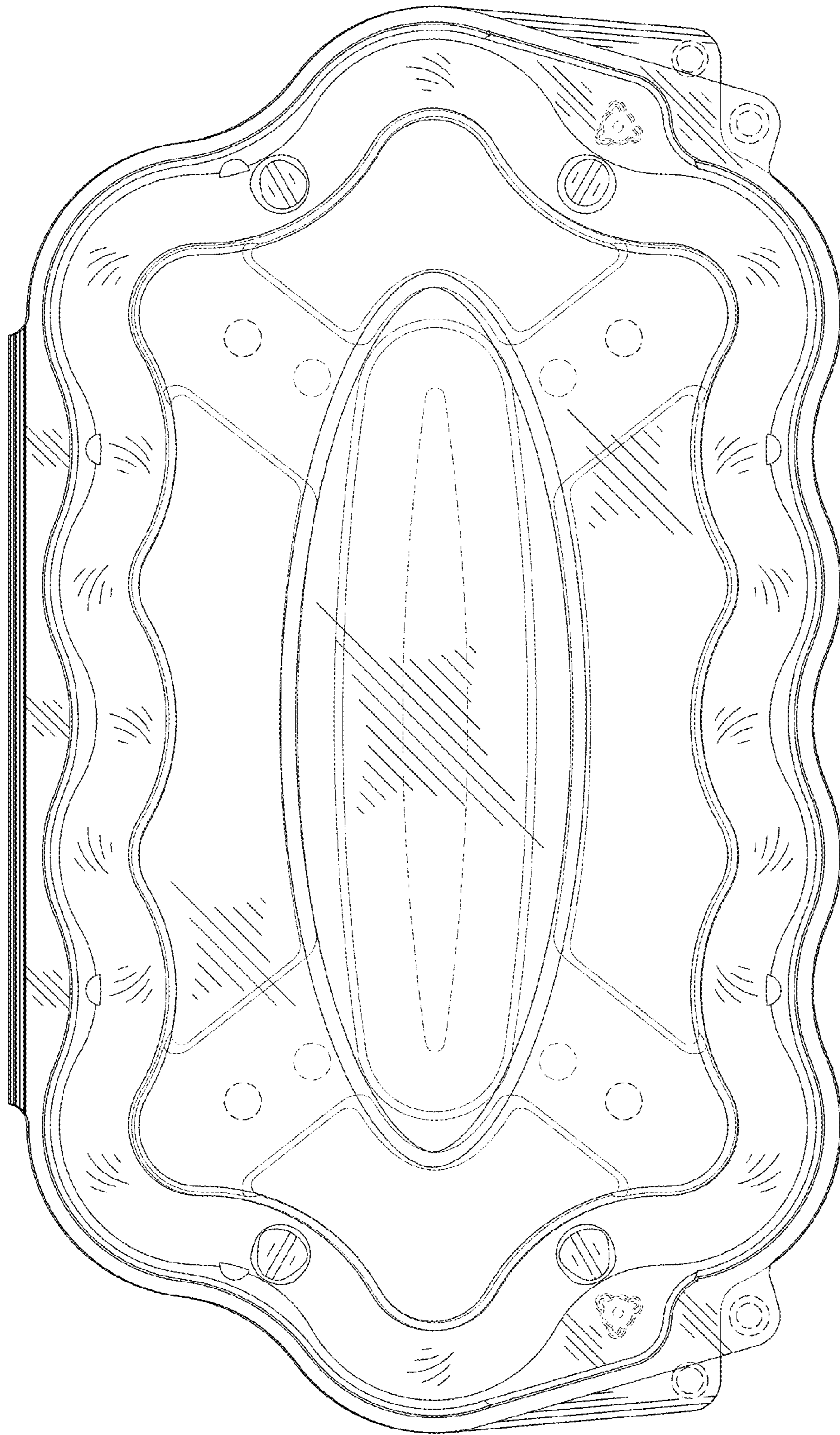

FIG. 6

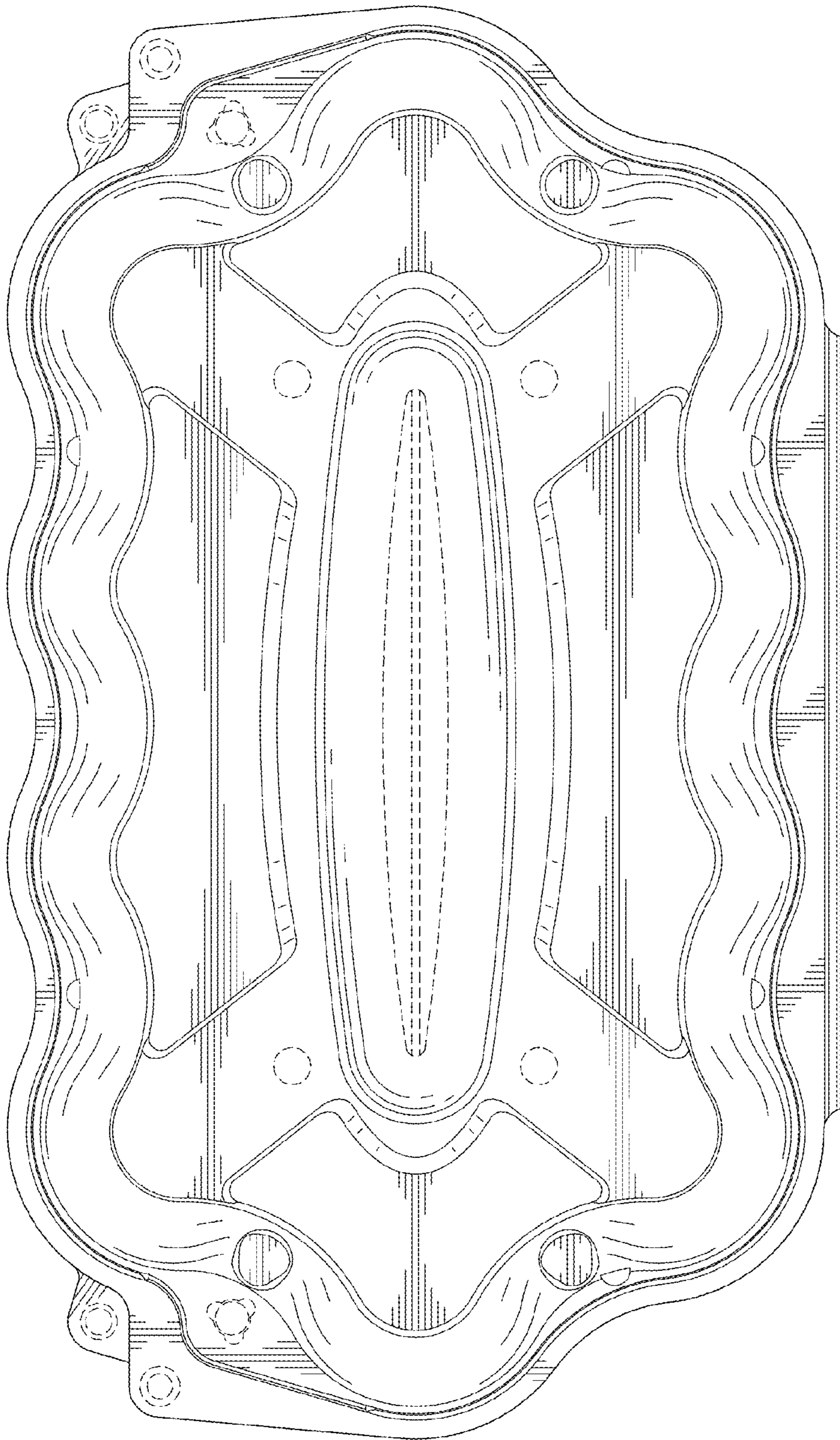

FIG. 7

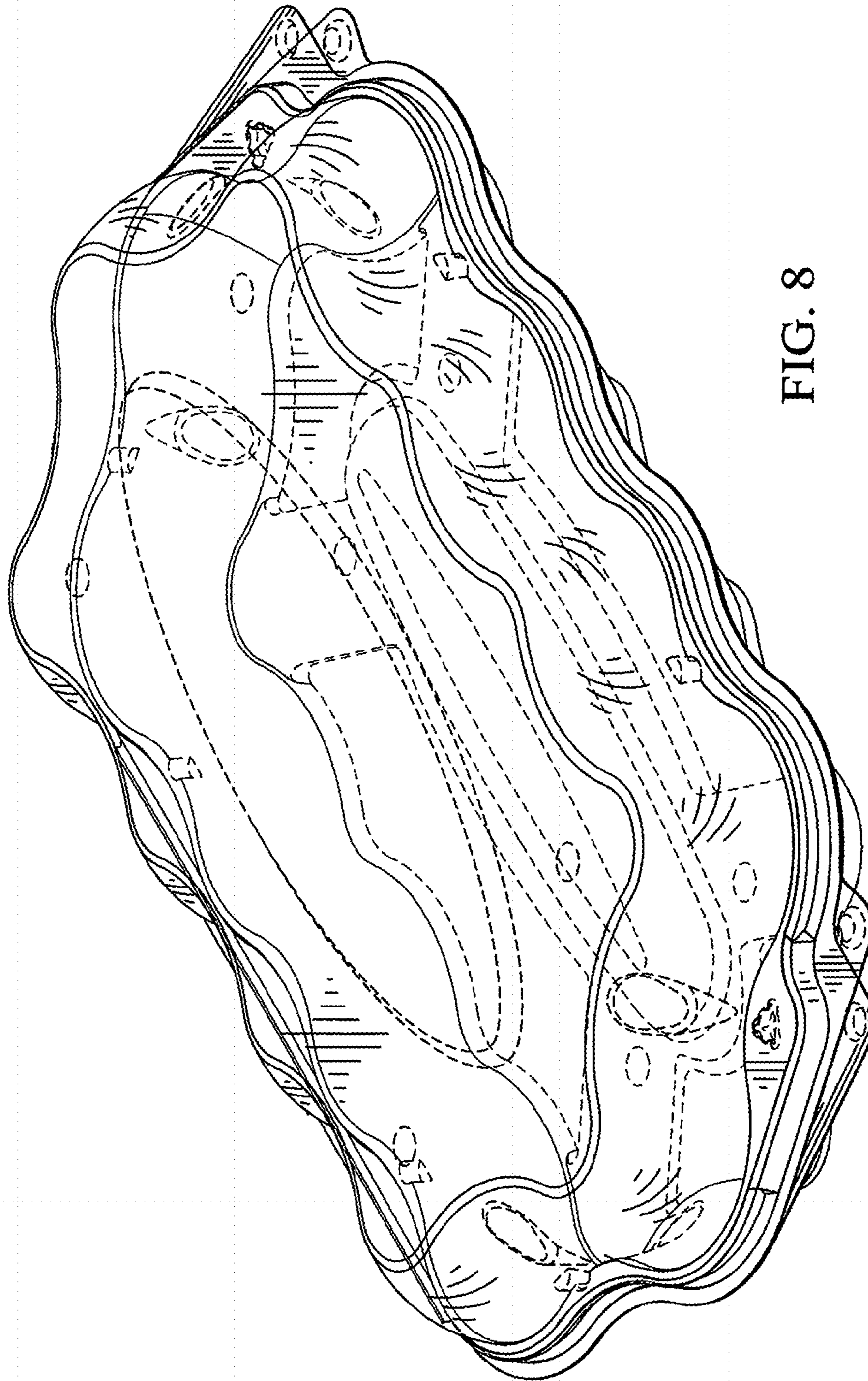

FIG. 8



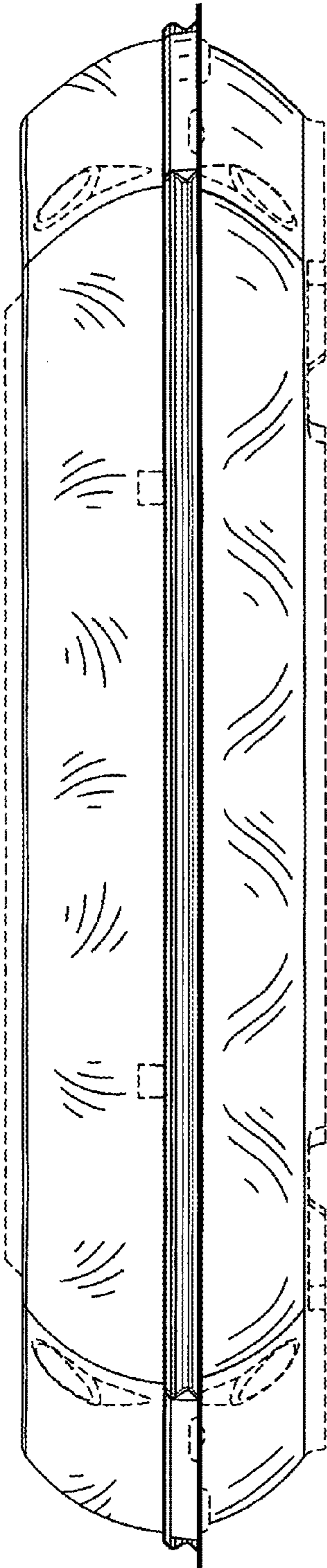

FIG. 9

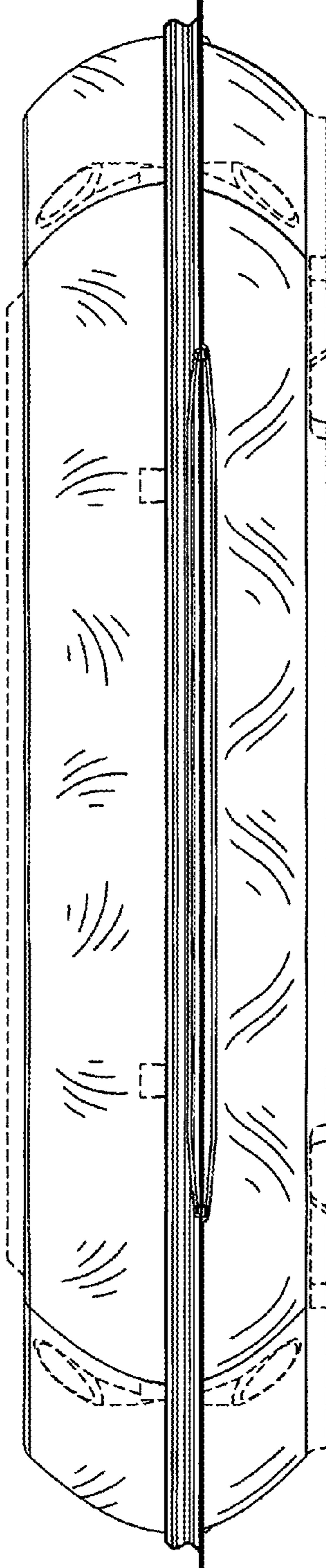

FIG. 10

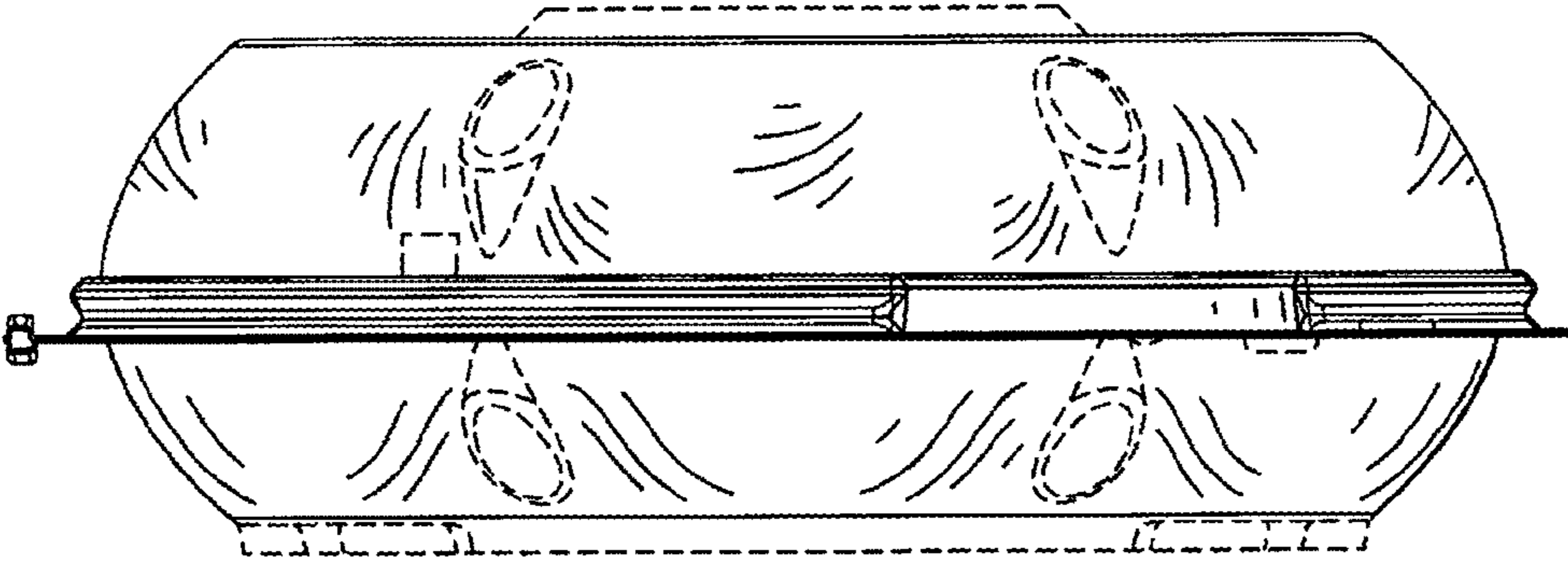

FIG. 11

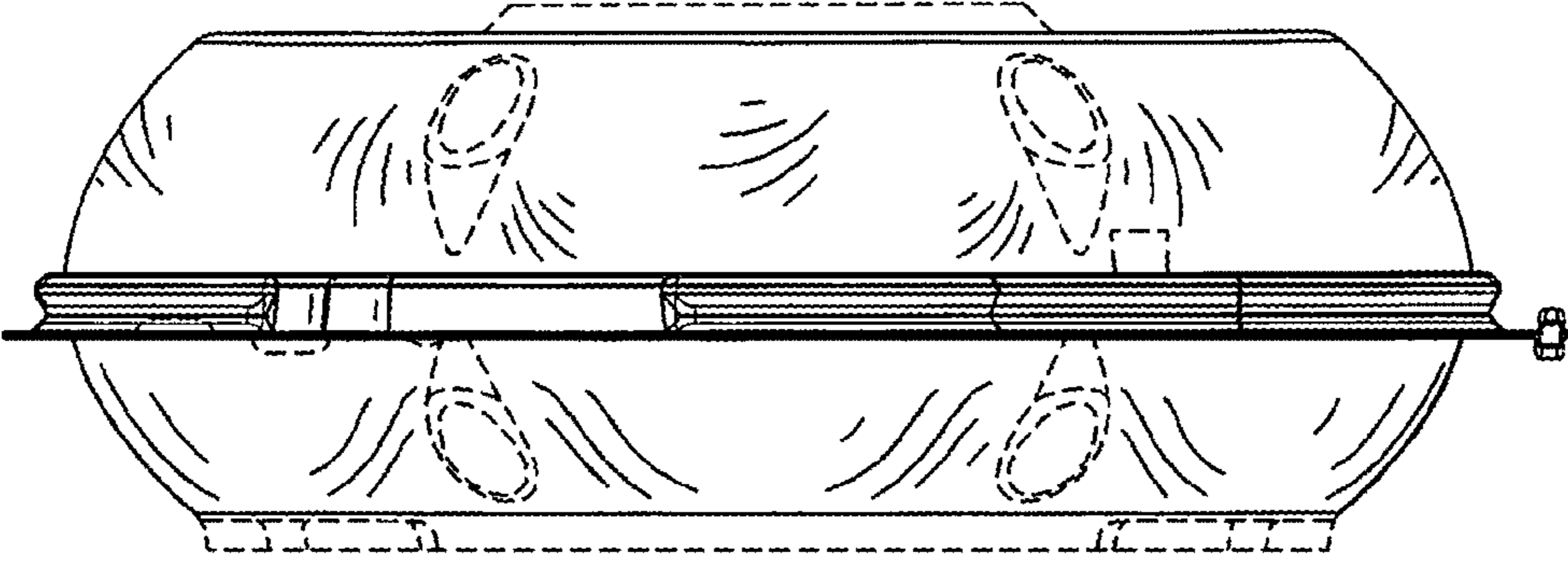

FIG. 12

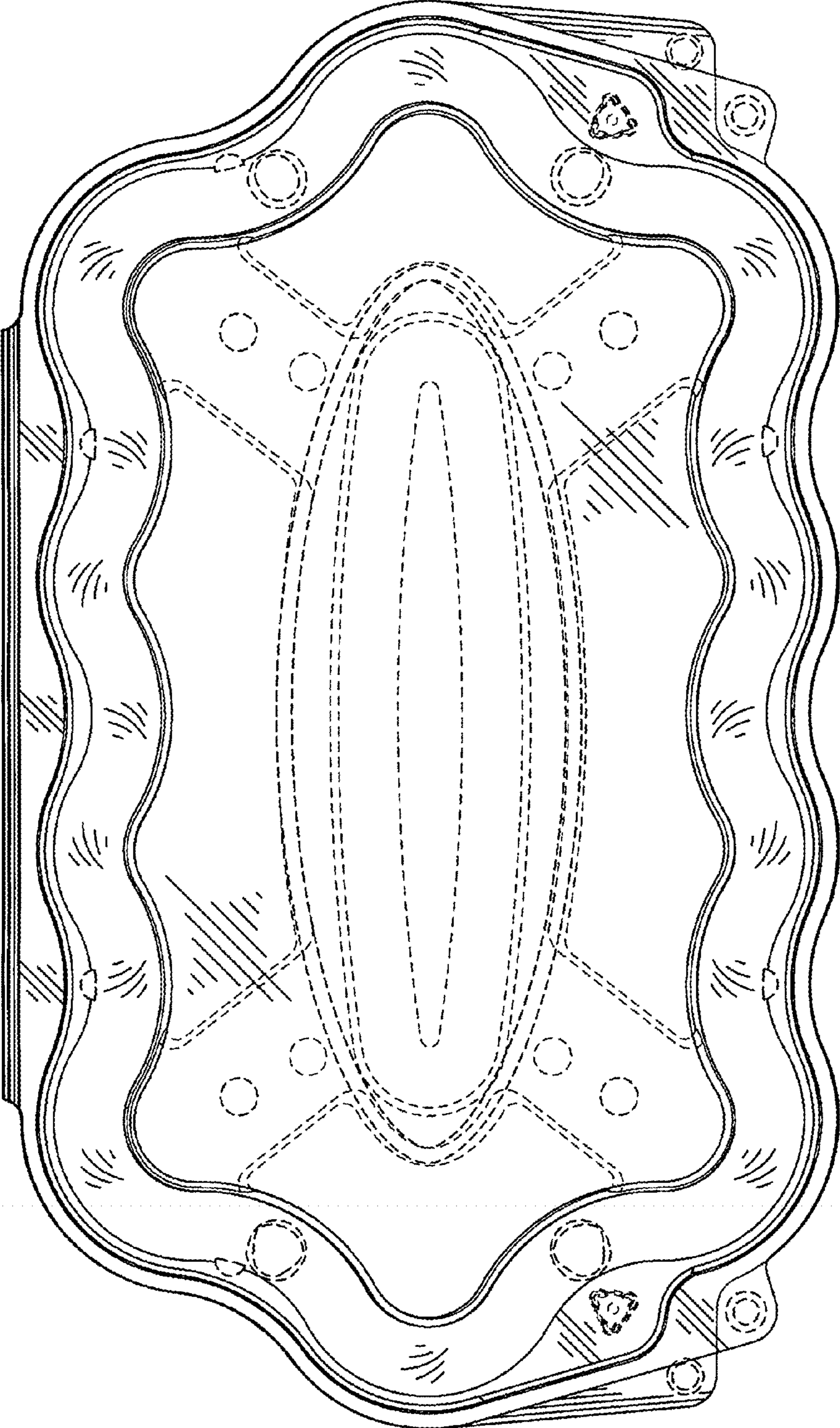

FIG. 13

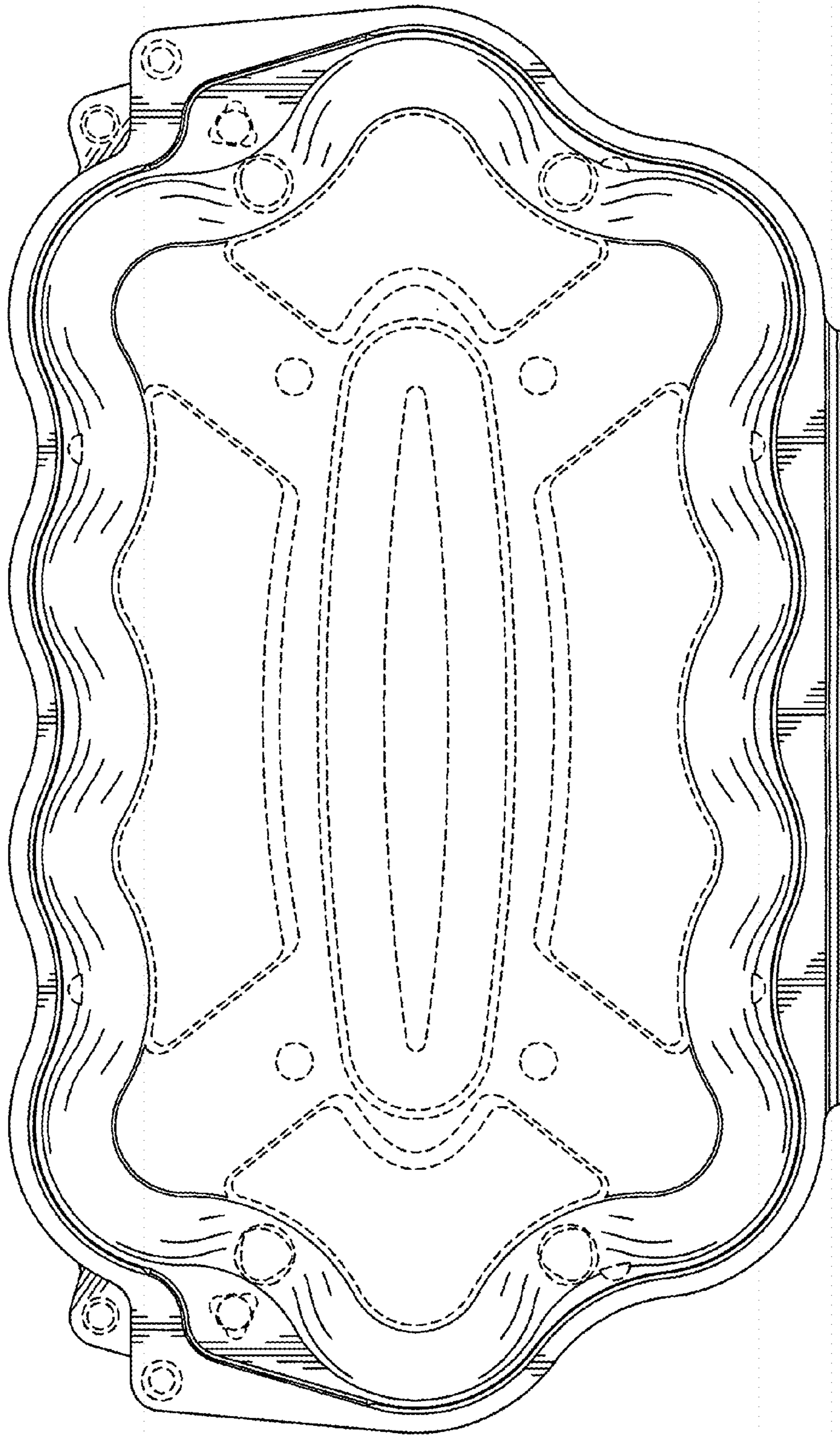

FIG. 14

UNITED STATES PATENT AND TRADEMARK OFFICE  
**CERTIFICATE OF CORRECTION**

PATENT NO. : D764,275 S  
APPLICATION NO. : 29/511263  
DATED : August 23, 2016  
INVENTOR(S) : J. Michael Joergensen et al.

Page 1 of 7

It is certified that error appears in the above-identified patent and that said Letters Patent is hereby corrected as shown below:

On the Title Page

Delete Title Page and replace with attached Title Page.

In the Drawings

Delete Drawing Sheets 1-10 and Replace with attached Drawing Sheets 1-5.

Signed and Sealed this  
Second Day of January, 2018



Joseph Matal  
*Performing the Functions and Duties of the  
Under Secretary of Commerce for Intellectual Property and  
Director of the United States Patent and Trademark Office*

(12) **United States Design Patent**  
**Joergensen et al.**

(10) **Patent No.:** **US D764,275 S**  
(45) **Date of Patent:** **\*\* Aug. 23, 2016**

(54) **FOOD CONTAINER**  
(71) Applicant: **NatureSweet, Ltd.**, San Antonio, TX (US)  
(72) Inventors: **J. Michael Joergensen**, San Antonio, TX (US); **Bryant P. Ambelang**, San Antonio, TX (US); **Jacob Teitelbaum**, Oakland, CA (US)  
(73) Assignee: **NatureSweet, Ltd.**, San Antonio, TX (US)  
(\*\*) Term: **14 Years**  
(21) Appl. No.: **29/511,263**  
(22) Filed: **Dec. 9, 2014**  
(51) **LOC (10) Cl.** ..... **09-03**  
(52) **U.S. Cl.**  
USPC ..... **D9/425**  
(58) **Field of Classification Search**  
USPC ..... D9/414, 418, 420, 423, 424, 425, 427, D9/430, 431, 432, 643-647, 715, 717, 721, D9/737, 756, 757, 762, 761; D7/541, D7/553.1, 601, 602, 629, 630, 701, 703, D7/707, 708; 220/4.21-4.22, 602-60, 669, 220/675, 835-839, 602-609  
CPC .... B65D 85/34; B65D 85/345; B65D 43/161; B65D 43/162  
See application file for complete search history.

D661,943 S \* 6/2012 Pallotto ..... D7/354  
D668,537 S \* 10/2012 Sanfilippo ..... D9/423  
D685,273 S \* 7/2013 Bodmer ..... D9/757  
(Continued)

**OTHER PUBLICATIONS**

Trademark/Service Mark Amendment to Allege Use, U.S. Serial No. 85815523 to NatureSweet, Ltd., mail date Oct. 28, 2013, 10 pages, Available at: <http://tsdr.uspto.gov/documentviewer?caseId=sn85815523&docId=AAU20131029151847#docIndex=15&page=1>.

*Primary Examiner* — Dana L Meyrow  
*Assistant Examiner* — Keith Frank  
(74) *Attorney, Agent, or Firm* — Norton Rose Fulbright US LLP

(57) **CLAIM**  
The ornamental design for a food container, as shown and described.

**DESCRIPTION**

FIG. 1 is a front perspective view of a food container showing our new design;  
FIG. 2 is a front elevation view thereof;  
FIG. 3 is a back elevation view thereof;  
FIG. 4 is a left elevation view thereof;  
FIG. 5 is a right elevation view thereof;  
FIG. 6 is a top plan view thereof; and  
FIG. 7 is a bottom plan view thereof.  
The broken lines shown in the figures represent unclaimed subject matter and form no part of the claimed design.

(56) **References Cited**  
**U.S. PATENT DOCUMENTS**  
5,131,551 A \* 7/1992 Wells ..... B65D 43/162 206/518  
D376,314 S \* 12/1996 Krupa ..... D9/425  
D569,242 S \* 5/2008 Flamand ..... D9/420  
D587,109 S \* 2/2009 Lyon ..... D9/737  
D611,304 S \* 3/2010 DeLeo ..... D7/538  
D626,014 S \* 10/2010 Fosse ..... D9/757  
D637,482 S \* 5/2011 Snedden ..... D9/425  
D637,483 S \* 5/2011 Snedden ..... D9/425

**1 Claim, 5 Drawing Sheets**

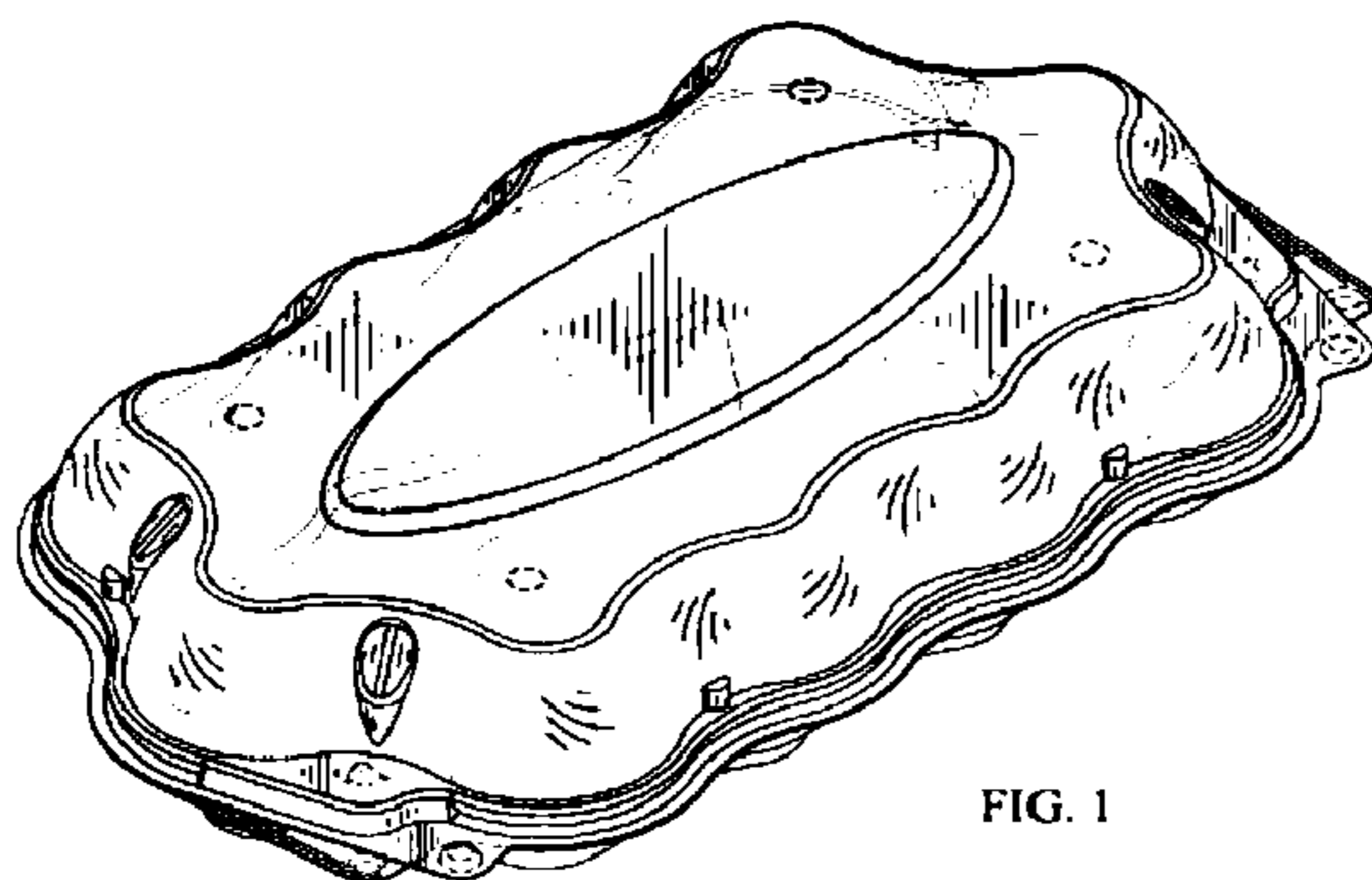
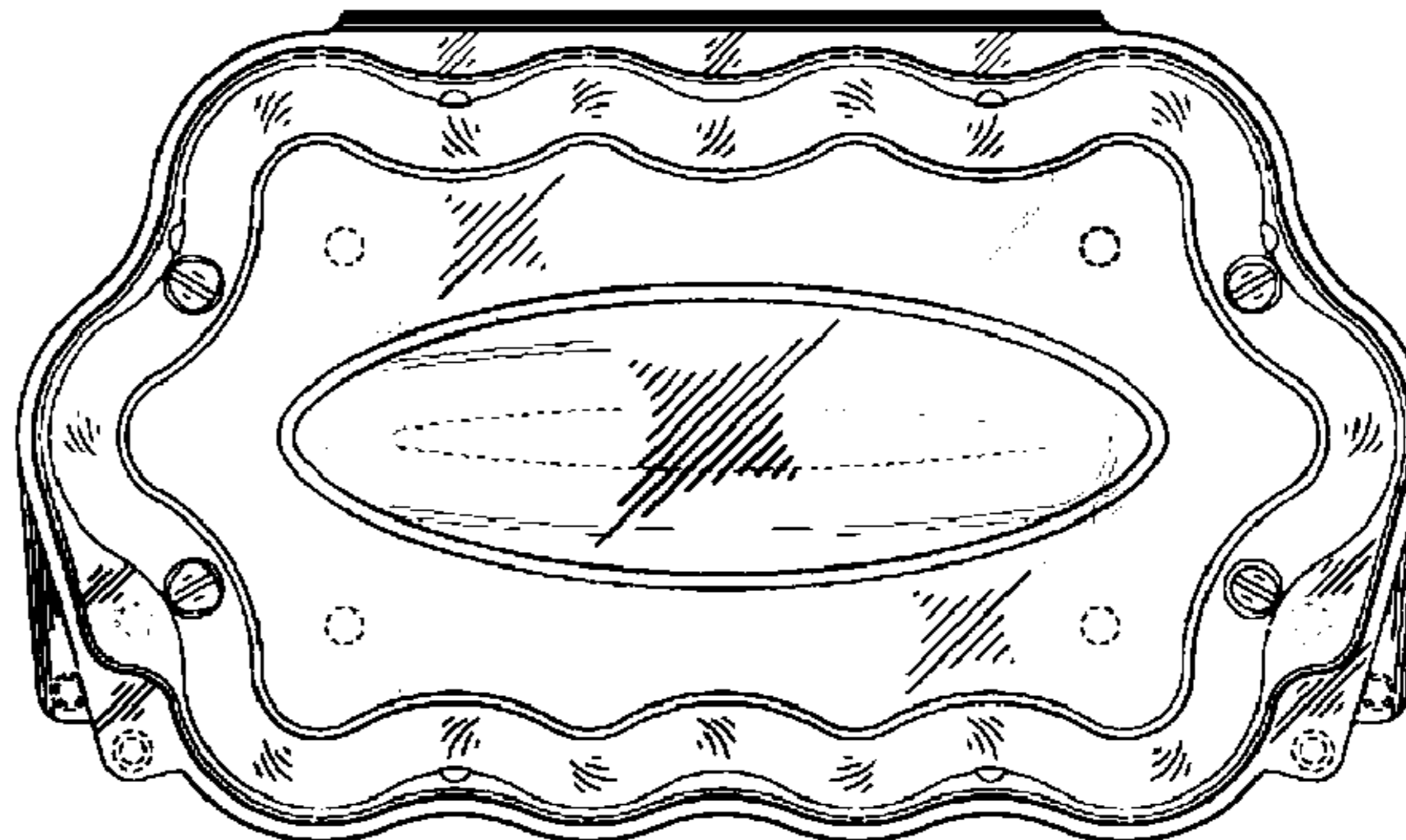

FIG. 1



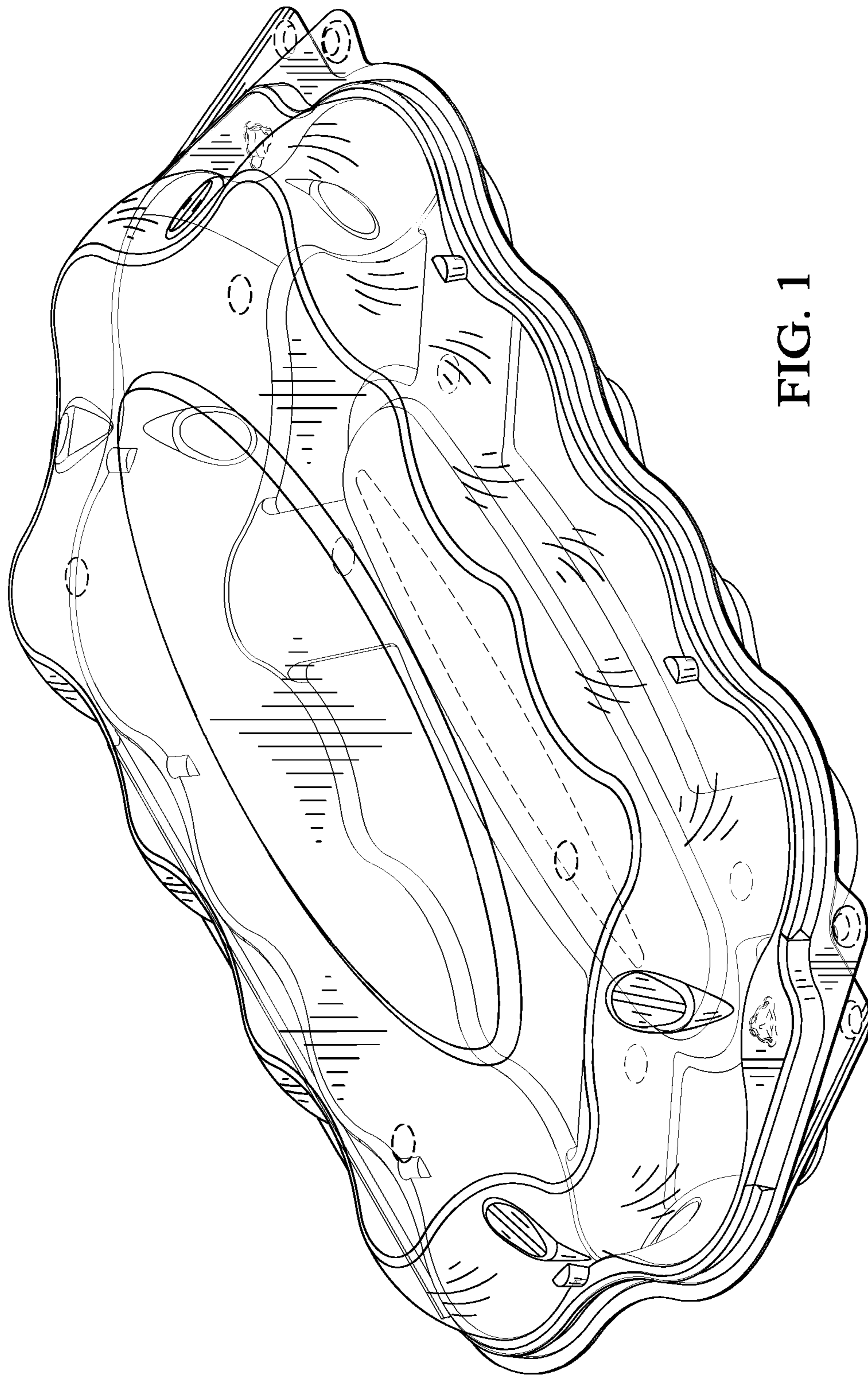

FIG. 1

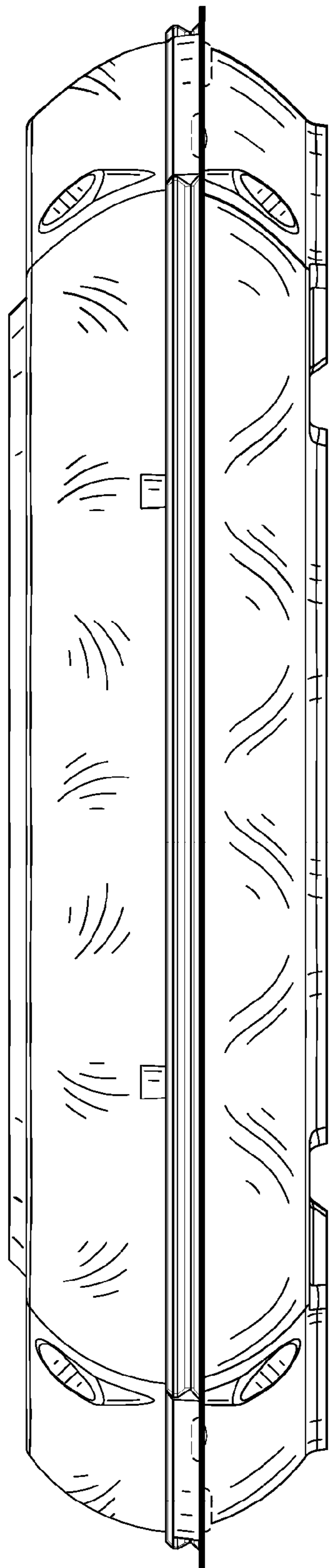

FIG. 2

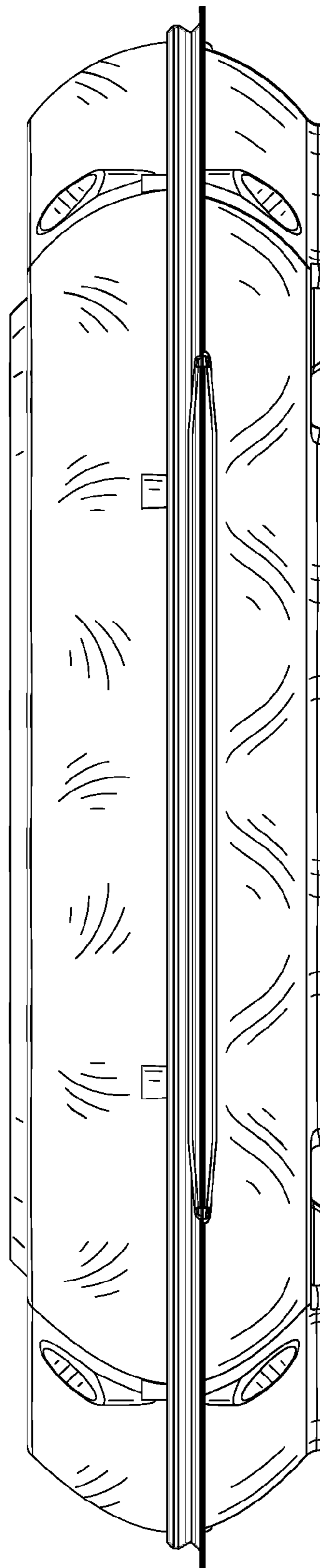

FIG. 3



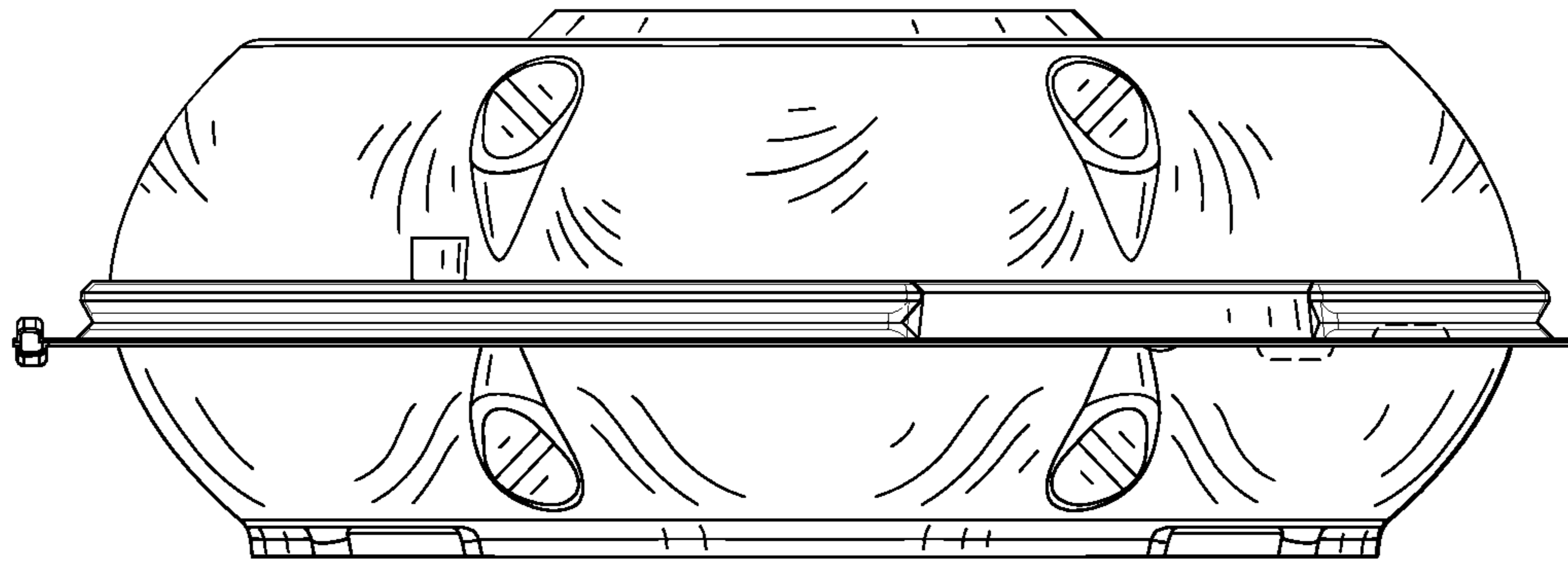

FIG. 4

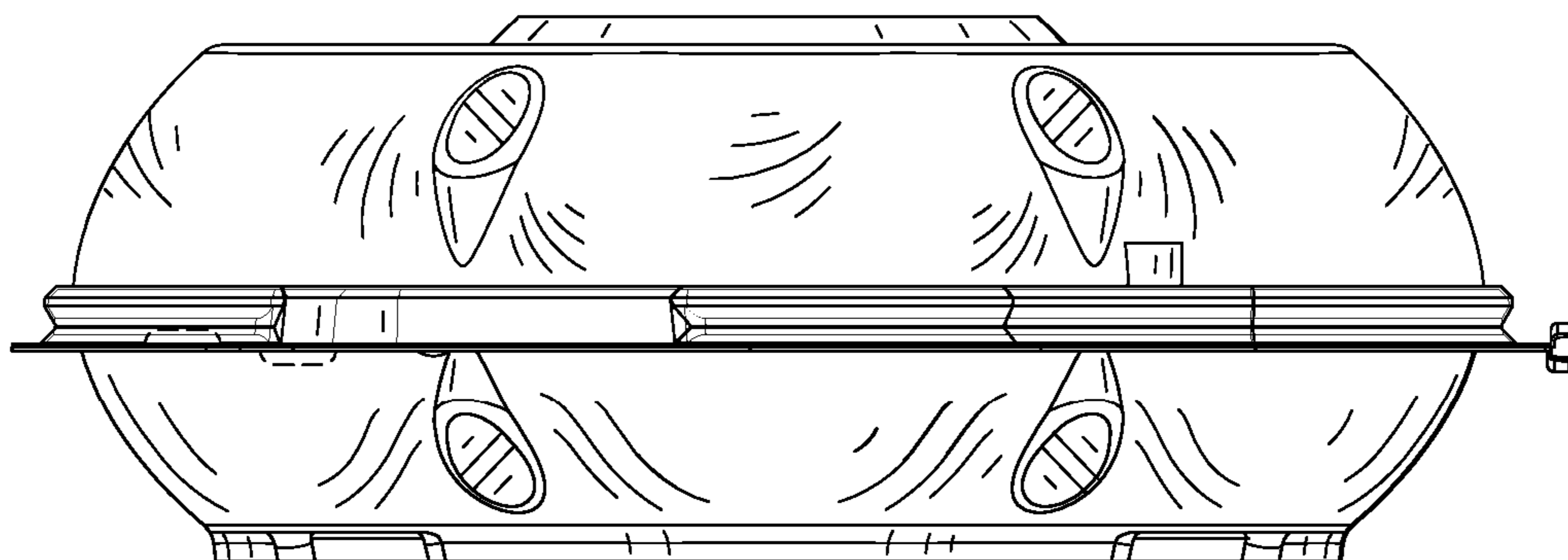

FIG. 5

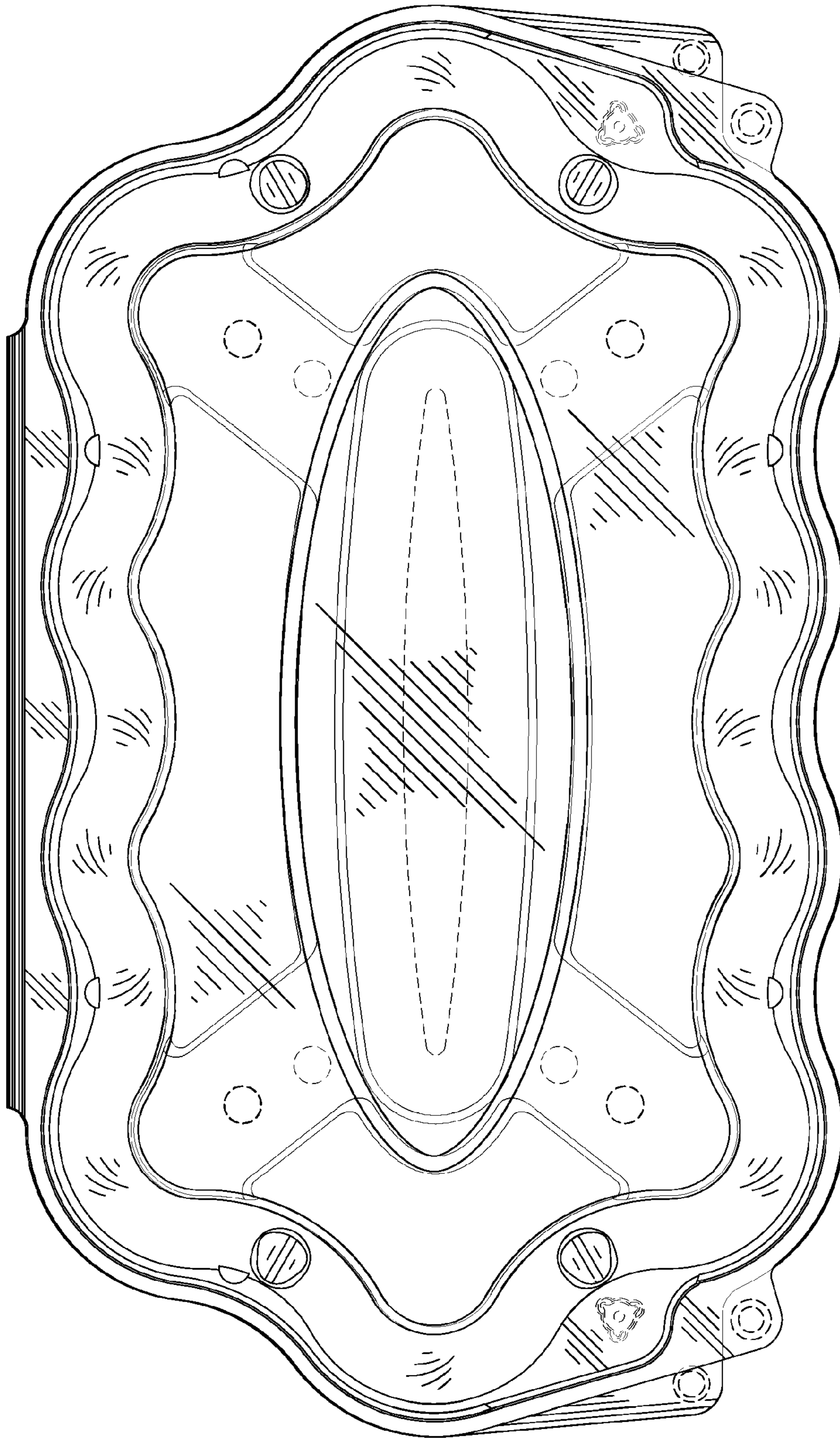

FIG. 6

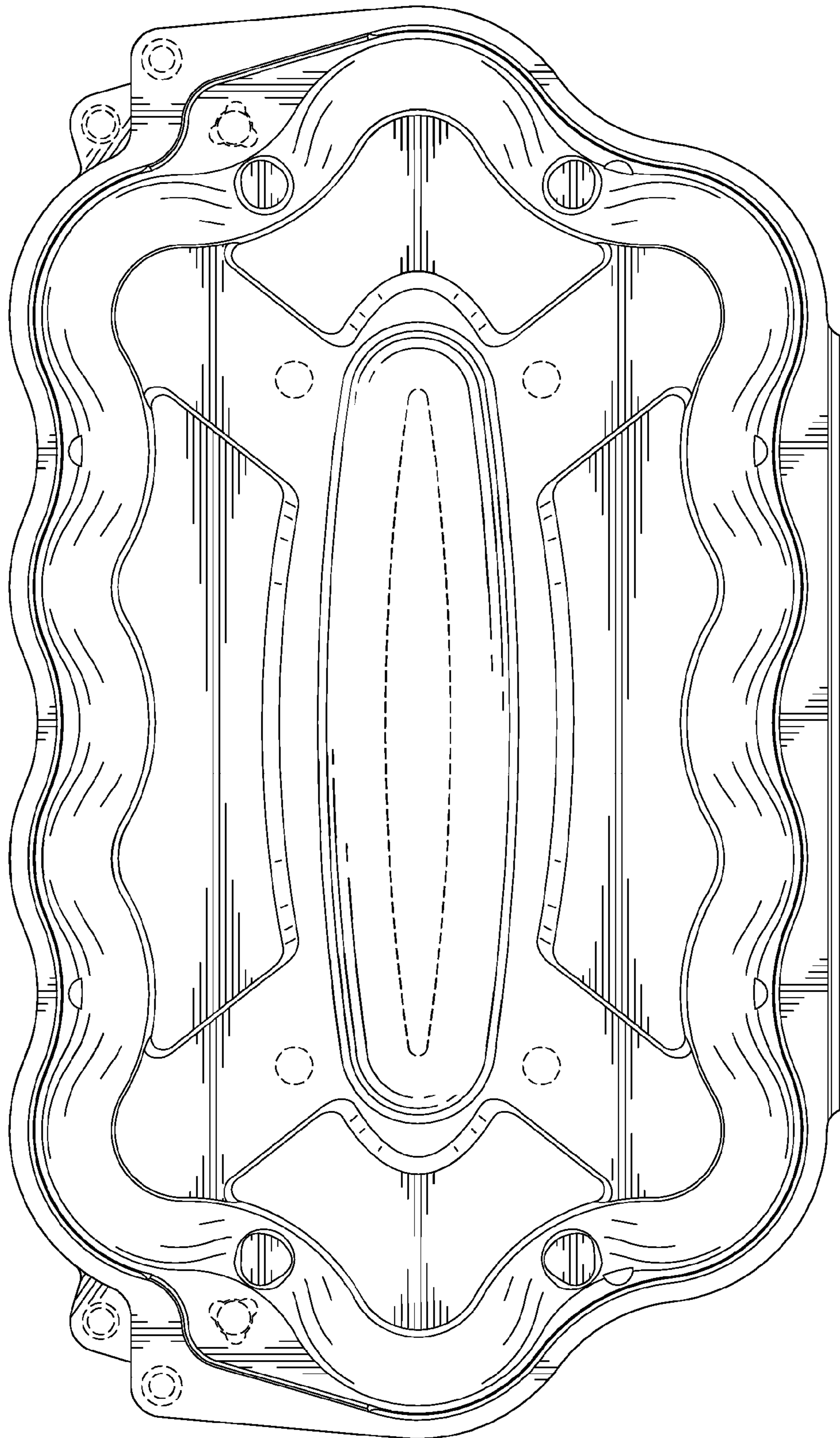

FIG. 7