



US00D764241S

(12) **United States Design Patent**
Lee

(10) **Patent No.:** **US D764,241 S**

(45) **Date of Patent:** **** Aug. 23, 2016**

(54) **JUICER**

(71) Applicant: **HappyCall Co., Ltd.**, Gimhae-si (KR)

(72) Inventor: **Hyun Sam Lee**, Gimhae-si (KR)

(73) Assignee: **HAPPYCALL CO., LTD.** (KR)

(**) Term: **14 Years**

(21) Appl. No.: **29/511,248**

(22) Filed: **Dec. 9, 2014**

(30) **Foreign Application Priority Data**

Jul. 23, 2014 (KR) 30-2014-0036206

(51) **LOC (10) Cl.** **07-04**

(52) **U.S. Cl.**
USPC **D7/665**

(58) **Field of Classification Search**
USPC D7/368, 372-374, 378, 665-667;
241/100; 99/359, 369, 501; 100/208,
100/213
CPC A47J 19/00; A47J 19/02; A47J 19/027;
A47J 44/02; A47J 31/00

See application file for complete search history.

(56) **References Cited**

U.S. PATENT DOCUMENTS

D249,441 S *	9/1978	Fukumoto	D7/665
D290,329 S *	6/1987	Bulto	D7/665
D309,082 S *	7/1990	Hattle	D7/384
D332,899 S *	2/1993	Shun	D7/666
D333,412 S *	2/1993	Levin	D7/665
D333,947 S *	3/1993	Markee	D7/665
D341,522 S *	11/1993	Lamson	D7/665
D343,097 S *	1/1994	Cesari	D7/665
D428,778 S *	8/2000	Kao	D7/666
D439,808 S *	4/2001	McClean	D7/665
D464,535 S *	10/2002	O'Flynn	D7/666
D471,408 S *	3/2003	Fouquet	D7/665

D488,678 S *	4/2004	Berthier	D7/665
D491,423 S *	6/2004	Stamper, III	D7/665
D498,642 S *	11/2004	Huang	D7/378
D501,370 S *	2/2005	Hensel	D7/665
D512,882 S *	12/2005	Hsu	D7/665
D513,943 S *	1/2006	Hsu	D7/665
D521,813 S *	5/2006	Piret	D7/665
D522,321 S *	6/2006	Hsu	D7/665
D528,873 S *	9/2006	Hensel	D7/665
D537,303 S *	2/2007	Stuckey	D7/378
D538,115 S *	3/2007	Lin	D7/665
D538,116 S *	3/2007	Siu	D7/665
D601,391 S *	10/2009	Chiang	D7/665
D618,049 S *	6/2010	Wu	D7/376
D623,908 S *	9/2010	Wu	D7/665
D637,863 S *	5/2011	Wu	D7/376
D637,864 S *	5/2011	Wu	D7/376
D638,256 S *	5/2011	Wu	D7/376
D638,665 S *	5/2011	Wu	D7/378
D641,214 S *	7/2011	Choi	D7/665
D643,265 S *	8/2011	Kim	D7/665
D660,660 S *	5/2012	Kim	D7/666
D665,632 S *	8/2012	Kim	D7/665

(Continued)

Primary Examiner — Rosemary K Tarcza

Assistant Examiner — James Thorn, Sr.

(74) *Attorney, Agent, or Firm* — Cantor Colburn LLP

(57) **CLAIM**

The ornamental design for a juicer, as shown and described.

DESCRIPTION

FIG. 1 is a perspective view of a juicer showing my new design;

FIG. 2 is a front elevational view thereof;

FIG. 3 is a rear elevational view thereof;

FIG. 4 is a left side elevational view thereof;

FIG. 5 is a right side elevational view thereof;

FIG. 6 is a top plan view thereof; and,

FIG. 7 is a bottom plan view thereof.

The broken lines are included for illustrative purposes only and form no part of the claimed design.

1 Claim, 7 Drawing Sheets

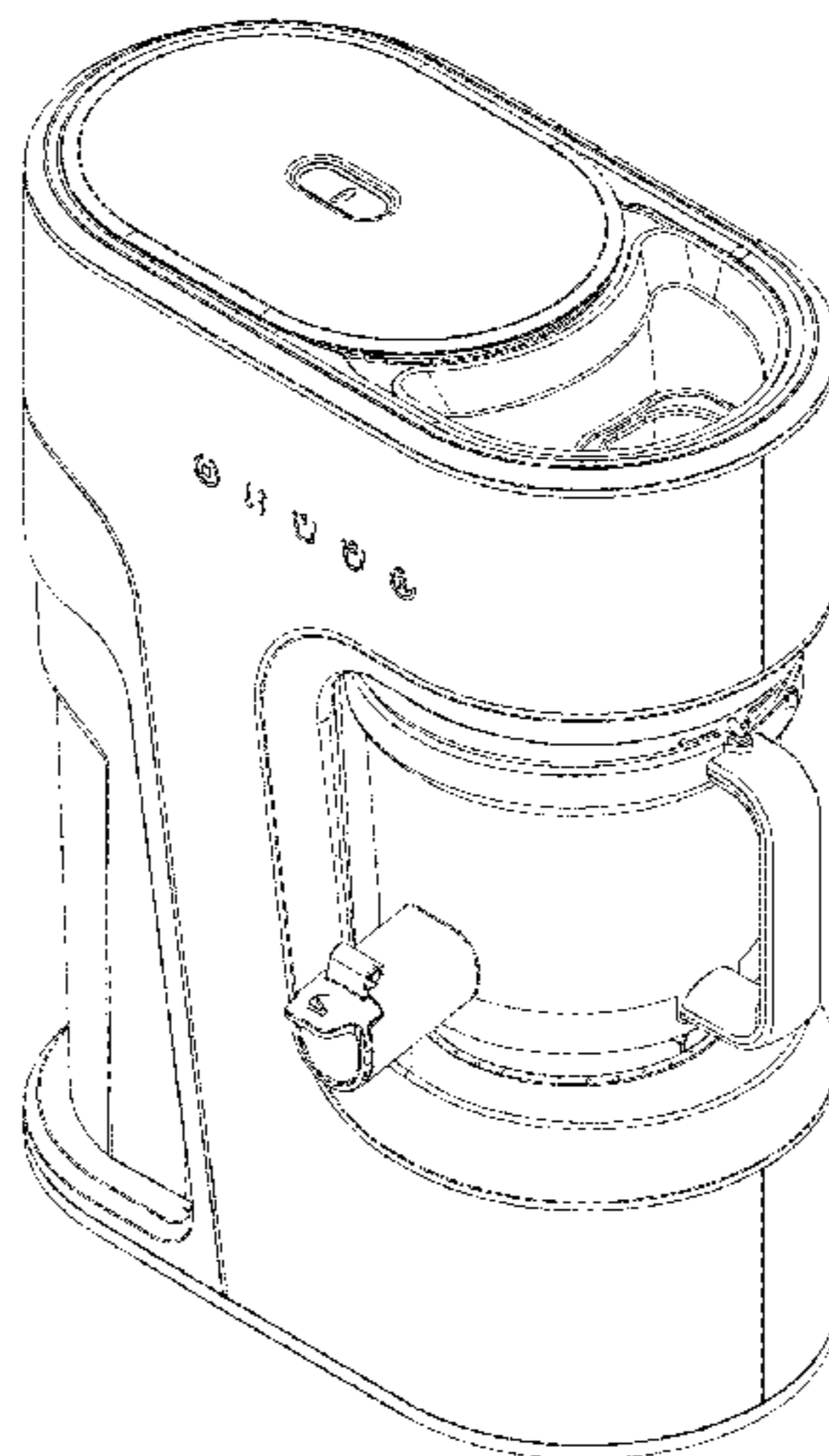

(56)

References Cited

U.S. PATENT DOCUMENTS

D682,629 S * 5/2013 Bachmann D7/665
D700,477 S * 3/2014 Kim D7/412
D710,659 S * 8/2014 Marquez D7/665
D716,615 S * 11/2014 Grossman D7/665
D717,613 S * 11/2014 Wong D7/666

D718,094 S * 11/2014 Yan D7/665
D721,549 S * 1/2015 Li D7/666
D733,504 S * 7/2015 Choi D7/665
D733,505 S * 7/2015 Choi D7/665
D739,686 S * 9/2015 Benoit D7/665
D740,080 S * 10/2015 Shao D7/665
D741,119 S * 10/2015 Wong D7/665
D742,183 S * 11/2015 Kim D7/665

* cited by examiner

FIG. 1

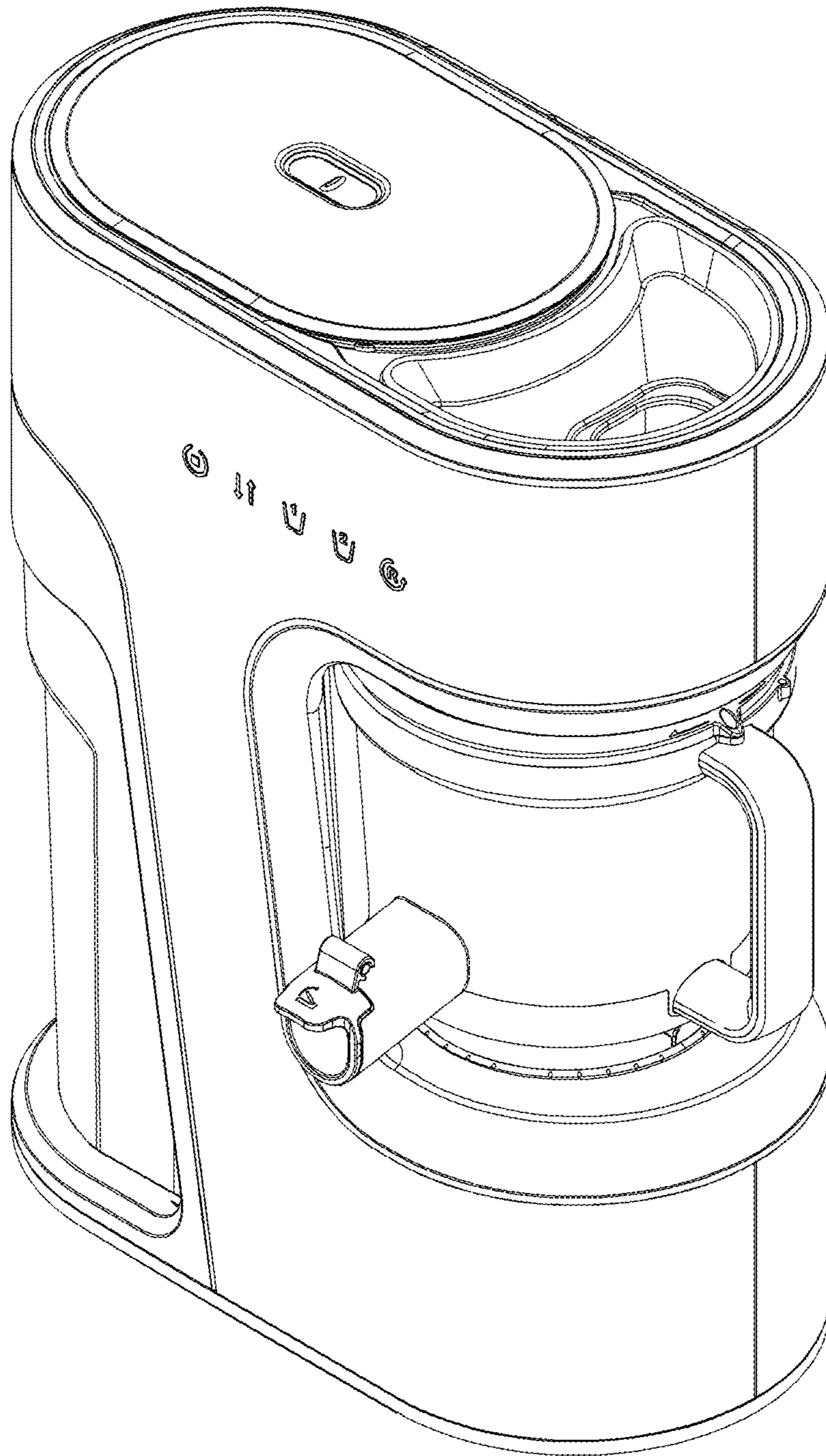

FIG. 2

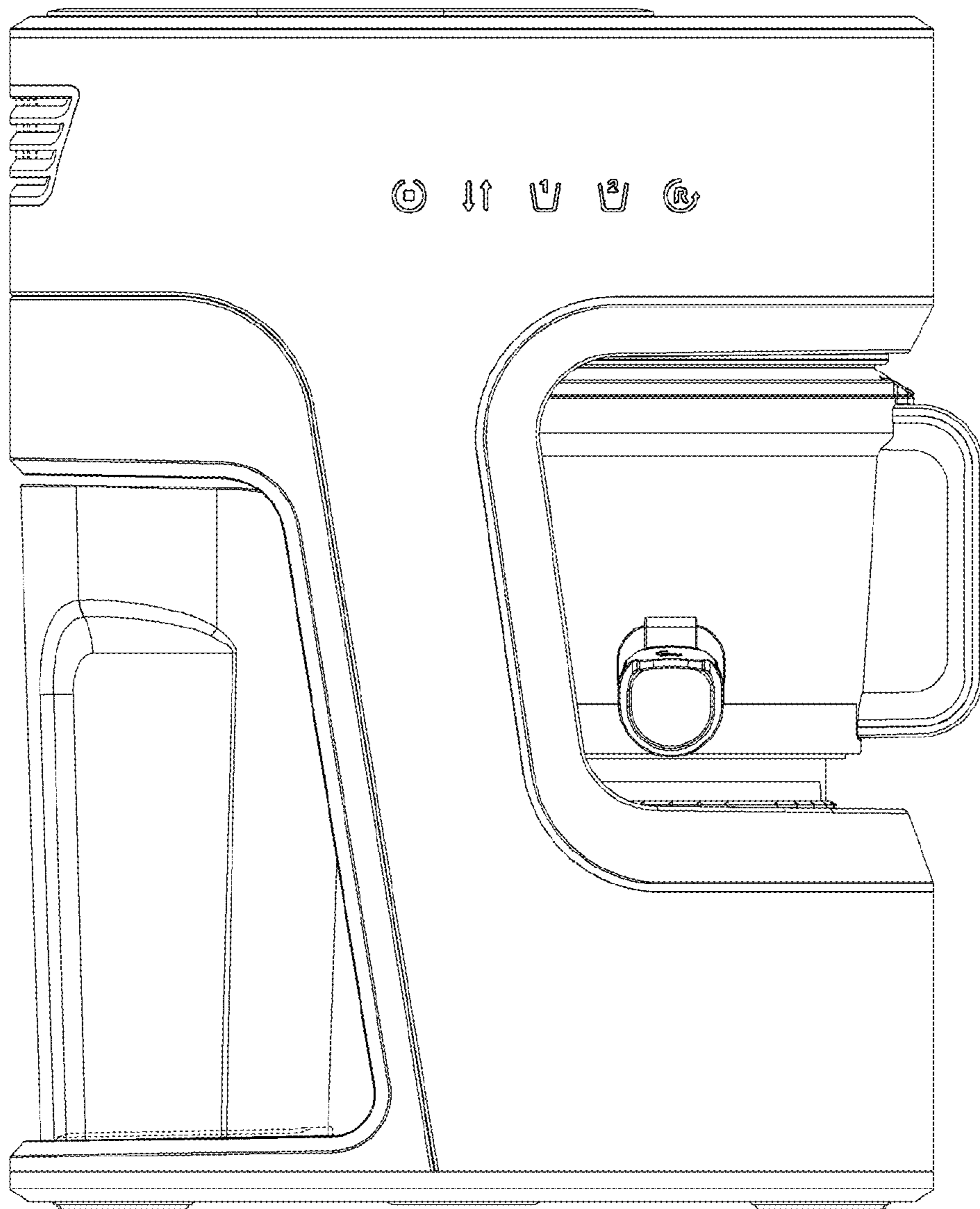

FIG. 3

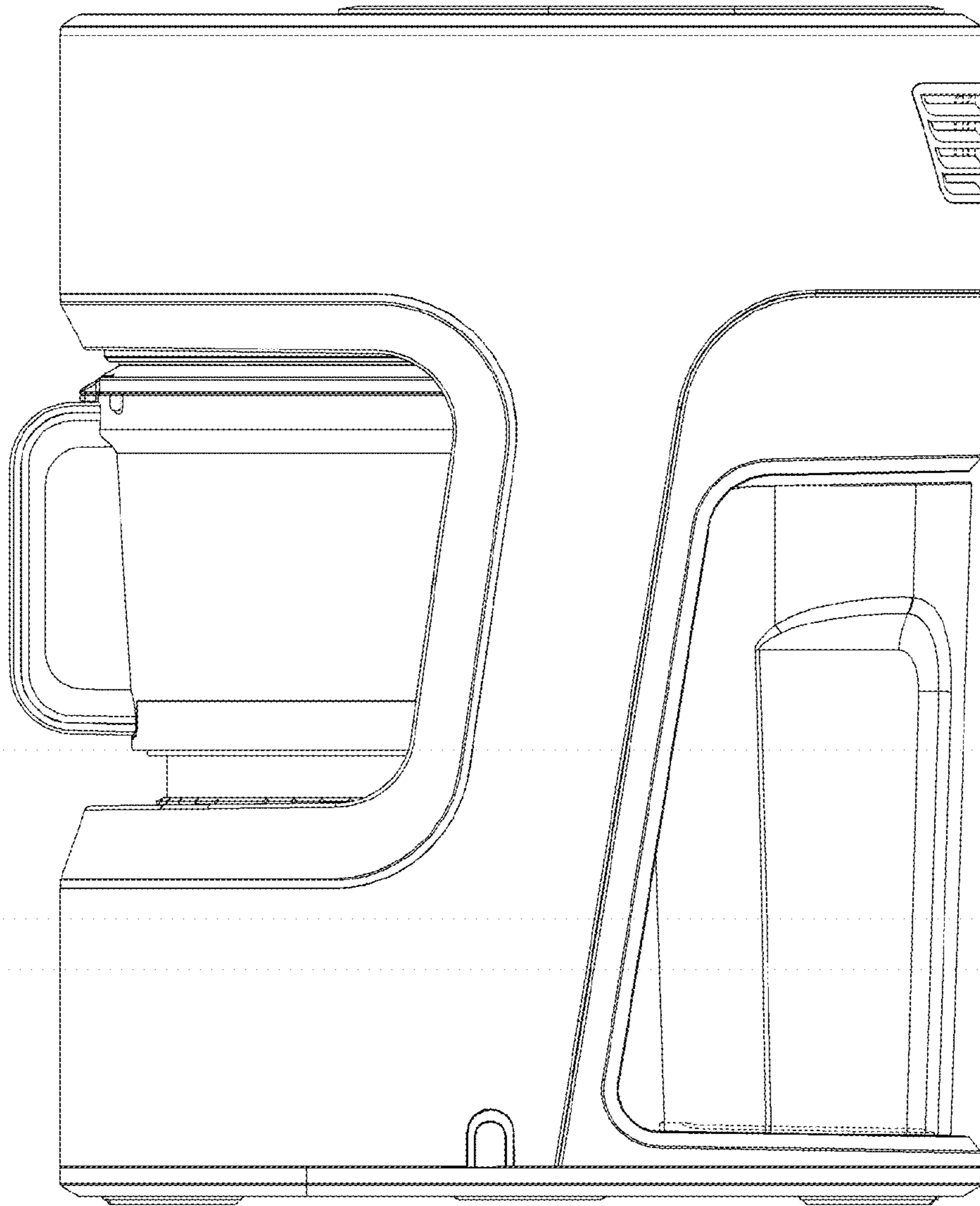

FIG. 4

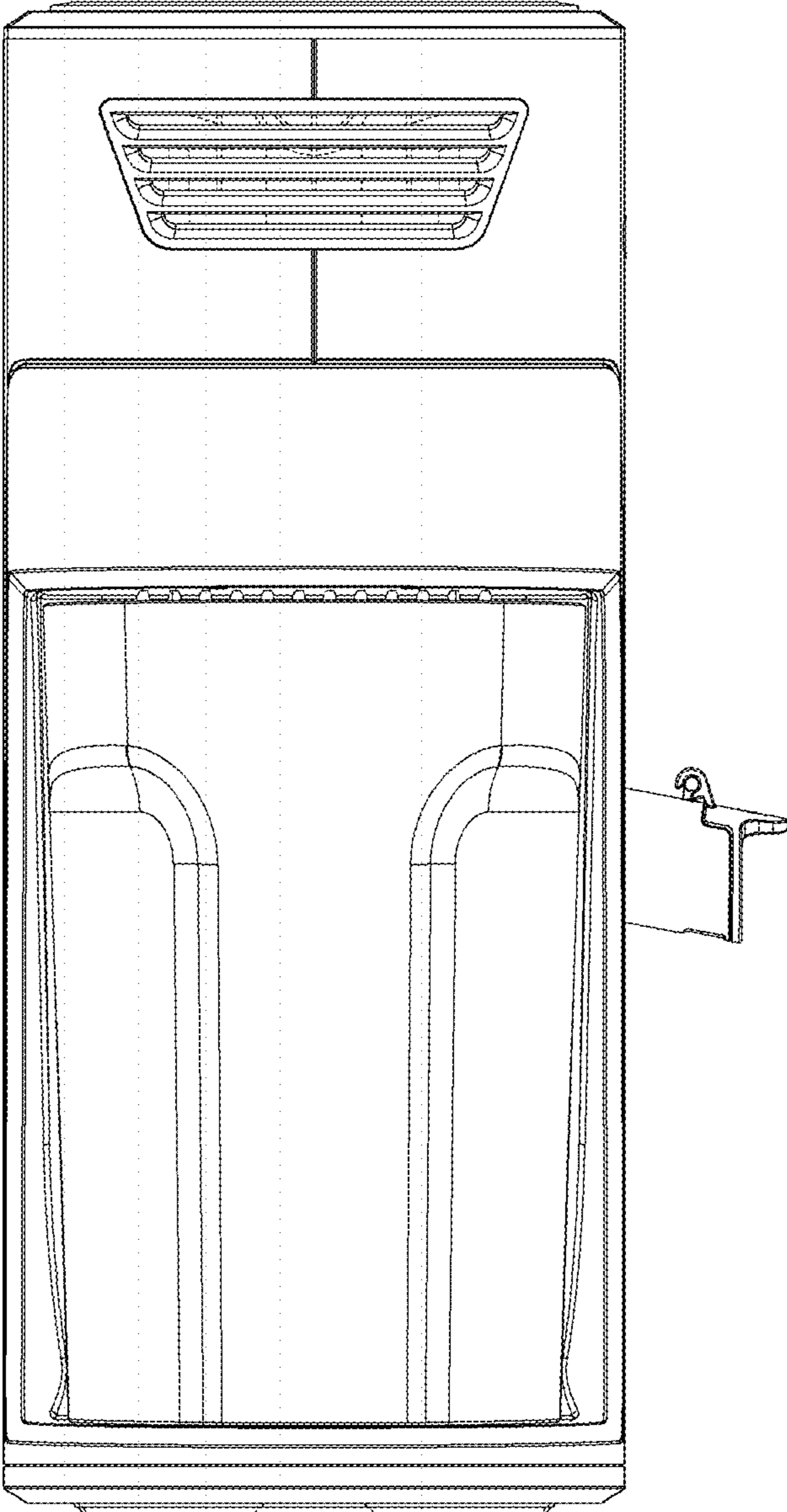

FIG. 5

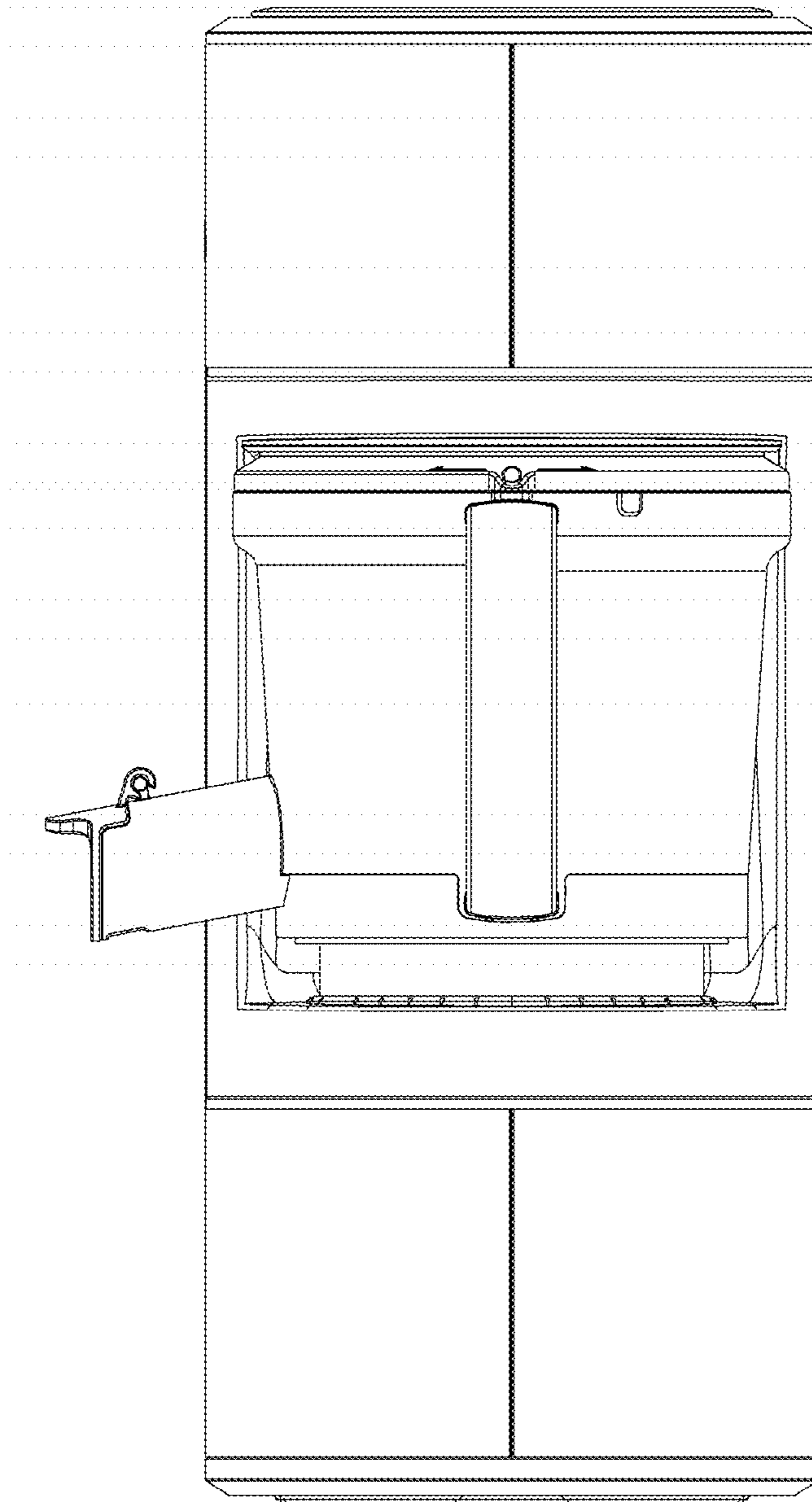

FIG. 6

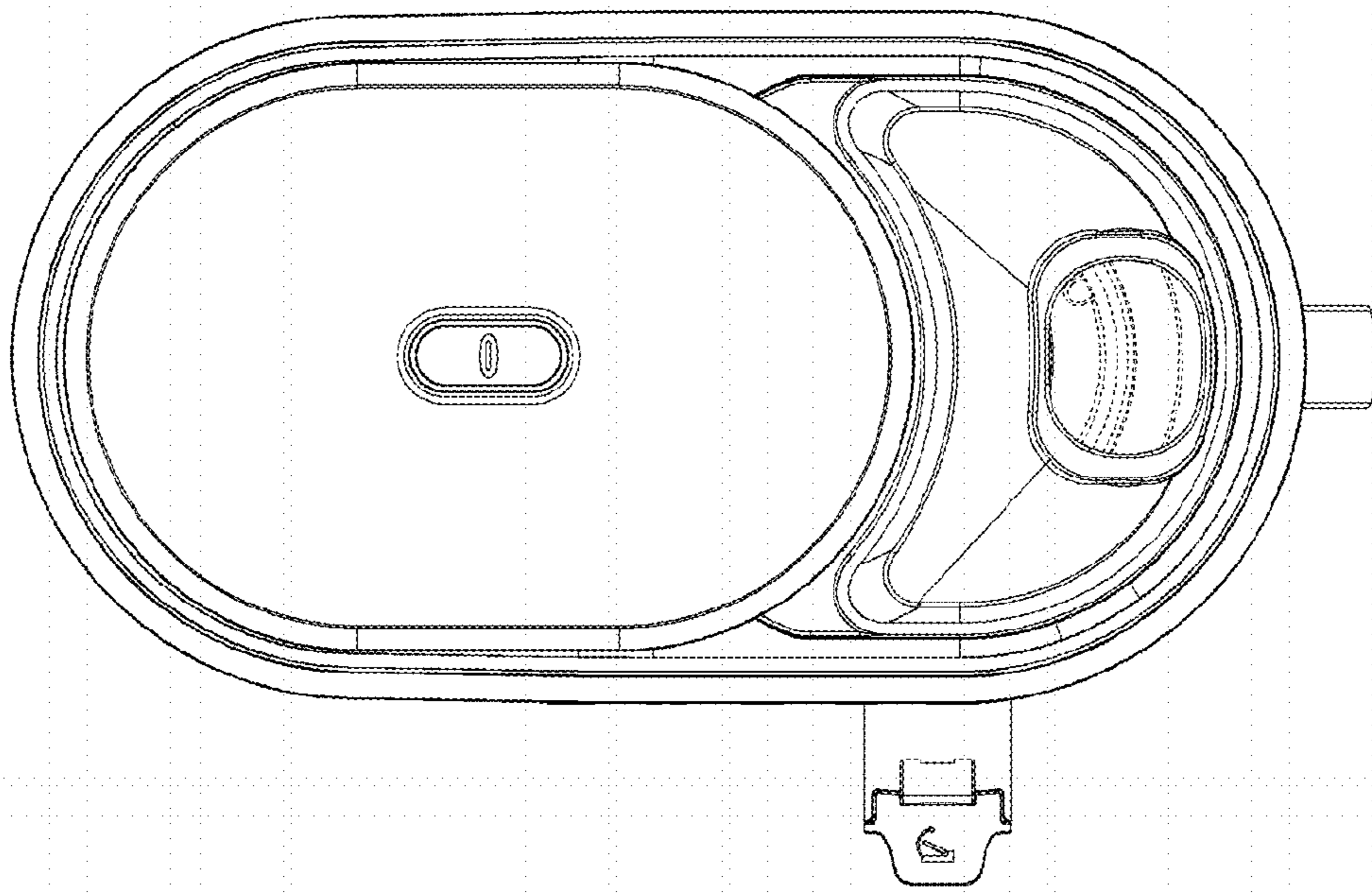

FIG. 7

