



US00D764123S

(12) **United States Design Patent**
Kim et al.

(10) **Patent No.:** **US D764,123 S**

(45) **Date of Patent:** **** Aug. 16, 2016**

(54) **WASHING MACHINE**

(71) Applicant: **LG ELECTRONICS INC.**, Seoul (KR)

(72) Inventors: **Youngjong Kim**, Seoul (KR); **Kyubum Lee**, Seoul (KR)

(73) Assignee: **LG ELECTRONICS INC.**, Seoul (KR)

(**) Term: **15 Years**

(21) Appl. No.: **29/544,546**

(22) Filed: **Nov. 4, 2015**

(30) **Foreign Application Priority Data**

Jun. 24, 2015 (KR) 30-2015-0031917

(51) **LOC (10) Cl.** **15-05**

(52) **U.S. Cl.**
USPC **D32/6**

(58) **Field of Classification Search**
USPC D32/1, 5-6, 7, 8, 25, 28, 29
CPC ... D06F 33/02; D06F 39/02; D06F 2204/065;
D06F 25/00; D06F 35/006
See application file for complete search history.

(56) **References Cited**

U.S. PATENT DOCUMENTS

D169,113 S * 3/1953 Sundberg D32/6
D169,351 S * 4/1953 Boldt D32/6
D233,470 S * 10/1974 Hall D32/6

4,429,817 A * 2/1984 Ikeda D06F 39/022
222/252
D374,954 S * 10/1996 Katz D32/6
D465,308 S * 11/2002 Resuello D32/6
D654,640 S * 2/2012 Song D32/6
D667,179 S * 9/2012 Jeon D32/6
D694,965 S * 12/2013 Lee D32/6
D701,657 S * 3/2014 Chung D32/6
D701,658 S * 3/2014 Chung D32/6
D733,372 S * 6/2015 Song D32/6

* cited by examiner

Primary Examiner — Michael A. Pratt

Assistant Examiner — Michelle E Wilson

(74) *Attorney, Agent, or Firm* — Dentons US LLP

(57) **CLAIM**

We claim the ornamental design for a washing machine, as shown and described.

DESCRIPTION

FIG. 1 is a perspective view of a washing machine showing our new design:

FIG. 2 is a front elevation view thereof;

FIG. 3 is a rear elevation view thereof;

FIG. 4 is a left-side elevation view thereof;

FIG. 5 is a right-side elevation view thereof;

FIG. 6 is a top plan view thereof;

FIG. 7 is a bottom plan view thereof; and,

FIG. 8 is a perspective view in a state of use thereof.

The broken lines represent unclaimed portions of the washing machine and form no part of the claimed design.

1 Claim, 5 Drawing Sheets

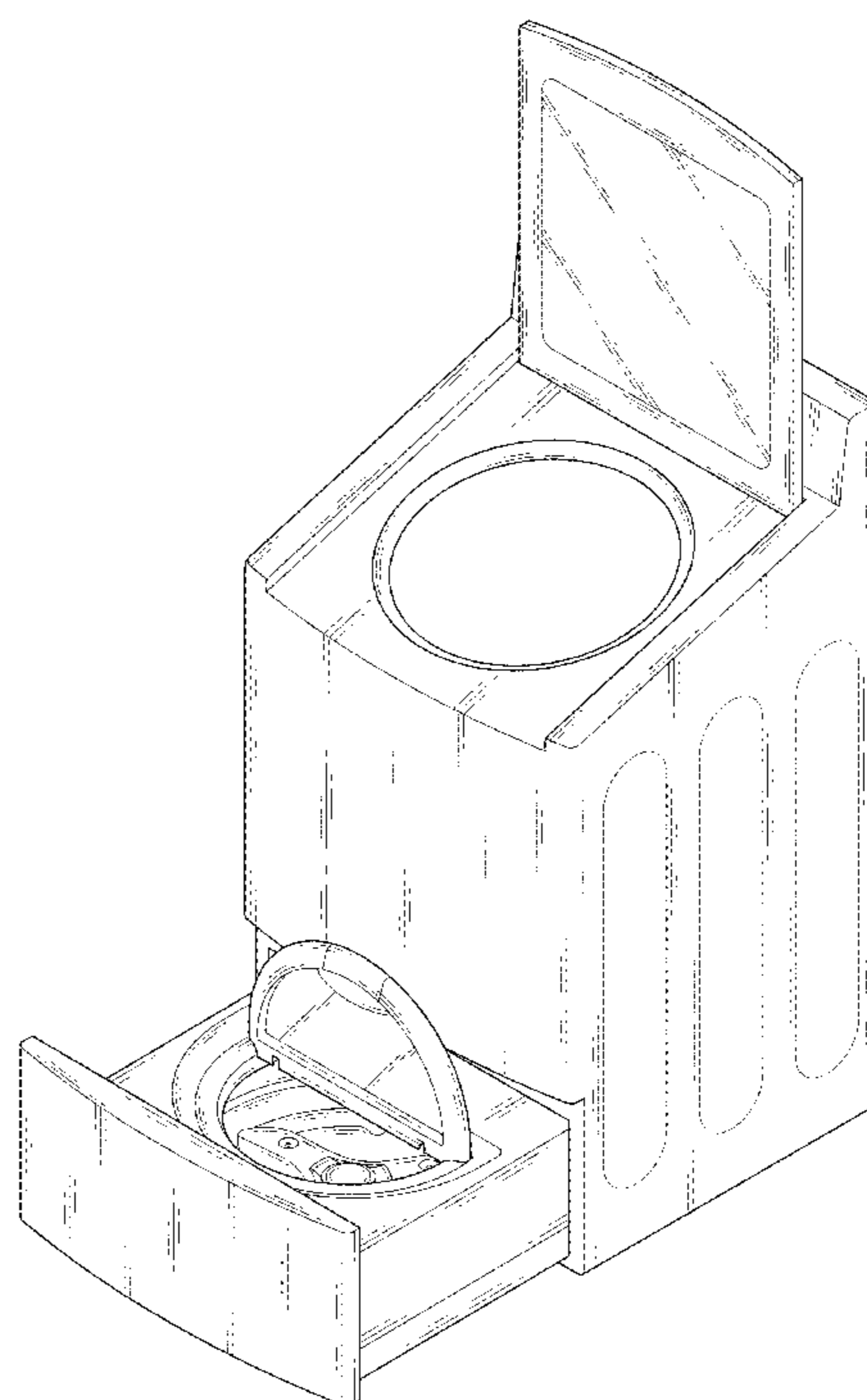
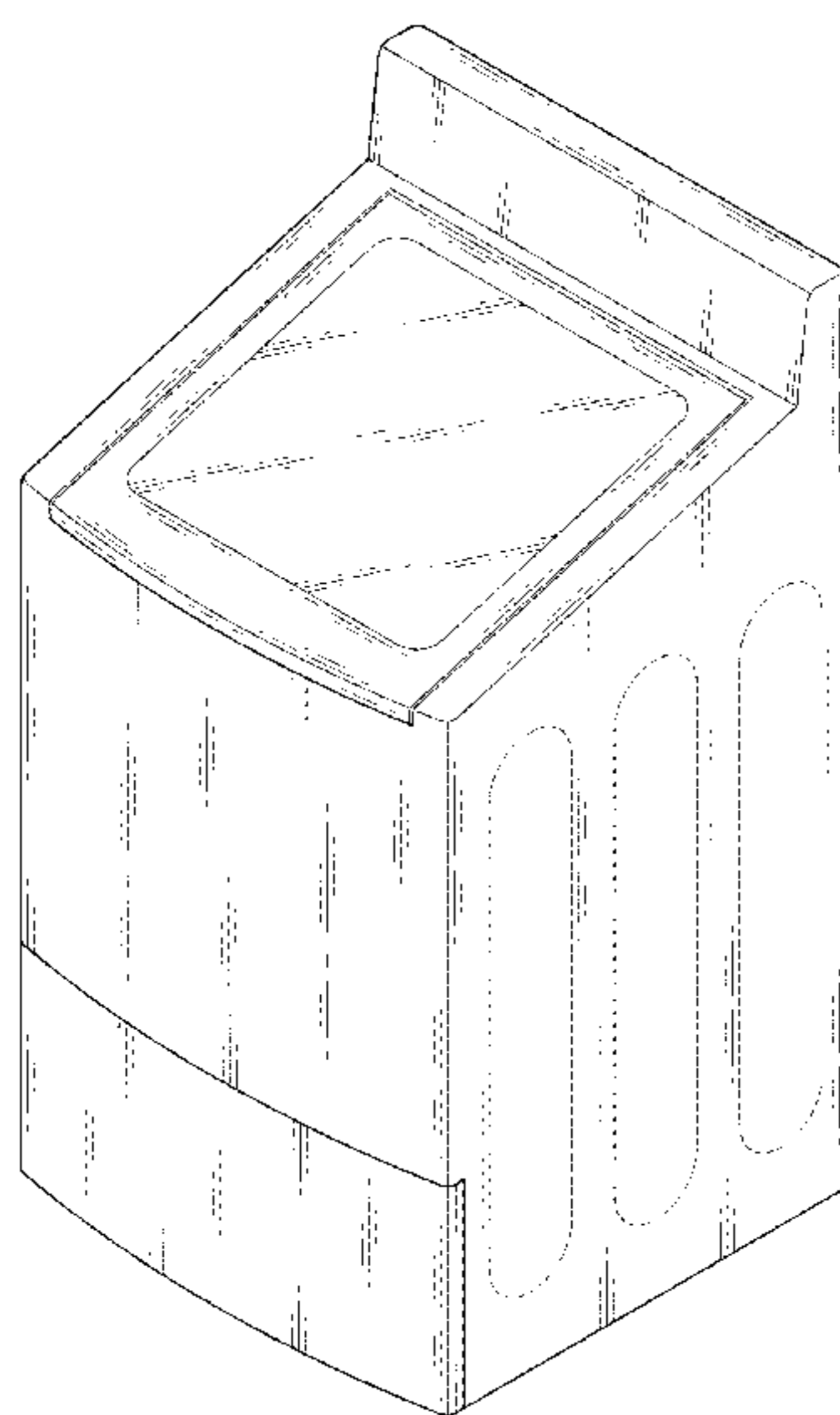

FIG. 1

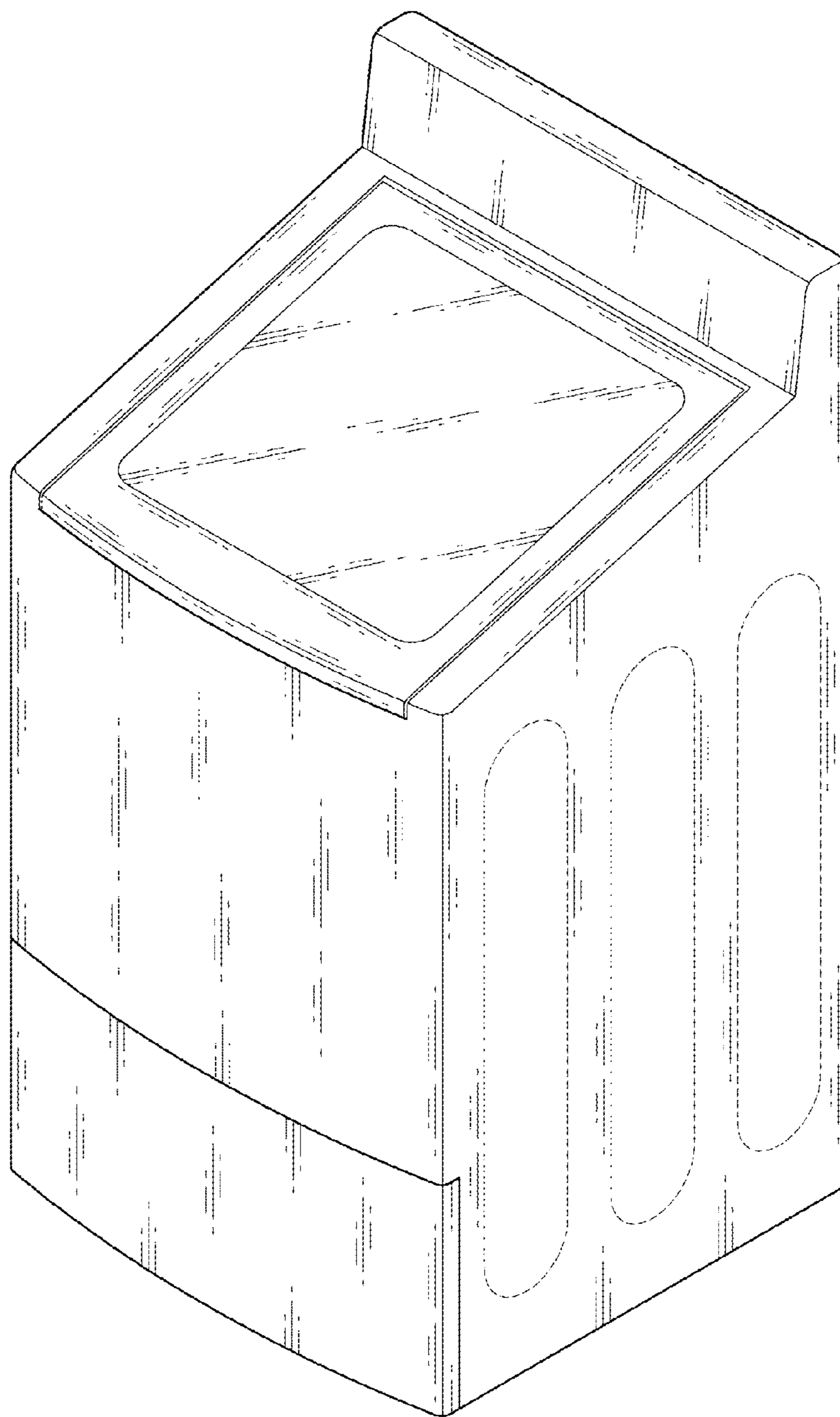

FIG. 2

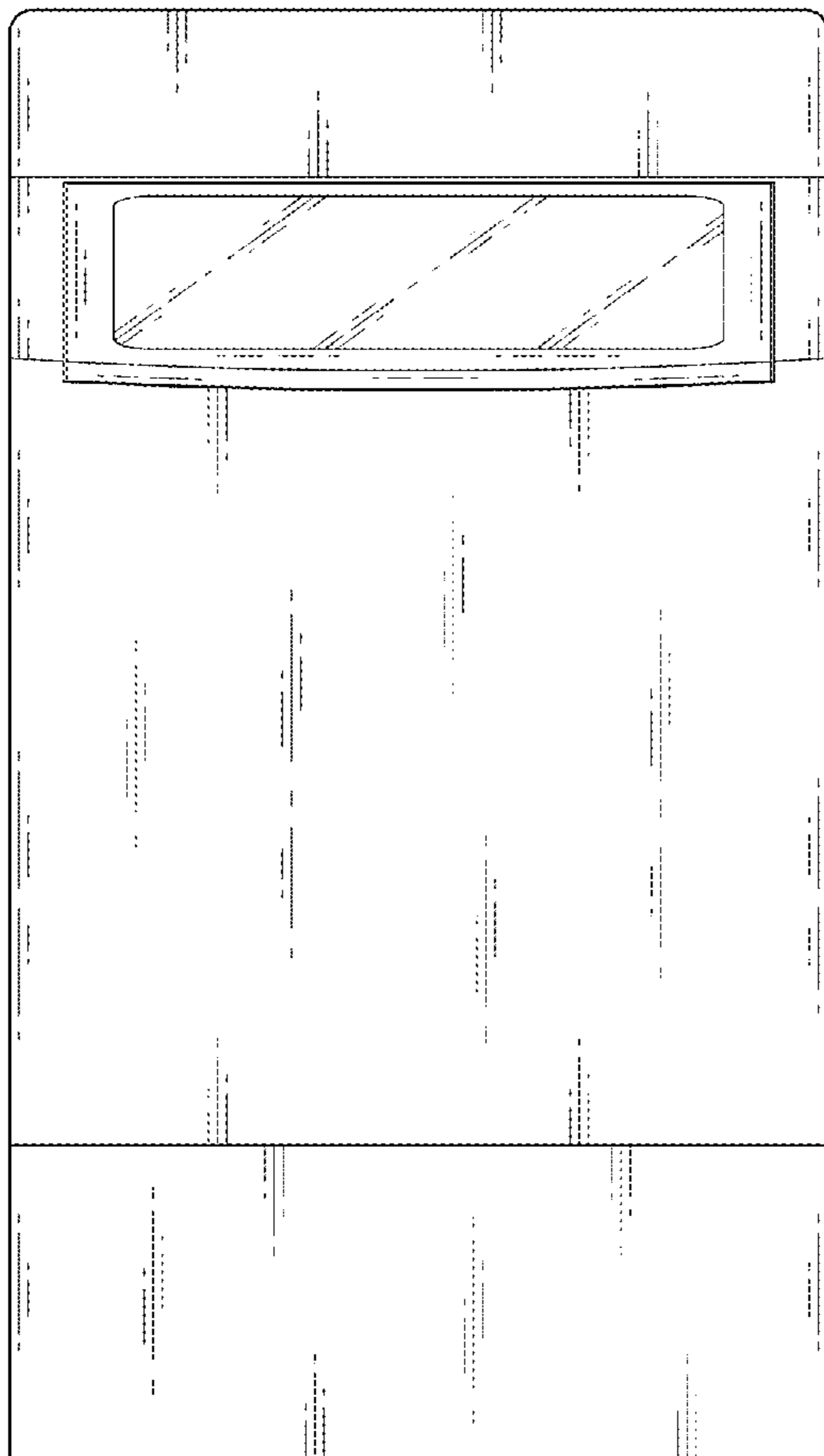

FIG. 3

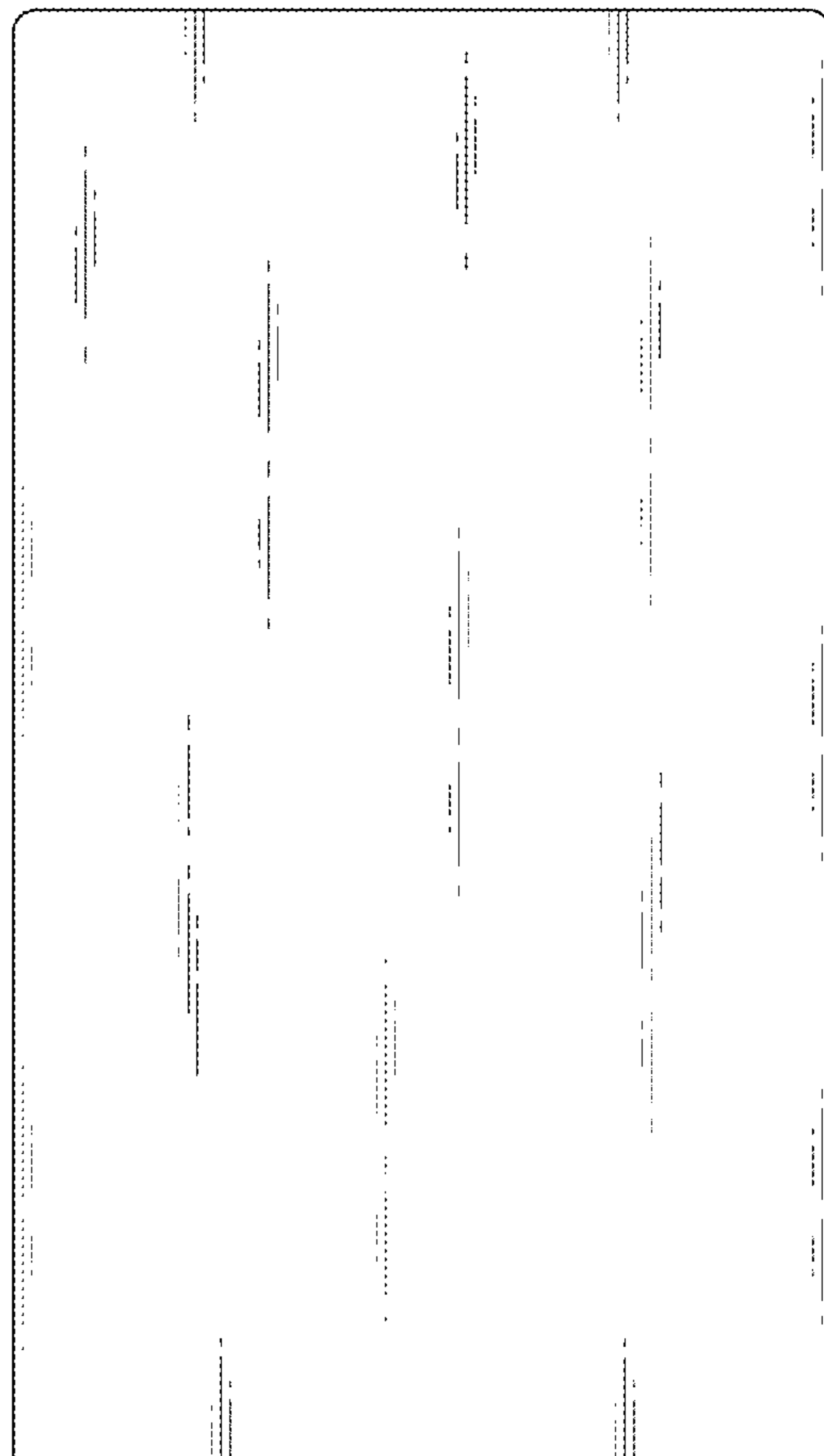

FIG. 4

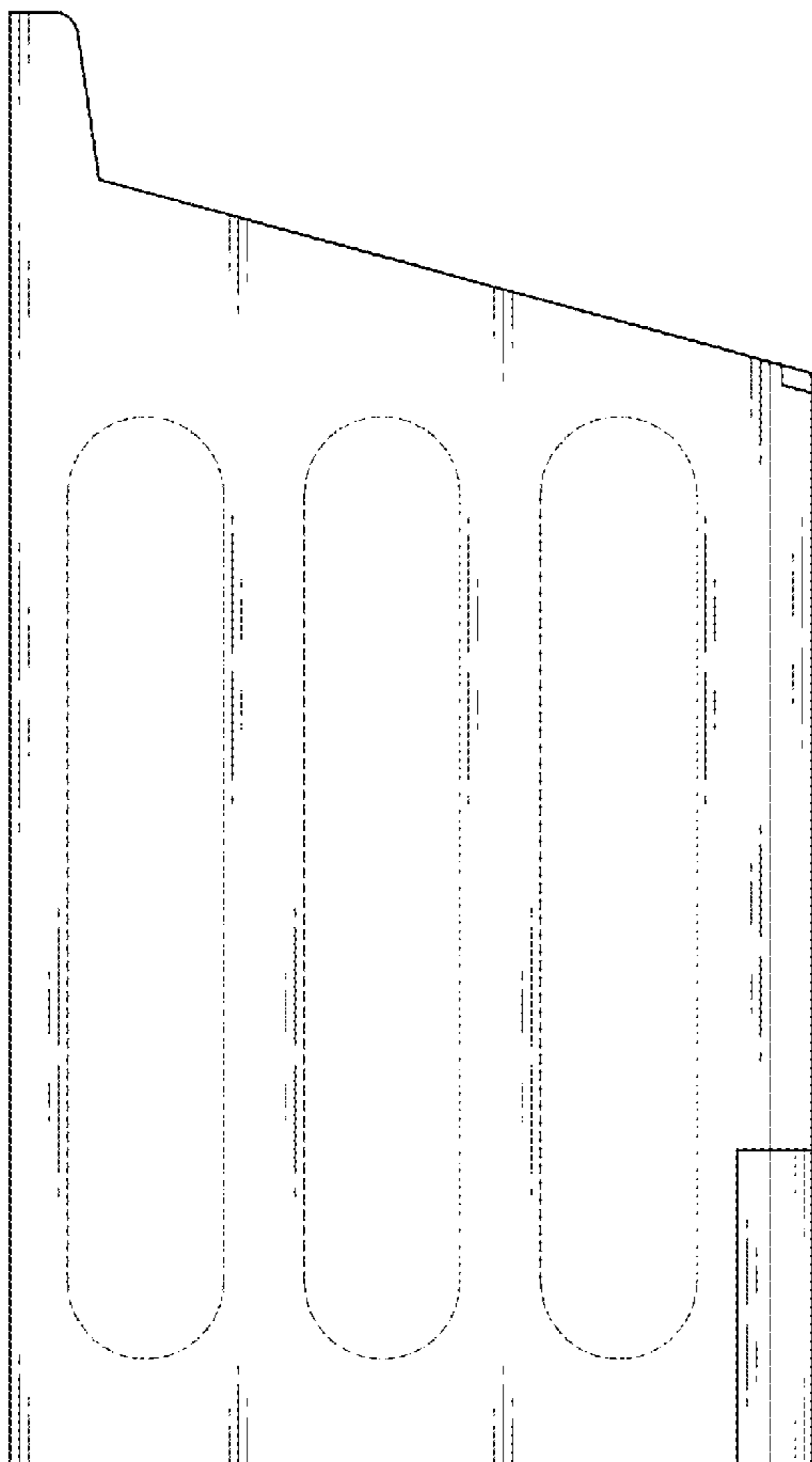

FIG. 5

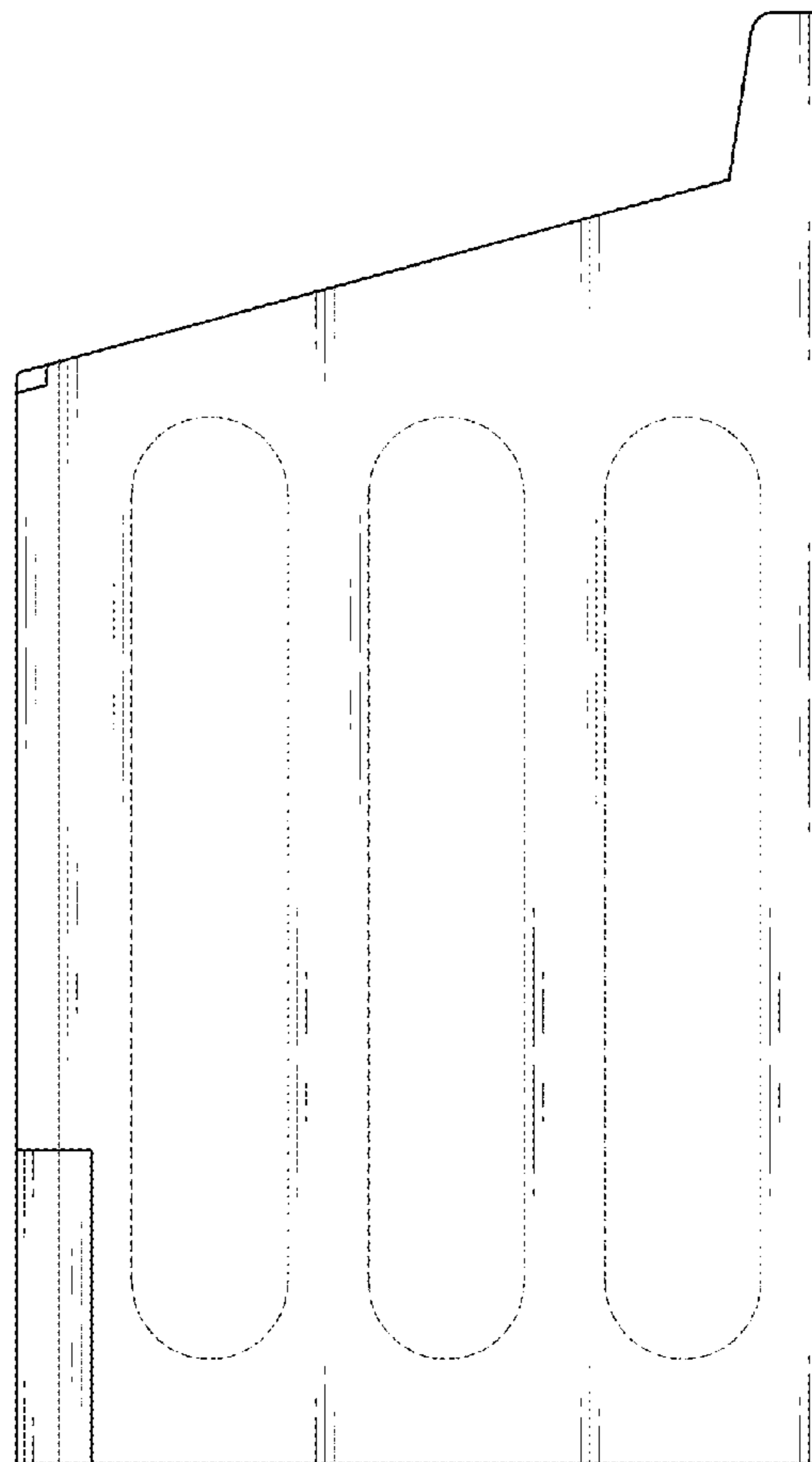

FIG. 6

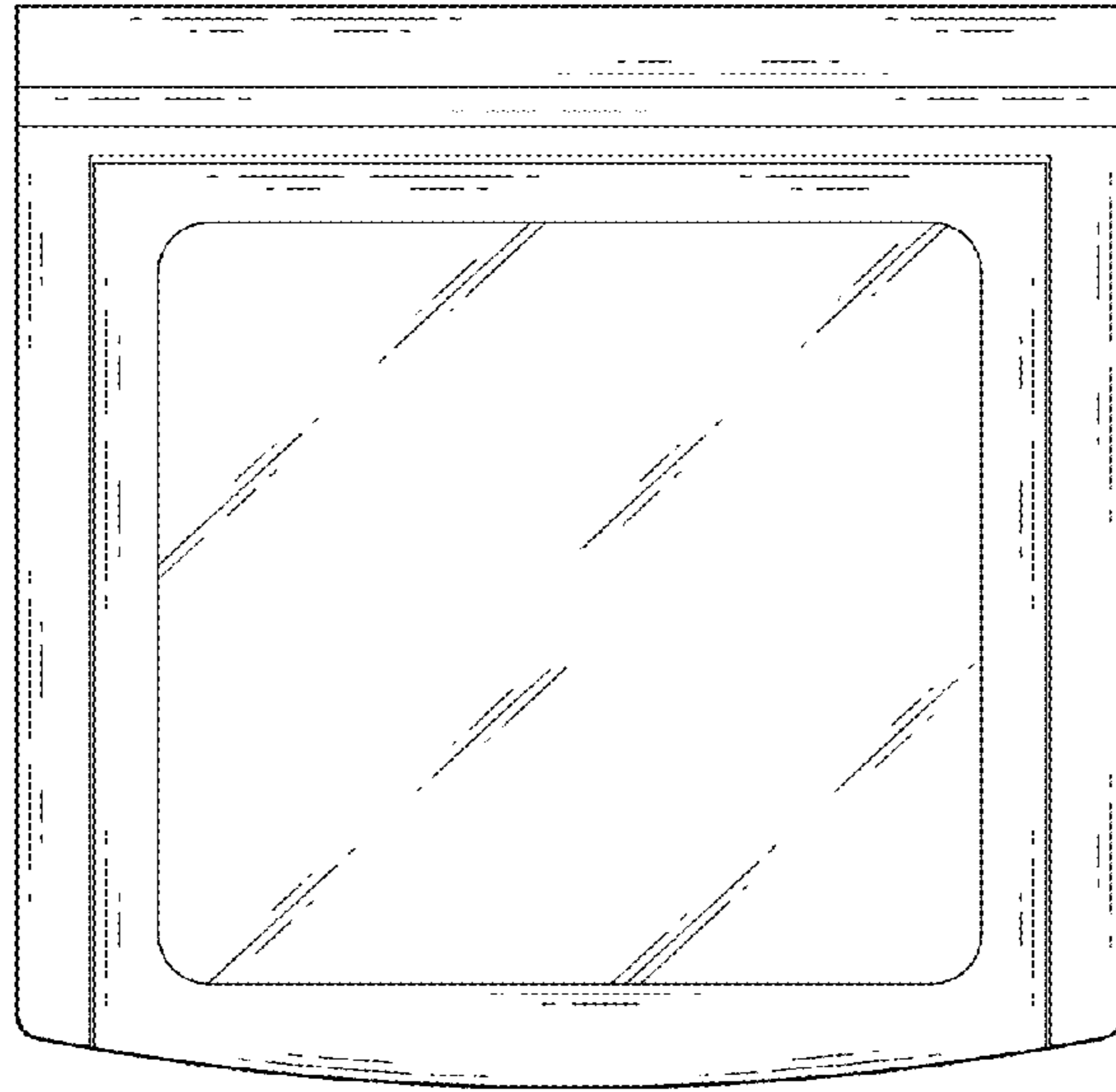

FIG. 7

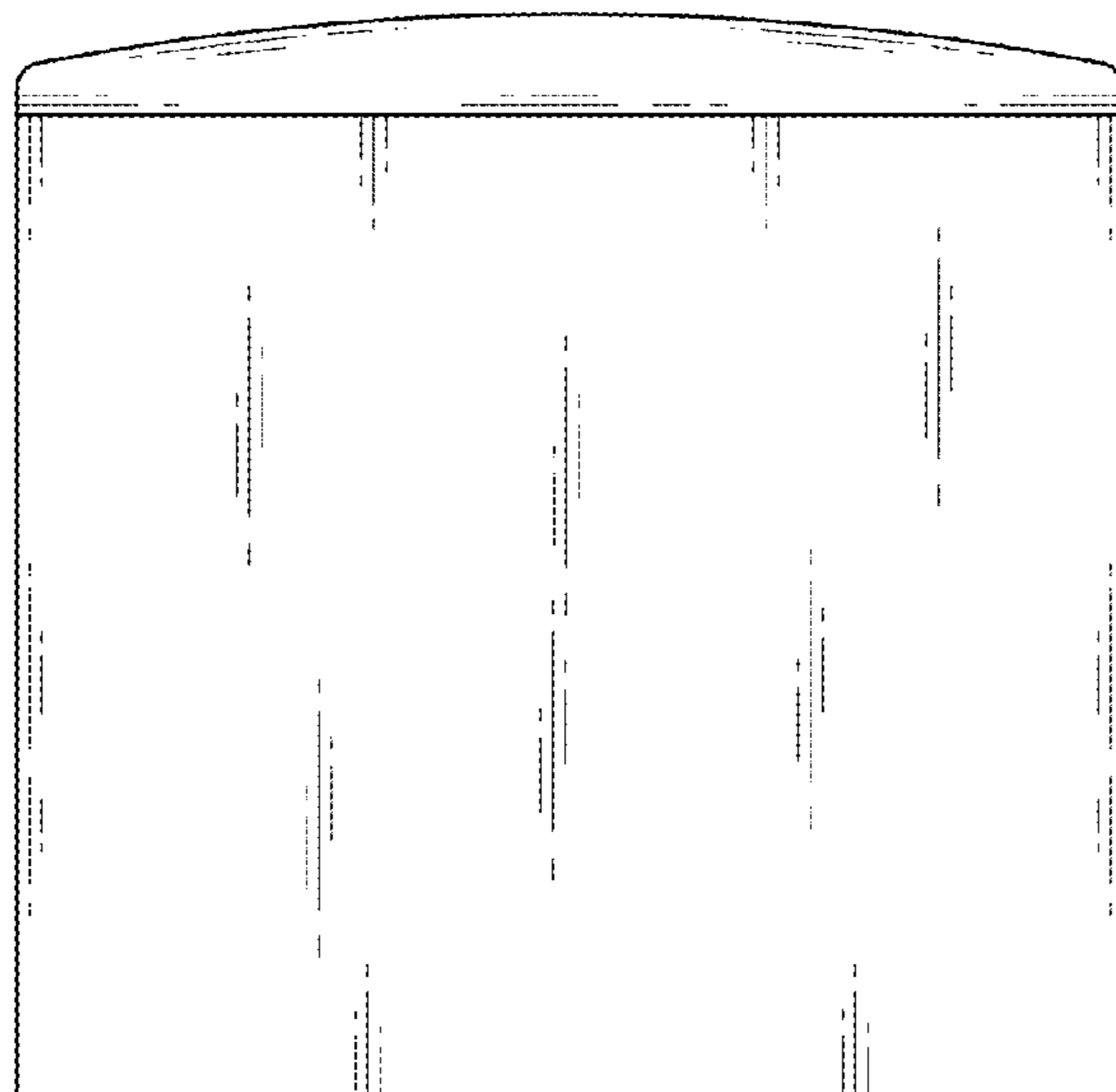

FIG. 8

