



US00D764114S

(12) **United States Design Patent**  
**Teller et al.**

(10) **Patent No.:** **US D764,114 S**

(45) **Date of Patent:** **\*\* \*Aug. 16, 2016**

(54) **COSMETIC PRODUCT CONTAINER**

(56) **References Cited**

(71) Applicant: **EOS PRODUCTS, LLC**, New York, NY (US)

(72) Inventors: **Jonathan Teller**, New York, NY (US);  
**Sanjiv Mehra**, New York, NY (US);  
**Peter Waxman**, New York, NY (US);  
**Joseph Speter**, New York, NY (US);  
**Sherry Jhavar**, New York, NY (US);  
**Hamish Campbell**, New York, NY (US)

(73) Assignee: **EOS PRODUCTS, LLC**, New York, NY (US)

(\*) Notice: This patent is subject to a terminal disclaimer.

(\*\*) Term: **14 Years**

(21) Appl. No.: **29/488,849**

(22) Filed: **Apr. 23, 2014**

(51) **LOC (10) Cl.** ..... **28-03**

(52) **U.S. Cl.**  
USPC ..... **D28/82**; D28/88; D9/519; D9/554;  
D9/551

(58) **Field of Classification Search**  
USPC ..... D28/85-91, 82, 76-79, 4-7, 8.1, 8.2, 9;  
D9/502, 570, 503, 504, 519, 552, 554,  
D9/557, 564, 566, 567, 600, 726, 601, 551,  
D9/521, 416, 529, 438, 435; D24/101,  
D24/102; D1/127, 130; D5/43, 44, 56, 59,  
D5/60, 62, 55; 132/316, 317, 318, 320;  
206/581, 823, 385; D3/265, 270,  
D3/271.1; 424/467; D14/489  
CPC ..... B65D 1/00; B65D 3/00; B65D 5/00;  
B65D 11/00; B65D 25/00; B65D 81/00  
See application file for complete search history.

U.S. PATENT DOCUMENTS

1,852,455	A	4/1932	Friedman	
2,745,642	A *	5/1956	Hermann	366/130
3,167,079	A *	1/1965	Weil	134/137
D206,463	S *	12/1966	Federighi	D9/502
5,044,496	A	9/1991	Tanaka	
D321,129	S *	10/1991	Giuseppe	D9/502
D380,672	S *	7/1997	Rowe	D9/669
D382,207	S *	8/1997	Rowe	D9/636

(Continued)

FOREIGN PATENT DOCUMENTS

JP	1136041	S	3/2002
JP	2001321140	A	11/2004

OTHER PUBLICATIONS

SIPO Office Action issued Jul. 17, 2014 in connection with CN Appl. No. 201080063211.X citing JP 2004-321410A and JP 1136041S (listed separately).

*Primary Examiner* — Marianne Pandozzi

*Assistant Examiner* — Jae Liang

(74) *Attorney, Agent, or Firm* — Marin & Ferraro, LLP

(57) **CLAIM**

The ornamental design for a cosmetic product container, as shown and described.

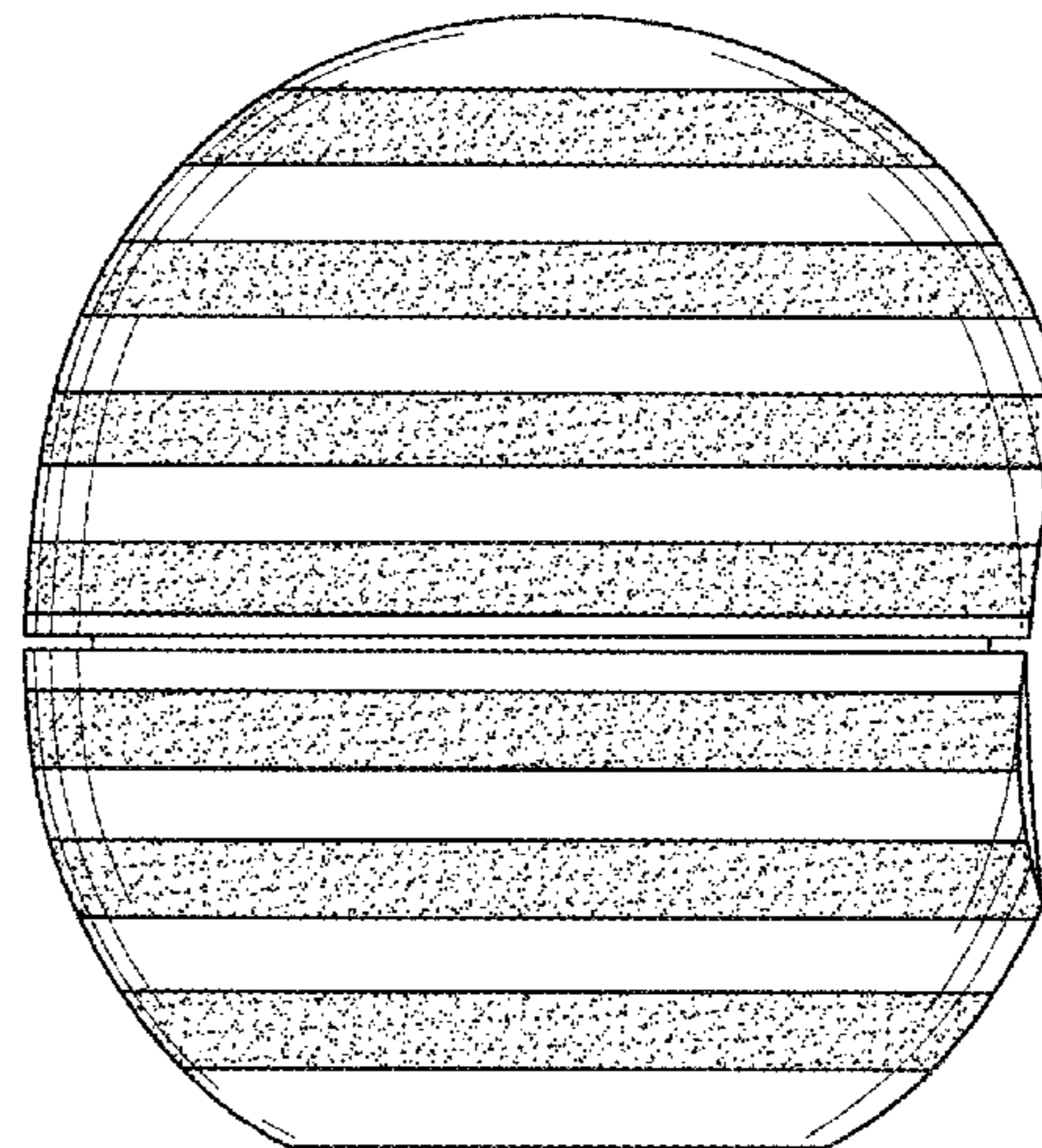
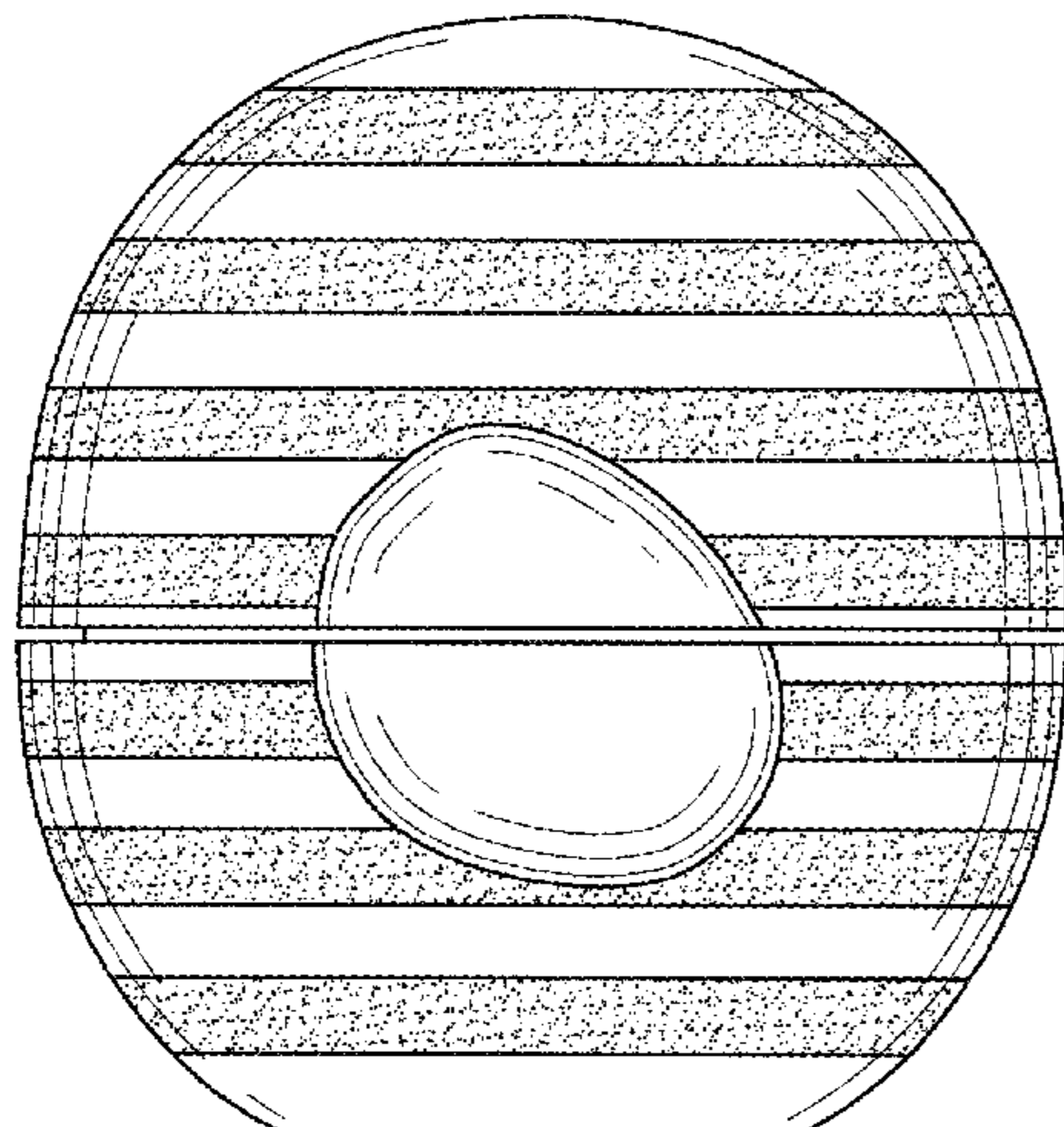
**DESCRIPTION**

FIG. 1 is a front elevational view of a cosmetic product container showing my new design; FIG. 2 is a left side elevational view thereof; FIG. 3 is a right side elevational view thereof; FIG. 4 is a rear elevational view thereof; FIG. 5 is a top plan view thereof; and, FIG. 6 is a bottom plan view thereof.

The broken lines in the drawing depict portions of the cosmetic product container that form no part of the claimed design.

The stippling in FIGS. 1-6 shows contrast in appearance.

**1 Claim, 3 Drawing Sheets**



(56)

**References Cited**

U.S. PATENT DOCUMENTS

6,193,427 B1 2/2001 Benguigui  
6,391,972 B1 5/2002 Hatakeyama  
D474,021 S \* 5/2003 Lenaerts ..... D3/302  
D521,868 S \* 5/2006 Arima ..... D9/502

D625,469 S \* 10/2010 Dubitsky et al. .... D28/84  
D635,371 S \* 4/2011 Schilling et al. .... D5/60  
D644,939 S \* 9/2011 Teller ..... D9/726  
D656,741 S \* 4/2012 Snyder ..... D5/60  
8,444,337 B2 \* 5/2013 Teller ..... 401/88  
D726,219 S \* 4/2015 Chaudhri et al. .... D14/489

\* cited by examiner



FIG. 1

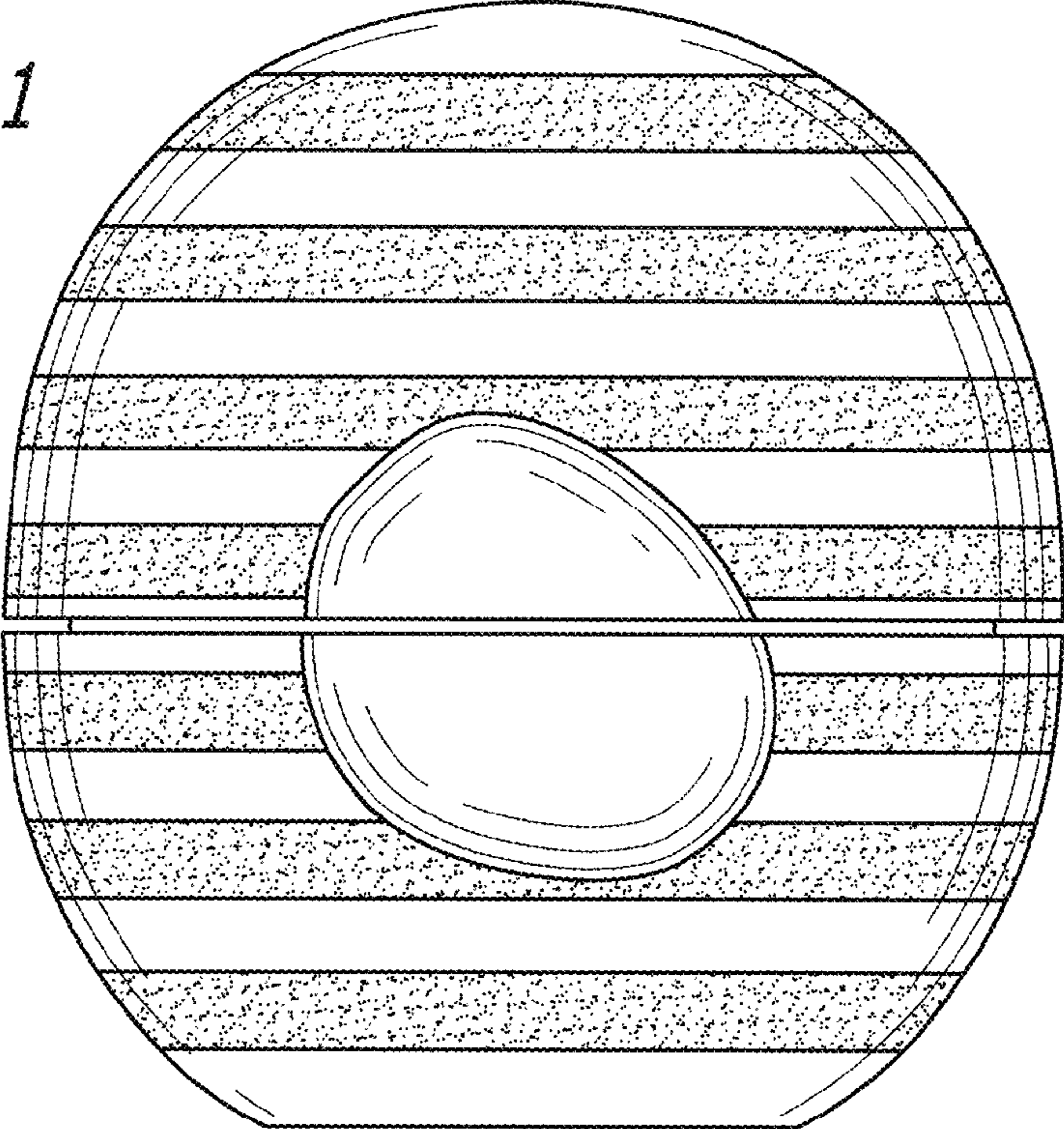
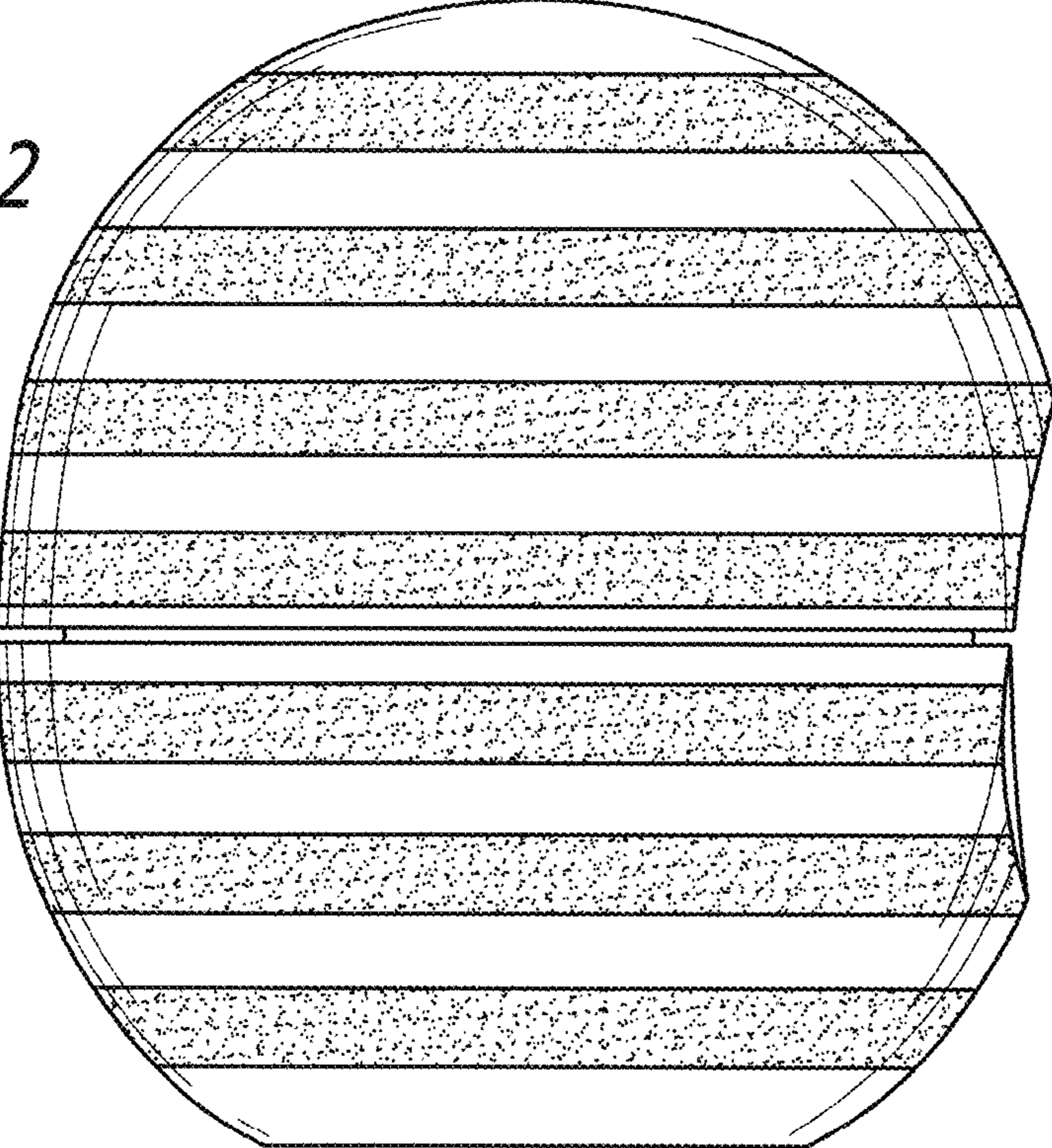
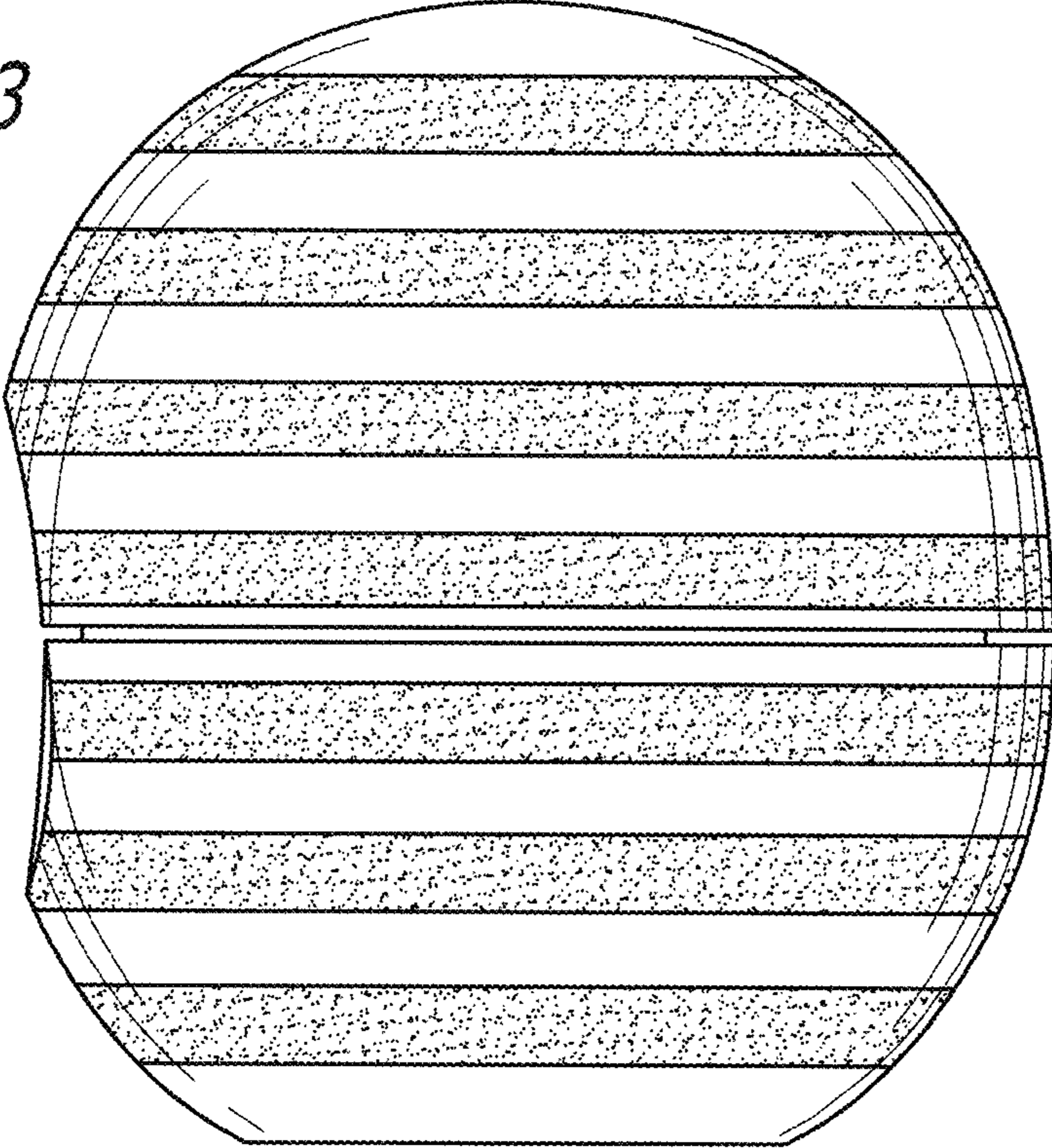


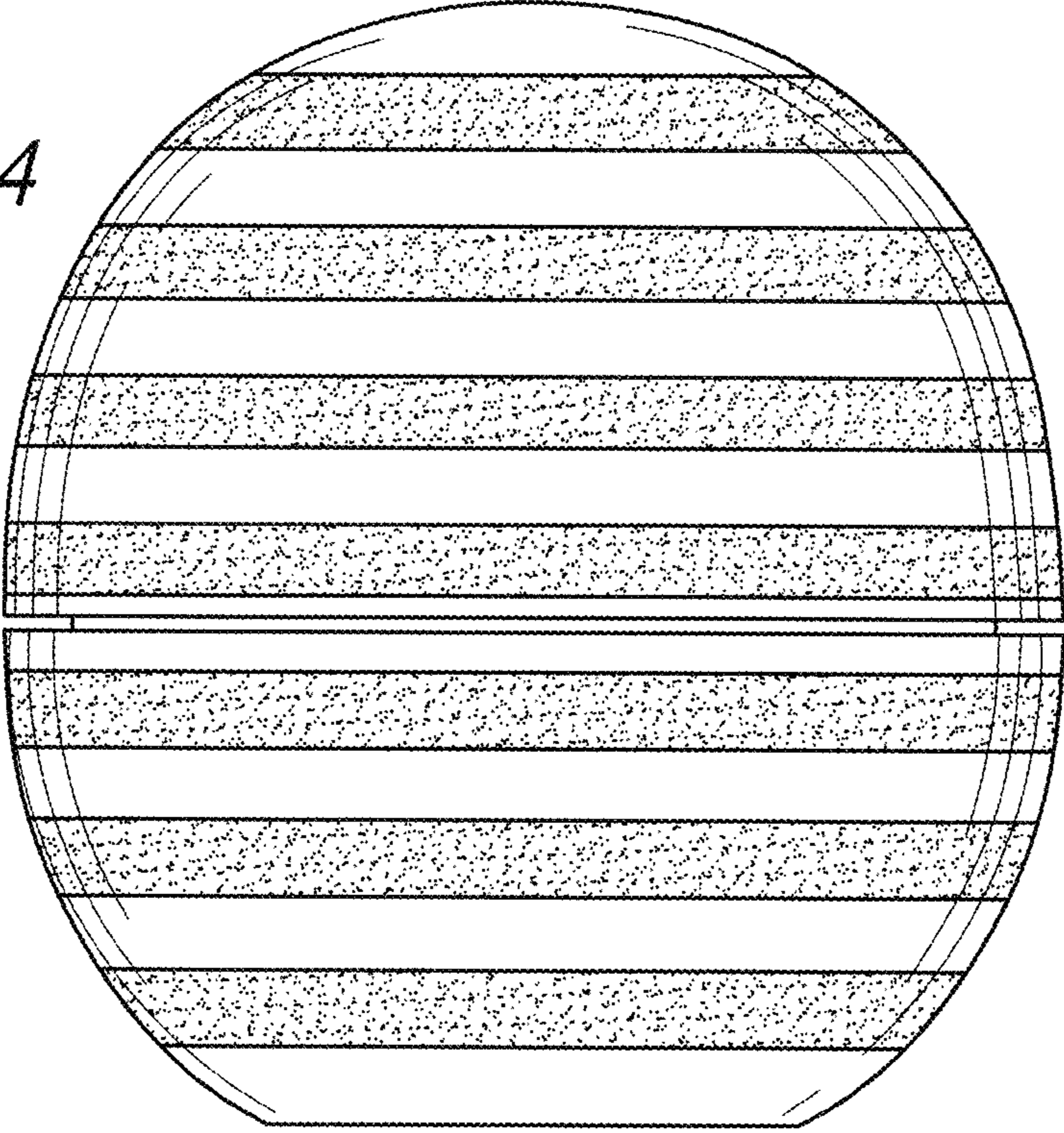
FIG. 2



*FIG. 3*

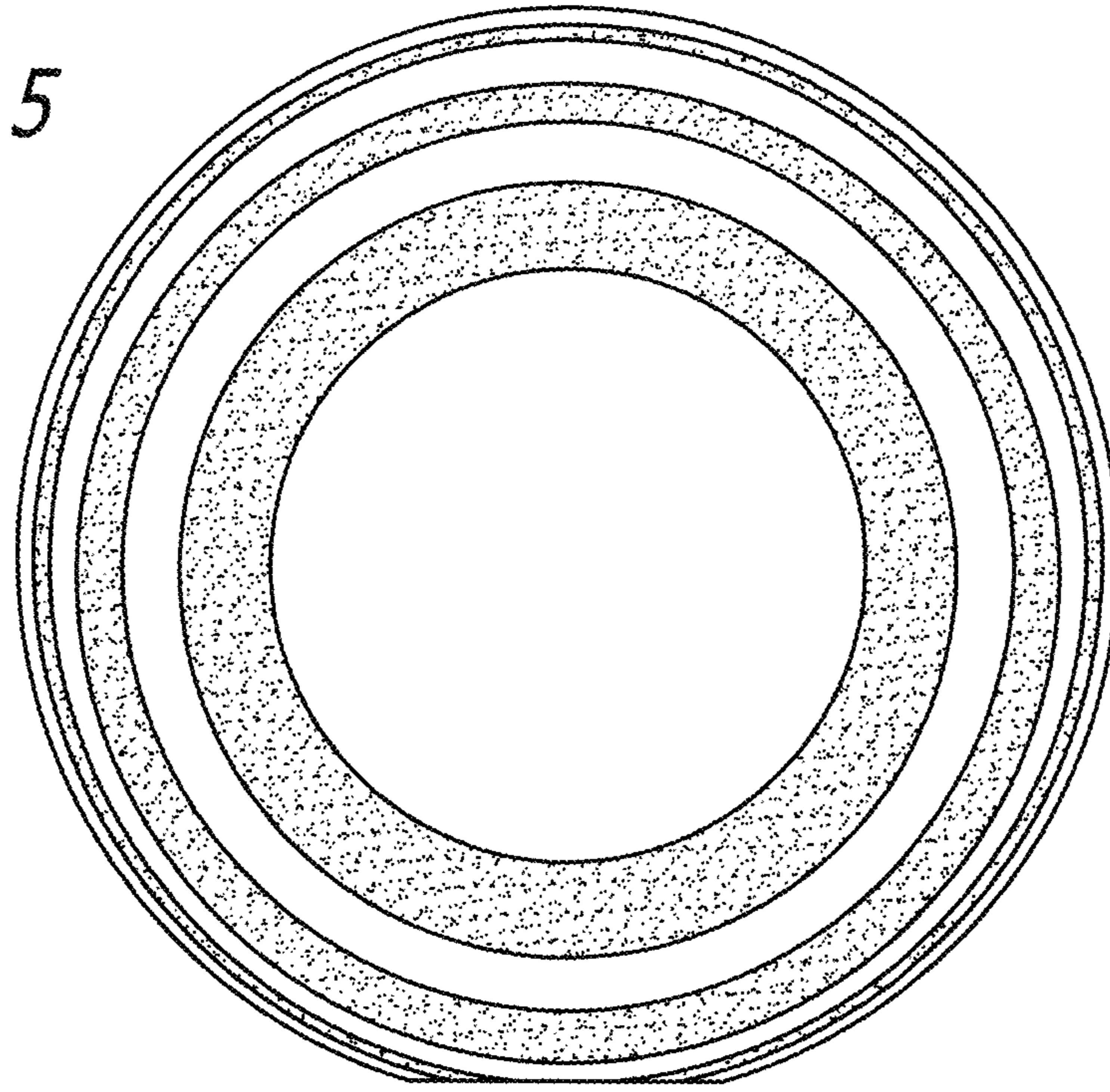


*FIG. 4*





*FIG. 5*



*FIG. 6*

