



US00D764111S

(12) **United States Design Patent**
Teller et al.

(10) **Patent No.:** **US D764,111 S**

(45) **Date of Patent:** **** *Aug. 16, 2016**

(54) **COSMETIC PRODUCT CONTAINER**

(71) Applicant: **EOS PRODUCTS, LLC**, New York, NY (US)

(72) Inventors: **Jonathan Teller**, New York, NY (US);
Sanjiv Mehra, New York, NY (US);
Peter Waxman, New York, NY (US);
Joseph Speter, New York, NY (US);
Sherry Jhavar, New York, NY (US);
Hamish Campbell, New York, NY (US)

(73) Assignee: **EOS PRODUCTS, LLC**, New York, NY (US)

(*) Notice: This patent is subject to a terminal disclaimer.

(**) Term: **14 Years**

(21) Appl. No.: **29/488,104**

(22) Filed: **Apr. 16, 2014**

(51) **LOC (10) Cl.** **28-03**

(52) **U.S. Cl.**
USPC **D28/82**; D28/88; D9/519; D9/552;
D9/554

(58) **Field of Classification Search**

USPC D28/85-91, 82, 76-79, 4-7, 8.1, 8.2, 9;
D9/502, 570, 503, 504, 519, 552, 554,
D9/557, 564, 566, 567, 600, 726, 601, 551,
D9/521, 416, 529, 438, 435; D24/101,
D24/102; D1/127, 130; D5/43, 44, 56, 59,
D5/60, 62, 55; 132/316, 317, 318, 320;
206/581, 823, 385; D3/265, 270,
D3/271.1; 424/467; D14/489

CPC B65D 1/00; B65D 3/00; B65D 5/00;
B65D 11/00; B65D 25/00; B65D 81/00

See application file for complete search history.

(56) **References Cited**

U.S. PATENT DOCUMENTS

1,852,455 A	4/1932	Friedman	
2,745,642 A *	5/1956	Hermann	366/130
3,167,079 A *	1/1965	Weil	134/137
3,292,840 A *	12/1966	Schmidt	220/4.25
3,494,515 A *	2/1970	Fattori	222/548
4,765,501 A *	8/1988	Kao	220/4.21

(Continued)

FOREIGN PATENT DOCUMENTS

JP	1136041 S	3/2002
JP	2001321140 A	11/2004

OTHER PUBLICATIONS

SIPO Office Action issued Jul. 17, 2014 in connection with CN Appl. No. 201080063211.X citing JP 2004-321410A and JP 1136041S.

Primary Examiner — Marianne Pandozzi

Assistant Examiner — Jae Liang

(74) *Attorney, Agent, or Firm* — Martin & Ferraro, LLP

(57) **CLAIM**

The ornamental design for a cosmetic product container, as shown and described.

DESCRIPTION

FIG. 1 is a front elevational view of a cosmetic product container showing my new design; FIG. 2 is a right side elevational view thereof; FIG. 3 is a left side elevational view thereof; FIG. 4 is a rear elevational view thereof; FIG. 5 is a top plan view thereof; and, FIG. 6 is a bottom plan view thereof.

The broken lines in the drawing depict portions of the cosmetic product container that form no part of the claimed design.

The stippling in FIGS. 1-6 shows contrast in appearance.

1 Claim, 3 Drawing Sheets

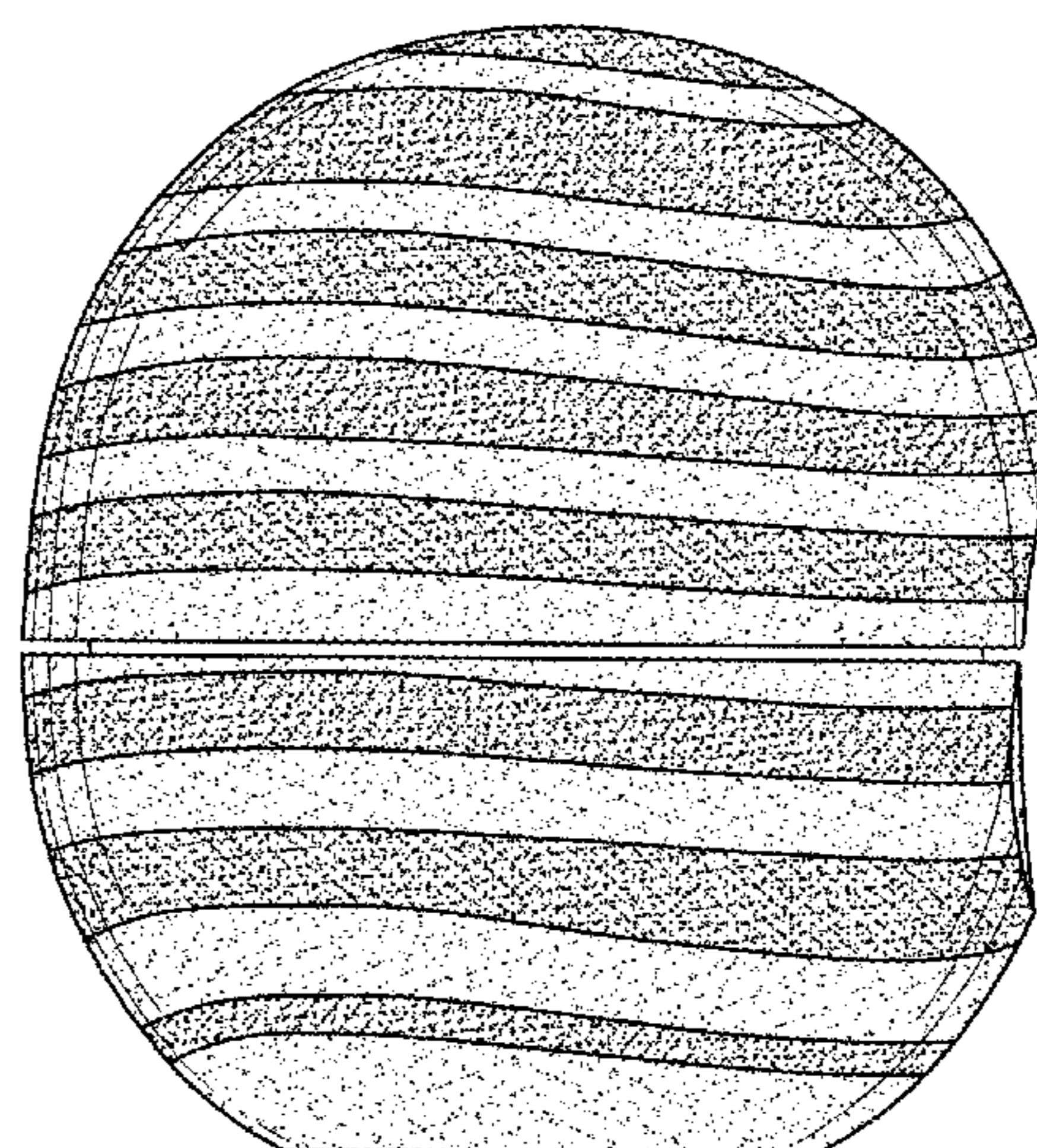
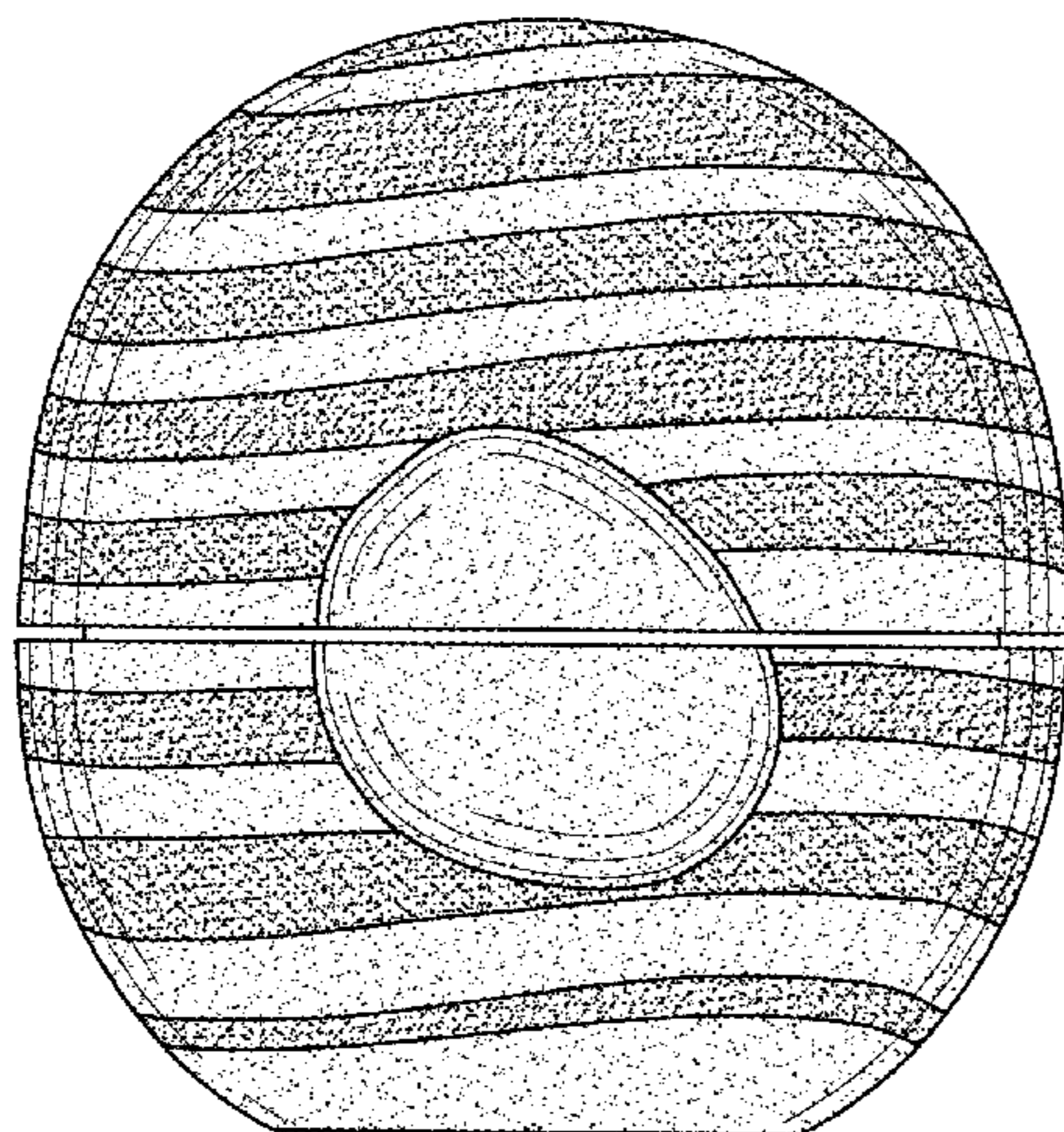

(56)

References Cited

U.S. PATENT DOCUMENTS

5,044,496 A 9/1991 Tanaka
 D322,558 S * 12/1991 Halm et al. D32/29.1
 D378,275 S * 3/1997 Rusnock et al. D9/545
 D396,382 S * 7/1998 Hsu D7/599
 D403,123 S * 12/1998 Sgariboldi D28/76
 6,193,427 B1 2/2001 Benguigui
 D443,826 S * 6/2001 Gnann et al. D9/537
 D450,882 S * 11/2001 Colwell et al. D28/4
 D452,586 S * 12/2001 Look D28/4
 D452,588 S * 12/2001 Look D28/4
 6,391,972 B1 5/2002 Hatakeyama
 D465,609 S * 11/2002 Jackel-Marken D28/4
 D465,733 S * 11/2002 Hill D9/519
 D472,014 S * 3/2003 Jackel-Marken D28/4
 D512,199 S * 12/2005 Ibanez D1/129
 D516,431 S * 3/2006 Vintro D9/521
 D525,437 S * 7/2006 Leisch et al. D5/53
 D537,563 S * 2/2007 Taniguchi et al. D28/4
 D541,052 S * 4/2007 Miller et al. D5/53

D552,997 S * 10/2007 Blasko D9/521
 D554,529 S * 11/2007 Green et al. D9/726
 D564,900 S * 3/2008 Green et al. D9/715
 D570,219 S * 6/2008 Blasko D9/516
 D579,213 S * 10/2008 Aipa D5/53
 D592,064 S * 5/2009 Kilany D9/519
 D592,512 S * 5/2009 Dubitsky et al. D9/516
 D599,560 S * 9/2009 Sharma D5/59
 D609,107 S * 2/2010 Dubitsky et al. D9/551
 D612,245 S * 3/2010 Canamasas Puigbo D9/519
 D625,469 S * 10/2010 Dubitsky et al. D28/84
 D631,204 S * 1/2011 Dubitsky et al. D28/82
 D644,939 S * 9/2011 Teller D9/726
 8,444,337 B2 * 5/2013 Teller 401/88
 D688,000 S * 8/2013 Johnson et al. D28/4
 D689,366 S * 9/2013 Kohne et al. D9/504
 D695,552 S * 12/2013 Gatto D6/606
 D705,988 S * 5/2014 Scott et al. D28/7
 D708,726 S * 7/2014 Gordon et al. D23/356
 D710,544 S * 8/2014 Shen D28/77
 D715,142 S * 10/2014 Allen et al. D9/434
 D726,028 S * 4/2015 Thompson D9/726

* cited by examiner

FIG. 1

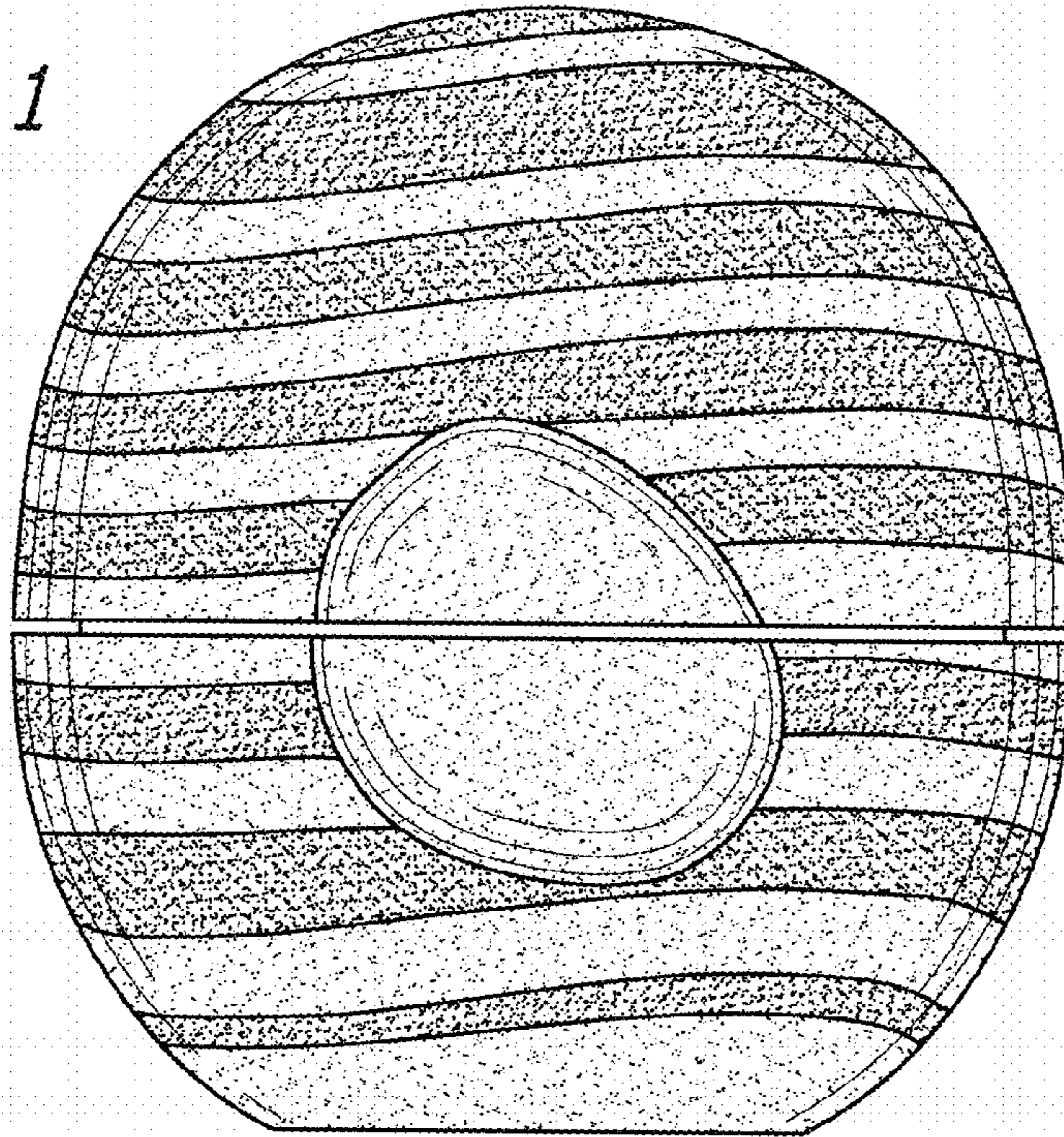

FIG. 2

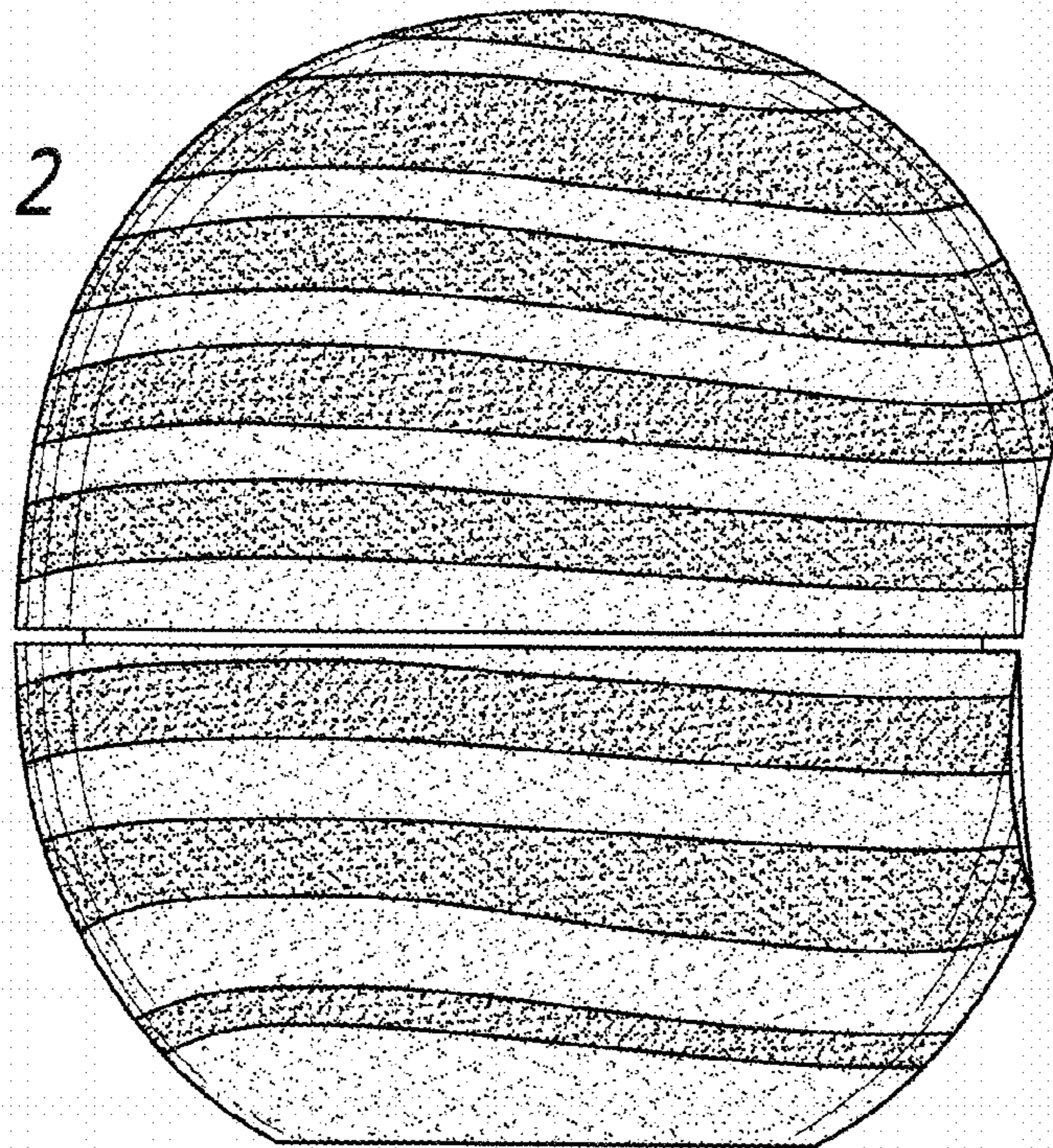

FIG. 3

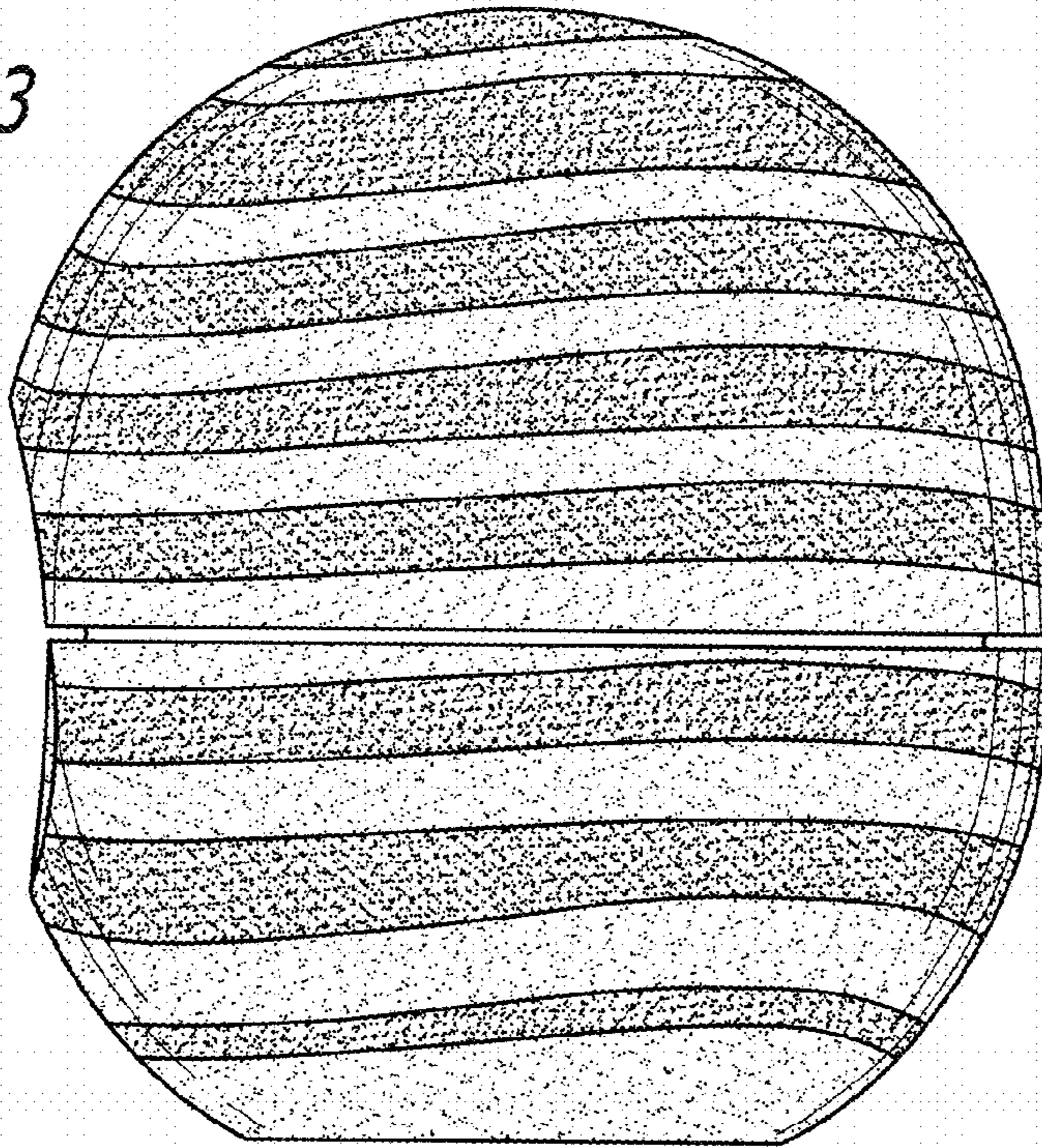

FIG. 4

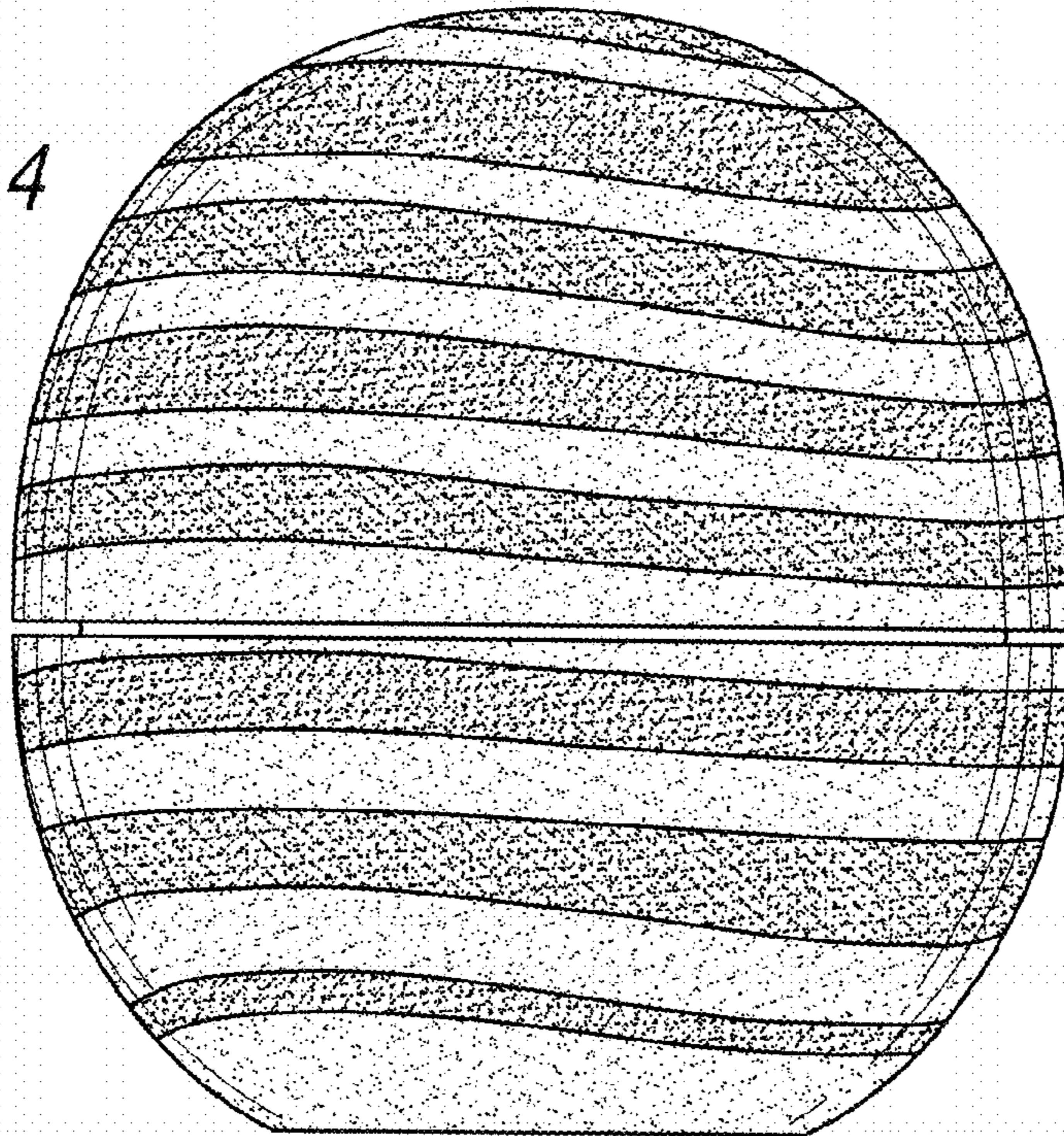

FIG. 5

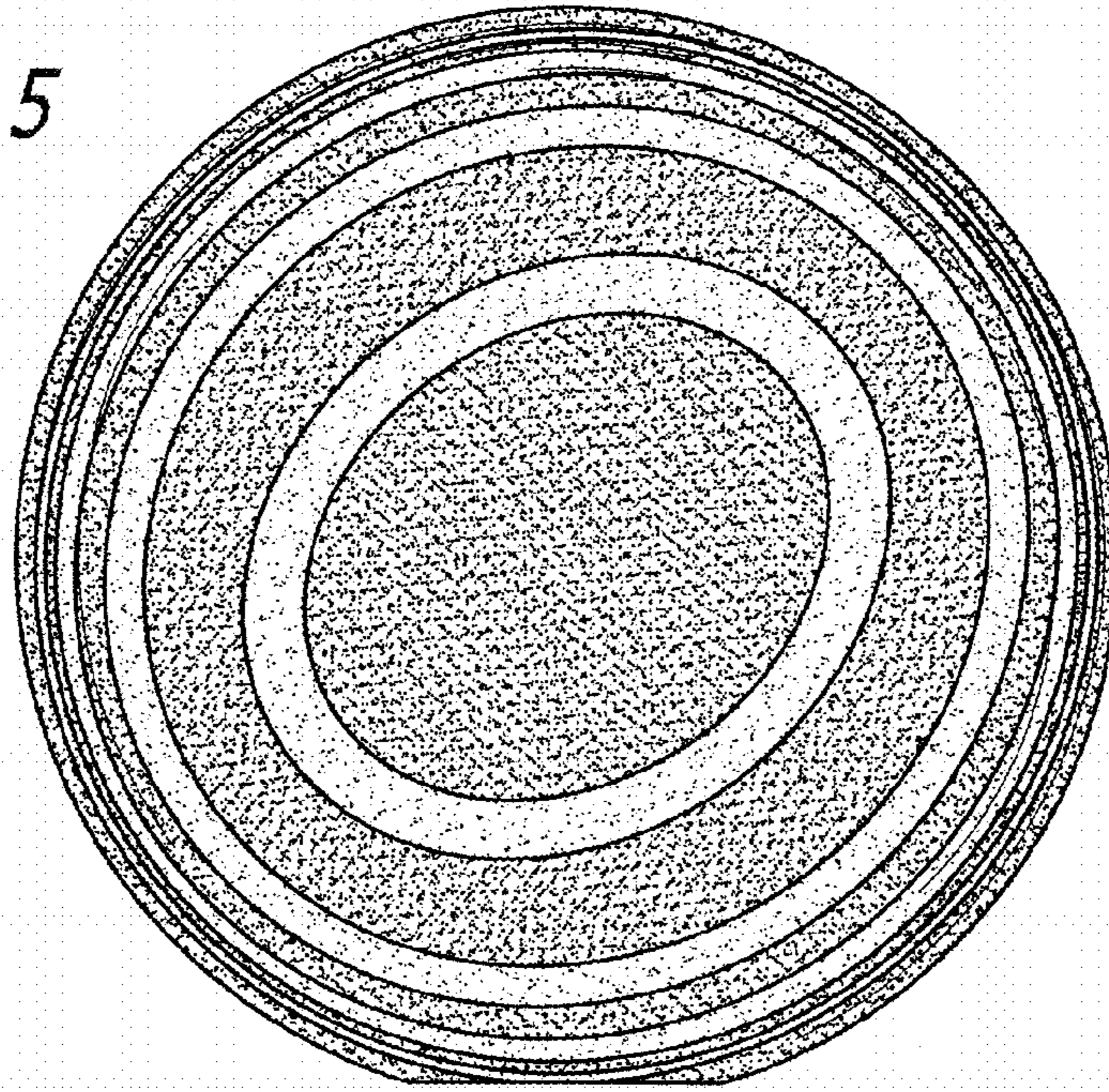

FIG. 6

