



US00D764047S

(12) **United States Design Patent**
Bjelovuk et al.

(10) **Patent No.:** **US D764,047 S**
(45) **Date of Patent:** **** Aug. 16, 2016**

- (54) **THERAPY UNIT ASSEMBLY**
- (71) Applicant: **Smith & Nephew, Inc.**, Memphis, TN (US)
- (72) Inventors: **Brian P. Bjelovuk**, Westerville, OH (US); **Carrie Lee Childress**, Dallas, TX (US); **Kealoha Young Deutsch**, Odessa, FL (US); **William W. Gregory**, Gainesville, FL (US); **Kathryn Ann Leigh**, Saint Petersburg, FL (US); **Andrew P. Muser**, Saint Pete Beach, FL (US); **Felix C. Quintanar**, Hull (GB); **Billy J. Ratliff**, Commerce Township, MI (US); **Michael T. Roller**, Covington, KY (US); **Robert H. Roth**, Cincinnati, OH (US); **Mark Schaefer**, Largo, FL (US)
- (73) Assignee: **Smith & Nephew, Inc.**, Memphis, TN (US)

3,115,138 A 12/1963 McElvenny et al.
 3,295,576 A 1/1967 Schmitt et al.
 D207,194 S 3/1967 Artmann

(Continued)

FOREIGN PATENT DOCUMENTS

CA 2 819 475 6/2012
 DE 1 000 684 1/1957

(Continued)

OTHER PUBLICATIONS

Huntleigh, *WoundAssist TNP Canister*, 6 page Brochure, Huntleigh Healthcare Limited 2007.

(Continued)

Primary Examiner — Barbara Fox
Assistant Examiner — Lilyana Bekic

(74) *Attorney, Agent, or Firm* — Knobbe, Martens, Olson & Bear LLP

(**) Term: **14 Years**

(21) Appl. No.: **29/492,116**

(22) Filed: **May 28, 2014**

(51) **LOC (10) Cl.** **24-01**

(52) **U.S. Cl.**
USPC **D24/108**

(58) **Field of Classification Search**
 USPC D24/107, 108, 111, 188, 185
 CPC . A61M 1/0088; A61M 1/0031; A61M 27/00;
 A61M 1/0023; A61M 1/0001; A61M 1/009;
 A61M 1/0096; A61M 1/0058; A61M 1/0066;
 A61M 1/00

See application file for complete search history.

(56) **References Cited**

U.S. PATENT DOCUMENTS

1,220,957 A 3/1917 Conway
 1,251,404 A 12/1917 Mills
 1,925,694 A 9/1933 Hawkins

(57) **CLAIM**

The ornamental design for a therapy unit assembly, as shown and described.

DESCRIPTION

FIG. 1 is a top, front, and left side perspective view of a therapy unit assembly.
 FIG. 2 is a bottom, rear, and right side perspective view thereof.
 FIG. 3 is a top plan view thereof.
 FIG. 4 is a bottom plan view thereof.
 FIG. 5 is a left side view thereof.
 FIG. 6 is a right side view thereof.
 FIG. 7 is a front view thereof; and,
 FIG. 8 is a rear view thereof.

The broken lines in the drawings illustrate portions of the therapy unit assembly which form no part of the claimed design.

1 Claim, 6 Drawing Sheets

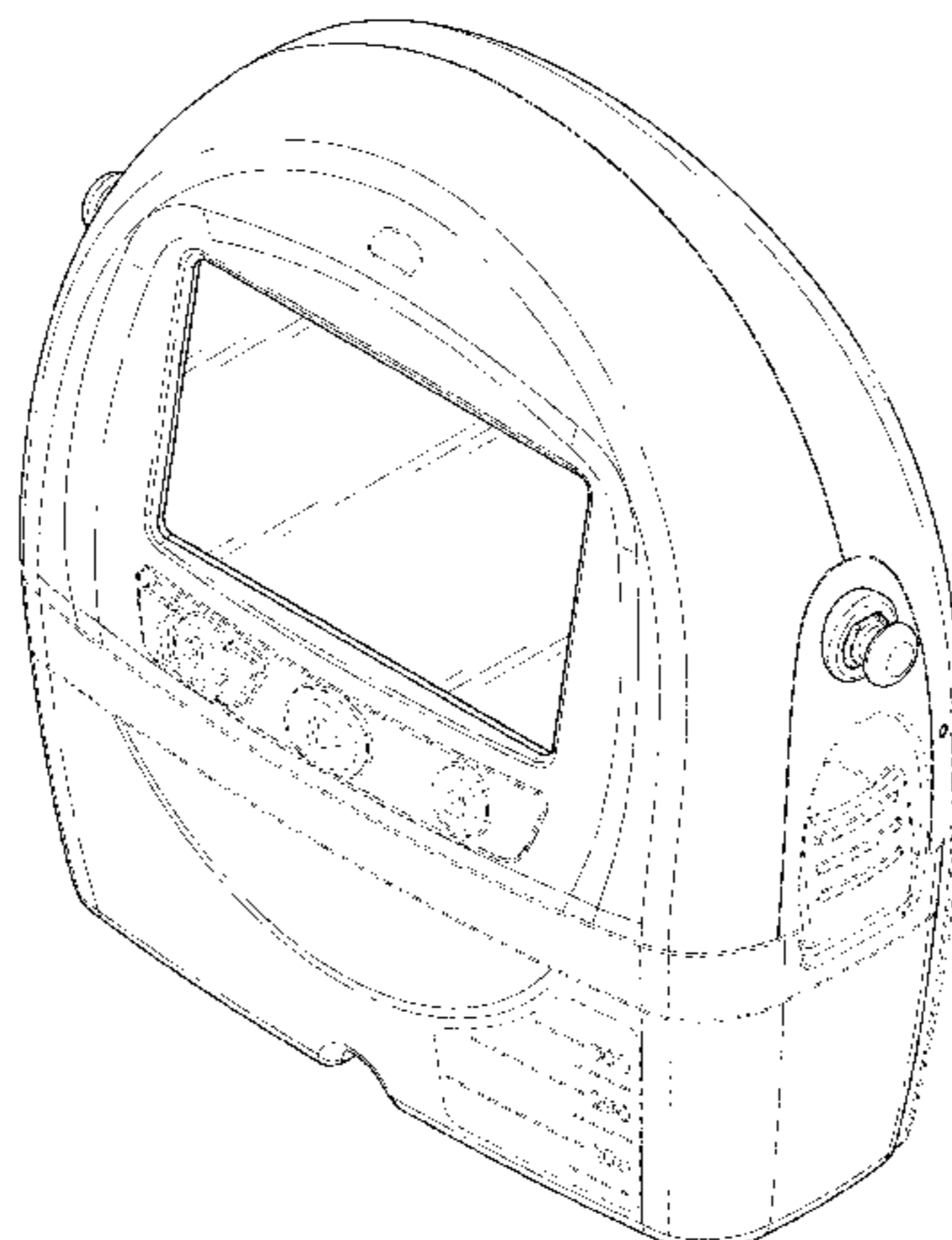

(56)

References Cited

U.S. PATENT DOCUMENTS

D247,068 S	1/1978	Sykes	7,077,832 B2	7/2006	Fleischmann	
4,116,310 A	9/1978	Shields	7,108,683 B2	9/2006	Zamierowski	
D250,225 S	11/1978	Sykes	D537,944 S	3/2007	Eda et al.	
4,382,441 A	5/1983	Svedman	7,195,624 B2	3/2007	Lockwood et al.	
D273,535 S	4/1984	Weinreb	7,198,046 B1	4/2007	Argenta	
4,569,674 A	2/1986	Phillips	7,216,651 B2	5/2007	Argenta et al.	
4,649,973 A	3/1987	Uchin	D543,691 S	6/2007	Payne et al.	
4,655,754 A	4/1987	Richmond et al.	D544,092 S	6/2007	Lewis	
4,710,165 A	12/1987	McNeil et al.	D545,055 S	6/2007	Lieberman et al.	
4,767,417 A	8/1988	Boehringer	D546,952 S	7/2007	May	
4,832,299 A	5/1989	Gorton et al.	D548,347 S	8/2007	Ichino et al.	
4,930,997 A	6/1990	Bennett	D548,954 S	8/2007	Andersen et al.	
4,969,880 A	11/1990	Zamierowski	D551,578 S	9/2007	Kuriger et al.	
5,083,700 A	1/1992	Mello et al.	D556,444 S	12/2007	Ipsen et al.	
D325,126 S	4/1992	Costello	7,317,954 B2	1/2008	McGreevy	
5,134,994 A	8/1992	Say	D565,177 S	3/2008	Locke et al.	
5,176,663 A	1/1993	Svedman et al.	7,438,705 B2	10/2008	Karpowicz et al.	
5,215,523 A	6/1993	Williams et al.	D581,042 S	11/2008	Randolph et al.	
5,219,428 A	6/1993	Stern	D581,521 S *	11/2008	Locke	D24/111
D340,351 S	10/1993	Wrath	D581,522 S	11/2008	Randolph et al.	
5,358,494 A	10/1994	Svedman	D585,135 S	1/2009	Mori et al.	
D352,463 S	11/1994	Kubo	D585,137 S	1/2009	Onoda et al.	
D352,606 S	11/1994	Cylvick et al.	D586,466 S	2/2009	Smith et al.	
5,466,229 A	11/1995	Elson	D587,364 S	2/2009	Pukall et al.	
5,473,536 A	12/1995	Wimmer	D587,376 S	2/2009	Takano et al.	
5,527,293 A	6/1996	Zamierowski	D587,901 S	3/2009	Pidgeon et al.	
5,636,643 A	6/1997	Argenta et al.	D590,934 S	4/2009	Randolph et al.	
D380,607 S	7/1997	Leben	D591,039 S	4/2009	Wung et al.	
5,645,081 A	7/1997	Argenta et al.	7,524,315 B2	4/2009	Blott et al.	
5,687,717 A	11/1997	Halpern et al.	D591,500 S	5/2009	Siegel et al.	
D400,249 S	10/1998	Holubar et al.	7,534,240 B1	5/2009	Johnson	
D406,899 S	3/1999	Cottle	D593,676 S	6/2009	Locke et al.	
D408,625 S	4/1999	Barker	D594,114 S	6/2009	Locke et al.	
5,907,721 A	5/1999	Schelling et al.	D601,692 S *	10/2009	Tout	D24/108
D414,925 S	10/1999	Holland	D602,582 S	10/2009	Pidgeon et al.	
D418,287 S	1/2000	Moor	D602,583 S	10/2009	Pidgeon et al.	
6,010,527 A	1/2000	Augustine et al.	D602,584 S	10/2009	Pidgeon et al.	
D423,102 S	4/2000	Mertenant	D607,202 S	1/2010	Pidgeon et al.	
6,071,267 A	6/2000	Zamierowski	7,678,090 B2	3/2010	Risk, Jr.	
D434,150 S	11/2000	Tumey et al.	7,694,814 B1	4/2010	Cristobal et al.	
6,142,982 A	11/2000	Hunt et al.	D617,094 S	6/2010	Pidgeon et al.	
D436,443 S	1/2001	Hillman	D617,461 S	6/2010	Kaushal et al.	
D439,341 S	3/2001	Tumey et al.	D625,801 S	10/2010	Pidgeon et al.	
6,279,804 B1	8/2001	Gregg	D630,313 S	1/2011	Pidgeon et al.	
D447,336 S	9/2001	Bergkvist et al.	D630,725 S	1/2011	Pidgeon et al.	
D449,891 S	10/2001	Moro	D635,588 S	4/2011	Sprules	
D456,514 S	4/2002	Brown et al.	D642,594 S	8/2011	Mattson et al.	
6,390,345 B1	5/2002	Brown et al.	D644,250 S	8/2011	Barber et al.	
6,398,767 B1	6/2002	Fleischmann	8,007,481 B2	8/2011	Schuessler et al.	
6,468,199 B1	10/2002	Satou et al.	D645,137 S	9/2011	Gonzalez	
D469,175 S	1/2003	Hall et al.	8,048,046 B2	11/2011	Hudspeth et al.	
D469,176 S	1/2003	Hall et al.	D650,894 S	12/2011	Gonzalez	
D471,274 S *	3/2003	Diaz	8,100,873 B2	1/2012	Jaeb et al.	
D471,361 S	3/2003	Crandall	D654,095 S	2/2012	Mattson et al.	
D475,132 S	5/2003	Randolph	D654,164 S *	2/2012	Cole	D24/108
D477,869 S	7/2003	Vijfvinkel	D660,409 S *	5/2012	Taggerty	D24/108
D478,659 S	8/2003	Hall et al.	D661,188 S	6/2012	Fahy	
D481,459 S	10/2003	Nahm	D661,189 S	6/2012	Fahy	
6,648,862 B2	11/2003	Watson	D661,190 S	6/2012	Fahy	
D486,517 S	2/2004	Hendee	8,202,262 B2	6/2012	Lina et al.	
6,738,052 B1	5/2004	Manke et al.	8,216,198 B2	7/2012	Heagle et al.	
6,752,794 B2	6/2004	Lockwood et al.	8,240,470 B2	8/2012	Pidgeon et al.	
6,755,807 B2	6/2004	Risk et al.	8,287,736 B2	10/2012	Roncadi et al.	
6,764,462 B2	7/2004	Risk, Jr. et al.	8,317,752 B2	11/2012	Cozmi et al.	
6,824,533 B2	11/2004	Risk, Jr. et al.	D672,141 S	12/2012	Harbinson	
D502,802 S	3/2005	Fair	D675,728 S	2/2013	Tout et al.	
D504,953 S	5/2005	Ryan	D681,806 S	5/2013	Kataoka et al.	
D505,543 S	5/2005	Miller	D682,546 S	5/2013	Nicolini	
6,936,037 B2	8/2005	Bubb et al.	D684,365 S	6/2013	Leblanc	
6,948,614 B1	9/2005	Hall et al.	8,494,349 B2	7/2013	Gordon	
6,957,738 B2	10/2005	Hammond	8,552,880 B2	10/2013	Kopp et al.	
D516,217 S	2/2006	Brown et al.	8,577,692 B2	11/2013	Silkaitis et al.	
7,004,915 B2	2/2006	Boynton et al.	8,801,686 B2	8/2014	Bendele et al.	
7,022,113 B2	4/2006	Lockwood et al.	D726,302 S	4/2015	Hanna	
D522,657 S	6/2006	Murphy et al.	2002/0198503 A1	12/2002	Risk, Jr. et al.	
			2003/0050594 A1	3/2003	Zamierowski	
			2005/0177190 A1	8/2005	Zamierowski	
			2005/0247732 A1	11/2005	Ouke	
			2006/0289329 A1	12/2006	Miller	

(56)

References Cited

FOREIGN PATENT DOCUMENTS

U.S. PATENT DOCUMENTS

2007/0038172 A1 2/2007 Zamierowski
 2007/0131573 A1 6/2007 Boyles
 2007/0193902 A1 8/2007 Myers et al.
 2007/0250009 A1 10/2007 Barak
 2007/0260226 A1* 11/2007 Jaeb A61M 1/0005
 604/543
 2008/0033400 A1 2/2008 Holper et al.
 2008/0071234 A1 3/2008 Kelch et al.
 2008/0200905 A1 8/2008 Heaton
 2008/0272254 A1 11/2008 Harr et al.
 2009/0012482 A1 1/2009 Pinto
 2009/0043268 A1* 2/2009 Eddy A61M 1/0037
 604/290
 2009/0076467 A1 3/2009 Pinto
 2009/0125055 A1 5/2009 Larkin et al.
 2009/0221990 A1* 9/2009 Jaeb A61M 1/0001
 604/540
 2009/0254066 A1 10/2009 Heaton
 2009/0270820 A1 10/2009 Johnson
 2009/0299306 A1* 12/2009 Buan A61M 1/0027
 604/319
 2010/0022990 A1 1/2010 Karpowicz et al.
 2010/0036333 A1 2/2010 Schenk, III et al.
 2010/0187065 A1 7/2010 Pidgeon et al.
 2010/0191199 A1* 7/2010 Evans A61M 1/0001
 604/319
 2010/0207768 A1 8/2010 Pidgeon et al.
 2010/0286638 A1 11/2010 Malhi
 2011/0038741 A1* 2/2011 Lissner F04B 37/10
 417/313
 2011/0066110 A1 3/2011 Fathallah et al.
 2011/0077605 A1 3/2011 Karpowicz et al.
 2011/0190703 A1 8/2011 Pratt et al.
 2011/0290979 A1 12/2011 Henault et al.
 2012/0123323 A1 5/2012 Kagan et al.
 2012/0181405 A1 7/2012 Zlatic et al.
 2012/0271256 A1 10/2012 Locke et al.
 2012/0302979 A1* 11/2012 Locke A61M 1/0088
 604/319
 2013/0066301 A1 3/2013 Locke et al.
 2013/0110058 A1* 5/2013 Adie A61M 1/0031
 604/319
 2013/0310809 A1 11/2013 Armstrong et al.
 2014/0309600 A1* 10/2014 Aceto A61M 1/0088
 604/318
 2015/0190288 A1* 7/2015 Dunn A61F 13/00068
 604/319

DE 20301859 6/2003
 DE 10 2010 03640 1/2012
 EP 0 777 504 B1 10/1998
 EP 2 319 476 5/2011
 EP 1 565 219 B1 2/2014
 GB 2 037 150 7/1980
 GB 1 575 266 9/1980
 GB 2 195 255 4/1988
 GB 2307180 5/1997
 WO WO 90/11795 10/1990
 WO WO 91/00718 1/1991
 WO WO 92/20299 11/1992
 WO WO 96/05873 2/1996
 WO WO 03/074106 9/2003
 WO WO 2004/037334 5/2004
 WO WO 2005/006975 1/2005
 WO WO 2005/105180 1/2005
 WO WO 2007/013064 2/2007
 WO WO 2007/024230 3/2007
 WO WO 2007/030599 3/2007
 WO WO 2008/036344 3/2008
 WO WO 2009/151645 12/2009
 WO WO 2010/017484 2/2010
 WO WO 2010/039481 4/2010
 WO WO 2013/126049 8/2013
 WO WO 2014/151930 9/2014
 WO WO 2015/091070 6/2015

OTHER PUBLICATIONS

International Search Report and Written Opinion for International Application No. PCT/US2014/026692, Notification mailed Mar. 2, 2015.
 Medela: Invia Motion, Negative Pressure Wound Therapy System, Clinical Instructions for Use, 76 pages. Medela AB/200.4168/2012-11/A.
 Molnlycke IFU Solo Pump—Patient Instructions for Use, issued 2013-05/200.6006/A, 448096 rev 04. 121 pages.
 Specification and drawings as filed in U.S. Appl. No. 29/492,114 on May 28, 2014.
 Specification and drawings as filed in U.S. Appl. No. 29/492,729 on Jun. 2, 2014.
 Specification and drawings as filed in U.S. Appl. No. 29/492,728 on Jun. 2, 2014.
 Specification and drawings as filed in U.S. Appl. No. 29/492,724 on Jun. 2, 2014.
 Specification and drawings as filed in U.S. Appl. No. 29/492,121 on May 28, 2014.

* cited by examiner

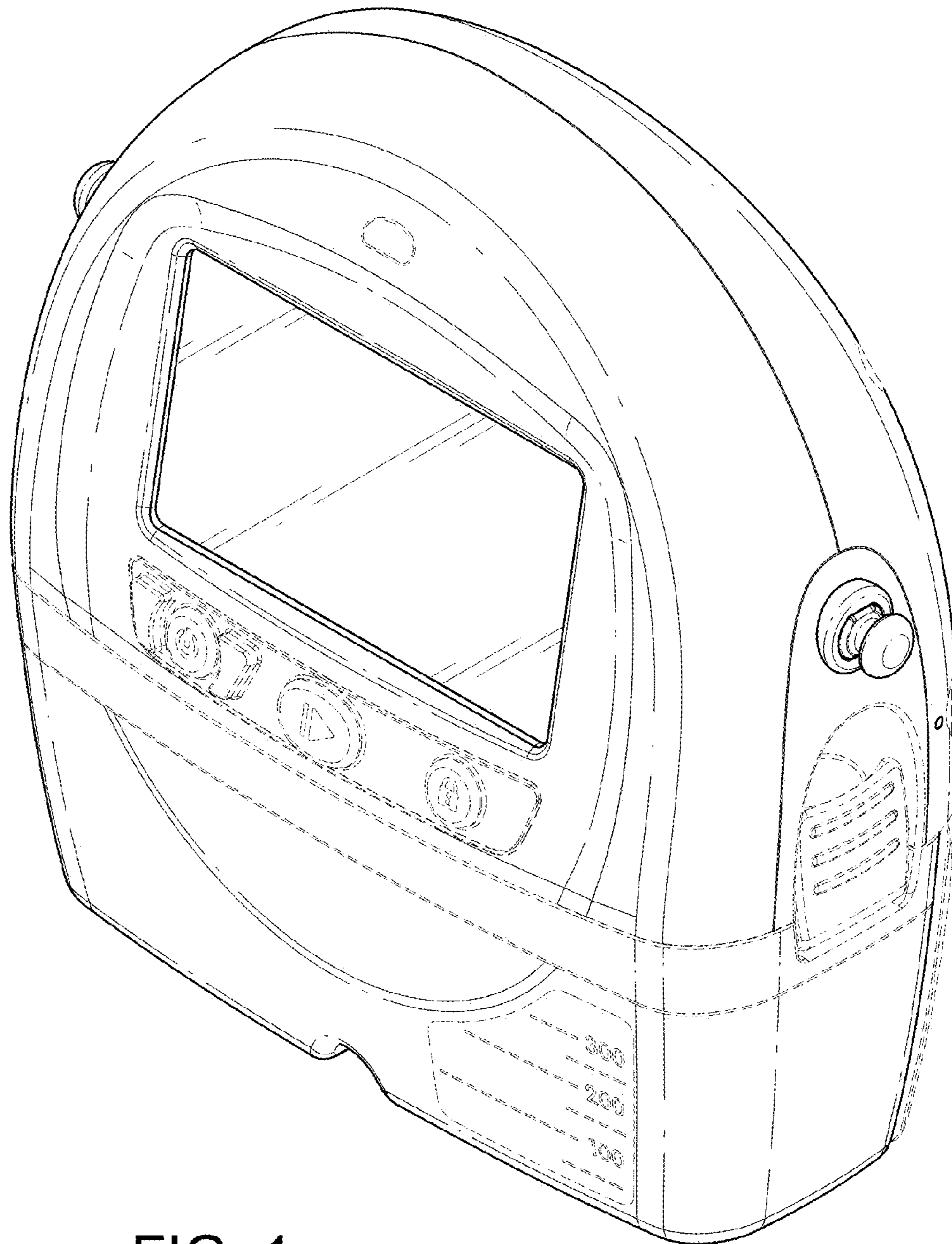

FIG. 1

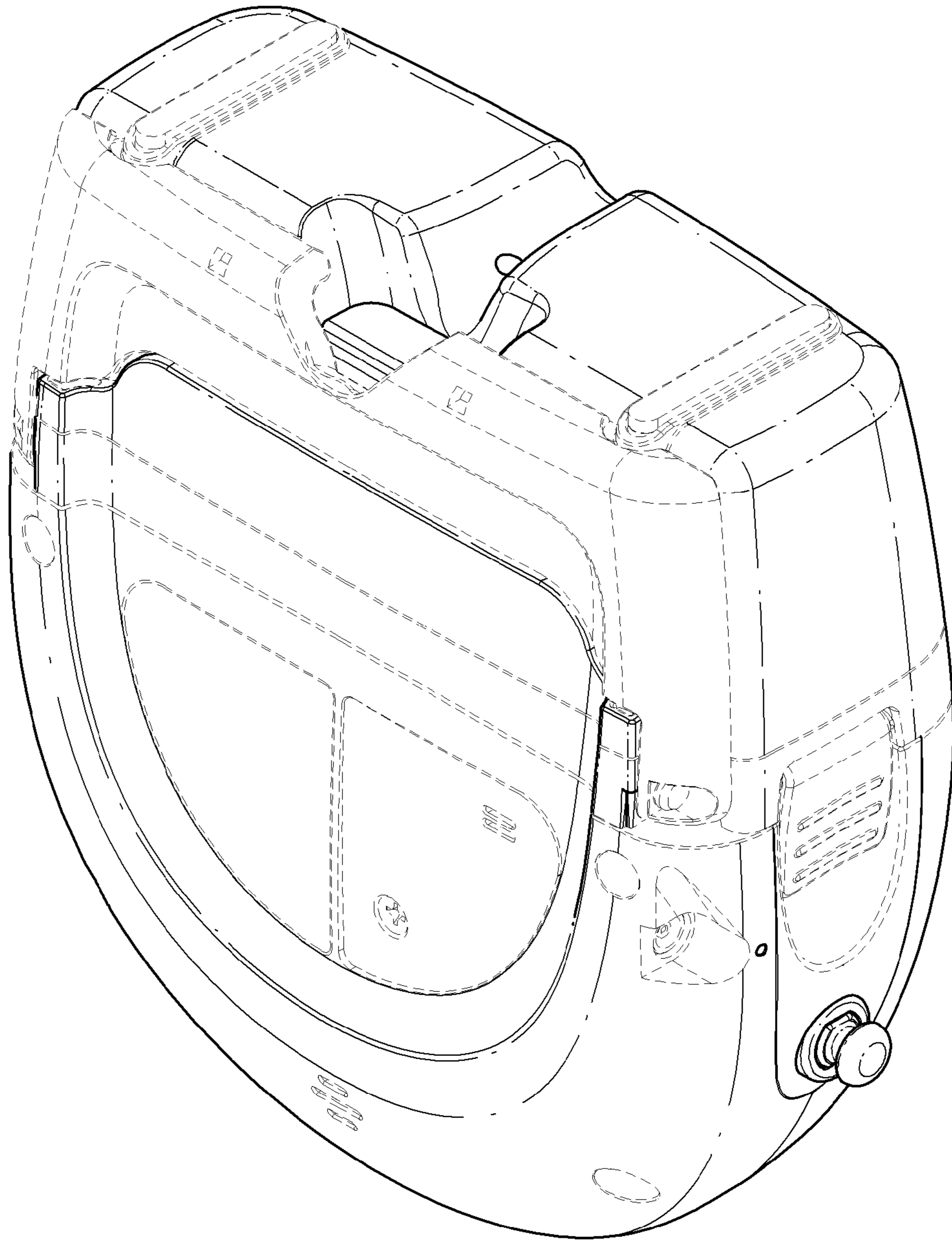

FIG. 2

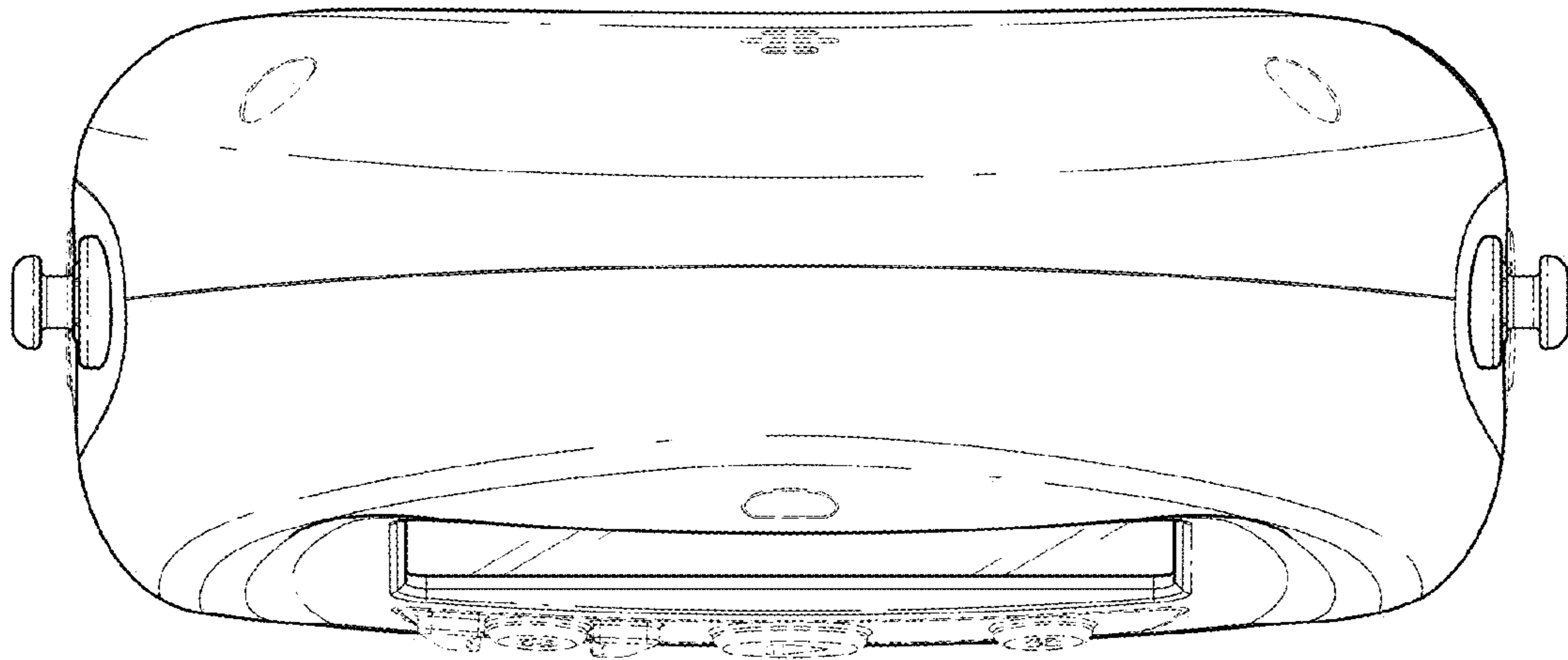

FIG. 3

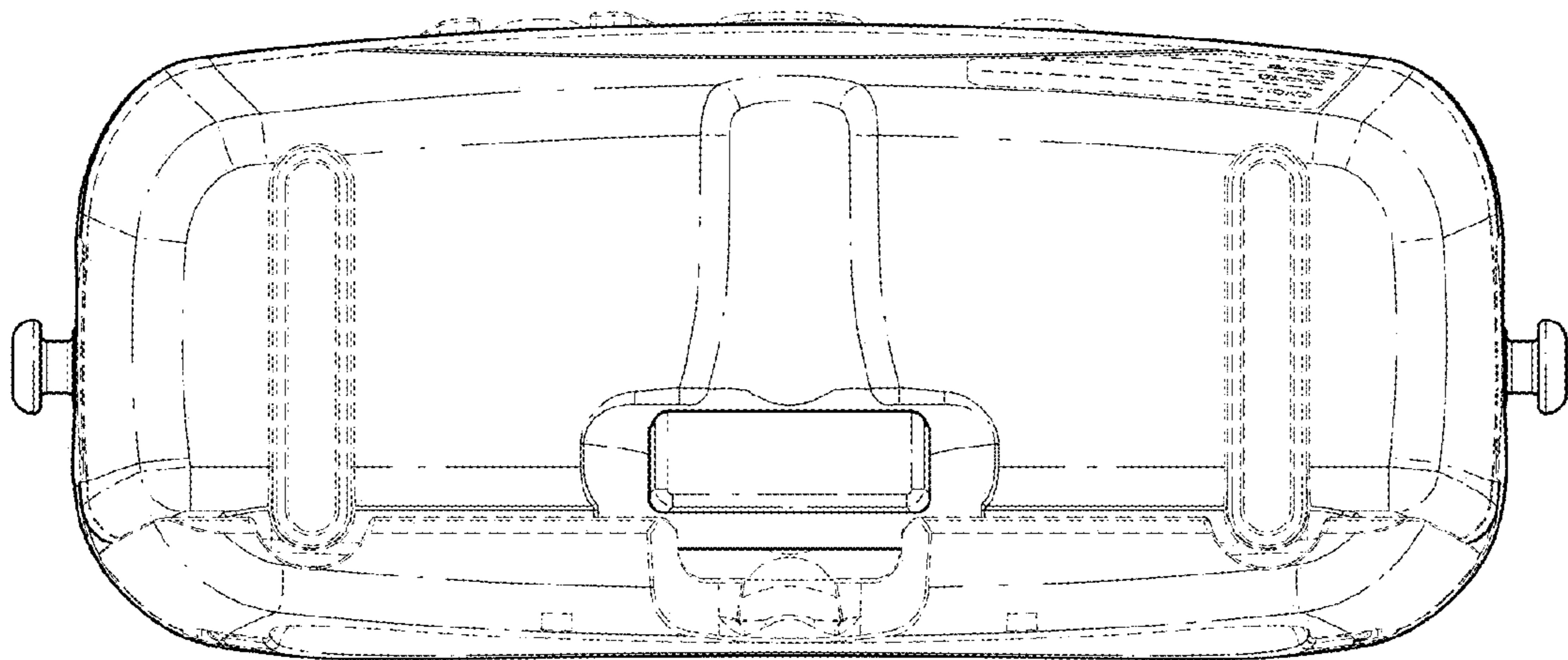

FIG. 4

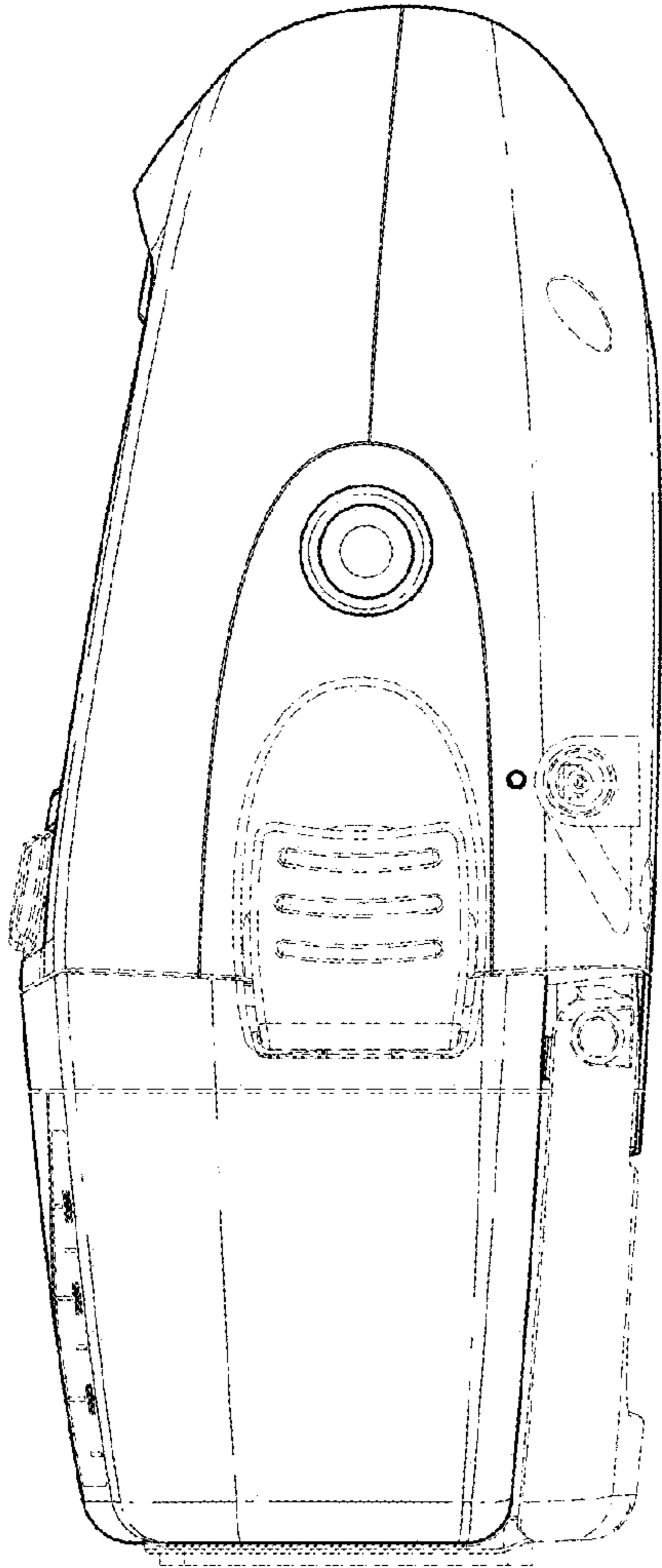

FIG. 5

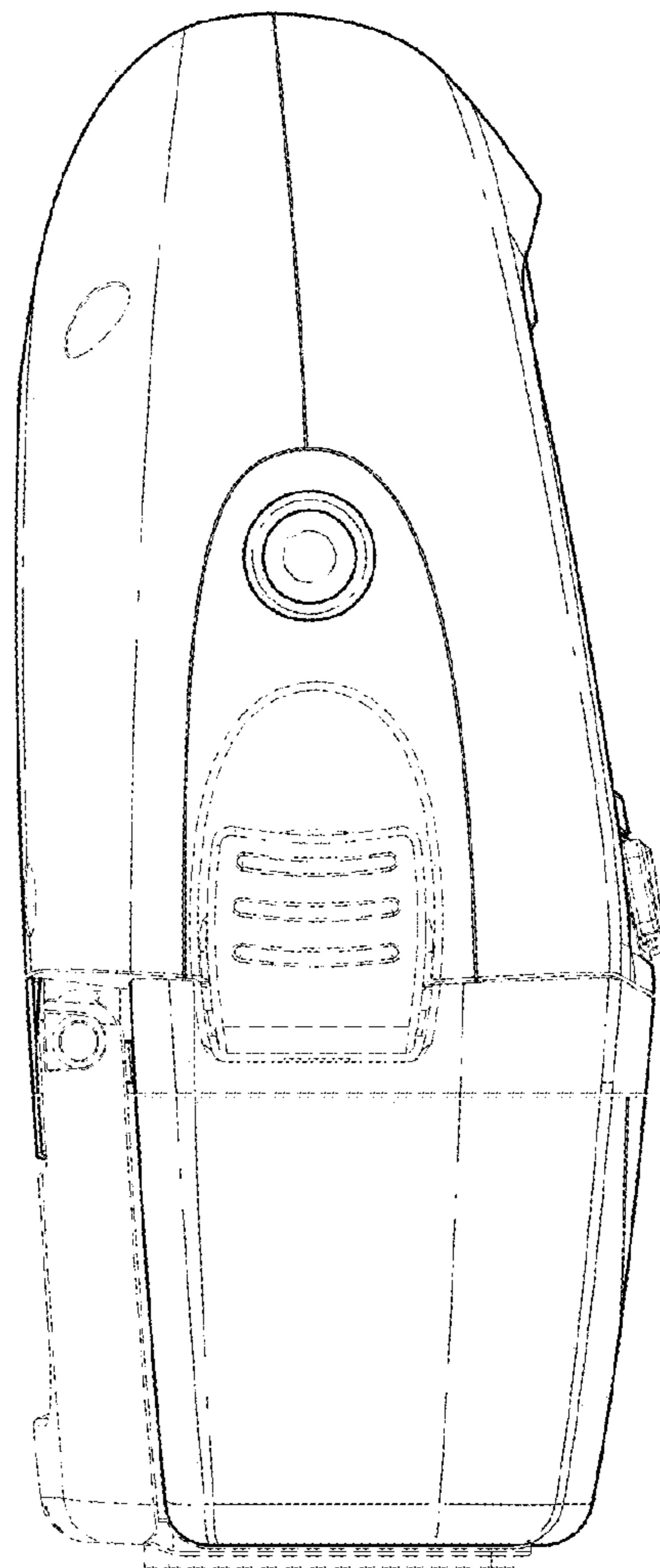

FIG. 6

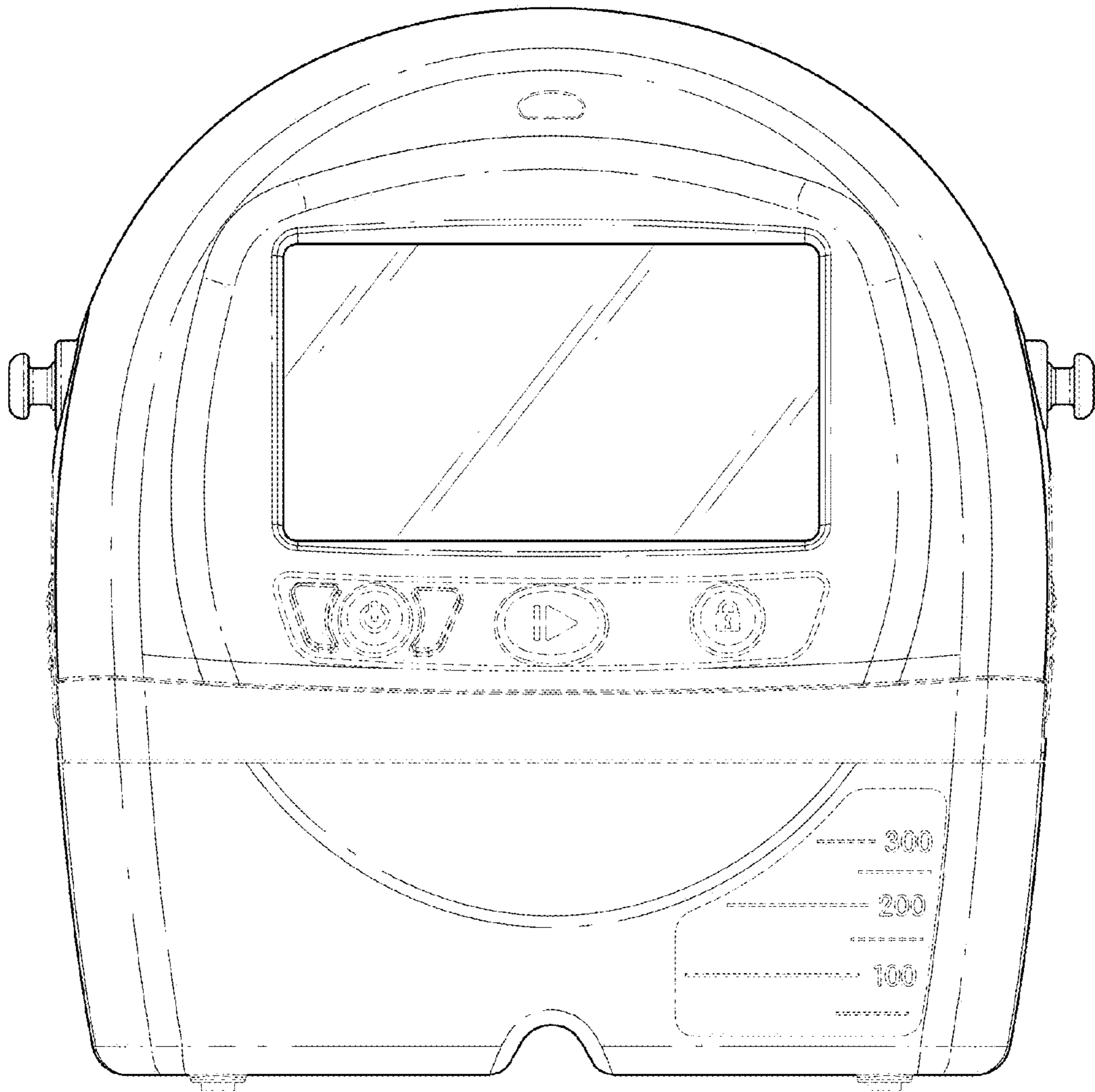

FIG. 7

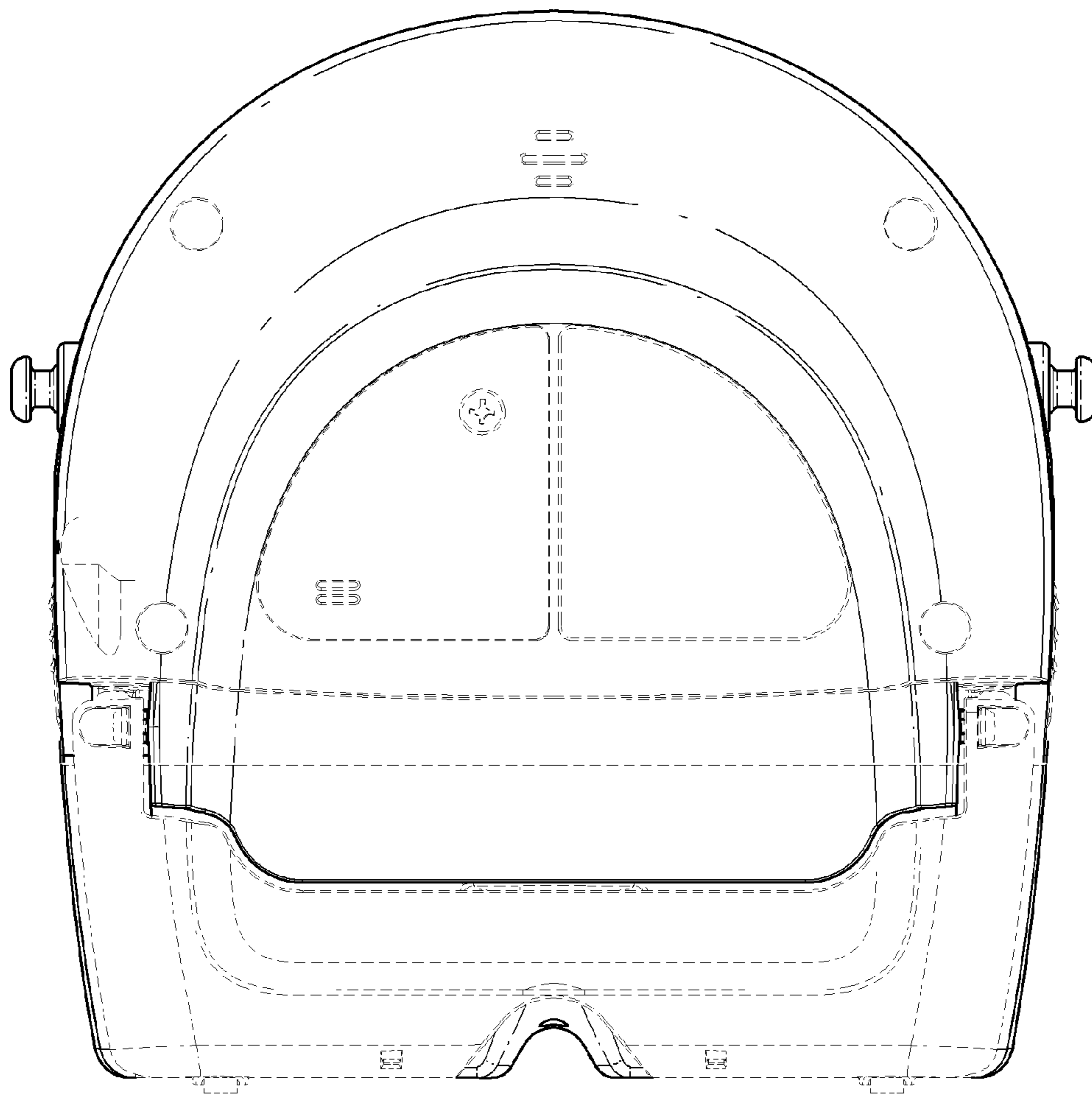

FIG. 8