



US00D763983S

(12) **United States Design Patent**
Tang et al.

(10) **Patent No.:** **US D763,983 S**

(45) **Date of Patent:** **** Aug. 16, 2016**

(54) **GOLF CLUB HEAD**

(71) Applicant: **CALLAWAY GOLF COMPANY,**
Carlsbad, CA (US)

(72) Inventors: **Larry G. Tang,** Carlsbad, CA (US);
Scott R. Manwaring, Carlsbad, CA
(US)

(73) Assignee: **Callaway Golf Company,** Carlsbad, CA
(US)

(**) Term: **15 Years**

(21) Appl. No.: **29/529,782**

(22) Filed: **Jun. 10, 2015**

(51) **LOC (10) Cl.** **21-02**

(52) **U.S. Cl.**
USPC **D21/752**

(58) **Field of Classification Search**
USPC D21/747-751, 752, 759
CPC A63B 53/04; A63B 53/0466; A63B
2053/002; A63B 2053/0445; A63B
2053/0433; A63B 2053/0437; A63B
2053/0491

See application file for complete search history.

(56) **References Cited**

U.S. PATENT DOCUMENTS

D307,783 S * 5/1990 Iinuma D21/752
D350,176 S * 8/1994 Antonious D21/752

D363,750 S * 10/1995 Reed D21/752
D402,726 S * 12/1998 McCabe D21/733
D425,953 S * 5/2000 Glod D21/759
D437,018 S * 1/2001 Leysock D21/752
D462,101 S * 8/2002 Debenon D21/752
D469,141 S * 1/2003 Poynor D21/759
D523,502 S * 6/2006 Jorgensen D21/752
D571,882 S * 6/2008 Soracco D21/752
D591,810 S * 5/2009 Murphy D21/752
D591,816 S * 5/2009 Vehse D21/752
D614,711 S * 4/2010 Harbert D21/752
D622,337 S * 8/2010 Kohno D21/752

* cited by examiner

Primary Examiner — Mitchell Siegel

(74) *Attorney, Agent, or Firm* — Rebecca Hanovice;
Michael Catania; Sonia Lari

(57) **CLAIM**

The ornamental design for a golf club head, as shown and described.

DESCRIPTION

FIG. 1 is a rear perspective view of the golf club head as claimed herein;

FIG. 2 is a front elevational view thereof;

FIG. 3 is a rear elevational view thereof;

FIG. 4 is a left side elevational view thereof;

FIG. 5 is a right side elevational view thereof;

FIG. 6 is a top perspective view thereof; and,

FIG. 7 is a bottom perspective view thereof.

The broken lines are included for the purpose of illustration only and form no part of the claimed design.

1 Claim, 4 Drawing Sheets

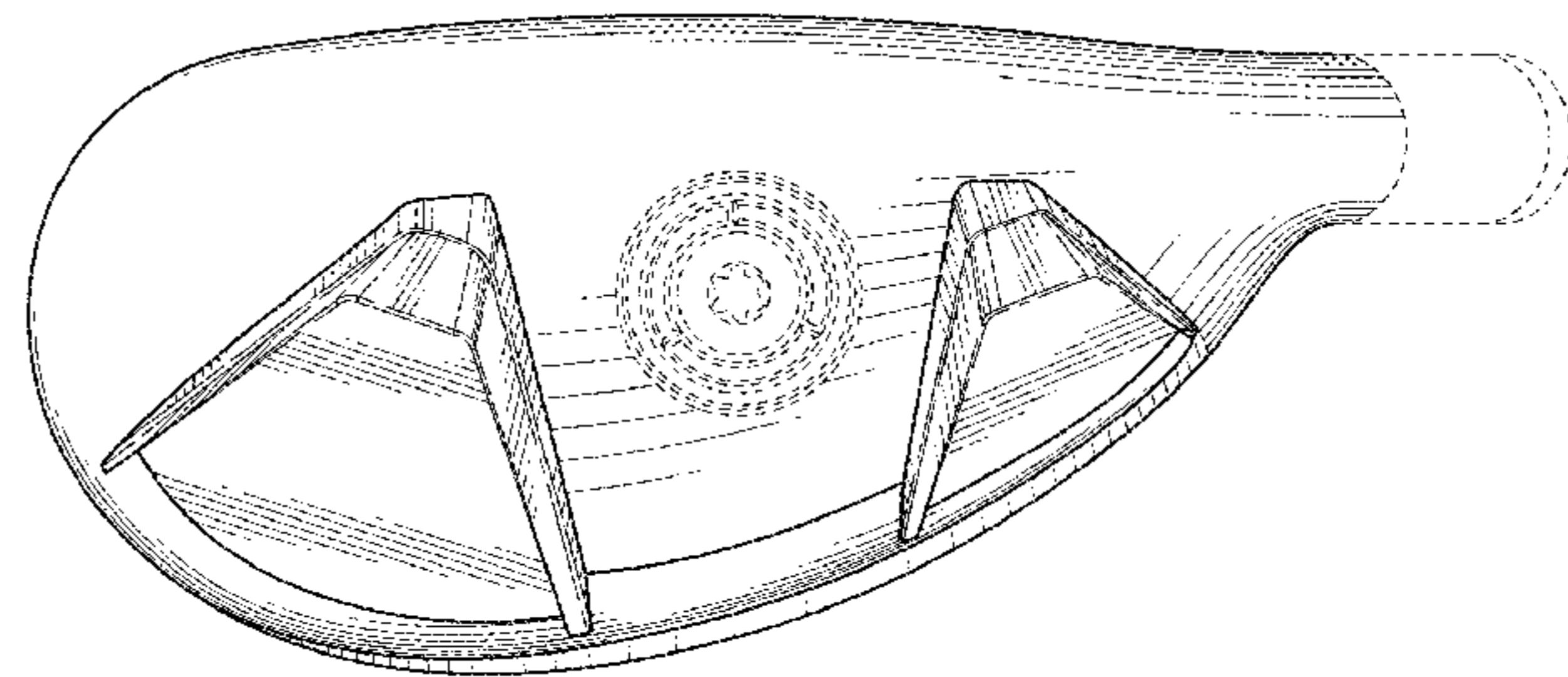
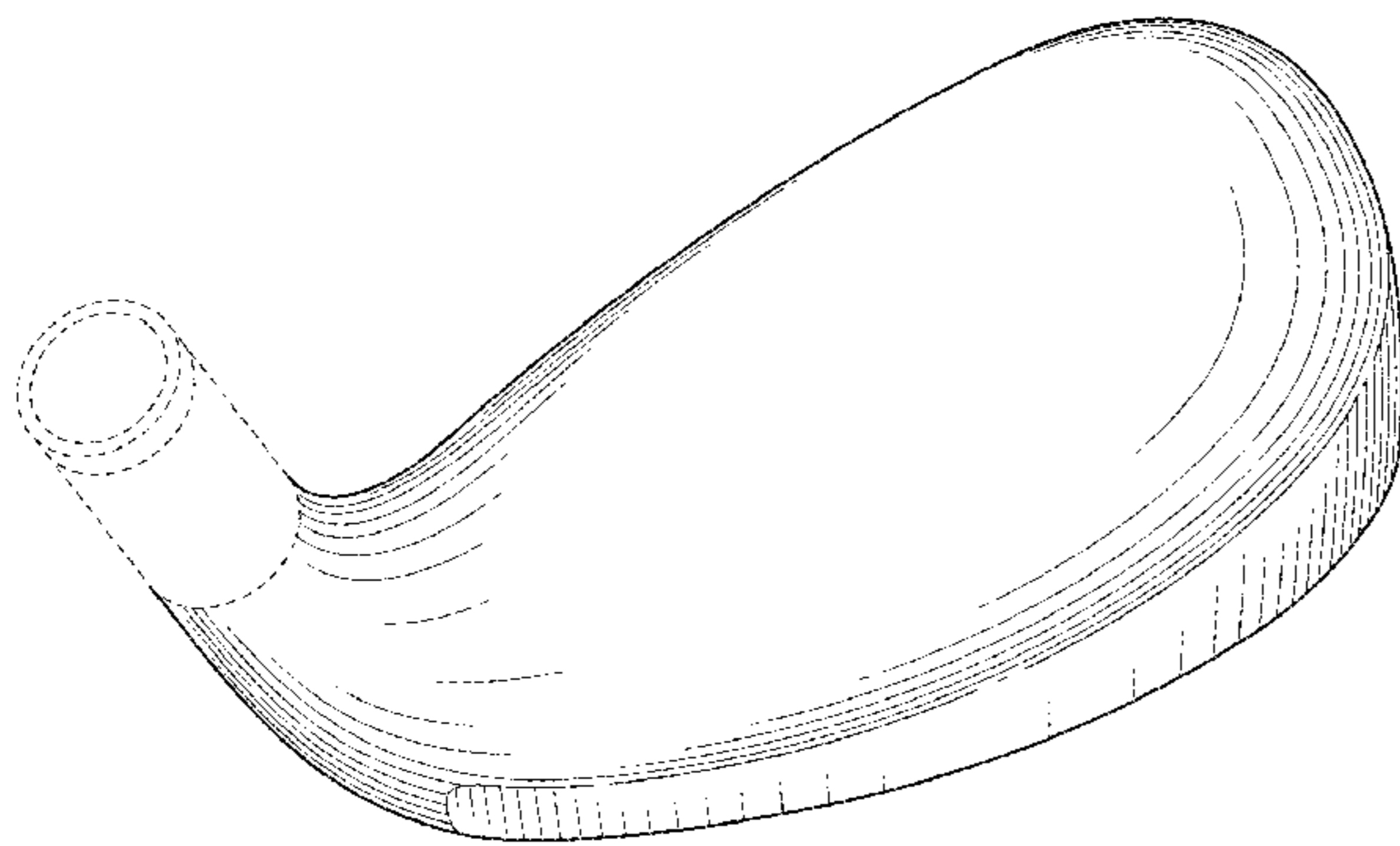

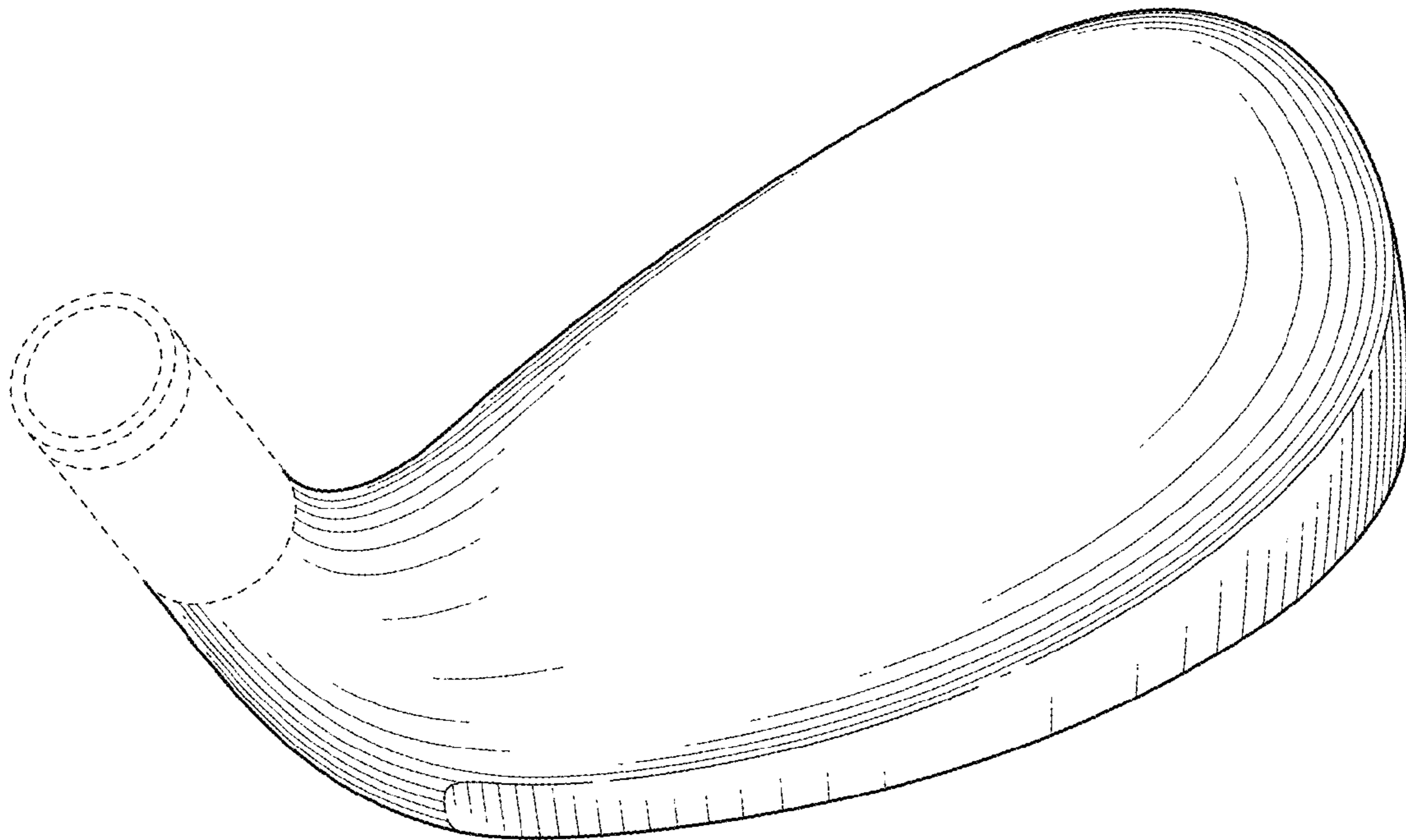

FIG. 1

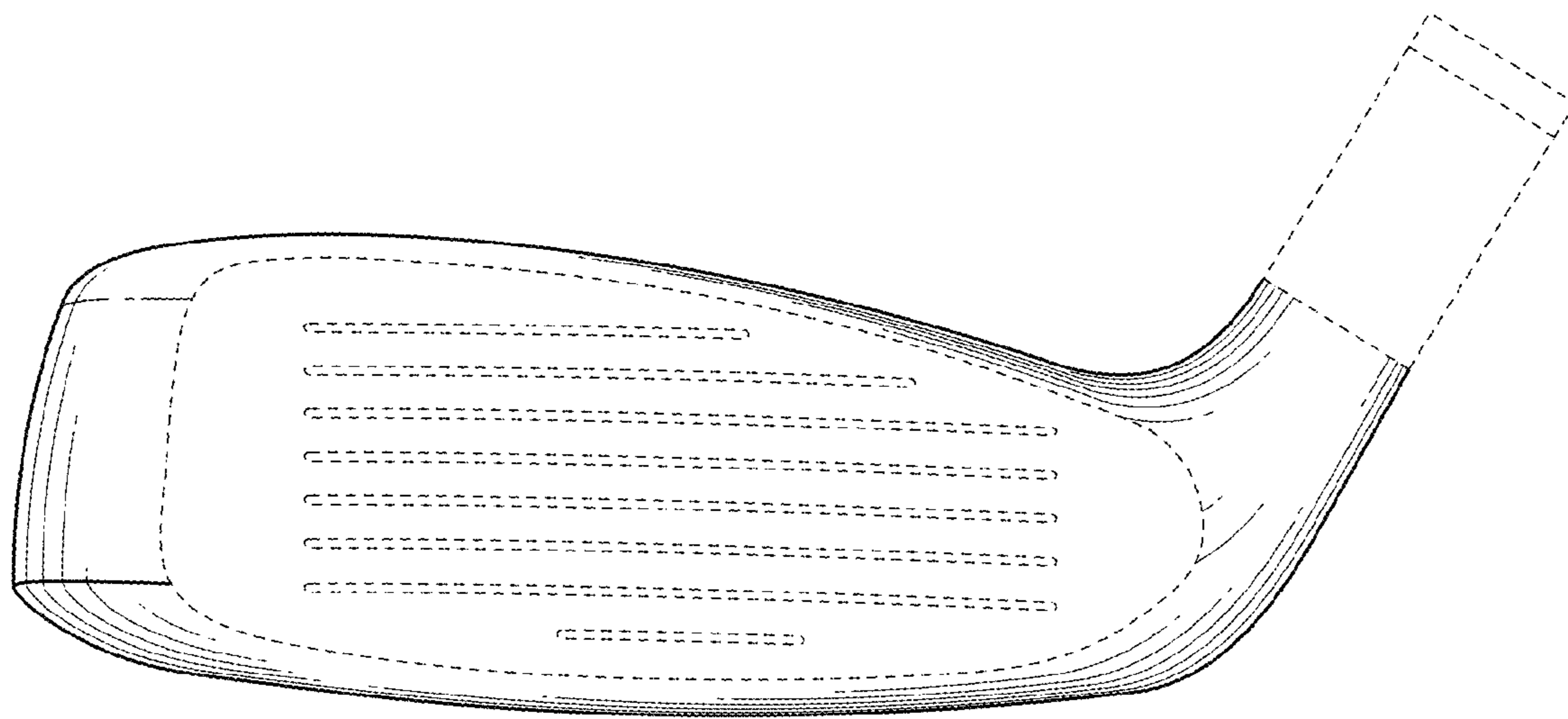

FIG. 2

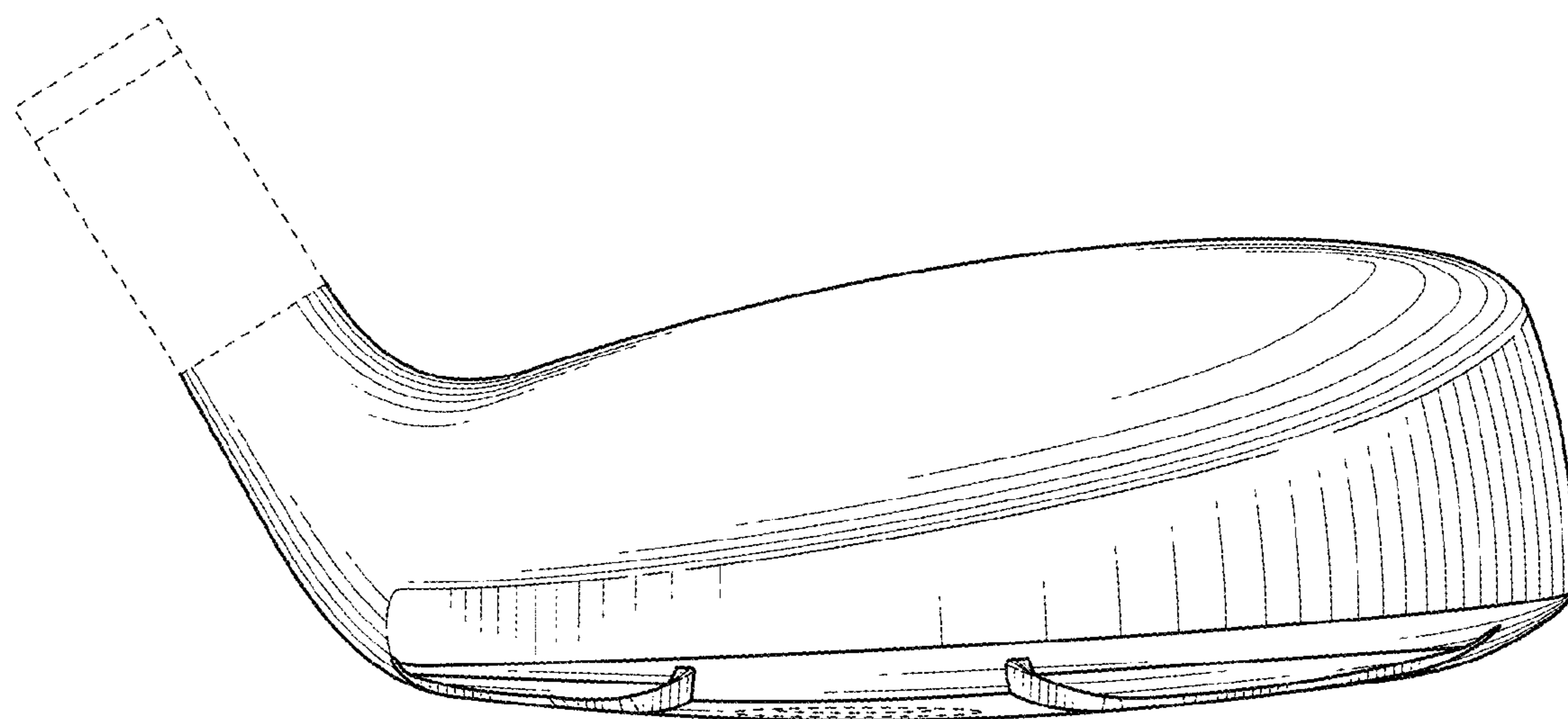

FIG. 3

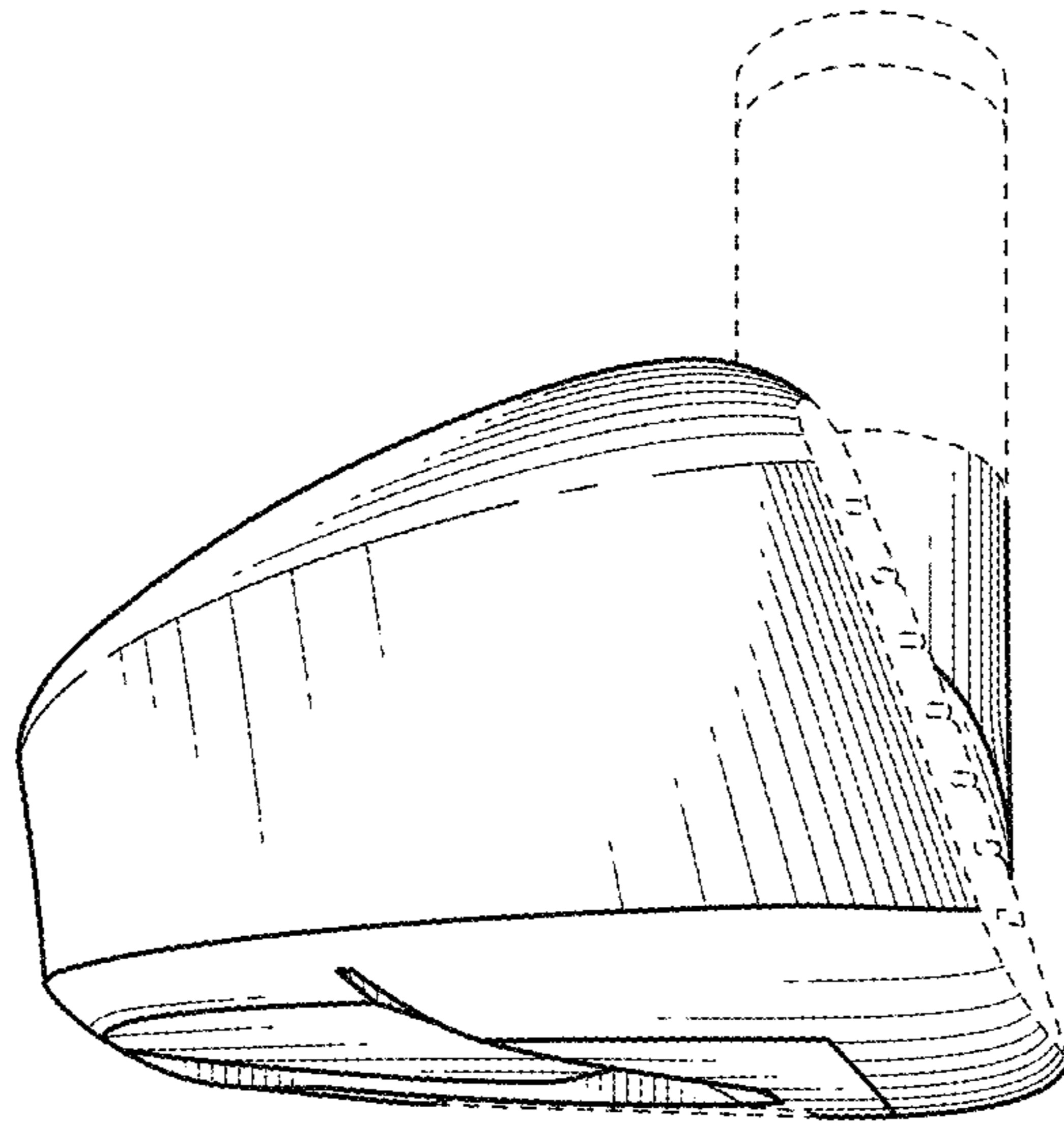

FIG. 4

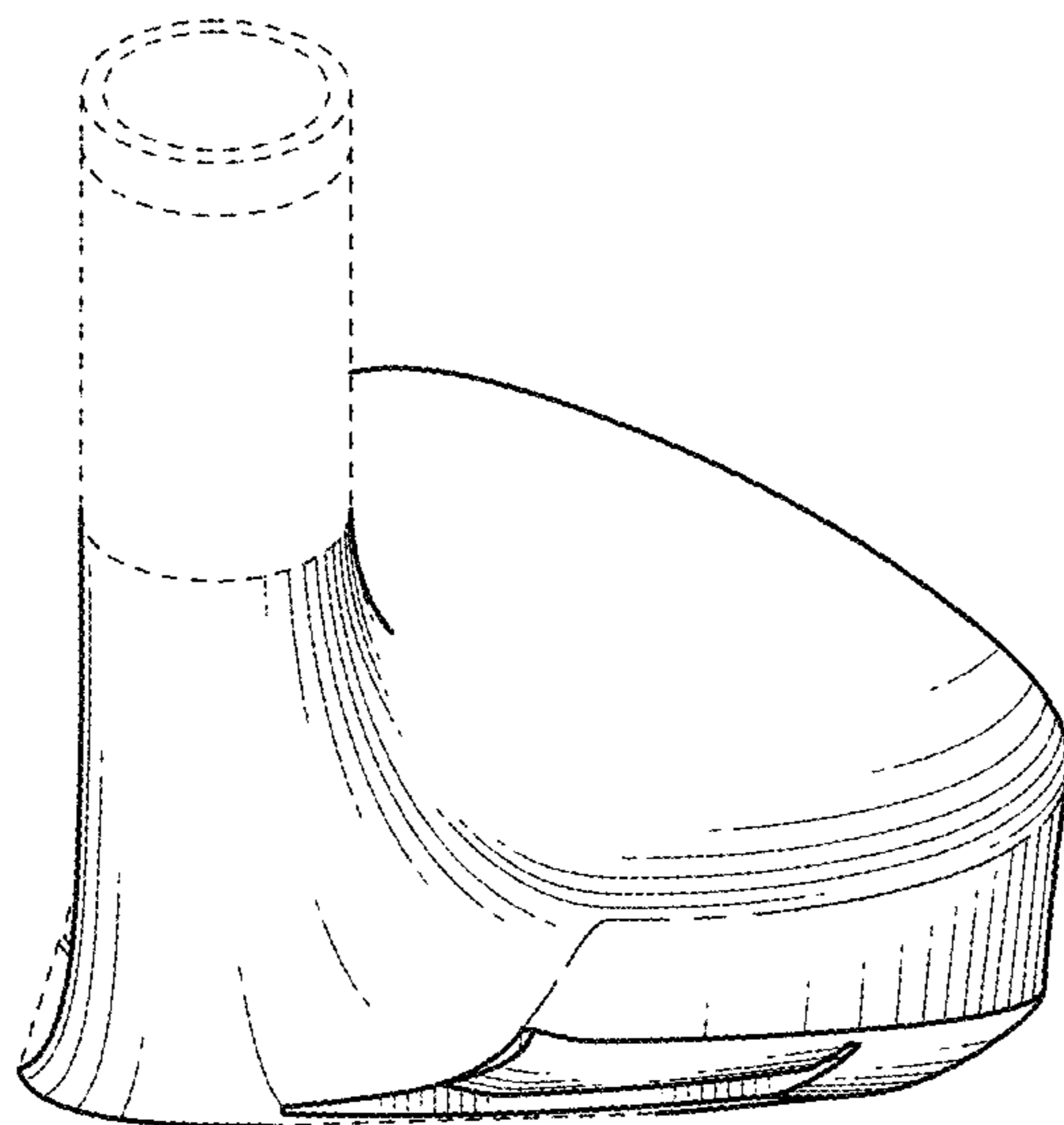

FIG. 5

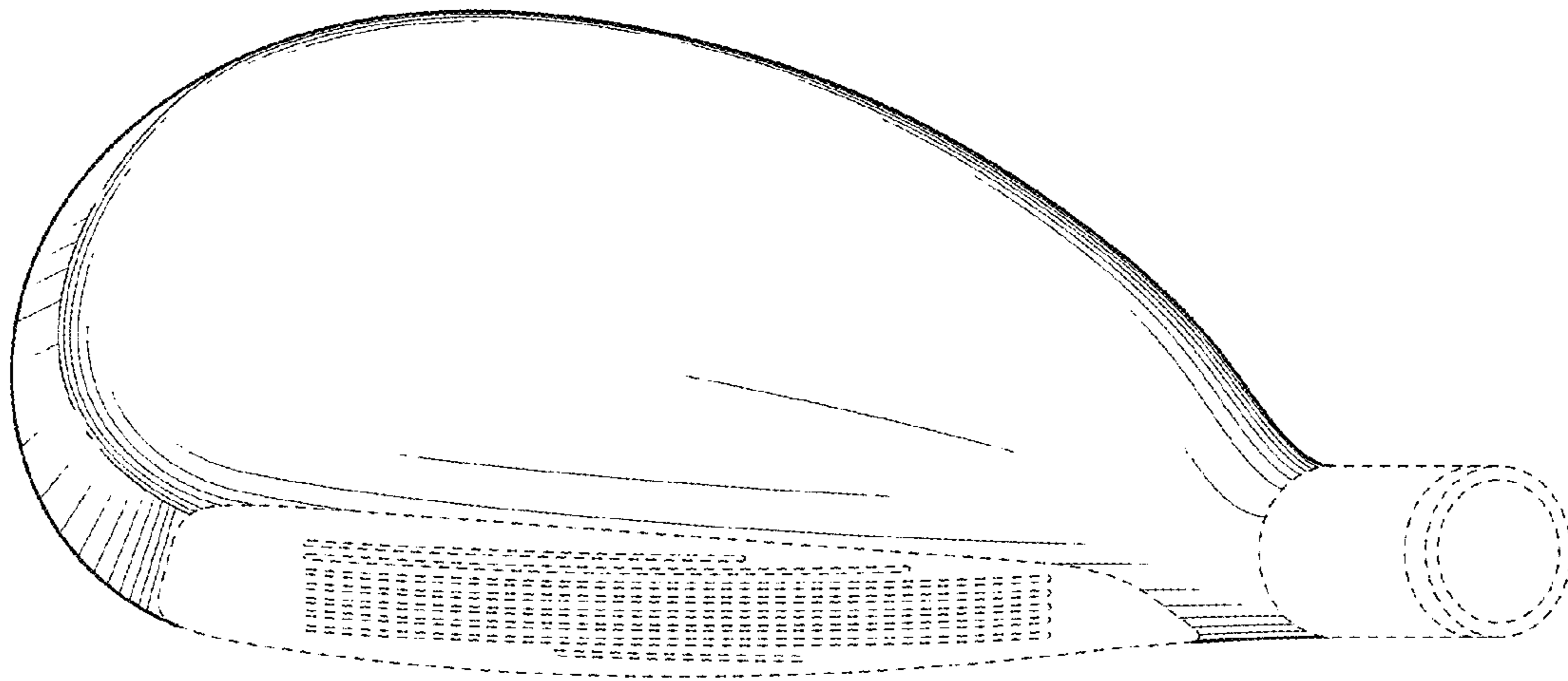

FIG. 6

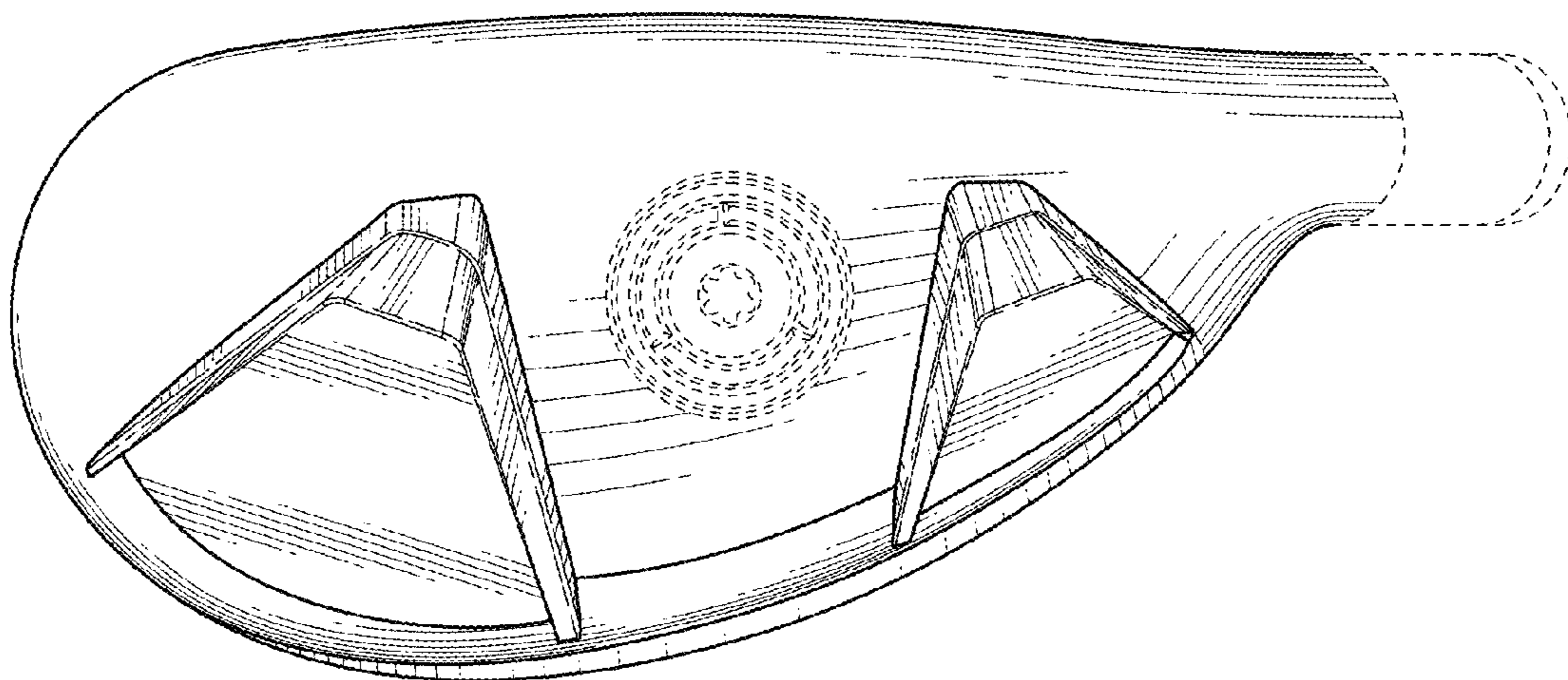

FIG. 7