



US00D763859S

(12) **United States Design Patent**
Wang

(10) **Patent No.:** **US D763,859 S**

(45) **Date of Patent:** **** Aug. 16, 2016**

(54) **STAND FOR DISPLAY**

2021/0335; H02G 3/126; F16B 47/00; F16B 47/006; A47G 1/17; A47K 2201/00

See application file for complete search history.

(71) Applicant: **AmTRAN Technology Co., Ltd.**, New Taipei (TW)

(56) **References Cited**

(72) Inventor: **Kuan-Hua Wang**, New Taipei (TW)

U.S. PATENT DOCUMENTS

(73) Assignee: **AmTRAN Technology Co., Ltd.**, New Taipei (TW)

D655,266	S	*	3/2012	Kim	D14/126
D658,615	S	*	5/2012	Chiu	D14/126
D716,776	S	*	11/2014	Yoon	D14/239
D717,753	S	*	11/2014	Totsuka	D14/126
D719,119	S	*	12/2014	Park	D14/126
D719,142	S	*	12/2014	Lee	D14/239
D722,989	S	*	2/2015	Park	D14/126
D738,336	S	*	9/2015	Hwangbo	D14/126
D741,829	S	*	10/2015	McManigal	D14/126
D743,385	S	*	11/2015	Ann	D14/239
D745,496	S	*	12/2015	Gao	D14/239
D750,035	S	*	2/2016	Jiang	D14/126
D750,584	S	*	3/2016	Lee	D14/126

(**) Term: **14 Years**

(21) Appl. No.: **29/514,545**

(22) Filed: **Jan. 14, 2015**

(30) **Foreign Application Priority Data**

Sep. 17, 2014 (TW) 103305461

(51) **LOC (10) Cl.** **08-07**

(52) **U.S. Cl.**
USPC **D14/451**

(58) **Field of Classification Search**
USPC D14/371-382, 125-129, 336, 337, D14/447-452, 492, 335, 239, 457, 439-441, D14/432, 251-253; D8/349, 354, 363, 373, D8/376, 380; D21/333; D12/415; D3/218; 348/180, 184, 325, 739, 825

CPC . G06F 3/0412; G06F 1/13338; G06F 3/3648; G06F 3/016; G06F 3/0488; G06F 3/011; G06F 3/038; G06F 3/03543; G06F 3/0338; G06F 3/0202; G06F 3/0219; G06F 3/0213; G06F 1/1616; G06F 3/023; G06F 3/04883; G02F 1/1313; G02F 1/1333; G02F 1/135; G02F 1/132; G02F 1/133308; G02F 1/134309; G02F 1/13718; G03F 7/70291; G06K 15/1252; B41J 2/465; G02B 27/0172; G02B 5/30; G02B 2027/0118; G02B 27/0101; F16M 13/02; F16M 13/00; F16M 11/10; F16M 11/04; F16M 2200/08; F16M 11/2021; A47B 21/0314; A47B 88/044; A47B

* cited by examiner

Primary Examiner — Garth Rademaker

Assistant Examiner — Katie S Mroczka

(74) *Attorney, Agent, or Firm* — CKC & Partners Co., Ltd.

(57) **CLAIM**

The ornamental design for a stand for display, as shown and described.

DESCRIPTION

FIG. 1 is a perspective view of a stand for display showing my new design;
FIG. 2 is a front view thereof;
FIG. 3 is a rear view thereof;
FIG. 4 is a left side view thereof;
FIG. 5 is a right side view thereof;
FIG. 6 is a top view thereof; and,
FIG. 7 is a bottom view thereof.
The broken lines in FIGS. 1-7 illustrate the environment of the stand for display and form no part thereof.

1 Claim, 7 Drawing Sheets

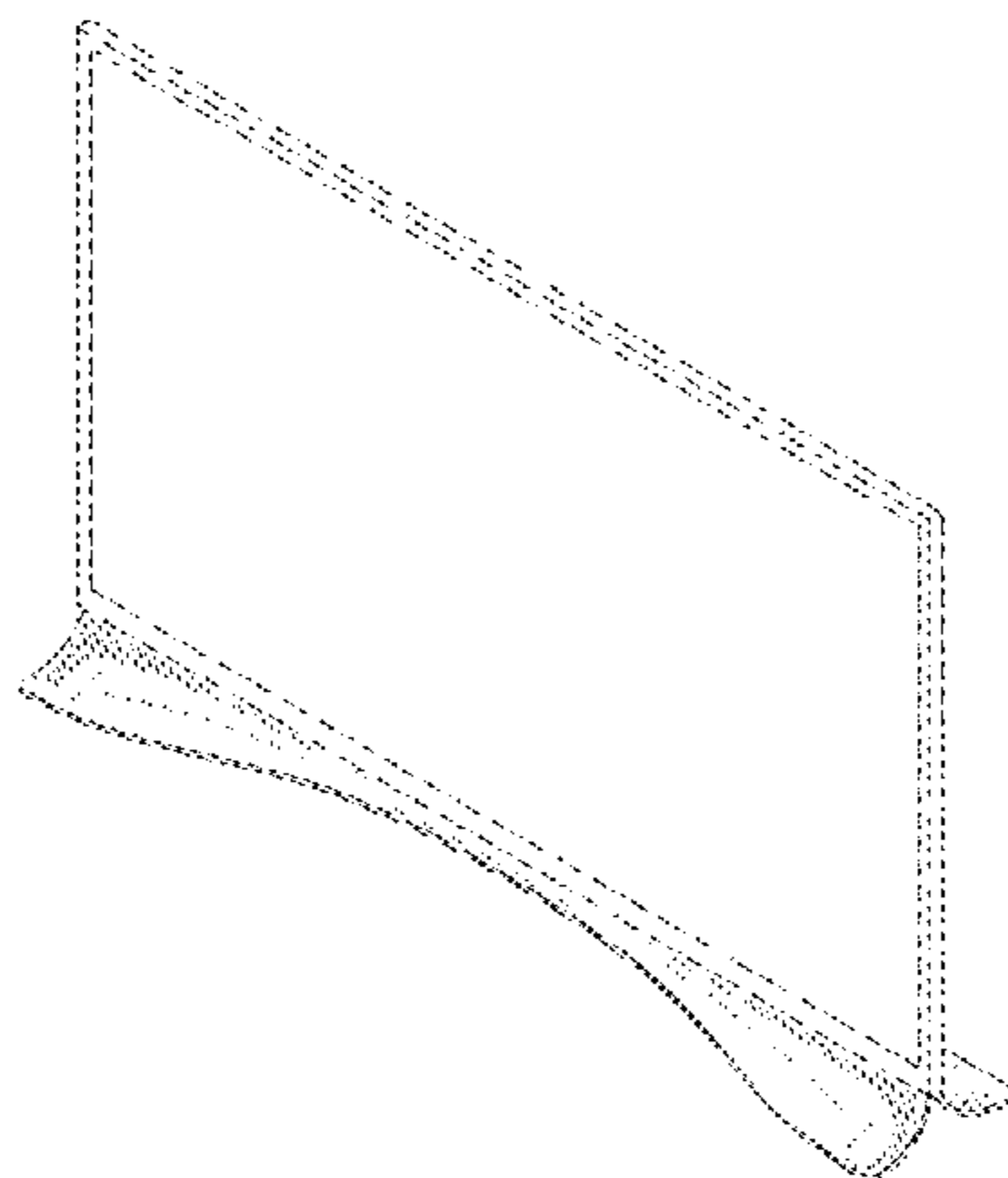

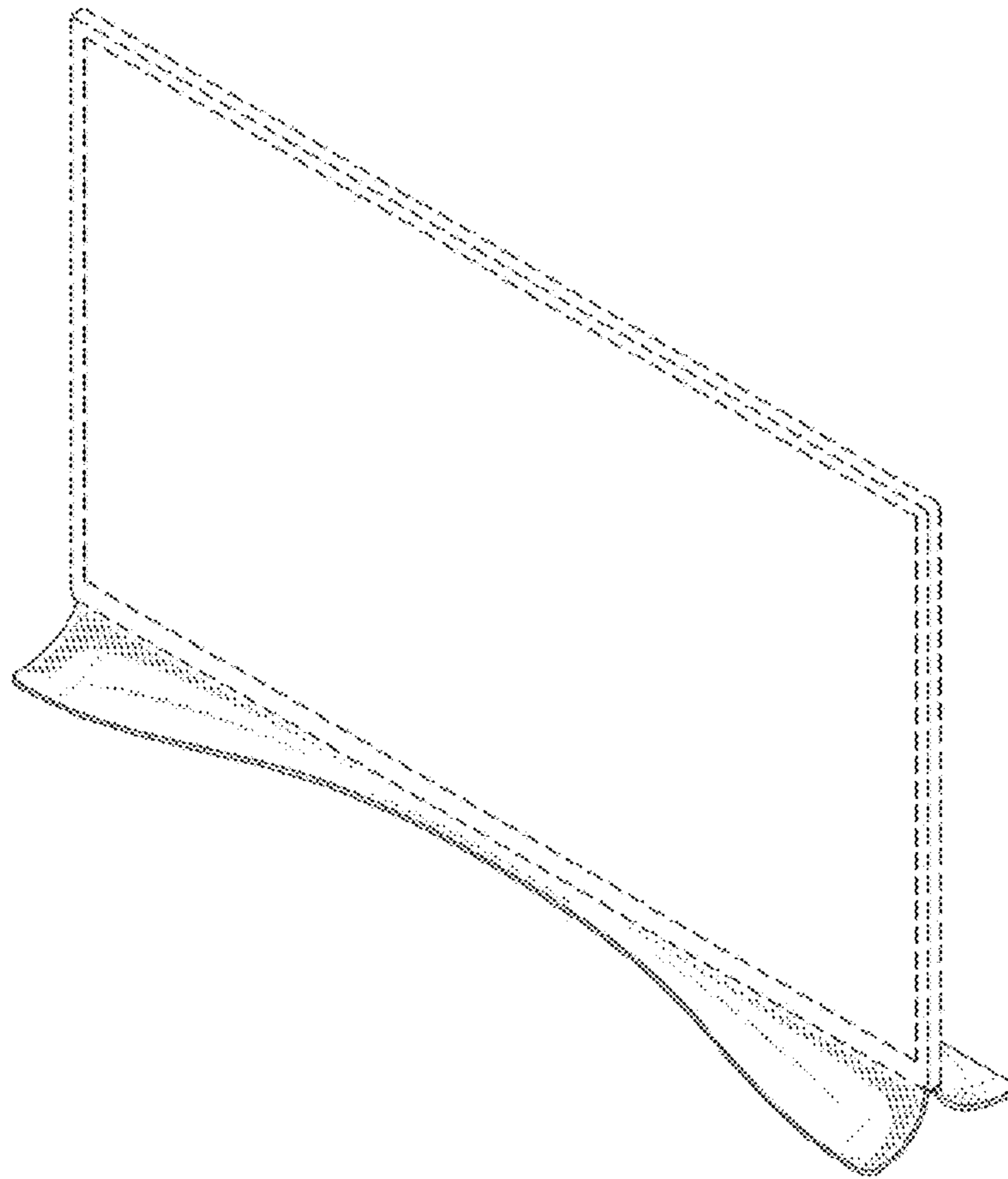

Fig. 1

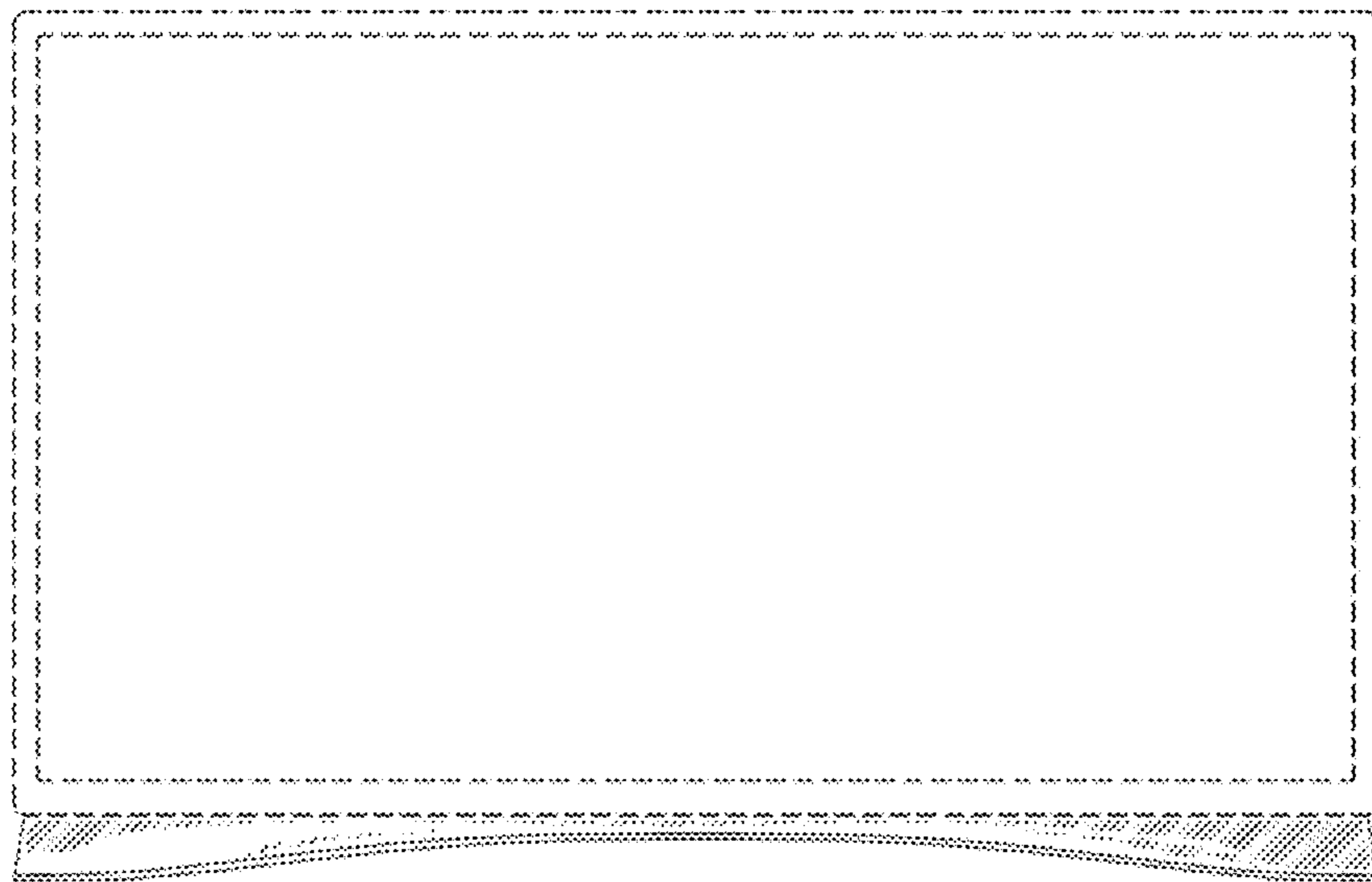

Fig. 2

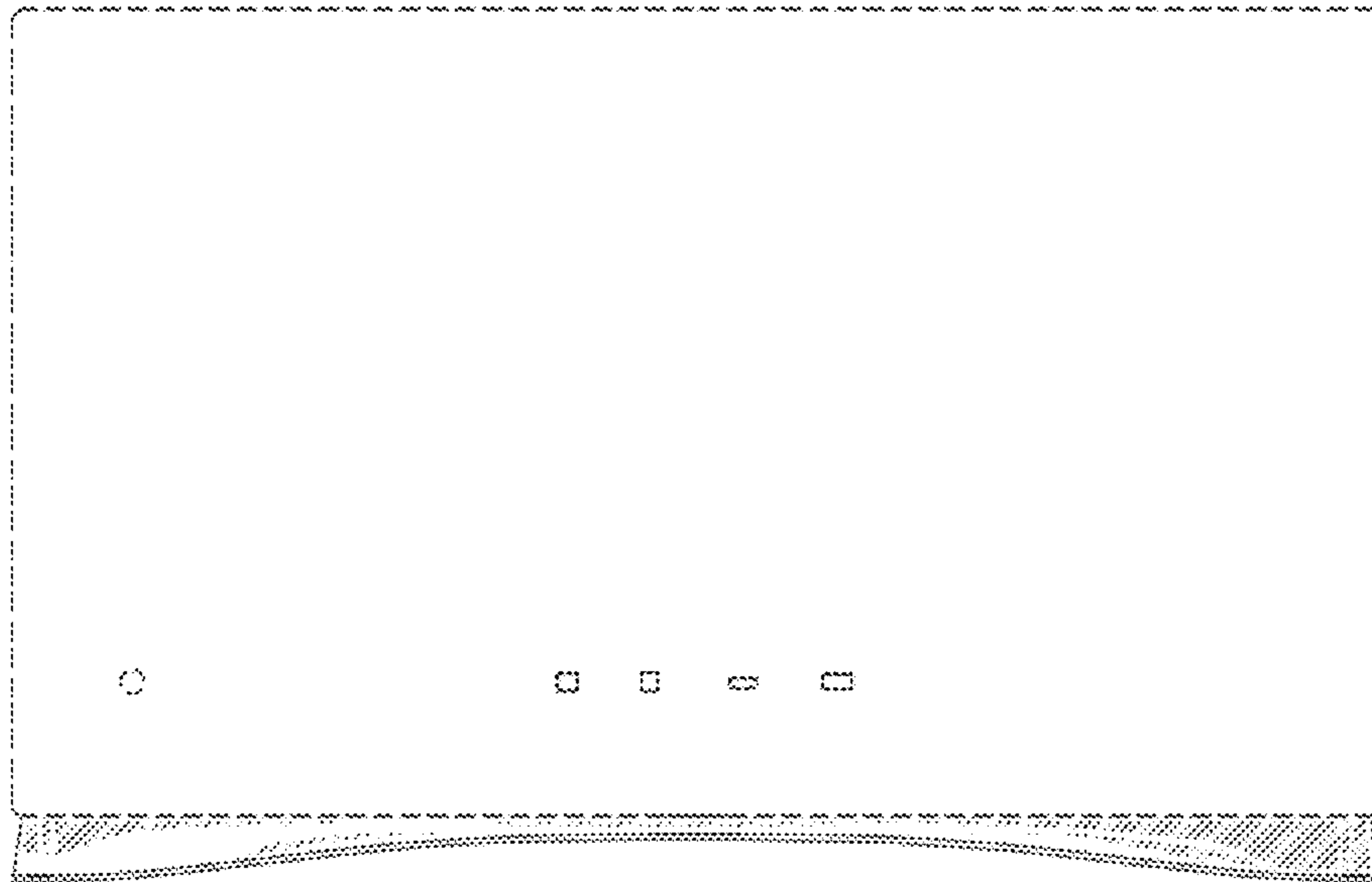

Fig. 3

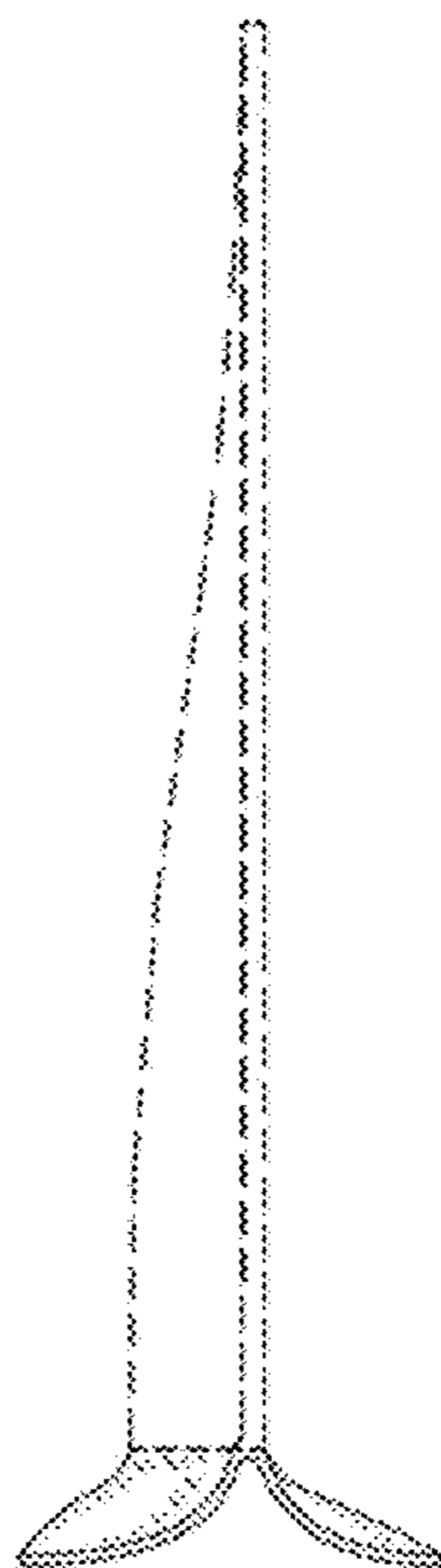

Fig. 4

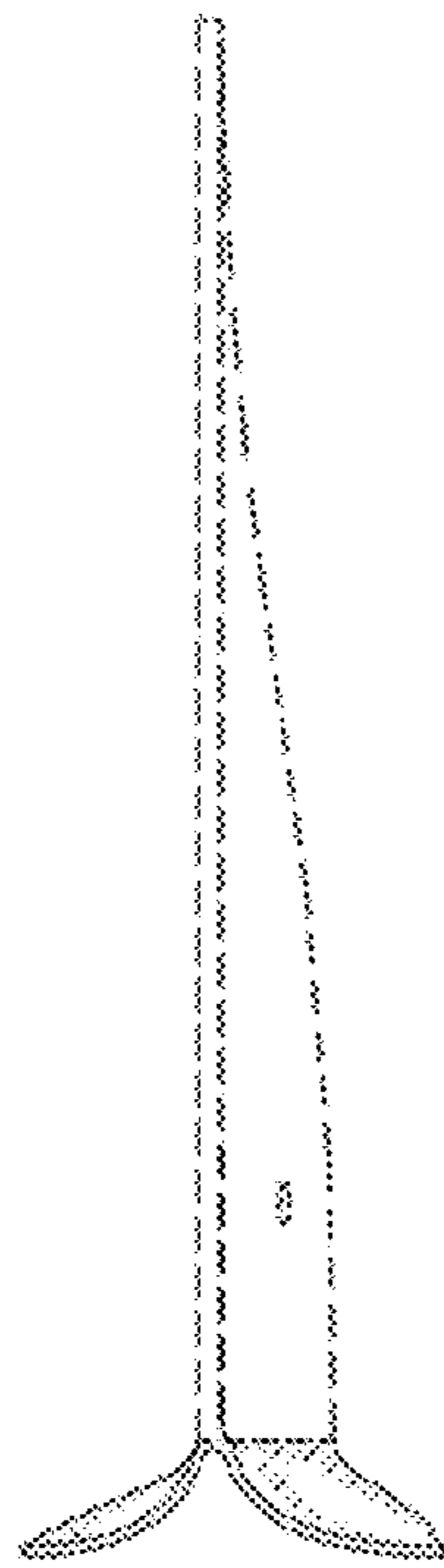

Fig. 5

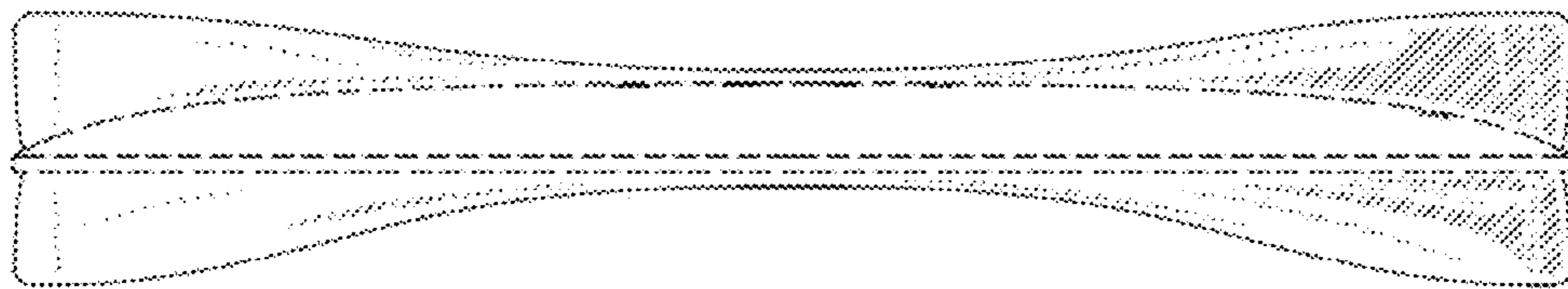

Fig. 6

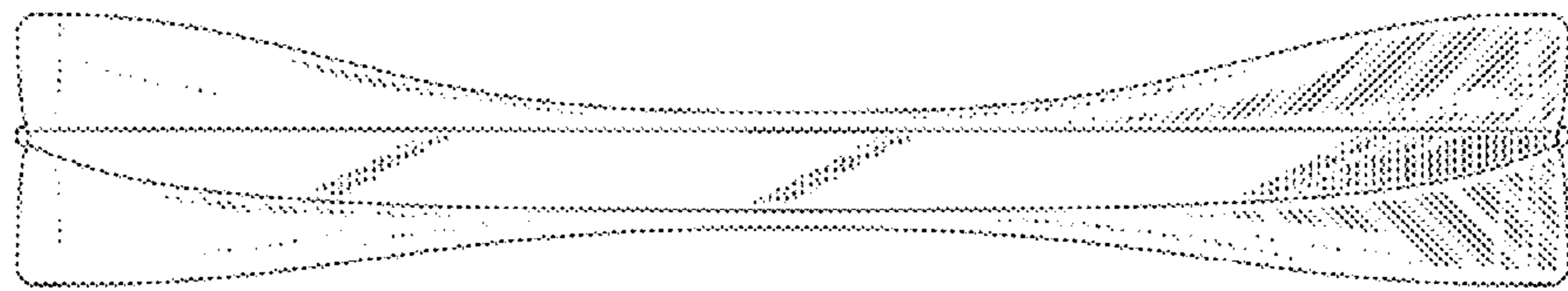

Fig. 7