



US00D763825S

(12) **United States Design Patent**
Zamir et al.

(10) **Patent No.:** **US D763,825 S**

(45) **Date of Patent:** **** Aug. 16, 2016**

(54) **SPEAKER**

(71) Applicant: **Bose Corporation**, Framingham, MA (US)

(72) Inventors: **Lee Zamir**, Cambridge, MA (US); **Darius Darayes Mobed**, Watertown, MA (US); **Michael Andrew Zalisk**, Arlington, MA (US); **Gustavo Fontana**, Framingham, MA (US)

(73) Assignee: **Bose Corporation**, Framingham, MA (US)

(**) Term: **14 Years**

(21) Appl. No.: **29/514,747**

(22) Filed: **Jan. 15, 2015**

(51) **LOC (10) Cl.** **14-03**

(52) **U.S. Cl.**
USPC **D14/215**

(58) **Field of Classification Search**
USPC D14/168, 170–172, 188, 194–196, 204, D14/207, 210–216, 219, 221, 222, 224, D14/496; 181/143, 144, 147, 148, 150, 153, 181/157, 198, 199; 381/300–303, 306, 332, 381/333, 336, 345, 361–364, 386–388
CPC B60R 11/0217; G06F 1/1688; H04M 1/03; H04M 1/035; H04R 1/02; H04R 1/06; H04R 1/021; H04R 1/025; H04R 1/026; H04R 1/028; H04R 1/105; H04R 1/323; H04R 1/403; H04R 1/2803; H04R 1/2834; H04R 5/02; H04R 7/20; H04R 9/06; H04R 9/025; H04R 2201/021; H04R 2400/00; H04R 2400/07; H04R 2499/11; H04R 2499/13; H04R 2499/15; H04S 3/00; H04S 7/30

See application file for complete search history.

(56) **References Cited**

U.S. PATENT DOCUMENTS

D243,620	S	*	3/1977	Williams	D14/221
D486,816	S	*	2/2004	Nakajima	D14/169
D495,012	S	*	8/2004	Morimoto	D14/188
D511,136	S	*	11/2005	Hirschburger	D13/107
7,640,045	B2	*	12/2009	Troutman	H04B 1/3888 455/3.02
D664,122	S	*	7/2012	Cho	D14/215
D674,371	S	*	1/2013	Cho	D14/188
D680,097	S	*	4/2013	Davies	D14/204
D718,736	S	*	12/2014	Thompson	D14/168
D725,075	S	*	3/2015	Wong	D14/215
2009/0290745	A1	*	11/2009	Weir	H01M 2/1022 381/387

* cited by examiner

Primary Examiner — Keli L Hill

(74) *Attorney, Agent, or Firm* — Bose Corporation

(57) **CLAIM**

The ornamental design for a speaker, substantially as shown and described.

DESCRIPTION

FIG. 1 is a front, top and left side perspective view of a speaker, showing our new design;
FIG. 2 is a front view thereof;
FIG. 3 is a back view thereof;
FIG. 4 is a top view thereof;
FIG. 5 is a bottom view thereof;
FIG. 6 is a left side view thereof; and,
FIG. 7 is a right side view thereof.
The dotted line portions of the drawings represent environmental structure only and do not form part of the claimed design.

1 Claim, 7 Drawing Sheets

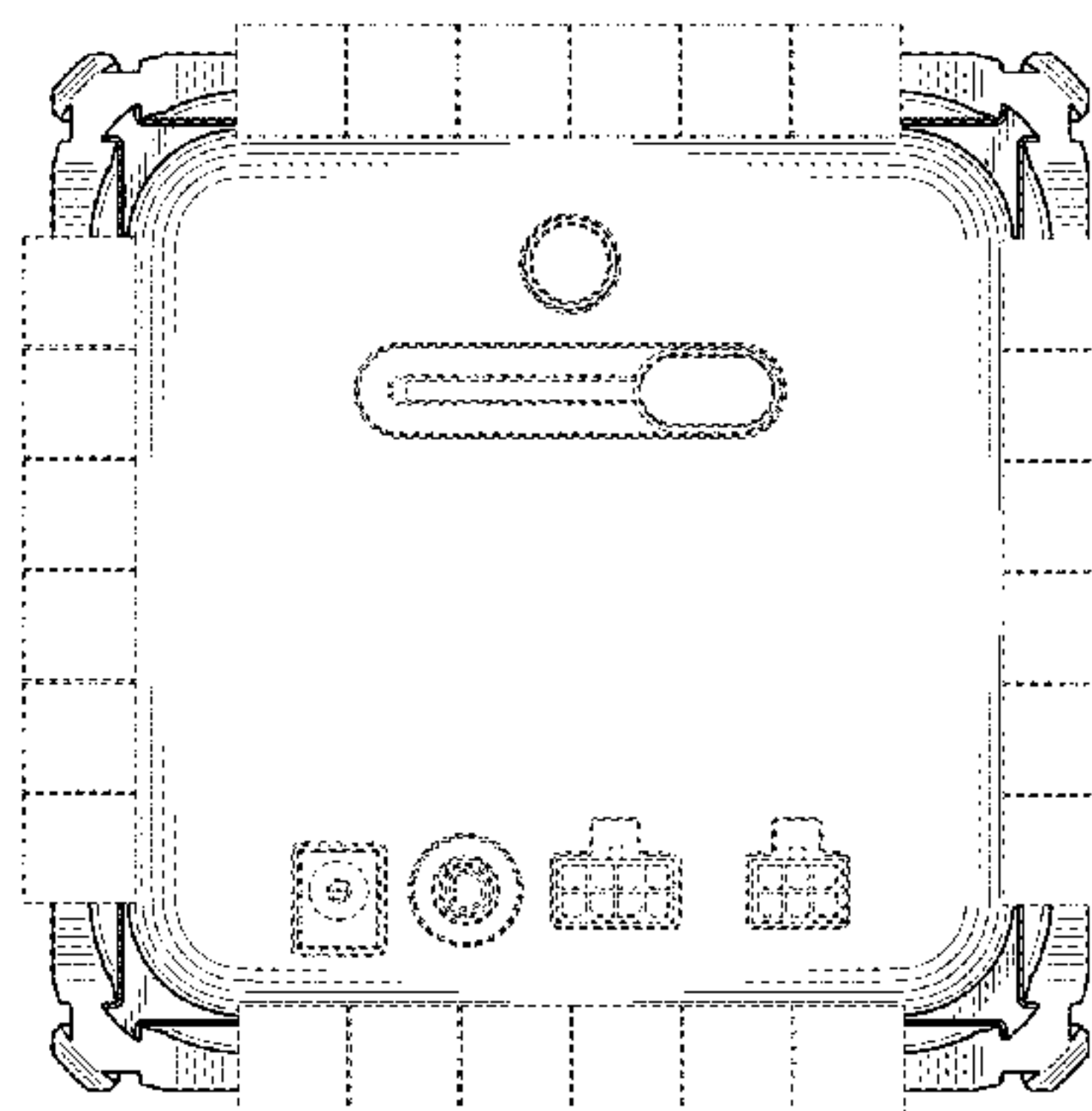
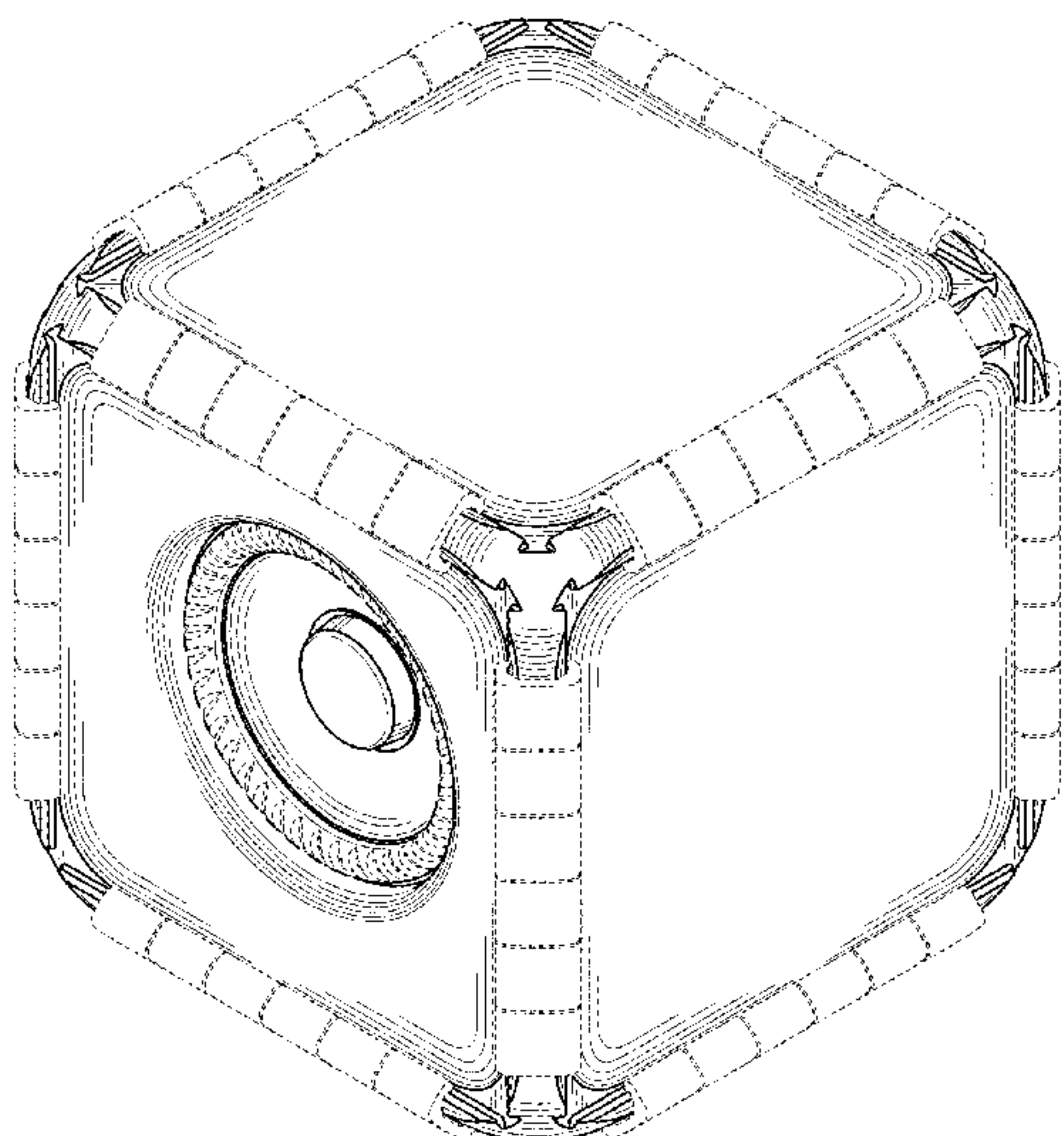

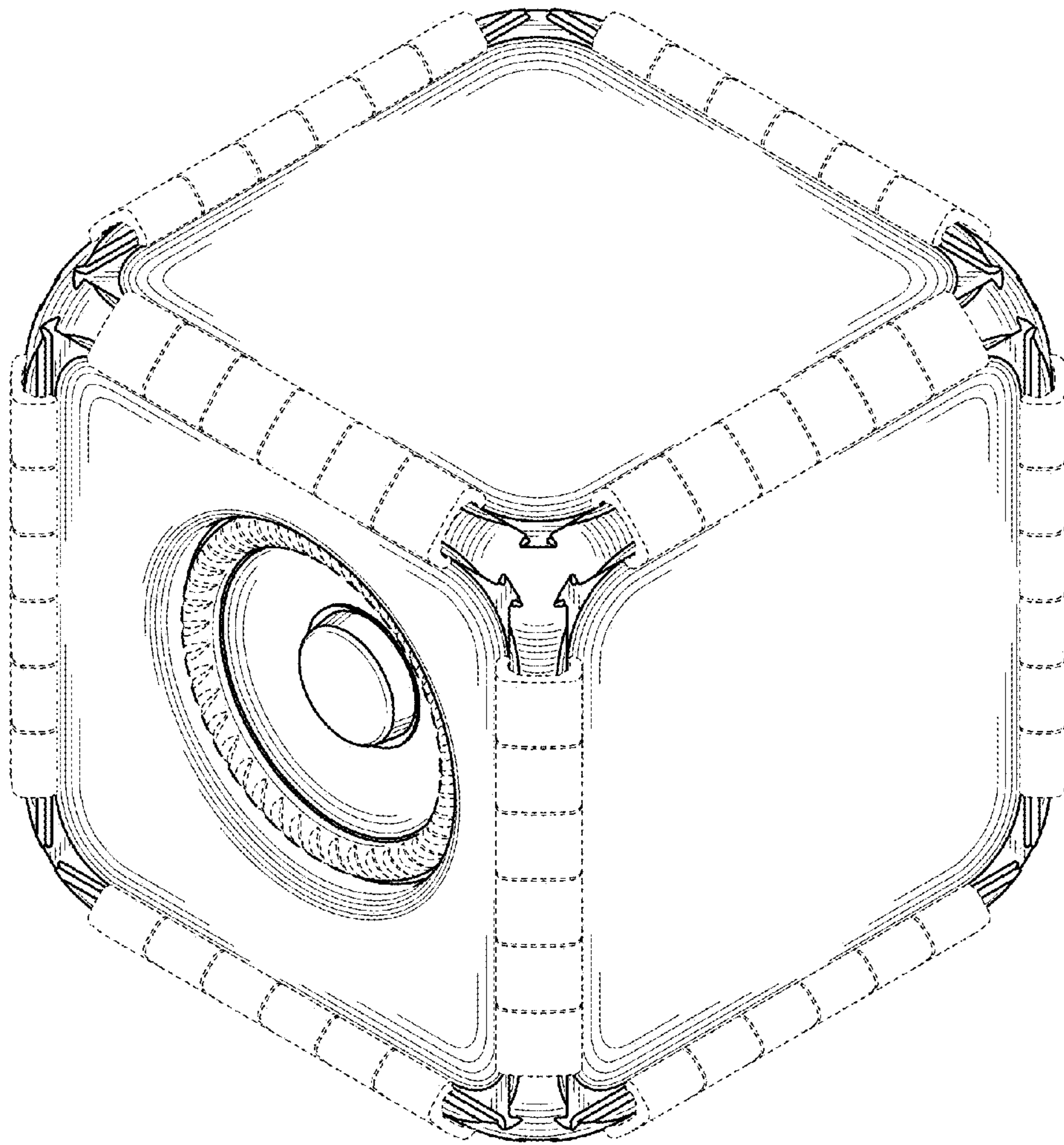

Fig. 1

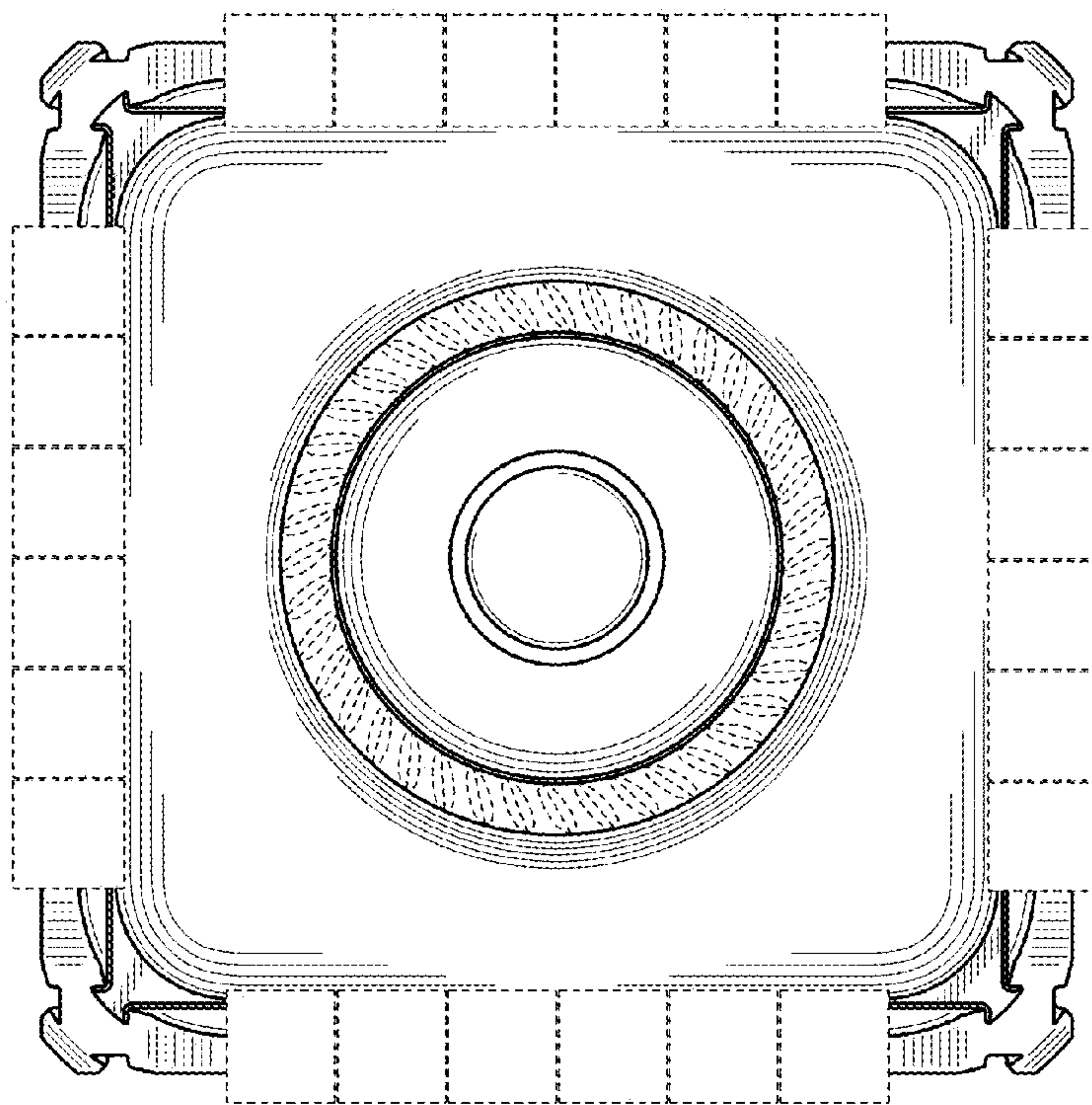

Fig. 2

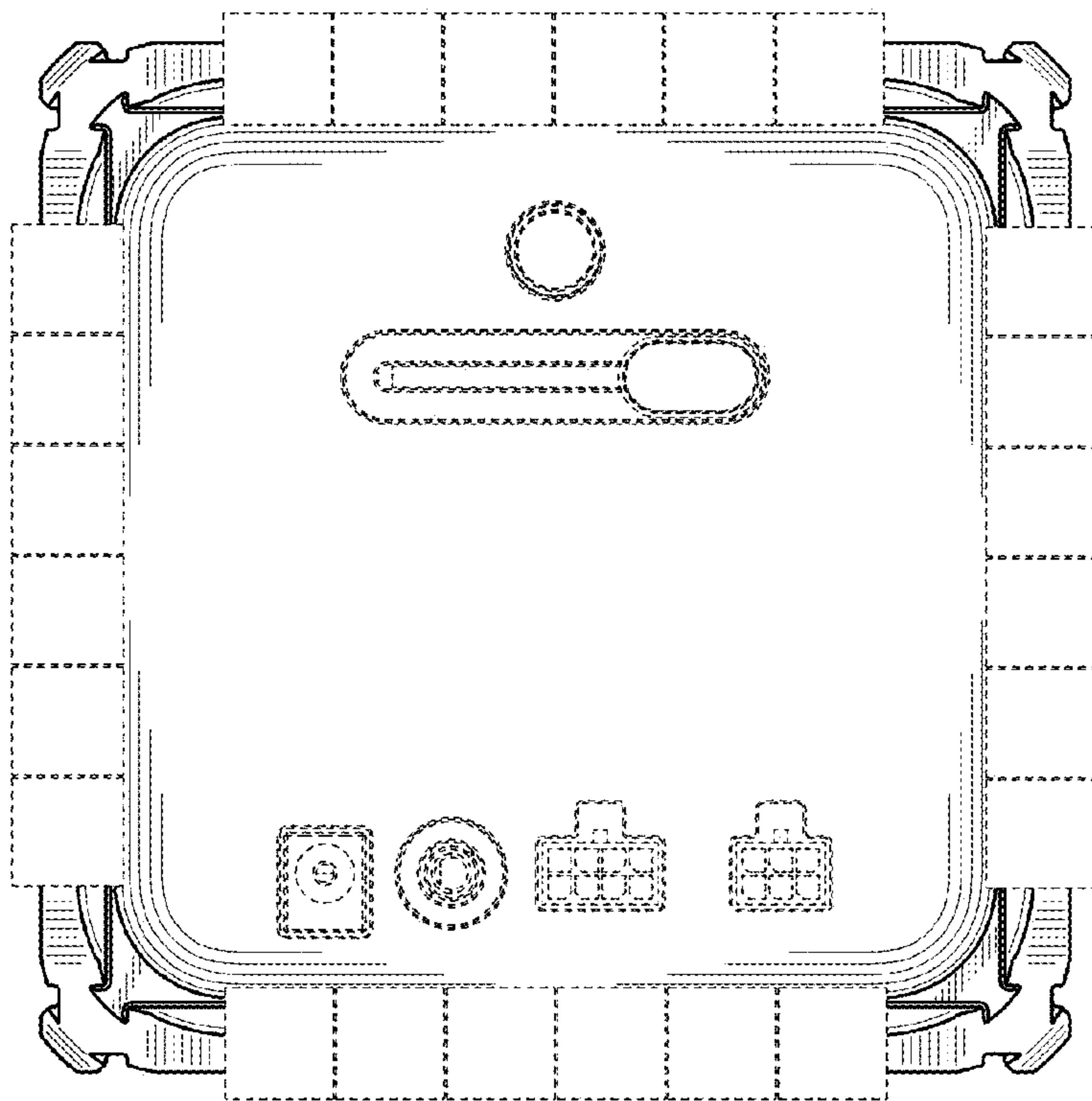

Fig. 3

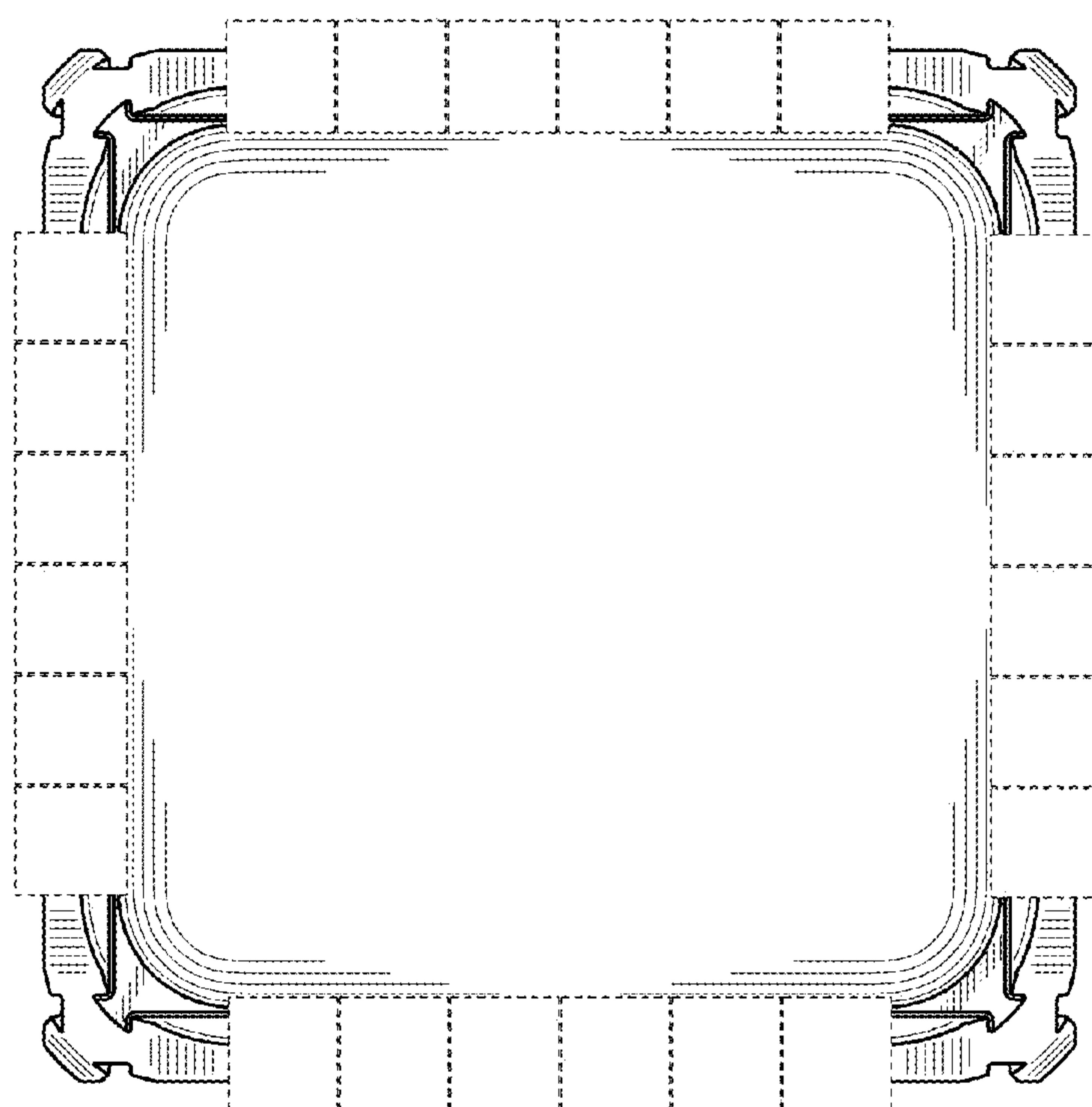

Fig. 4

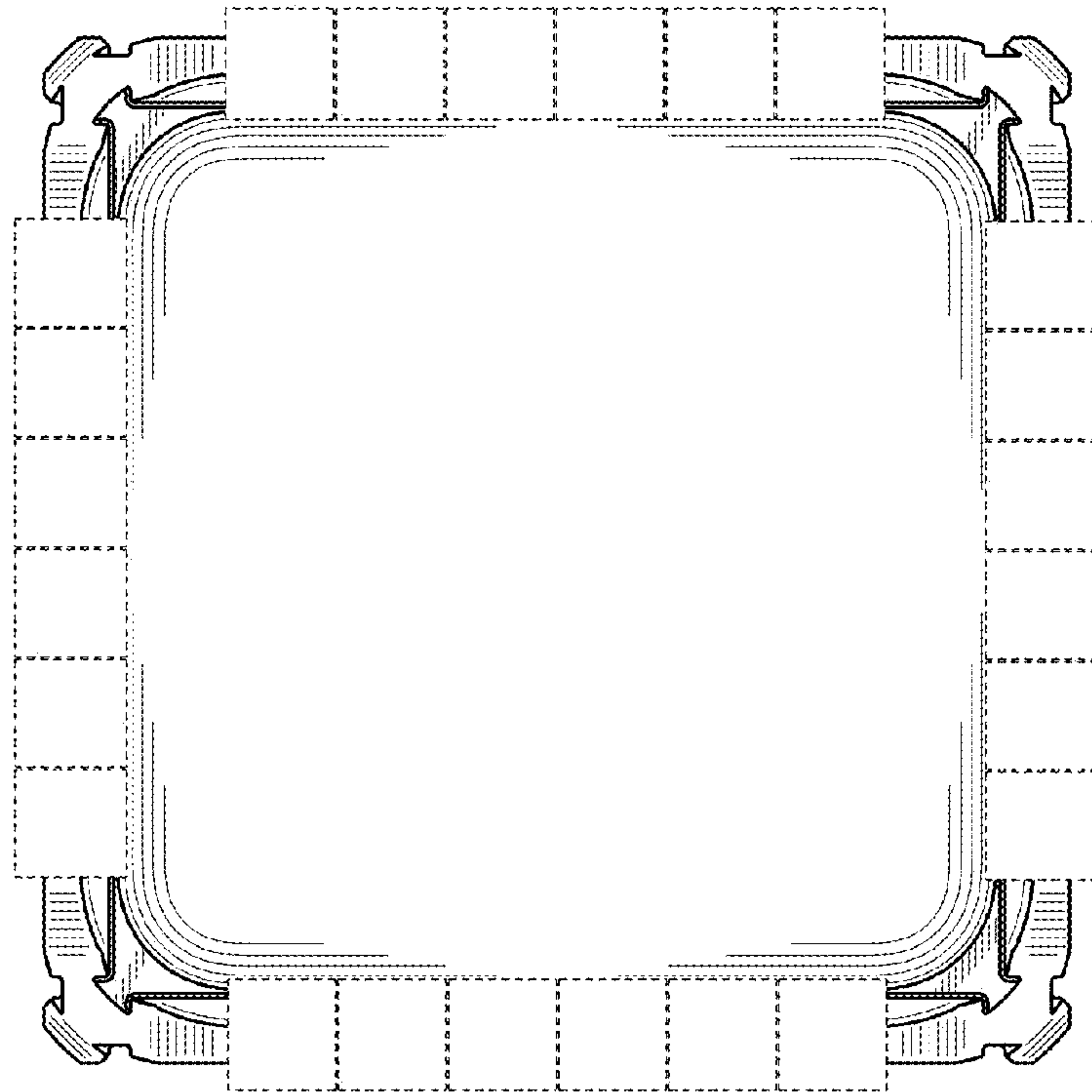

Fig. 5

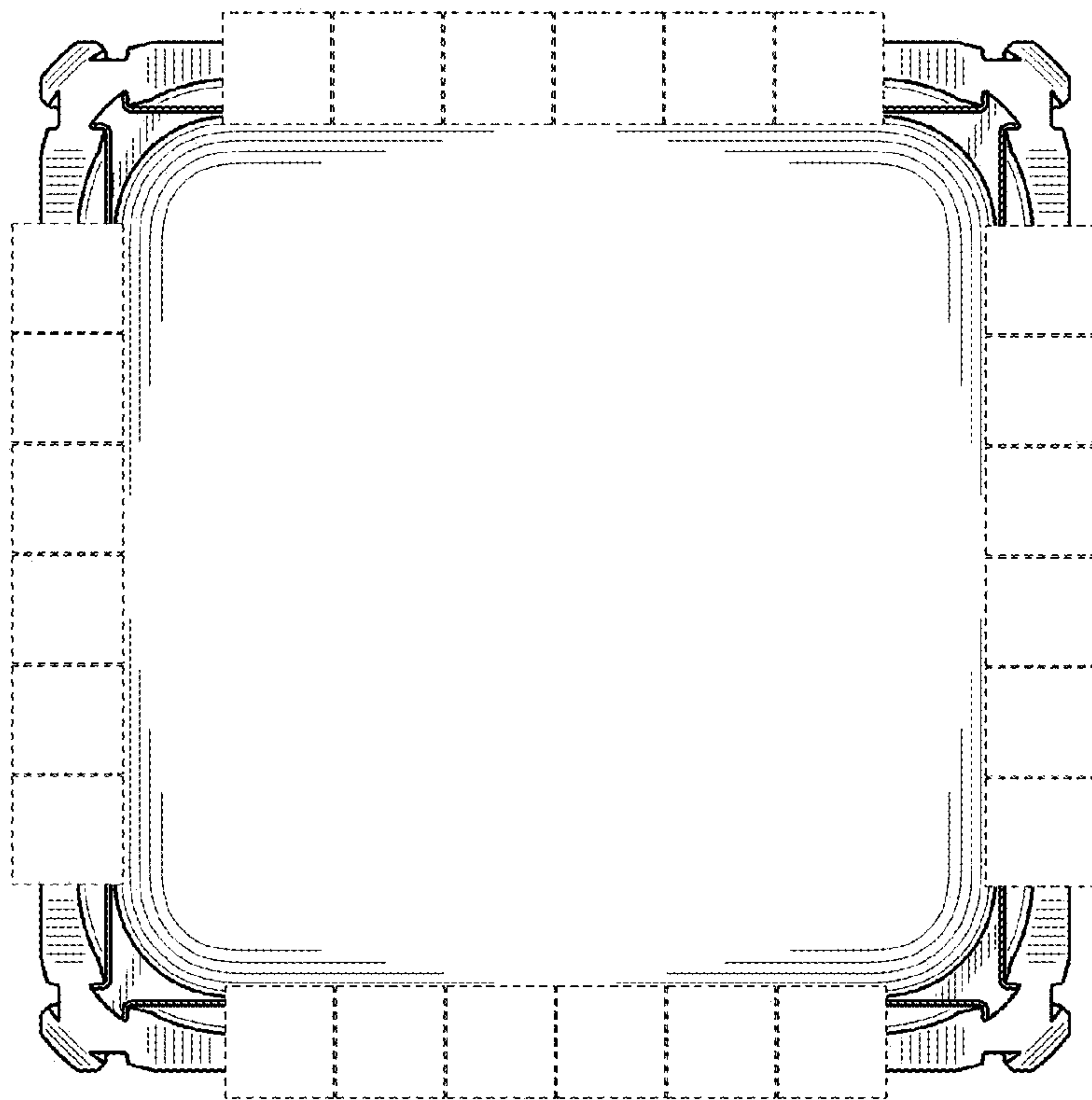

Fig. 6

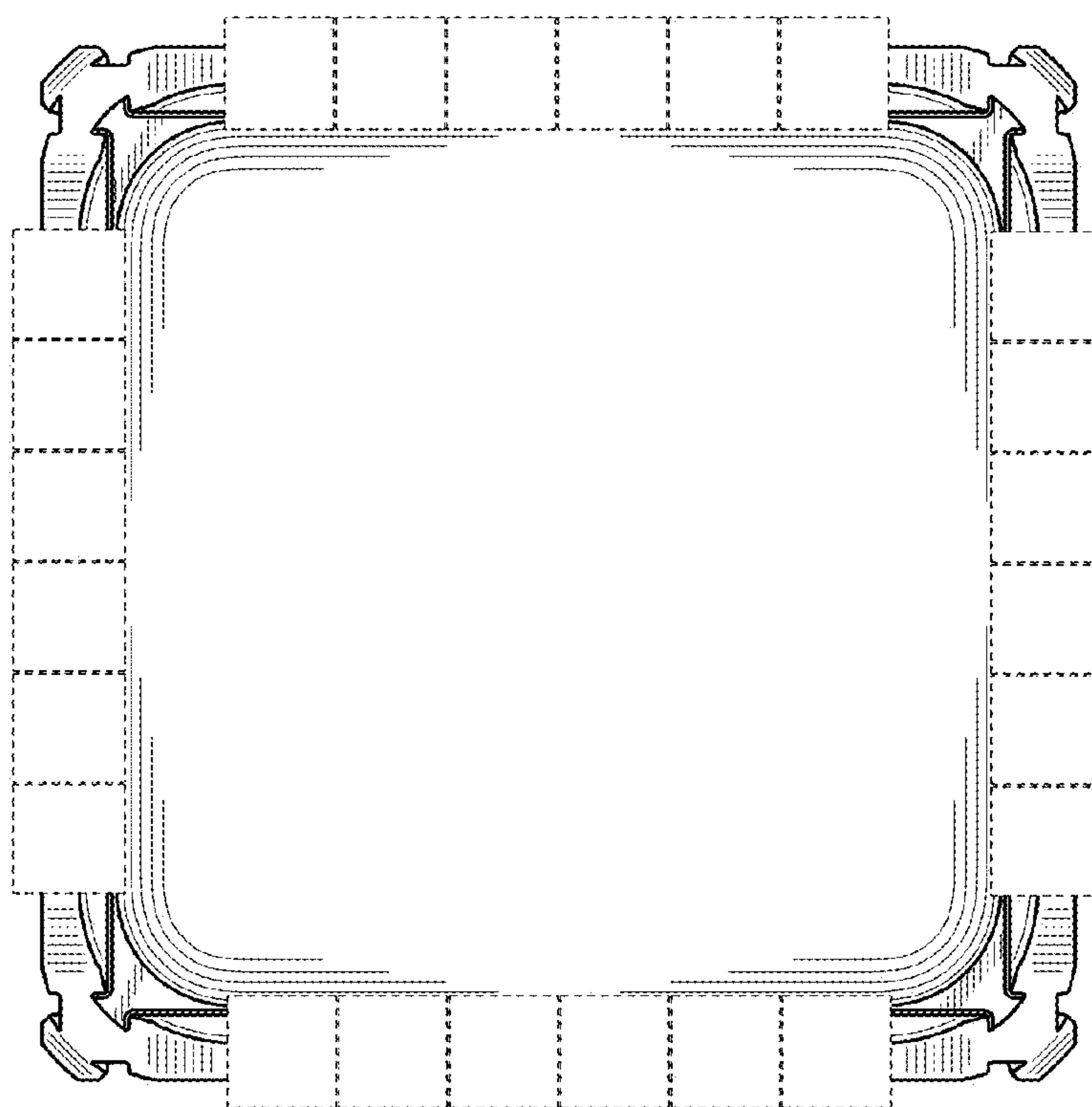

Fig. 7