



US00D763822S

(12) **United States Design Patent**
Lee et al.

(10) **Patent No.:** **US D763,822 S**
(45) **Date of Patent:** **** Aug. 16, 2016**

(54) **WIRELESS HEADSET**

(71) Applicant: **LG ELECTRONICS INC.**, Seoul (KR)

(72) Inventors: **Kunwoo Lee**, Seoul (KR); **Jaeyoung Kim**, Seoul (KR)

(73) Assignee: **LG ELECTRONICS INC.**, Seoul (KR)

(**) Term: **15 Years**

(21) Appl. No.: **29/531,157**

(22) Filed: **Jun. 23, 2015**

(30) **Foreign Application Priority Data**

Dec. 24, 2014 (KR) 30-2014-0063172

(51) **LOC (10) Cl.** **14-01**

(52) **U.S. Cl.**
USPC **D14/205**

(58) **Field of Classification Search**
USPC D14/205, 188, 192; D24/106; 128/864, 128/865; D16/309; 2/209.3; 181/129, 130, 181/135; 381/374, 380, 381, 74, 183, 151, 381/311, 326, 384, 378, 379, 351; 351/157, 351/158; 455/90.3, 100, 569.1, 575.2
CPC H04R 25/00; H04R 1/10; H04R 5/0335; H04R 5/033
See application file for complete search history.

(56) **References Cited**

U.S. PATENT DOCUMENTS

2,481,946 A * 9/1949 Pendleton G02C 3/003
2/450

2,891,116 A * 6/1959 Nichols H04R 25/602
381/323

D318,669 S * 7/1991 Nakayama D14/205

D337,587 S * 7/1993 Nakayama D14/205

D350,354 S * 9/1994 Nakamura D14/205

D351,597 S * 10/1994 Nakamura D14/205

6,010,216 A * 1/2000 Jesiek H04B 1/385
351/158

D458,245 S * 6/2002 Masuda D14/192

6,603,863 B1 * 8/2003 Nagayoshi H04R 5/0335
381/370

D550,202 S * 9/2007 Meier D14/206

D560,206 S * 1/2008 Hermansen D14/206

D575,268 S * 8/2008 Christopher D14/205

D579,442 S * 10/2008 Kim D14/205

D587,678 S * 3/2009 Yuyama D14/205

D587,680 S * 3/2009 Komiyama D14/205

D593,538 S * 6/2009 Chon D14/205

D594,442 S * 6/2009 Chon D14/205

D596,617 S * 7/2009 Devlas D14/205

D604,269 S * 11/2009 Choe D14/205

D617,308 S * 6/2010 Nousiainen D14/205

7,920,902 B2 * 4/2011 Carroll H04M 1/6066
381/74

8,009,853 B2 * 8/2011 Ito H04R 1/1066
381/370

D653,234 S * 1/2012 Lee D14/205

D654,444 S * 2/2012 Lin D13/180

D663,714 S * 7/2012 Kang D14/205

D669,881 S * 10/2012 Clements D14/205

D678,857 S * 3/2013 Feng D14/205

(Continued)

Primary Examiner — Paula Greene

(74) *Attorney, Agent, or Firm* — Birch, Stewart, Kolasch & Birch, LLP

(57) **CLAIM**

The ornamental design for wireless headset, as shown and described.

DESCRIPTION

FIG. 1 is a perspective view of a wireless headset showing our new design;

FIG. 2 is a front view thereof;

FIG. 3 is a rear view thereof;

FIG. 4 is a left side view thereof;

FIG. 5 is a right side view thereof;

FIG. 6 is a top plan view thereof;

FIG. 7 is a bottom plan view thereof; and,

FIG. 8 is a reference view thereof showing an example of the usage of the subject design.

The broken lines depict portions of the wireless headset that form no part of the claimed design.

1 Claim, 7 Drawing Sheets

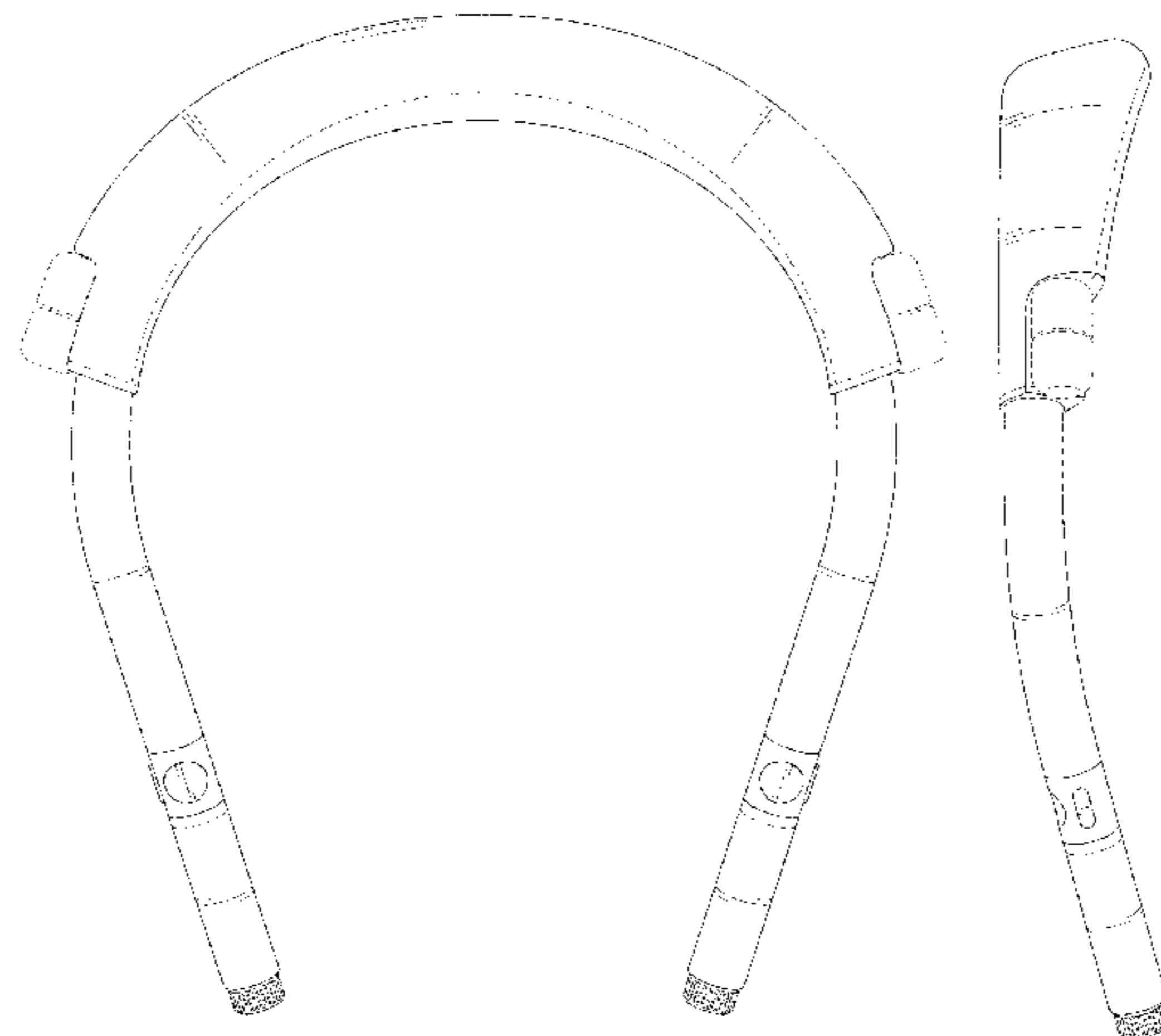

(56)

References Cited

U.S. PATENT DOCUMENTS

8,411,893 B2 *	4/2013	Ito	H04R 1/105 181/135	D743,933 S *	11/2015	Park	D14/205
8,433,082 B2 *	4/2013	Abolfathi	H04R 1/46 381/151	D756,958 S *	5/2016	Lee	D14/205
D686,189 S *	7/2013	Lu	D14/205	D756,959 S *	5/2016	Lee	D14/205
D703,634 S *	4/2014	Han	D14/205	2007/0003093 A1 *	1/2007	Ito	H04R 5/0335 381/378
D706,745 S *	6/2014	Nakagawa	D14/205	2009/0274335 A1 *	11/2009	Cheung	H04R 5/0335 381/374
D707,199 S *	6/2014	Cepress	D14/205	2010/0283962 A1 *	11/2010	Williams	G02C 3/003 351/157
D716,759 S *	11/2014	Ha	D14/205	2011/0170702 A1 *	7/2011	Bays	H04R 5/0335 381/74
D721,673 S *	1/2015	Park	D14/205	2012/0170702 A1 *	7/2012	Song	F22B 35/004 376/210
D723,510 S *	3/2015	Ishikura	D14/205	2013/0329903 A1 *	12/2013	Ting	H04R 1/105 381/74
D730,867 S *	6/2015	Park	D14/205	2014/0185837 A1 *	7/2014	Kunimoto	H04R 1/1075 381/151
D731,999 S *	6/2015	Cepress	D14/205					
9,055,795 B2 *	6/2015	Larkin	A45C 11/00					

* cited by examiner

FIG. 1

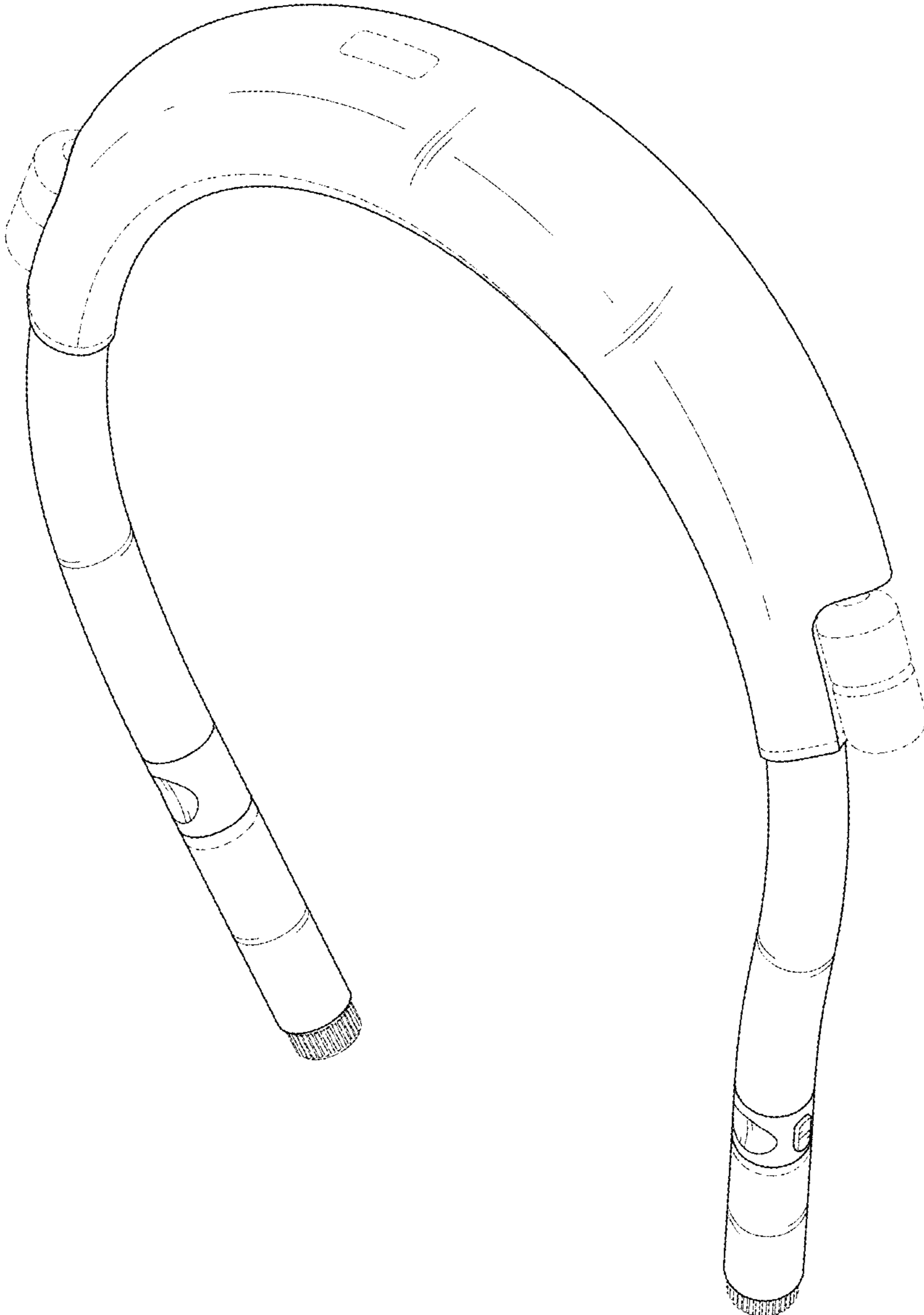

FIG. 2

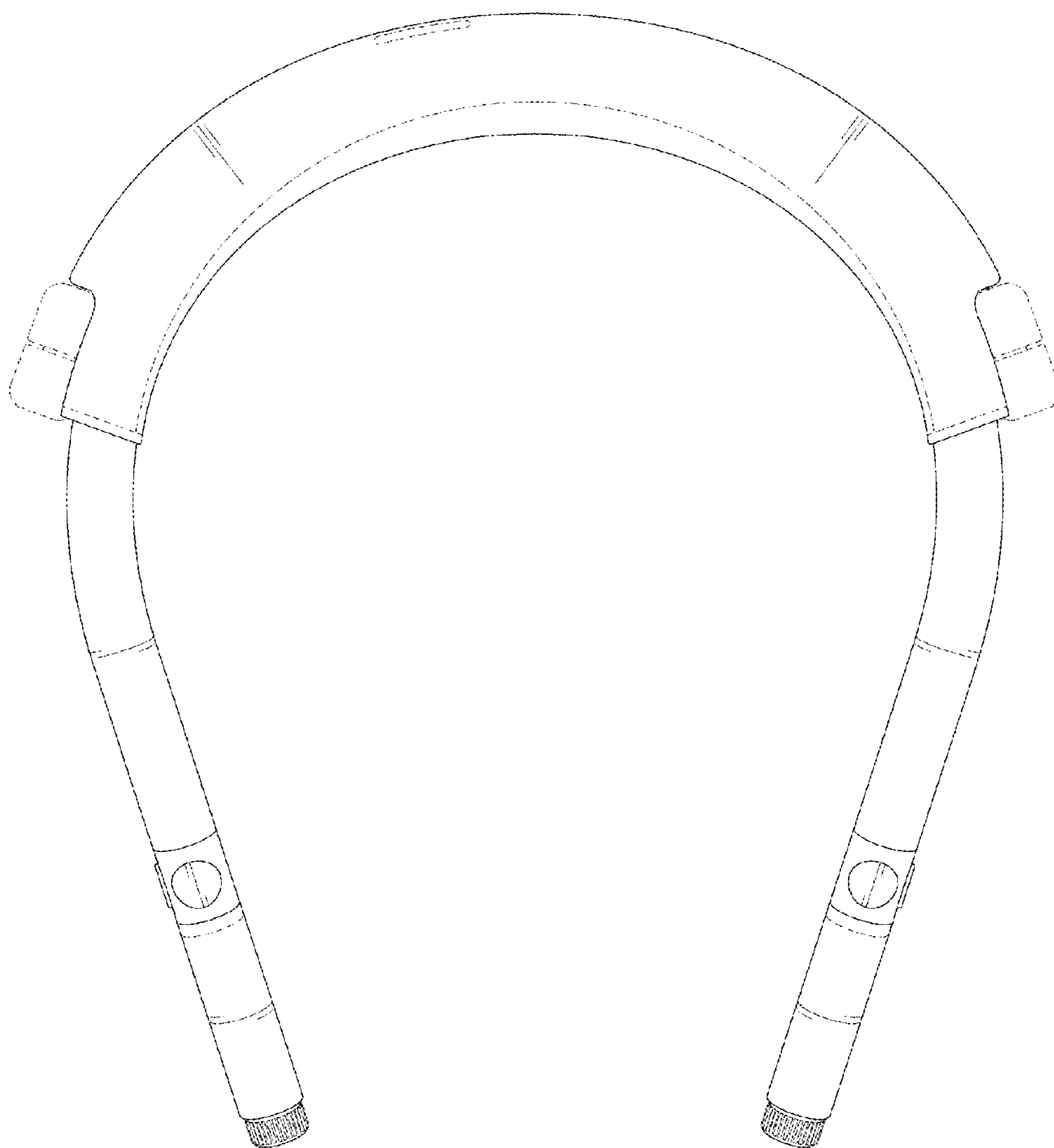

FIG. 3

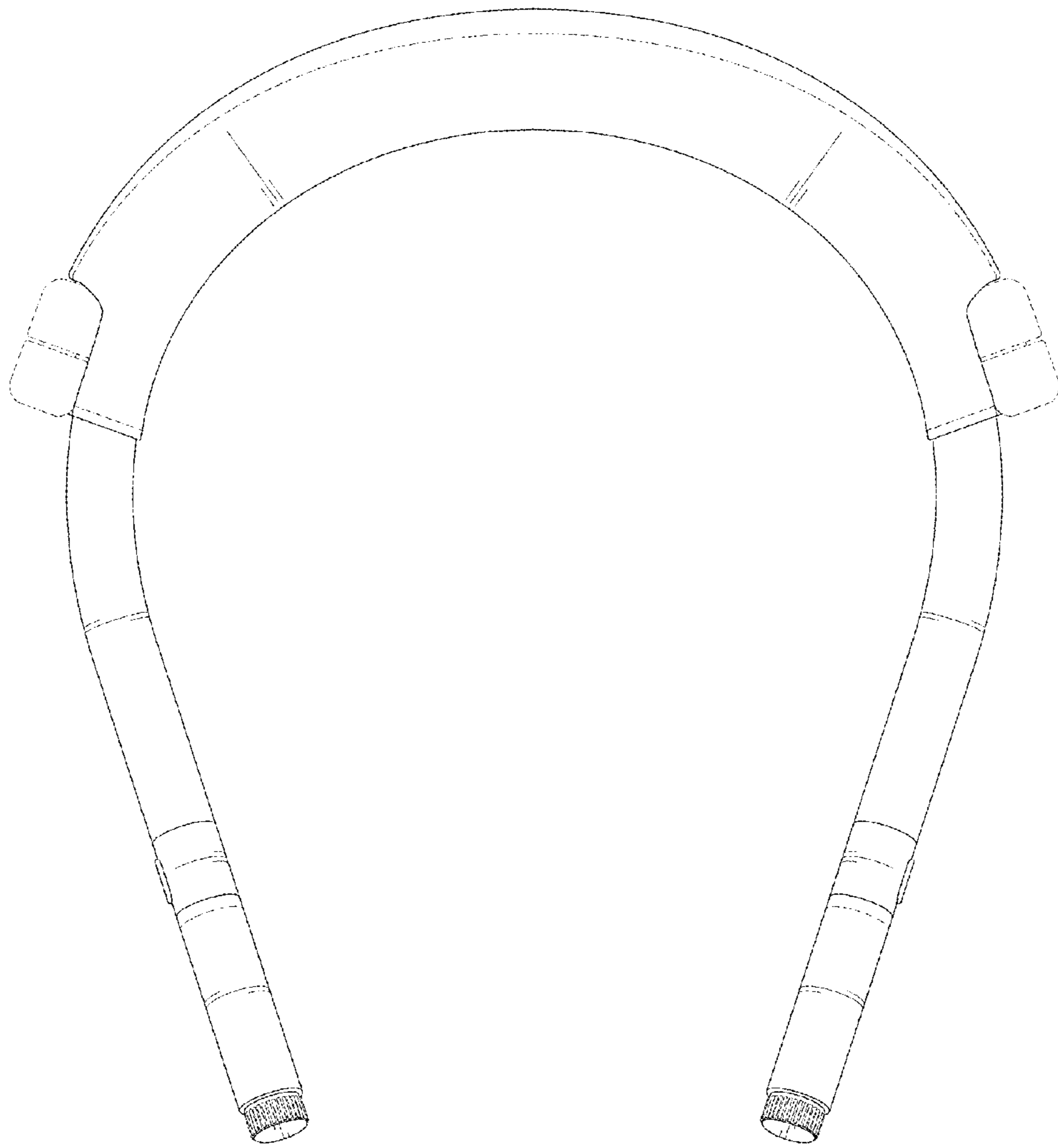

FIG. 4

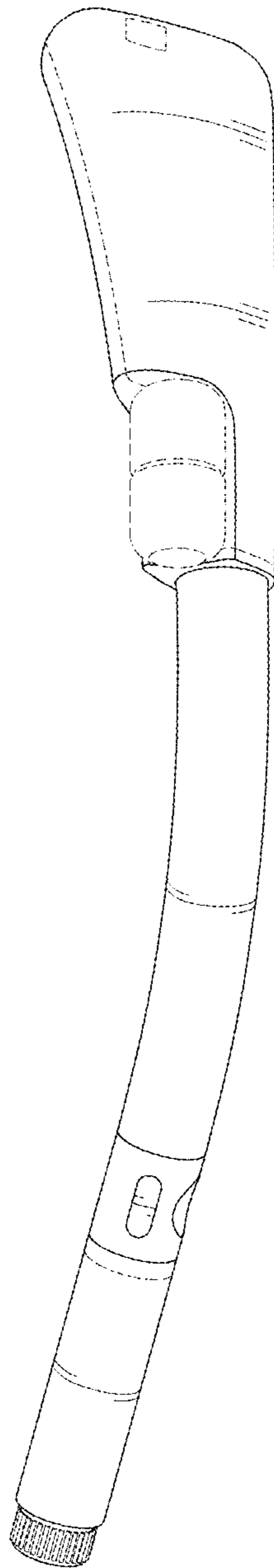

FIG. 5

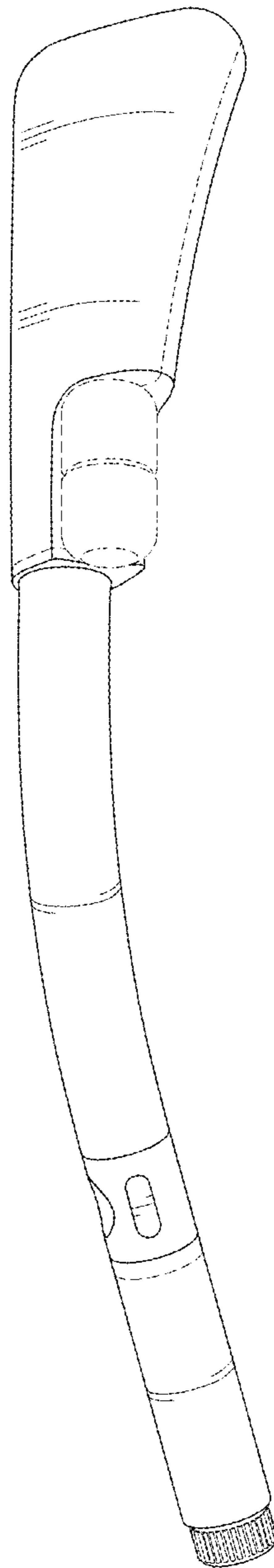

FIG. 6

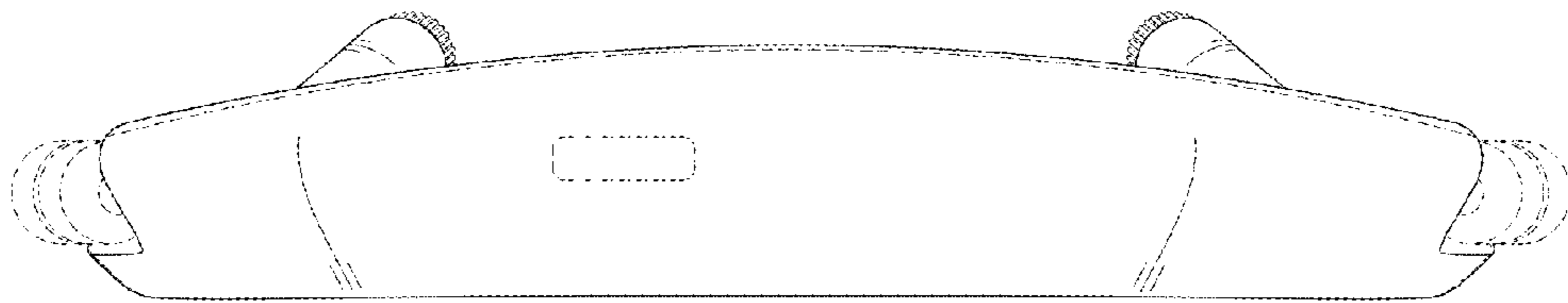

FIG. 7

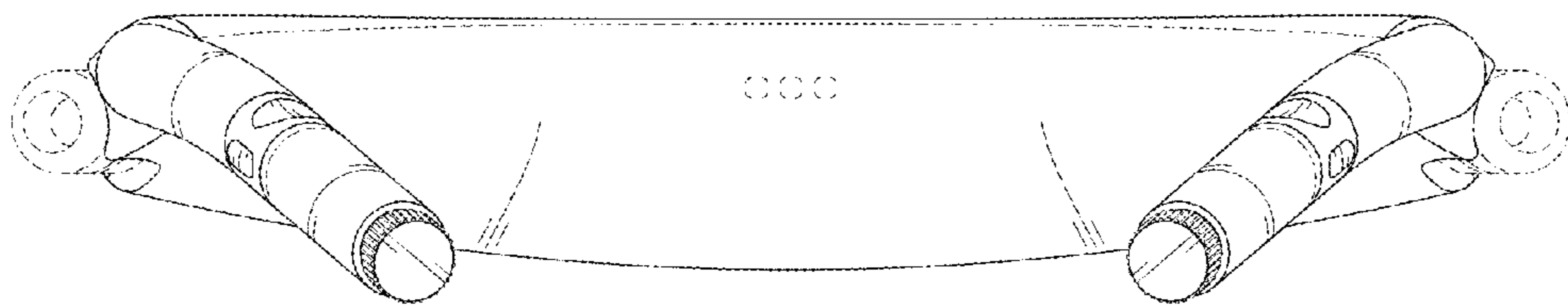

FIG. 8

