



US00D763698S

(12) **United States Design Patent**
Dunster et al.

(10) **Patent No.:** **US D763,698 S**
(45) **Date of Patent:** **** Aug. 16, 2016**

(54) **CONTAINER**

- (71) Applicant: **Silgan Plastics LLC**, Chesterfield, MO (US)
- (72) Inventors: **Alfred John Dunster**, Kelowna (CA);
James D. Janeczek, Tecumseh, MI (US)
- (73) Assignee: **Silgan Plastics LLC**, Chesterfield, MO (US)
- (**) Term: **14 Years**

(21) Appl. No.: **29/493,927**

(22) Filed: **Jun. 16, 2014**

(51) **LOC (10) Cl.** **09-01**

(52) **U.S. Cl.**
USPC **D9/575**

(58) **Field of Classification Search**

USPC D9/516, 520, 522, 530, 531, 536, 543,
D9/563, 572-574; 215/14, 214, 217, 223,
215/379, 382-385, 396, 398; 220/220, 890;
222/210, 212, 215
CPC B65D 1/0223; B65D 1/0284; B65D 23/10;
B65D 2501/0081; B65D 2203/02
See application file for complete search history.

(56) **References Cited**

U.S. PATENT DOCUMENTS

D206,828 S *	1/1967	Fox	D9/531
D286,379 S *	10/1986	Lyons	D9/520
D348,612 S *	7/1994	Ring	D9/531
D371,740 S *	7/1996	Lathrop	D9/528
D401,506 S *	11/1998	Collins, II	D9/528
D409,494 S *	5/1999	Frazer	D9/520
D429,465 S *	8/2000	Weeden	D9/528
D502,875 S *	3/2005	Bowen	D9/528
D512,320 S *	12/2005	Haley	D9/531
7,137,521 B2 *	11/2006	Yourist	B65D 1/0223 215/379
D556,041 S	11/2007	Flanagan-Kent et al.		
D570,222 S	6/2008	Flanagan-Kent et al.		
D585,748 S	2/2009	Flanagan-Kent et al.		
D588,008 S	3/2009	Flanagan-Kent et al.		

(Continued)

OTHER PUBLICATIONS

U.S. Appl. No. 14/186,807, filed Feb. 21, 2014, Hayward et al.

(Continued)

Primary Examiner — Derrick Holland

Assistant Examiner — Janice Lim

(74) *Attorney, Agent, or Firm* — Reinhart Boerner Van Deuren s.c.

(57) **CLAIM**

The ornamental design for a container, as shown and described.

DESCRIPTION

FIG. 1 is a front perspective view of a container, of embodiment one, showing our new design;
 FIG. 2 is a bottom perspective view thereof;
 FIG. 3 is a front view thereof;
 FIG. 4 is a rear view thereof;
 FIG. 5 is a left side view thereof;
 FIG. 6 is a right side view thereof;
 FIG. 7 is a top plan view thereof;
 FIG. 8 is a bottom plan view thereof;
 FIG. 9 is a front perspective view of a container, of embodiment two, showing our new design;
 FIG. 10 is a bottom perspective view thereof;
 FIG. 11 is a front view thereof;
 FIG. 12 is a rear view thereof;
 FIG. 13 is a left side view thereof;
 FIG. 14 is a right side view thereof;
 FIG. 15 is a top plan view thereof; and,
 FIG. 16 is a bottom plan view thereof.

The ornamental design which is claimed is shown in solid lines in the drawings. The broken dot-dash lines define boundaries of the claimed design and form no part thereof. The broken line portions are included to show unclaimed subject matter only and form no part of the claimed design.

1 Claim, 16 Drawing Sheets

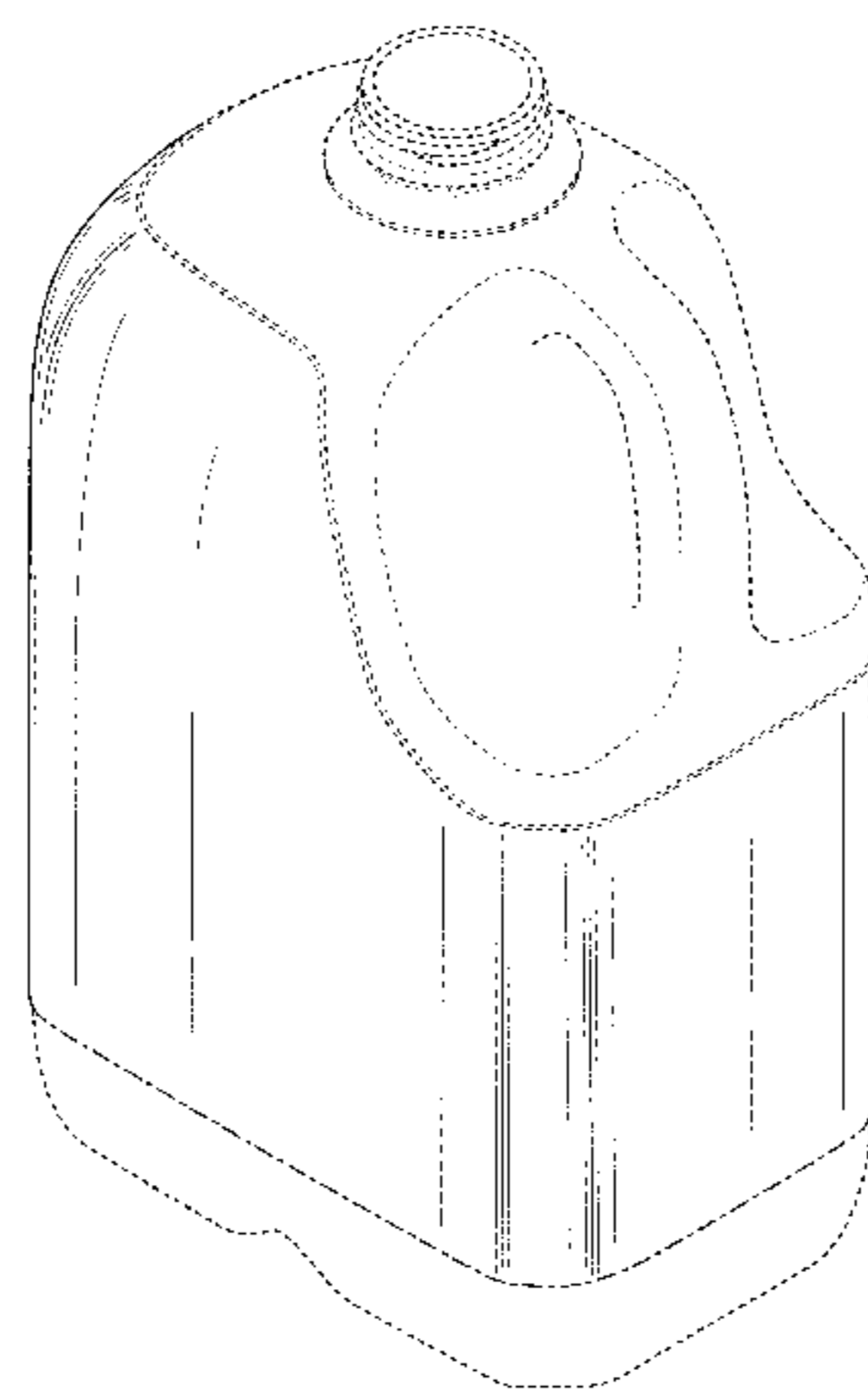
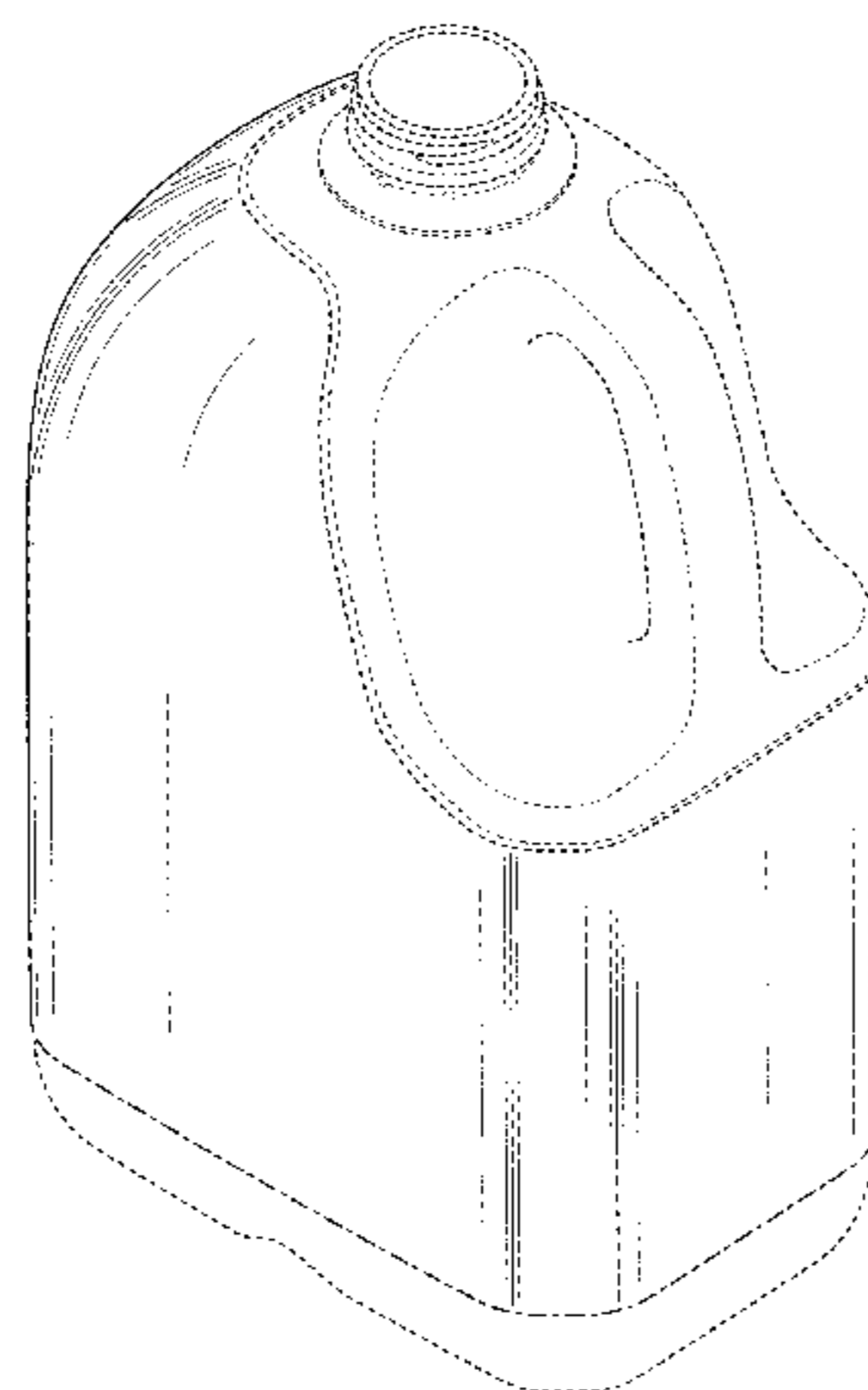

(56)

References Cited

U.S. PATENT DOCUMENTS

D604,623 S * 11/2009 Baker, III D9/531
D612,734 S * 3/2010 Sarsfield-Thomas D9/516
D639,171 S * 6/2011 Davis D9/528
D663,212 S 7/2012 DiBiasio et al.
D678,773 S 3/2013 DiBiasio et al.

D696,129 S 12/2013 DiBiasio et al.
2009/0072055 A1 3/2009 Flanagan-Kent et al.

OTHER PUBLICATIONS

U.S. Appl. No. 29/472,156, filed Nov. 8, 2013, DiBiasio et al.
U.S. Appl. No. 13/720,616, filed Dec. 19, 2012, Flanagan-Kent et al.

* cited by examiner

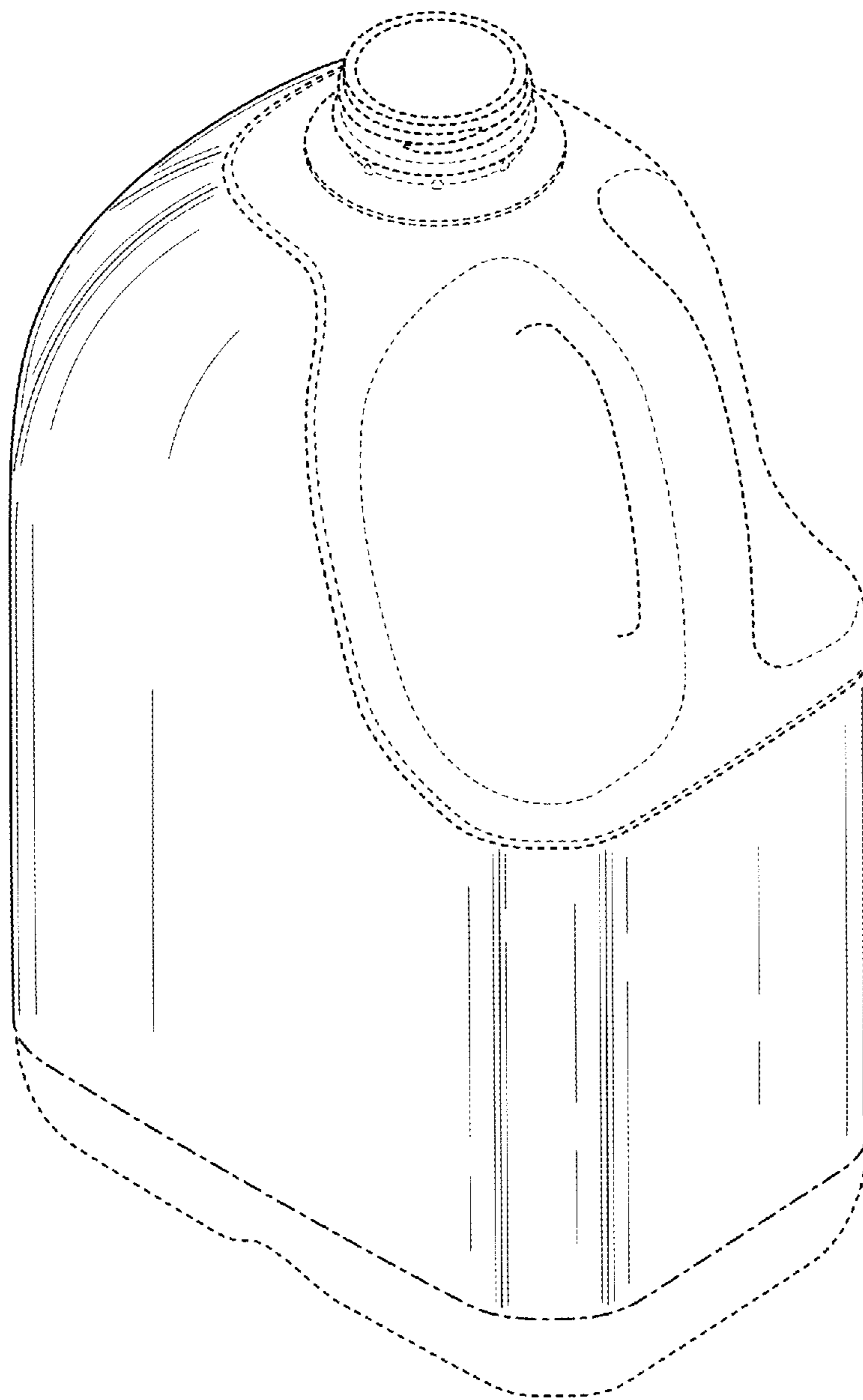

FIG. 1

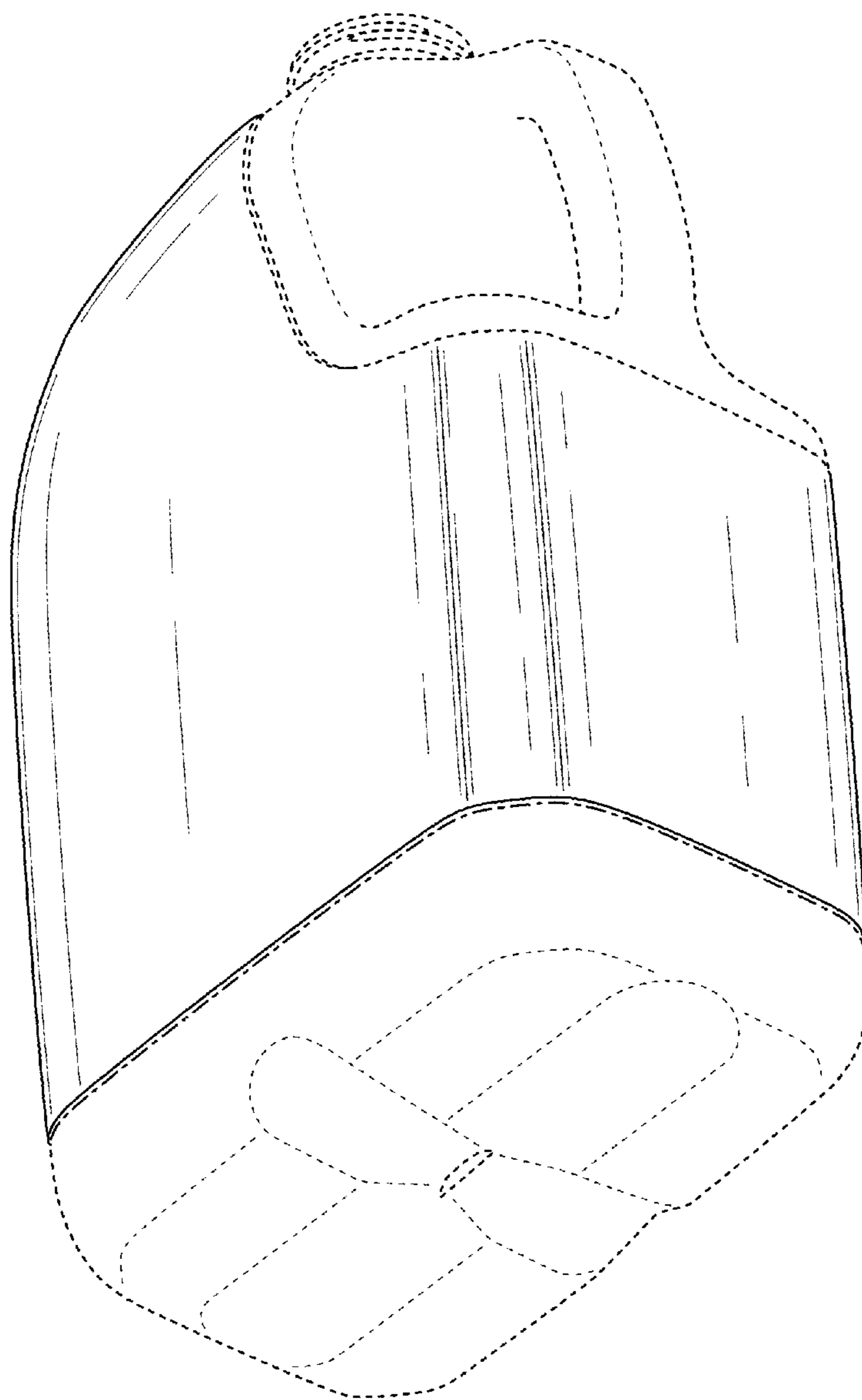

FIG. 2

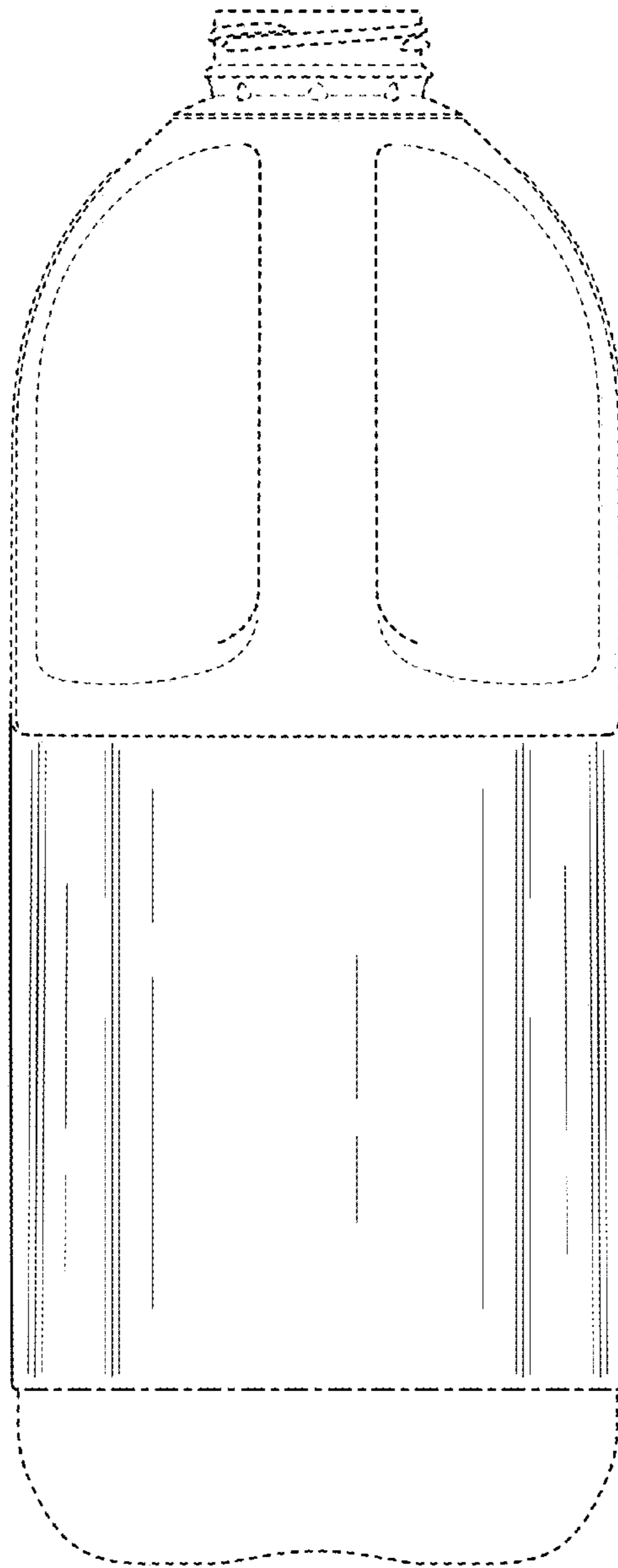

FIG. 3

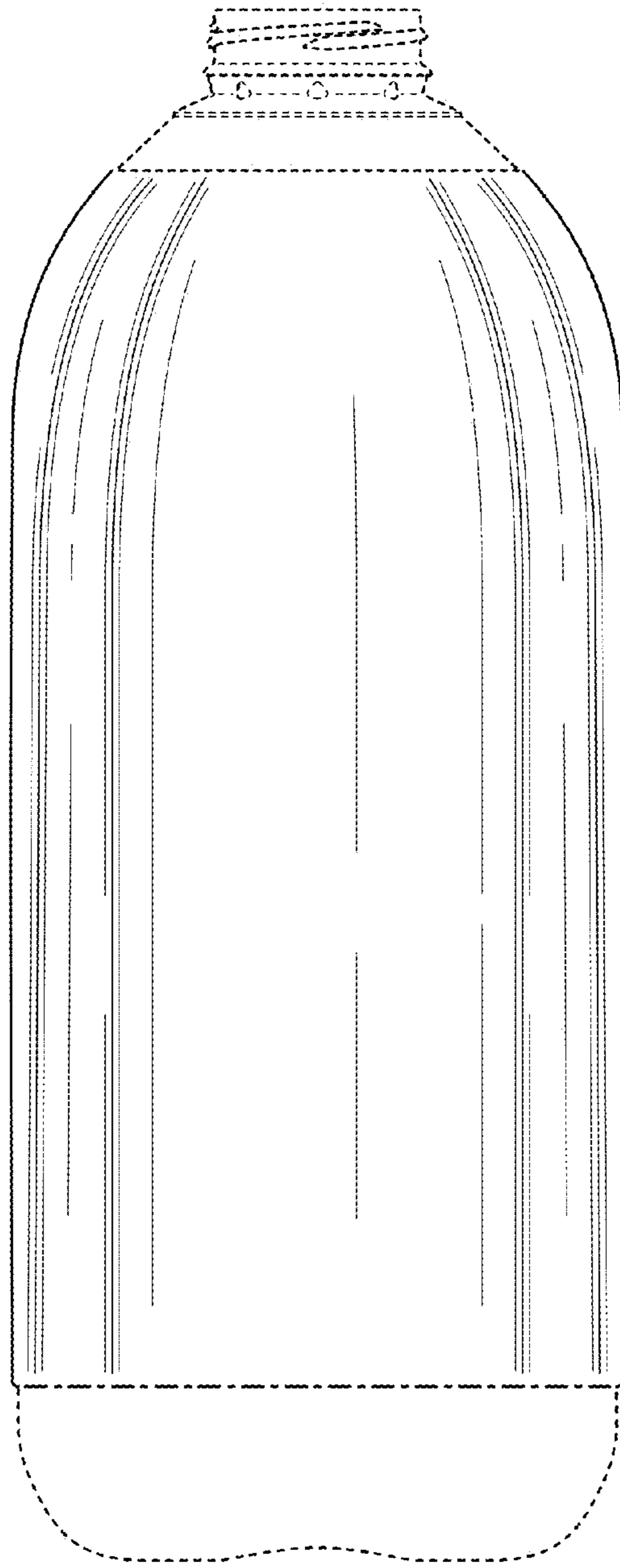

FIG. 4

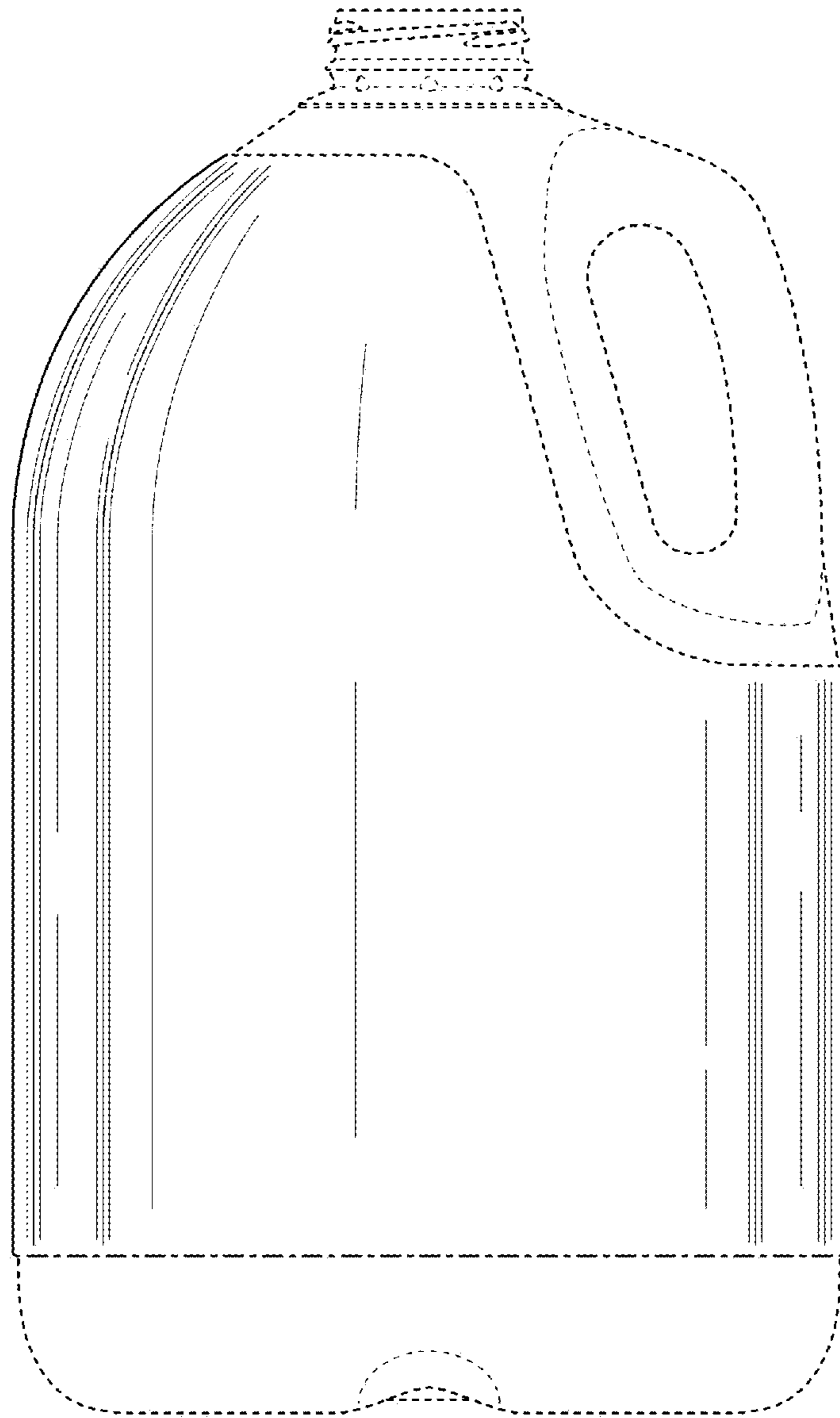

FIG. 5

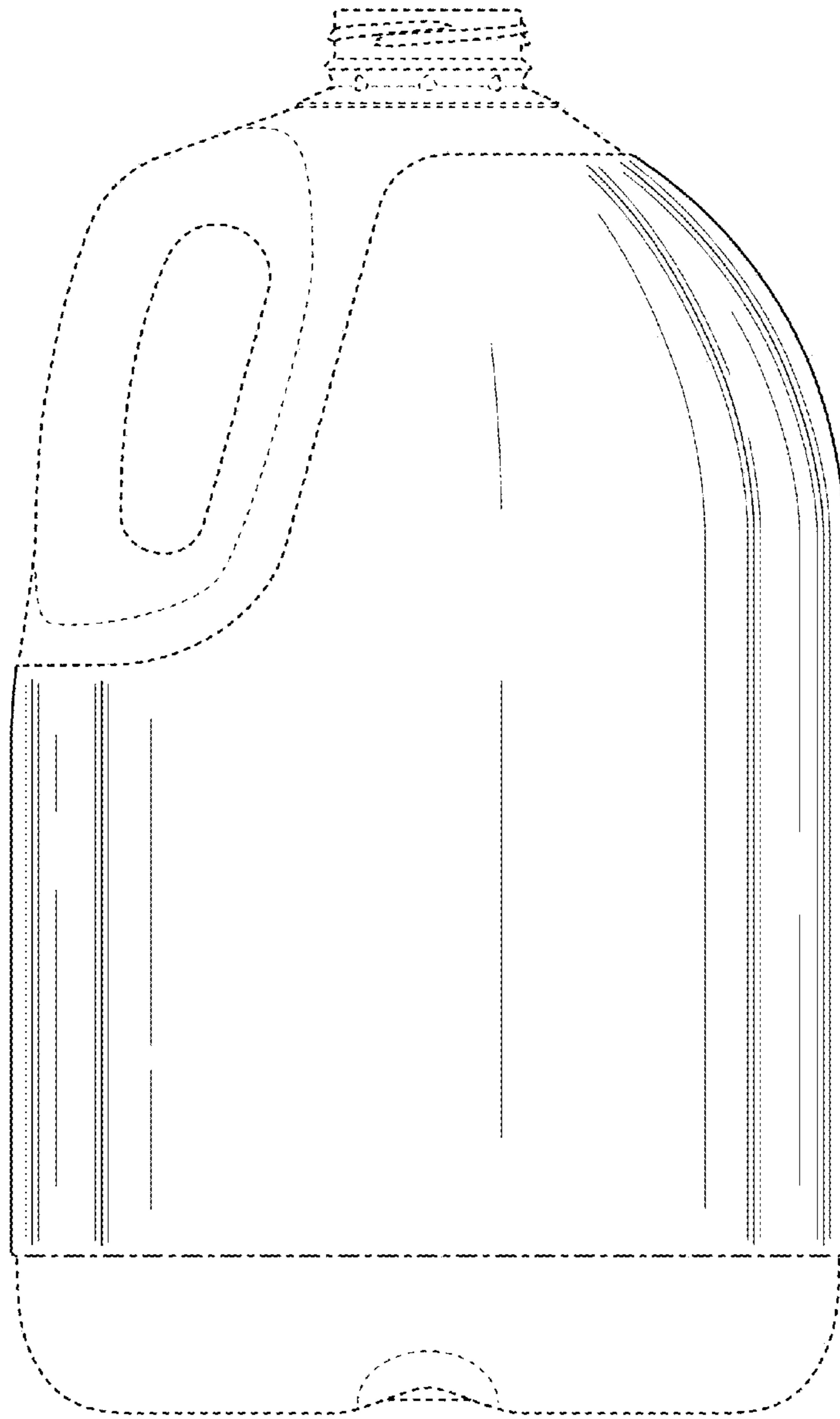

FIG. 6

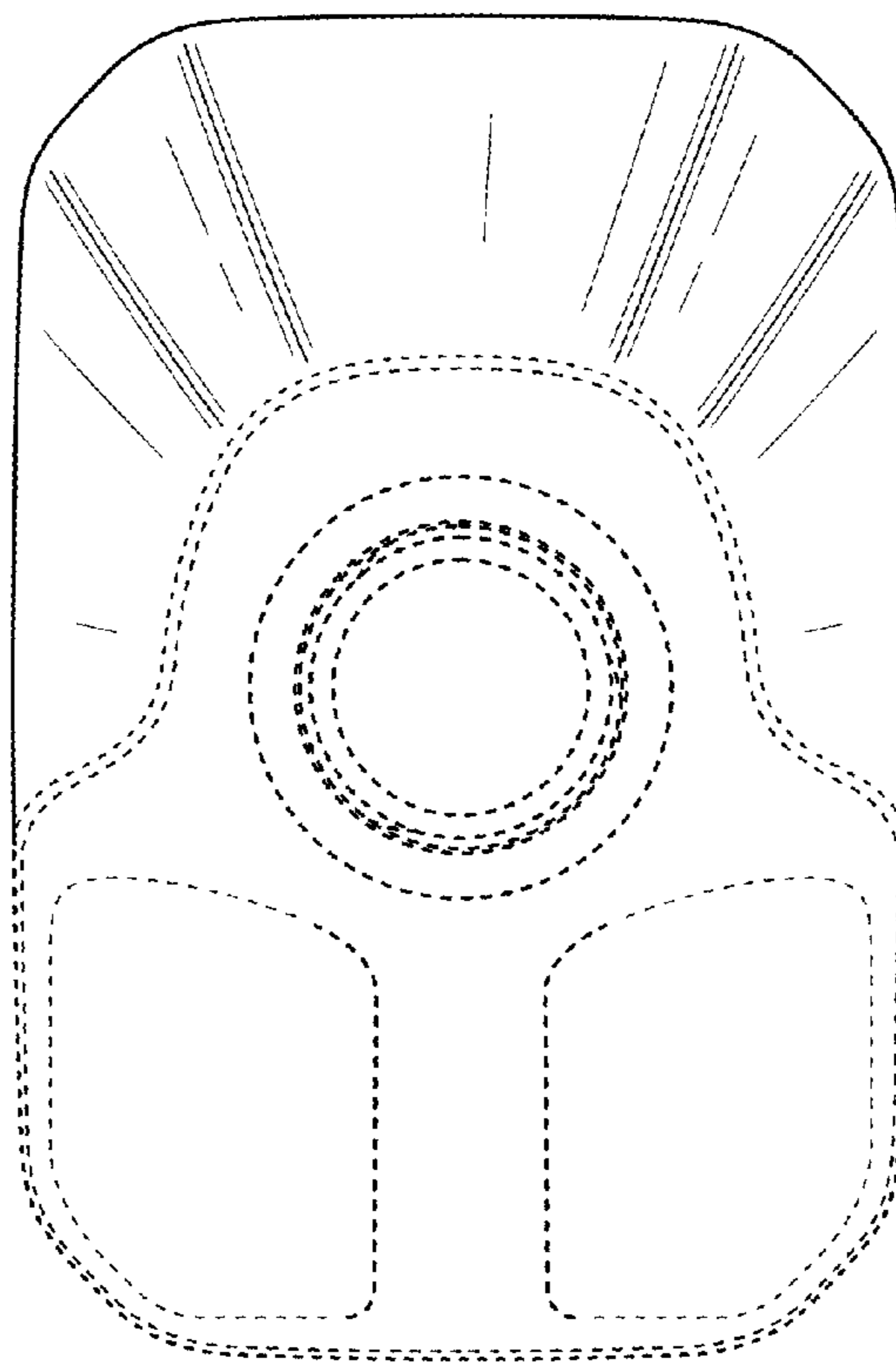

FIG. 7

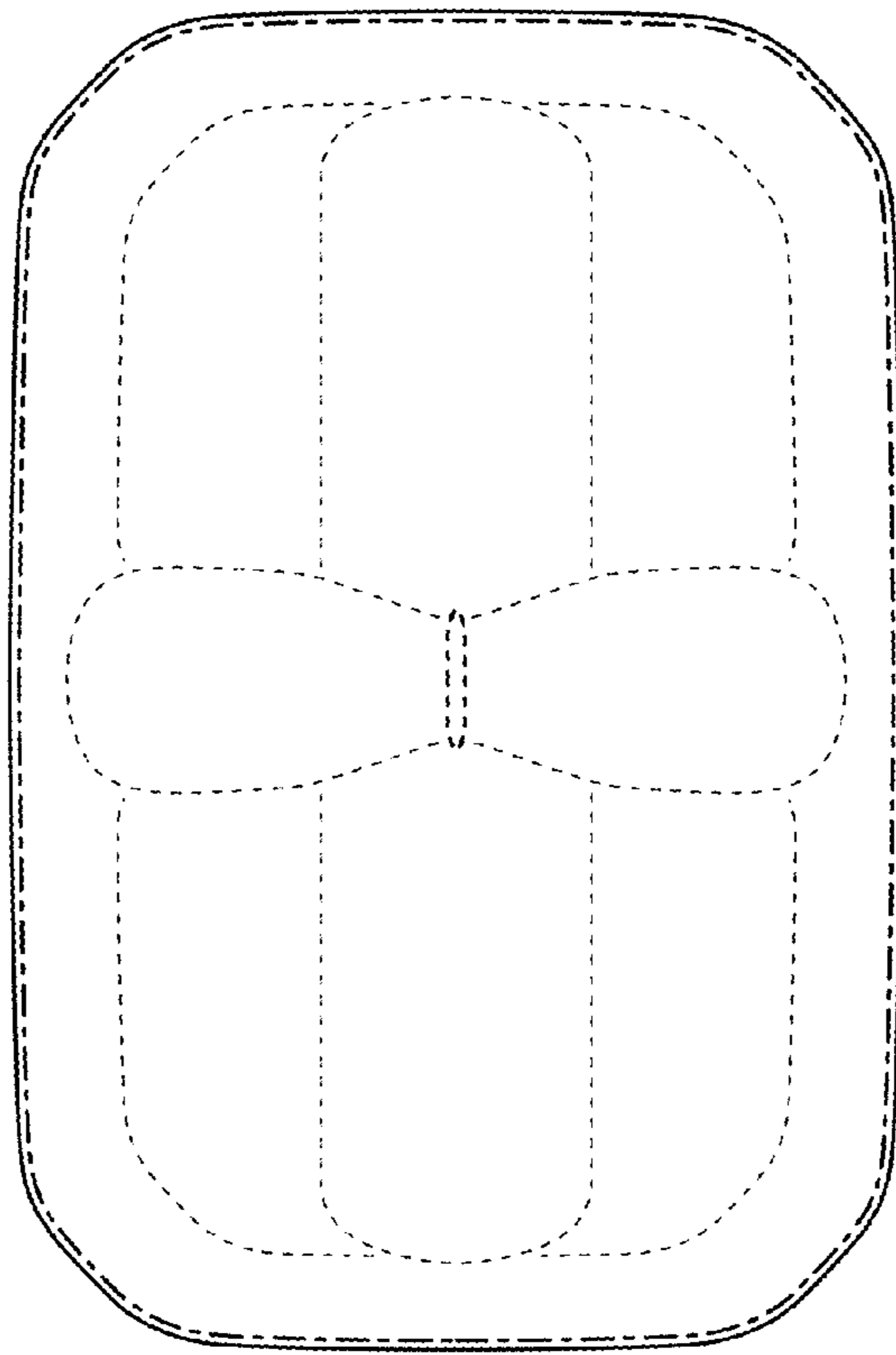

FIG. 8

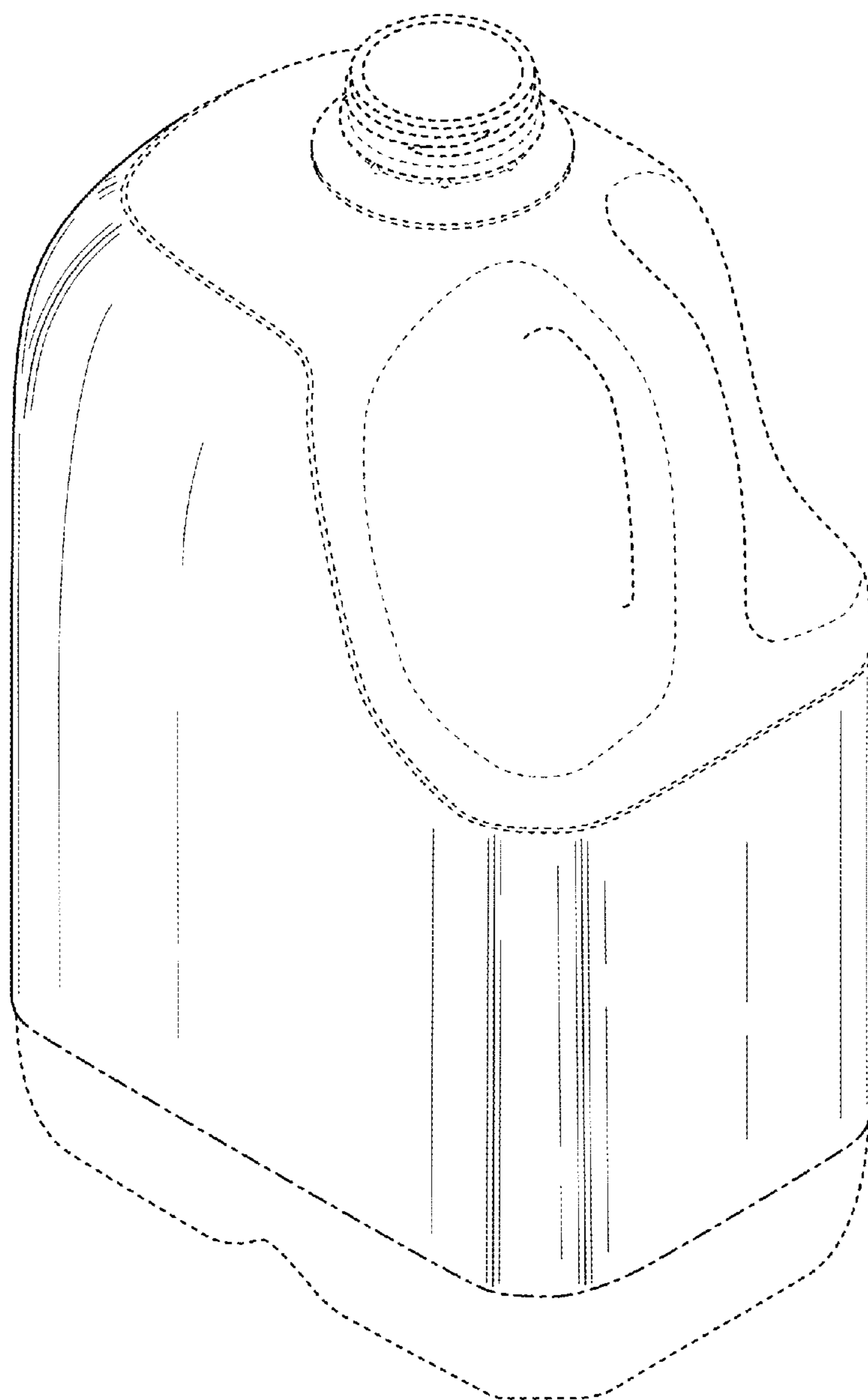

FIG. 9

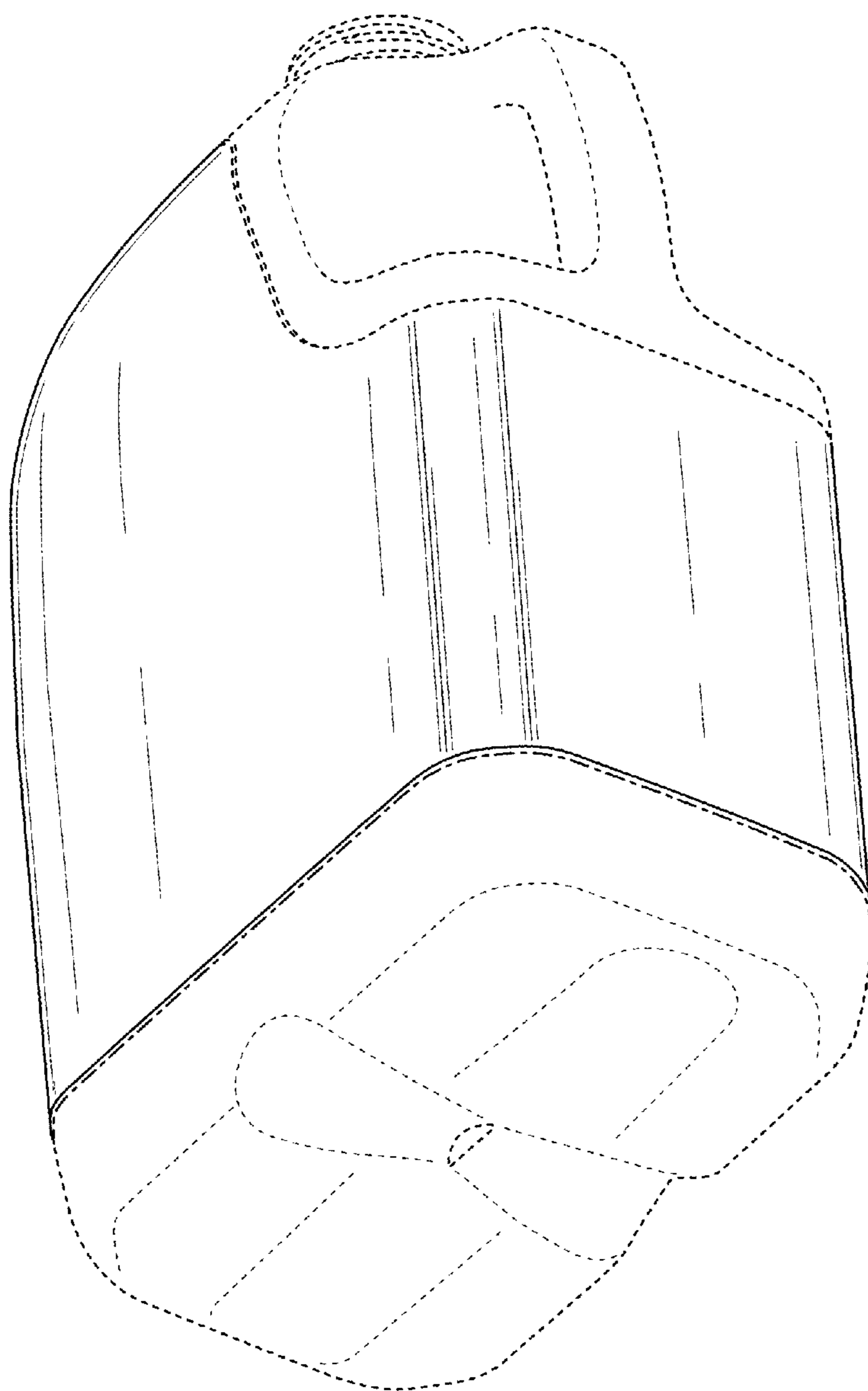

FIG. 10

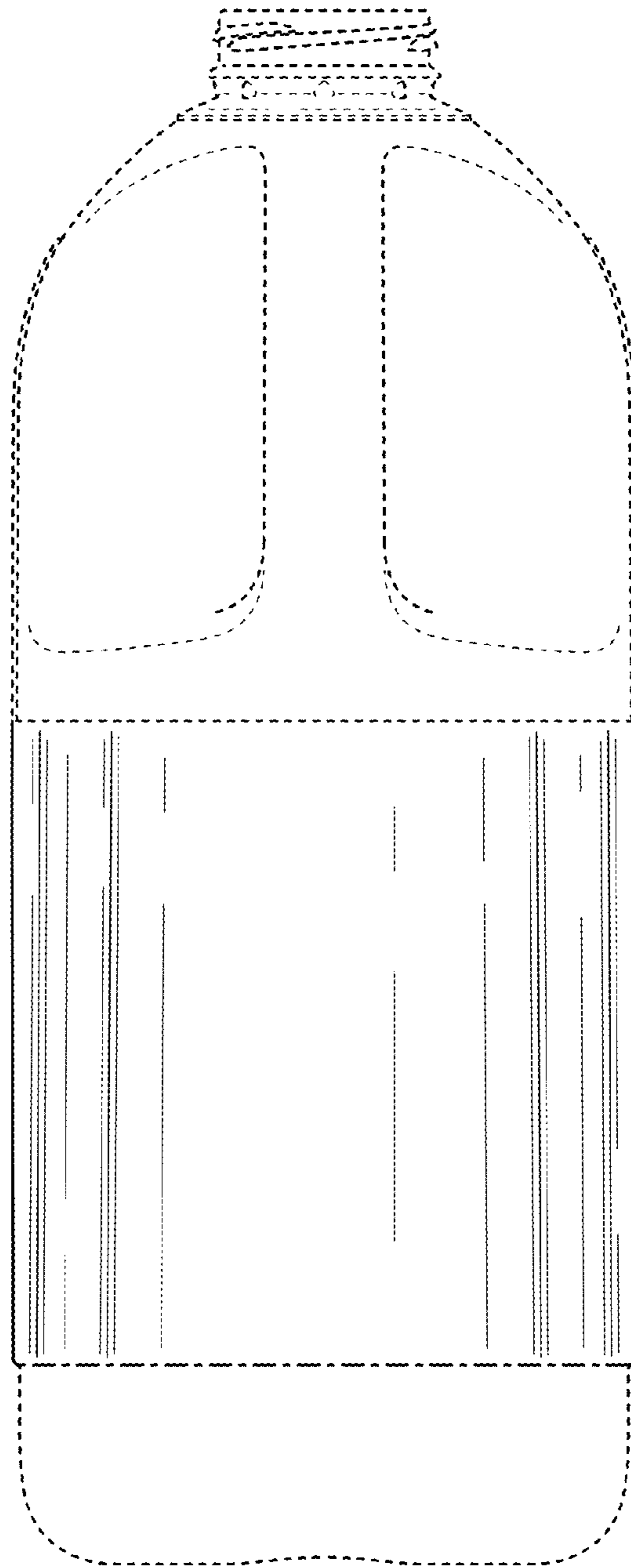

FIG. 11

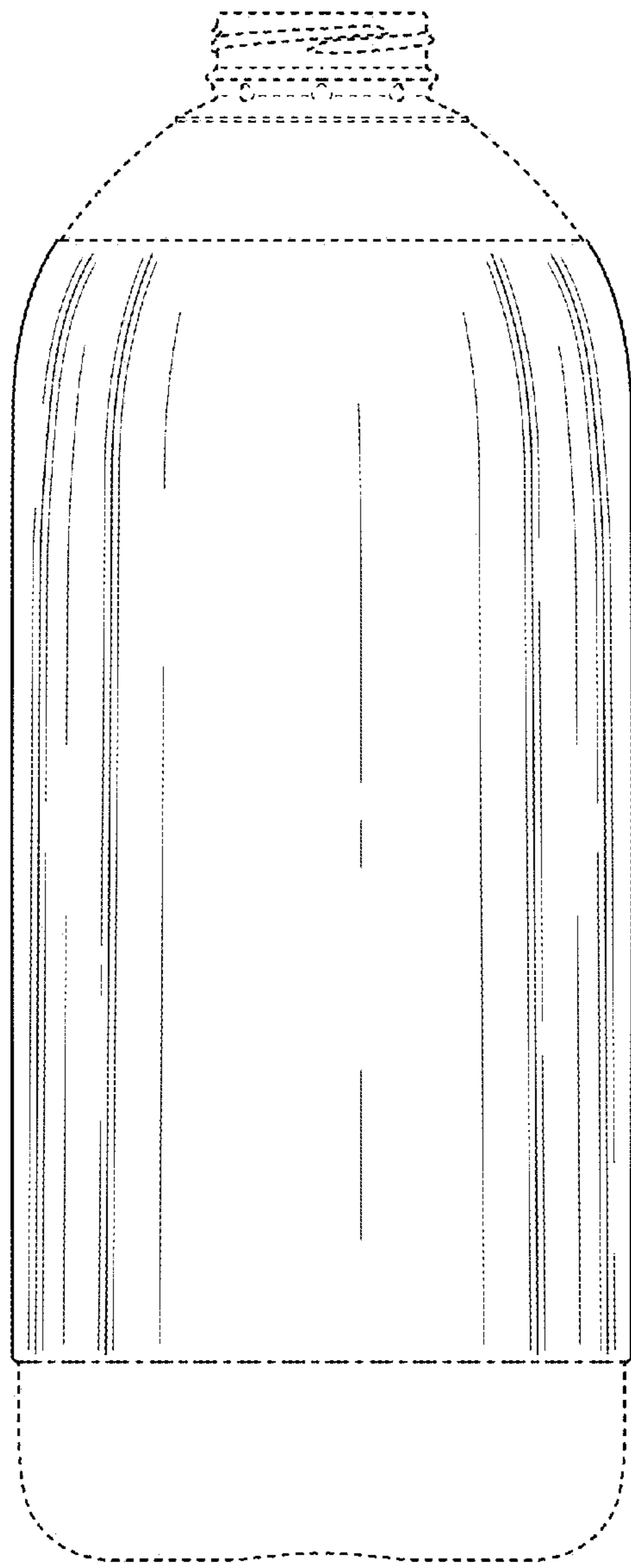

FIG. 12

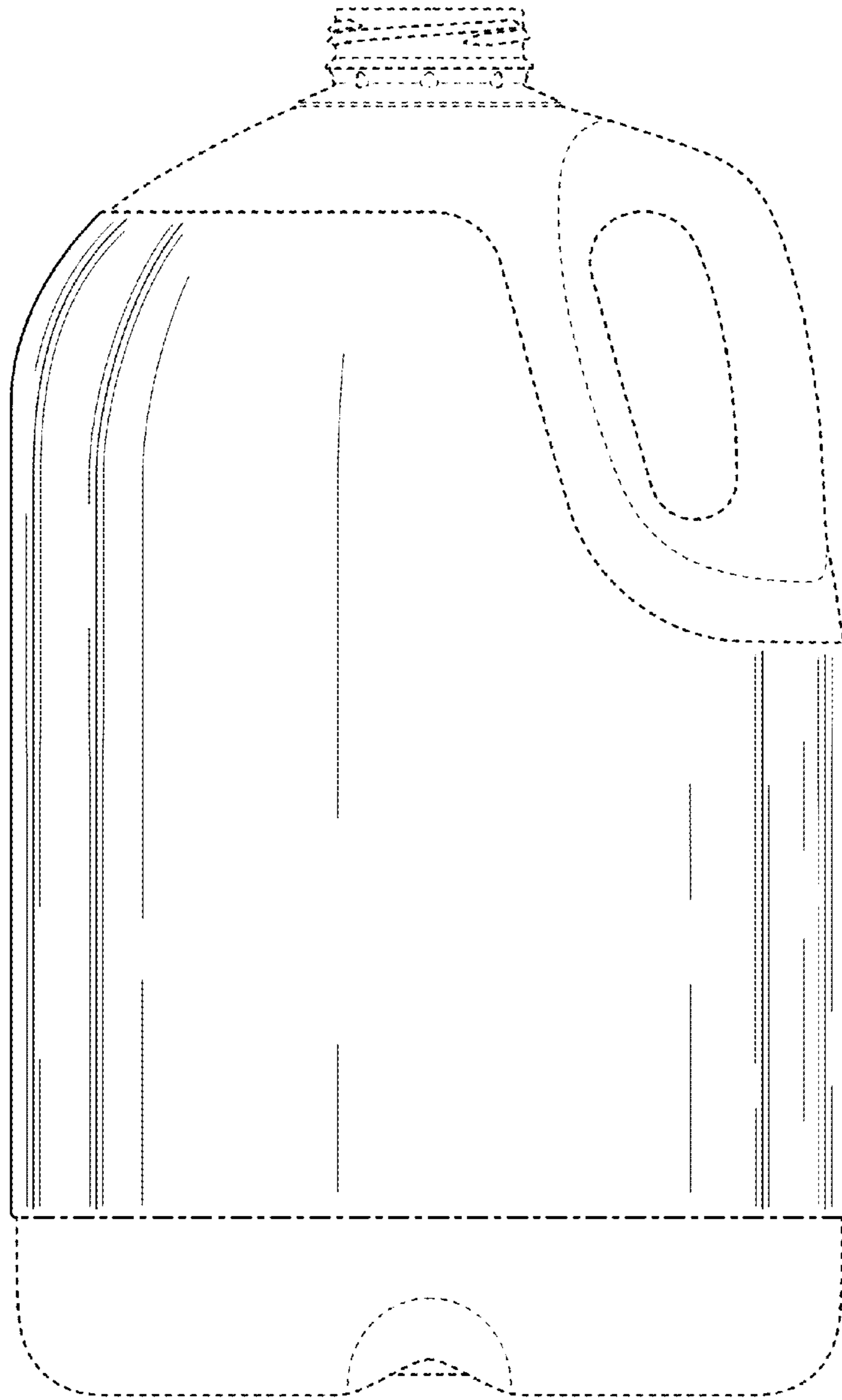

FIG. 13

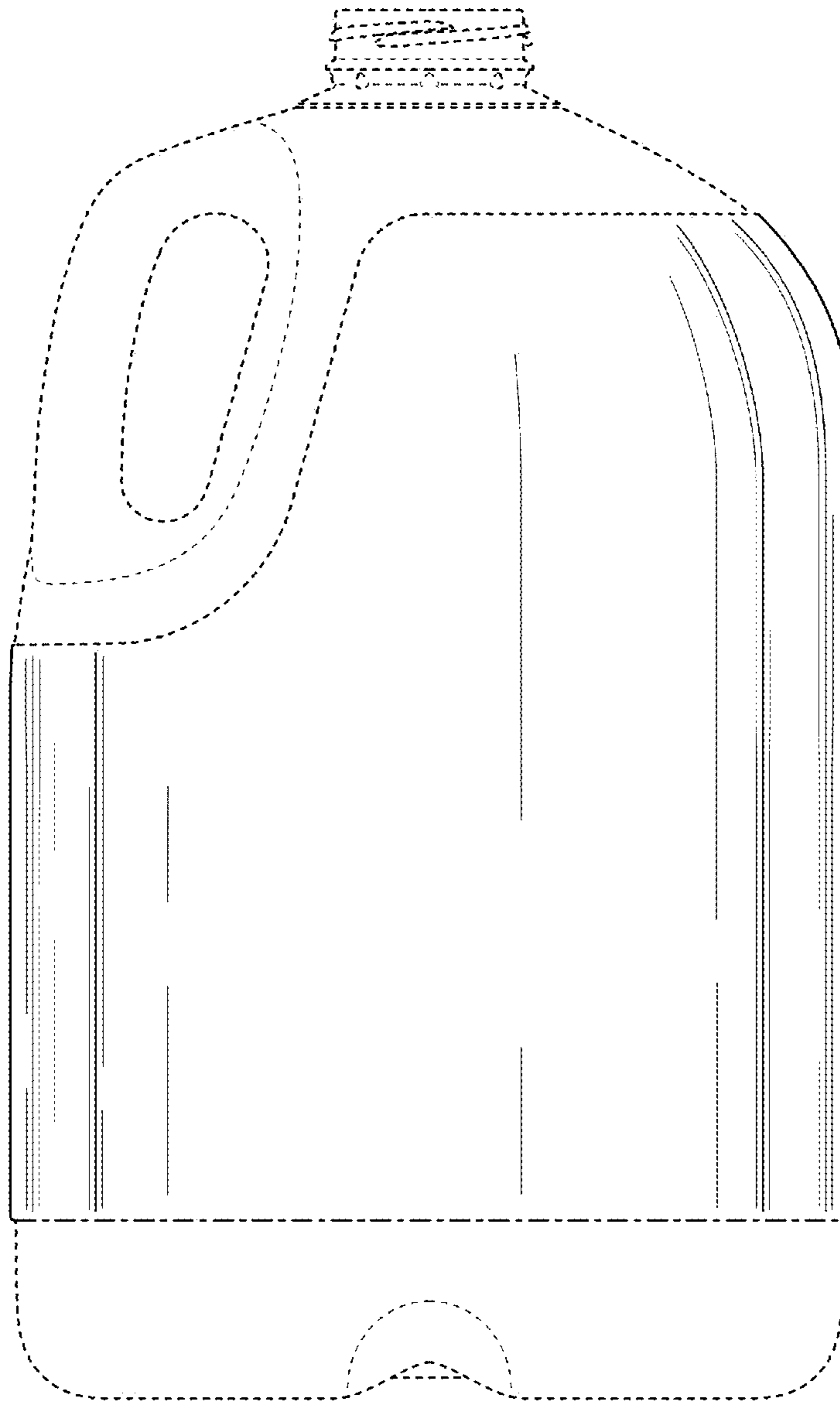

FIG. 14

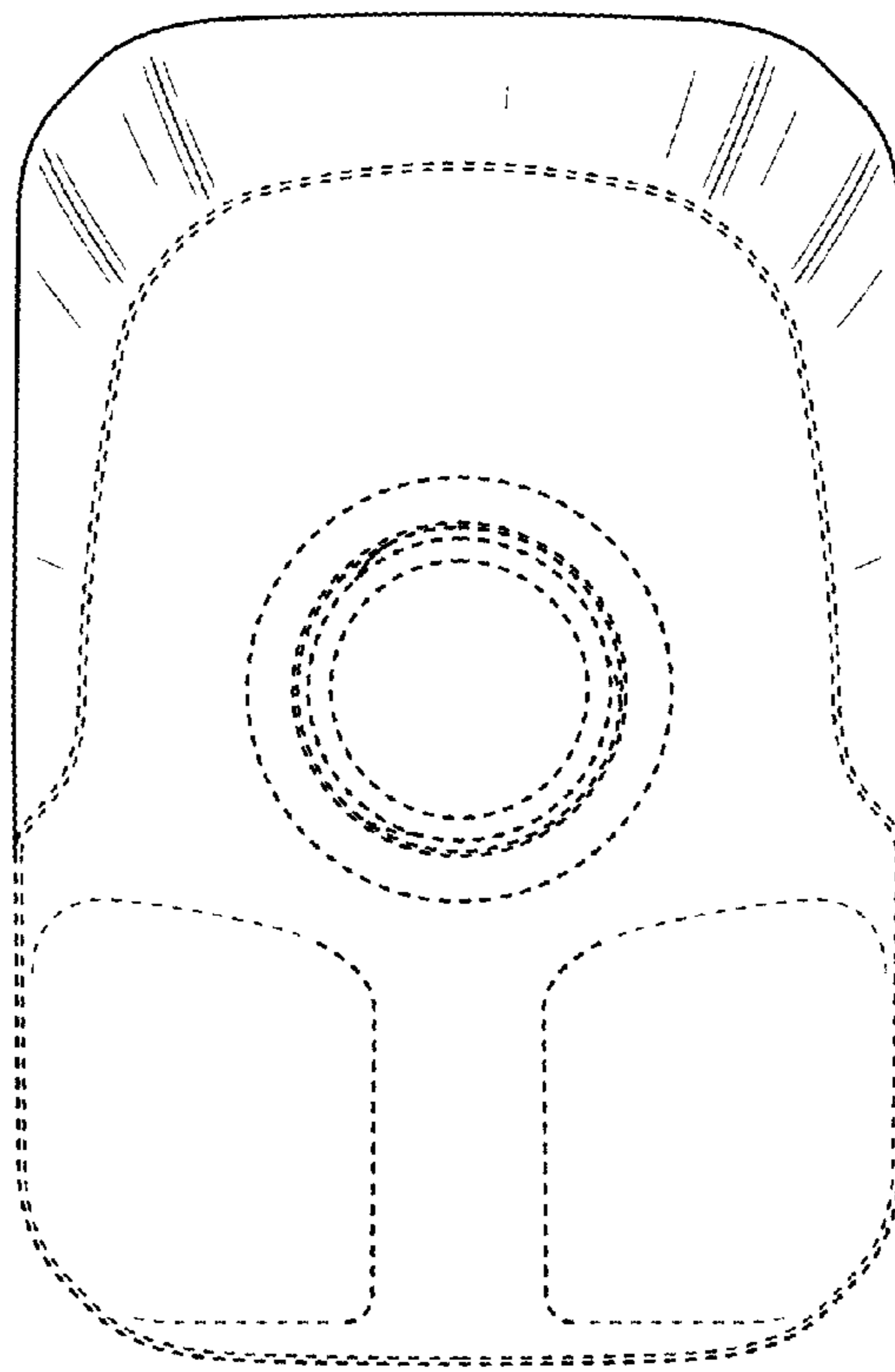

FIG. 15

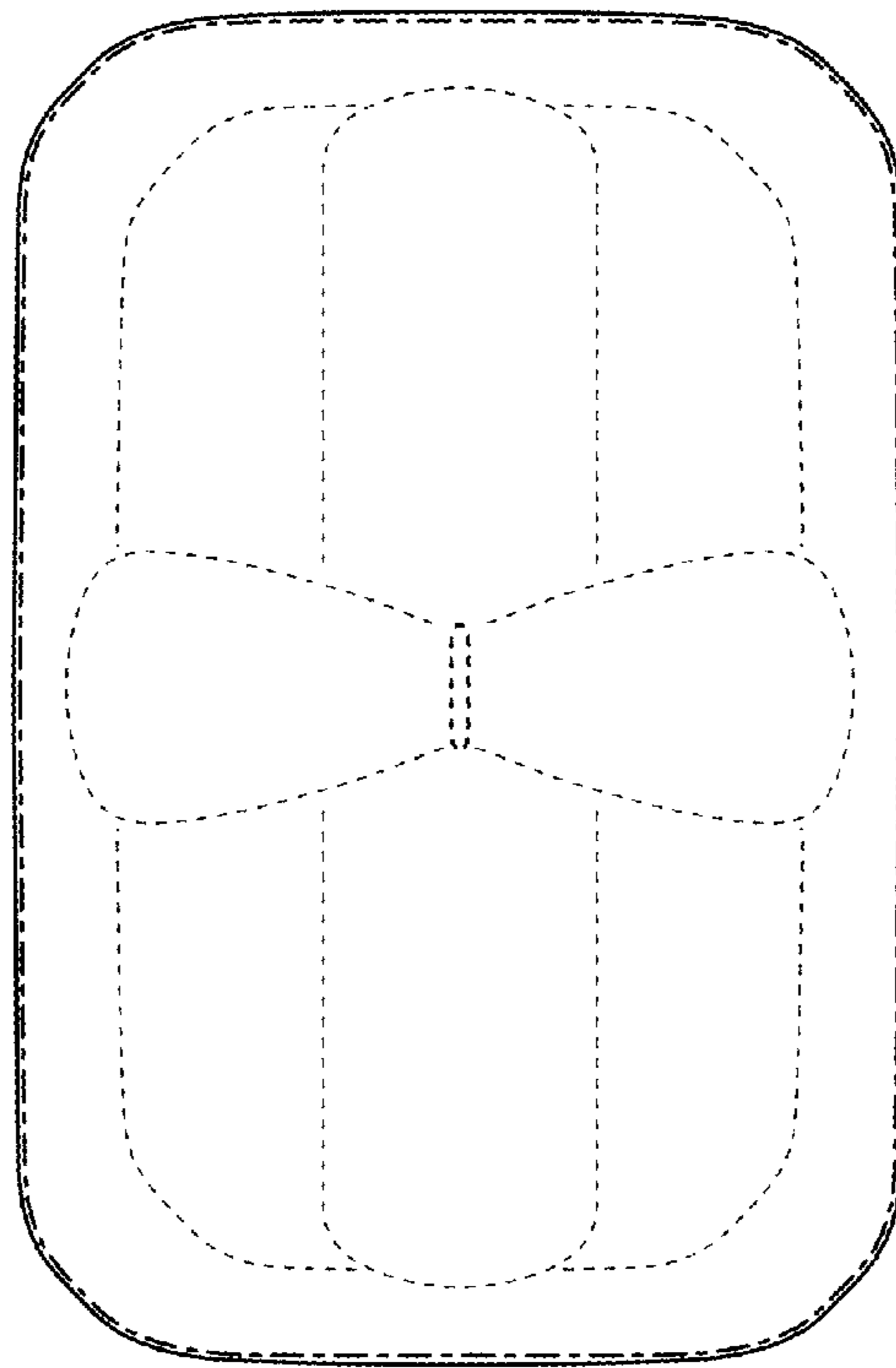

FIG. 16