



US00D763697S

(12) **United States Design Patent**
Lee

(10) **Patent No.:** **US D763,697 S**
(45) **Date of Patent:** **** Aug. 16, 2016**

(54) **COSMETIC CONTAINER**

2200/1009; A45D 2200/1018; A45D
2200/1036; A45D 2200/1045; A45D 34/04;
A45D 34/041

(71) Applicant: **AMOREPACIFIC CORPORATION**,
Seoul (KR)

See application file for complete search history.

(72) Inventor: **Hye-jin Lee**, Seoul (KR)

(56) **References Cited**

(73) Assignee: **AMOREPACIFIC CORPORATION**,
Yongsan-gu, Seoul (KR)

U.S. PATENT DOCUMENTS

(**) Term: **14 Years**

D266,647 S *	10/1982	Plewes	D9/500
D345,918 S *	4/1994	Chevassus	D28/76
D362,187 S *	9/1995	Thompson	D9/500
D411,749 S *	6/1999	Nahum-Albright	D9/529
D416,491 S *	11/1999	Gobe	D28/76
D485,183 S *	1/2004	Lerolle	D9/503
D498,423 S *	11/2004	Kostow	D9/558
D554,518 S *	11/2007	Cornet	D9/558

(21) Appl. No.: **29/503,709**

(22) Filed: **Sep. 29, 2014**

(Continued)

(30) **Foreign Application Priority Data**

FOREIGN PATENT DOCUMENTS

May 9, 2014 (KR) 30-2014-0023012

(51) **LOC (10) Cl.** **09-01**

KR	300522233.0000	*	3/2009
KR	300522233.0001	*	3/2009

(52) **U.S. Cl.**
USPC **D9/549**

(Continued)

(58) **Field of Classification Search**

Primary Examiner — Catherine Tuttle

USPC D9/500–505, 682–694, 723–729, 529,
D9/516, 517, 520, 521, 537–546, 549–575,
D9/418, 434–436; D28/76, 77, 82, 91,
D28/91.1

(74) *Attorney, Agent, or Firm* — East West Law Group;
Heedong Chae

CPC B65D 1/02; B65D 1/0207; B65D 1/0223;
B65D 1/40; B65D 11/02; B65D 11/04;
B65D 11/10; B65D 11/16; B65D 11/20;
B65D 11/24; B65D 13/02; B65D 23/00;
B65D 83/14; B65D 83/20; B65D 83/22;
B65D 83/38; B65D 83/384; B65D 83/40;
B65D 2501/0009; B65D 2501/0018; B65D
2501/0081; A45D 34/00; A45D 34/02;
A45D 2034/002; A45D 2034/005; A45D
2034/007; A45D 34/042; A45D 34/043;
A45D 34/045; A45D 34/046; A45D 34/047;
A45D 34/048; A45D 34/06; A45D 2200/05;
A45D 2200/051; A45D 2200/052; A45D
2200/053; A45D 2200/054; A45D 2200/056;
A45D 2200/057; A45D 2200/10; A45D

(57) **CLAIM**

The ornamental design for a cosmetic container, as shown and described.

DESCRIPTION

FIG. 1 is a perspective view of a cosmetic container showing my new design;
FIG. 2 is a front elevational view thereof;
FIG. 3 is a rear elevational view thereof;
FIG. 4 is a left side elevational view thereof;
FIG. 5 is a right side elevational view thereof;
FIG. 6 is a top plan view thereof; and,
FIG. 7 is a bottom plan view thereof.

1 Claim, 7 Drawing Sheets

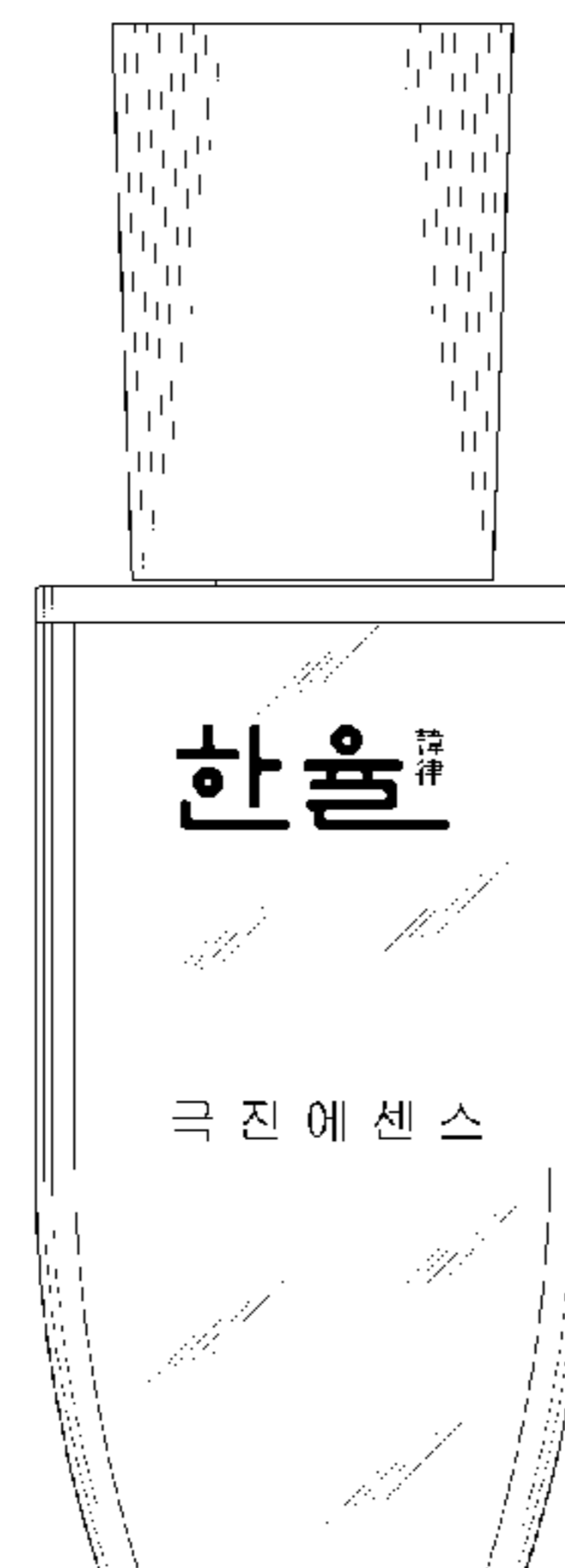
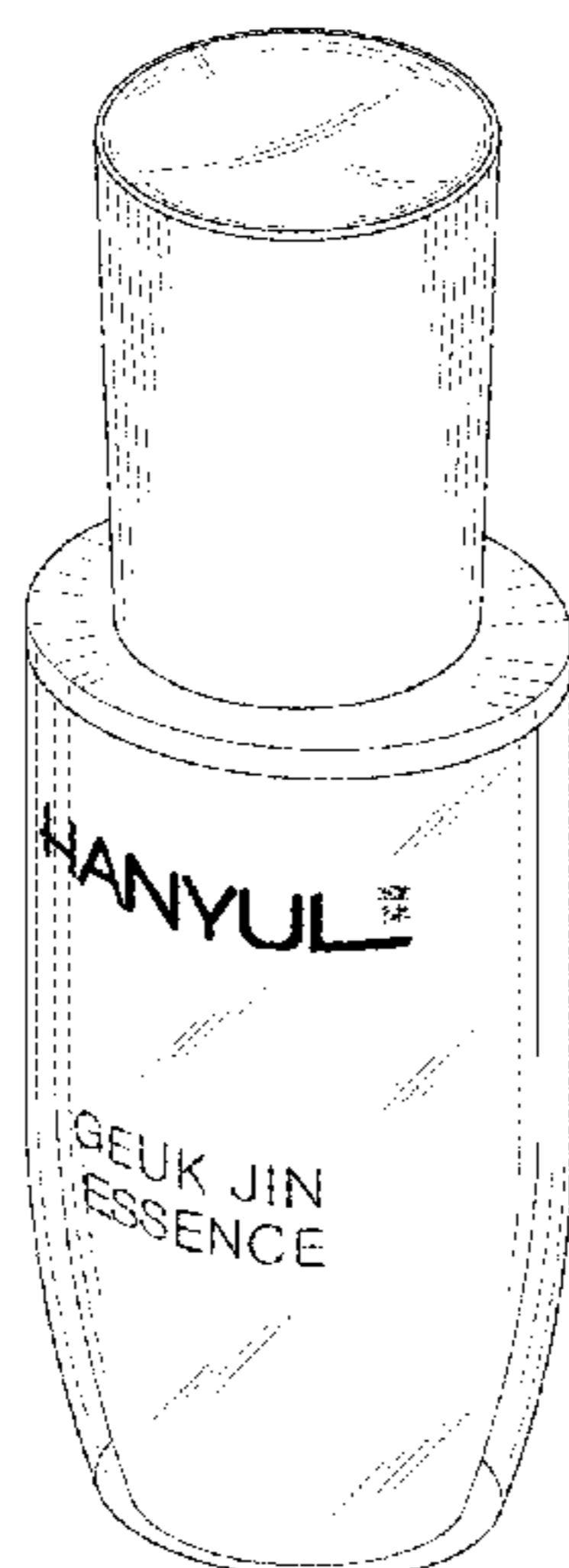

(56)

References Cited

U.S. PATENT DOCUMENTS

D570,707 S * 6/2008 Blasko D9/689
D631,356 S * 1/2011 Barsoumian D9/500
D639,180 S * 6/2011 Shiota D9/689
D658,068 S * 4/2012 Nawrocki D9/549
D658,076 S * 4/2012 McCoy D9/723
D658,507 S * 5/2012 McCoy D9/723
D682,709 S * 5/2013 Wang D9/689
D683,238 S * 5/2013 You D9/688
D696,121 S * 12/2013 Jung D9/503
D711,748 S * 8/2014 Hwang D9/691
D715,157 S * 10/2014 In D9/691

D721,283 S * 1/2015 Lawrance D9/689
2015/0020836 A1* 1/2015 Ramet A45D 34/045
132/200

FOREIGN PATENT DOCUMENTS

KR 300550664.0000 * 1/2010
KR 300628070.0000 * 1/2012
KR 300645235.0000 * 5/2013
KR 300726356.0000 * 1/2014
KR 300733639.0000 * 3/2014
KR 300733641.0000 * 3/2014
WO D048054-014 * 8/1999

* cited by examiner

FIG. 1

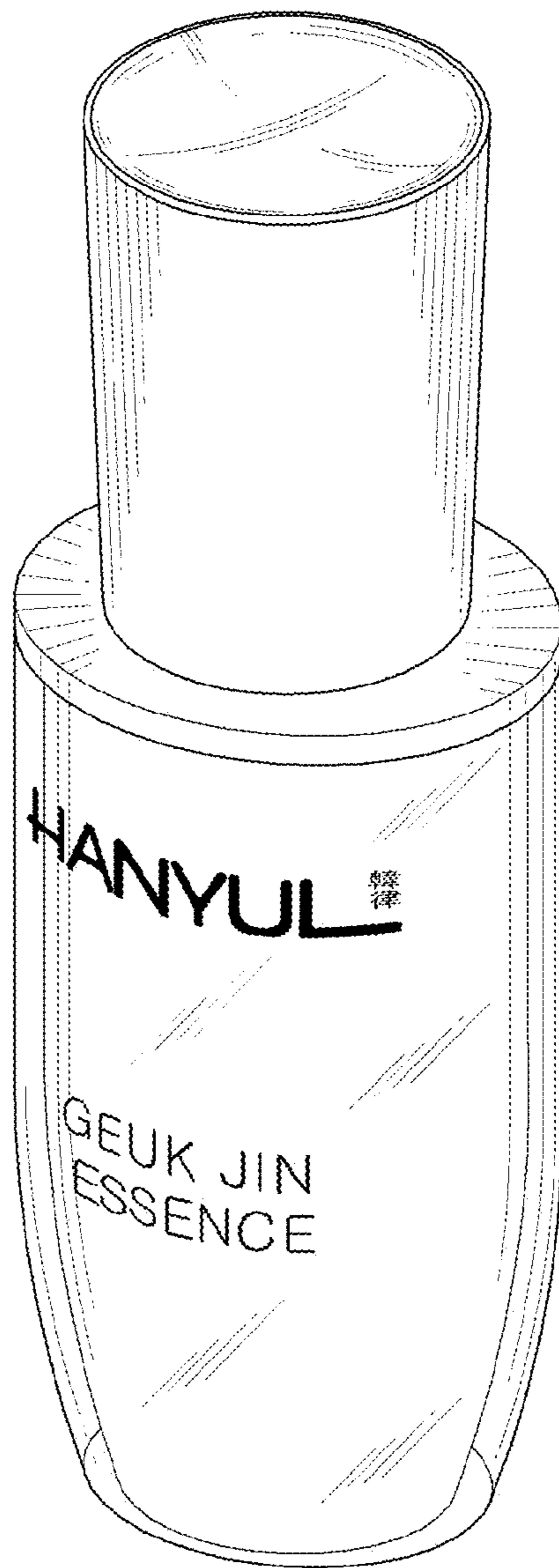

FIG. 2



FIG. 3

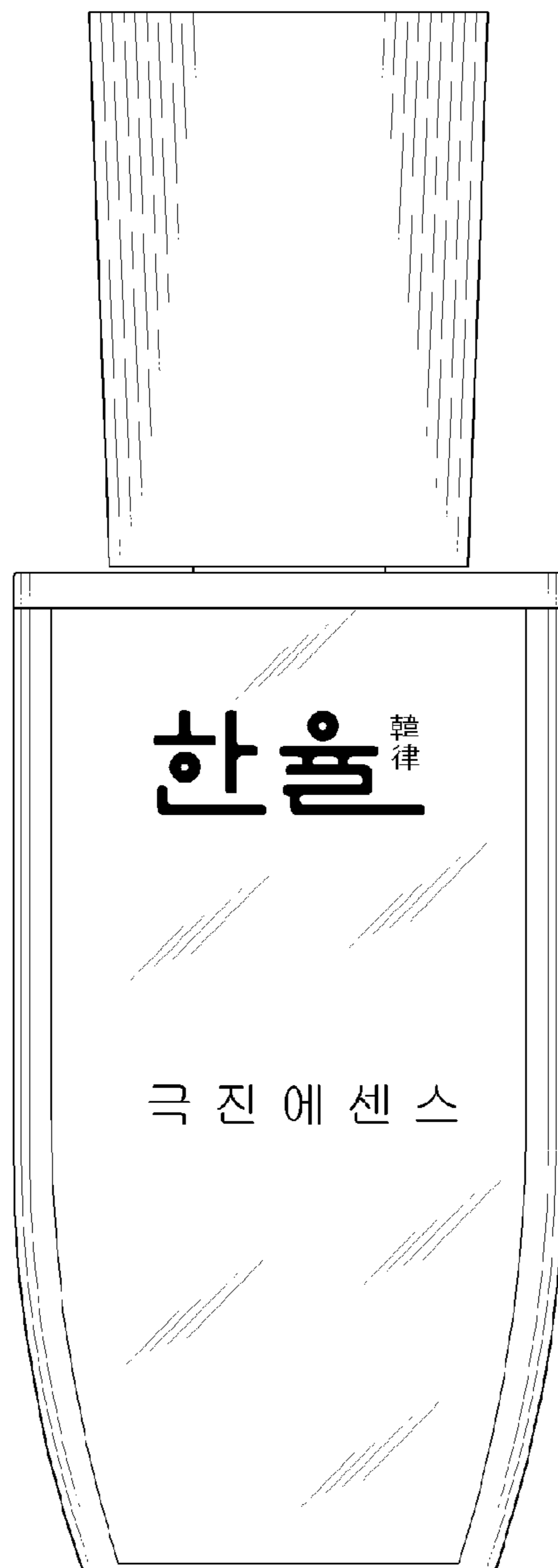

FIG. 4

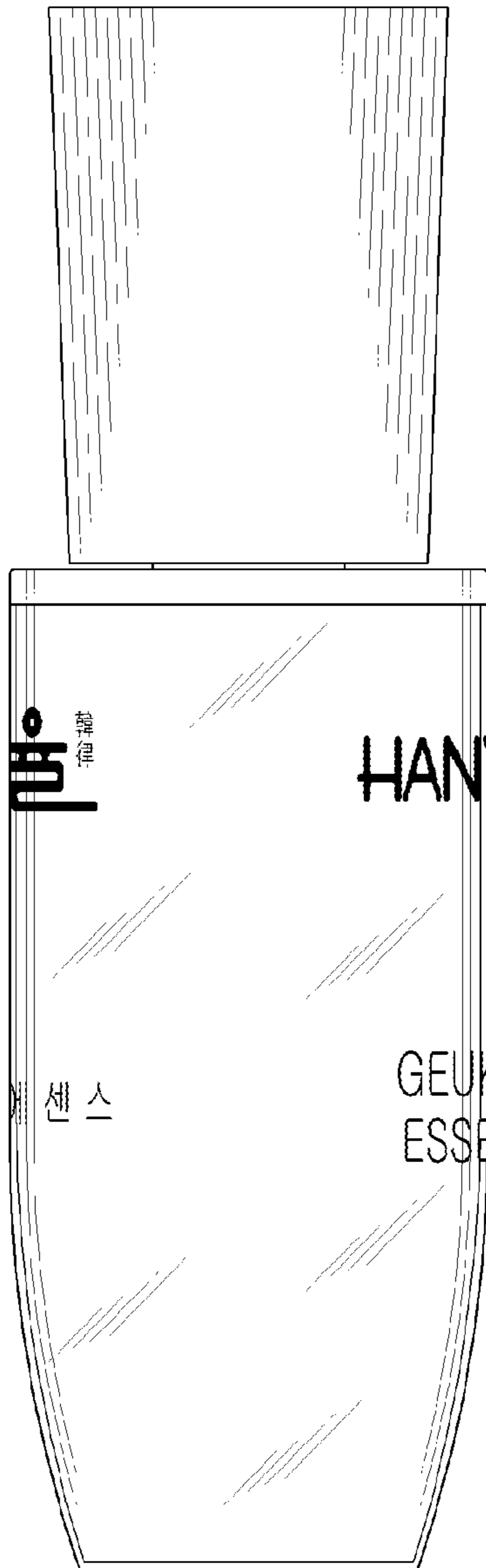

FIG. 5

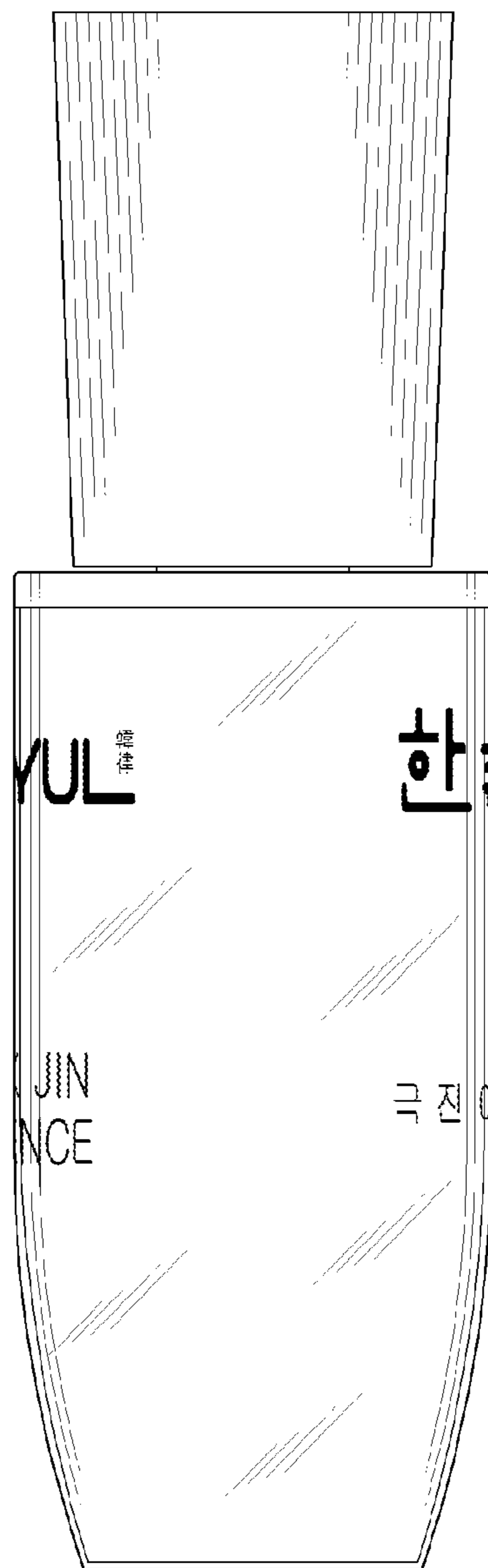

FIG. 6

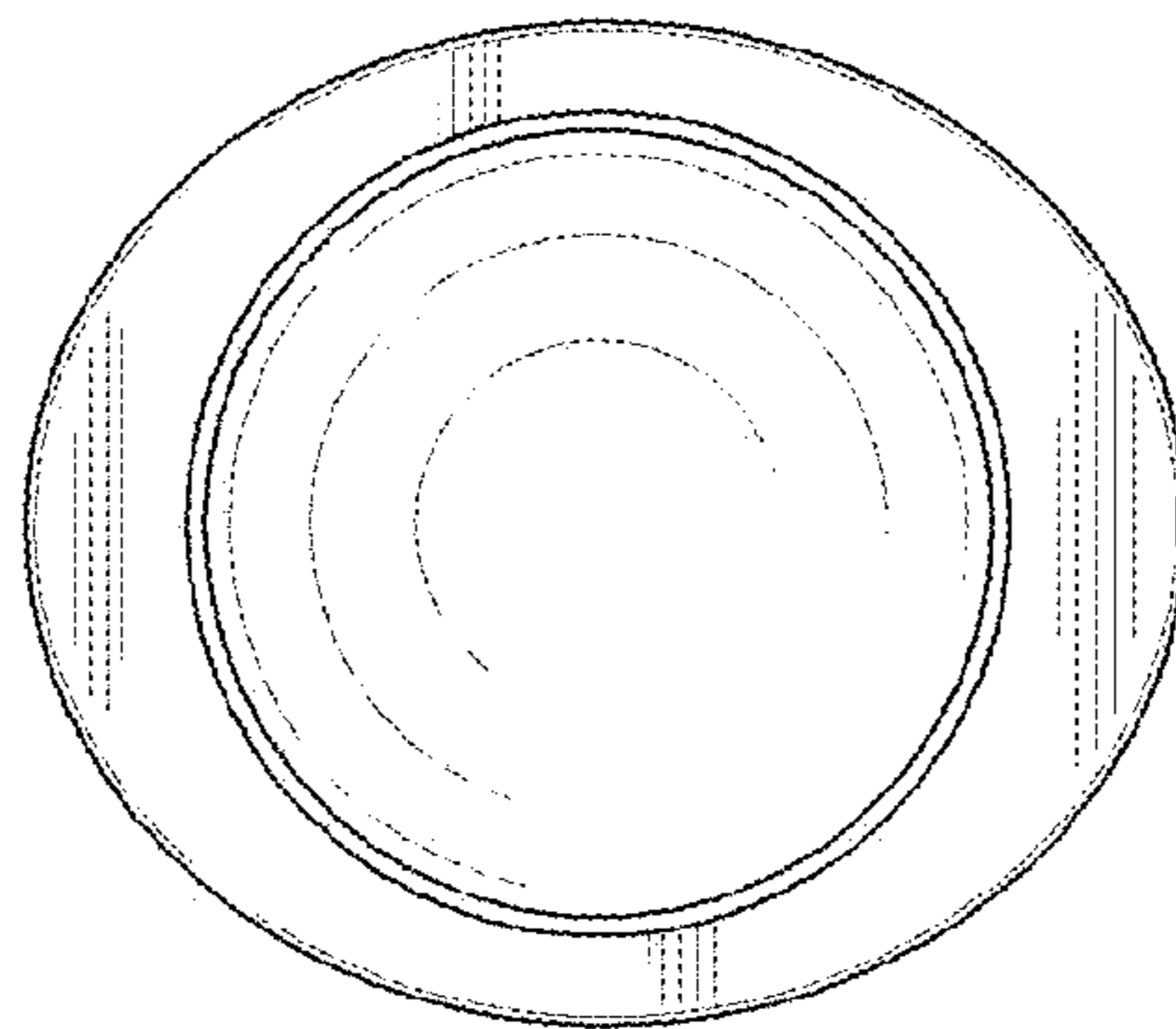

FIG. 7

