



US00D763654S

(12) **United States Design Patent**
Chung et al.

(10) **Patent No.:** **US D763,654 S**
(45) **Date of Patent:** **** Aug. 16, 2016**

(54) **DOOR HANDLE FOR OVEN RANGE**

(56) **References Cited**

(71) Applicant: **LG ELECTRONICS INC.**, Seoul (KR)

U.S. PATENT DOCUMENTS

(72) Inventors: **Jae Hun Chung**, Seoul (KR); **In Hwan Ryu**, Seoul (KR); **Sang Woo Kim**, Seoul (KR)

| | | | | | | |
|----------|---|---|---------|-------------|-------|--------|
| D552,959 | S | * | 10/2007 | Gilboe | | D8/317 |
| D568,100 | S | * | 5/2008 | Jeon | | D7/402 |
| D570,646 | S | * | 6/2008 | Jeon | | D7/402 |
| D572,109 | S | * | 7/2008 | Busalt | | D8/316 |
| D572,110 | S | * | 7/2008 | Busalt | | D8/316 |
| D572,111 | S | * | 7/2008 | Busalt | | D8/316 |
| D577,567 | S | * | 9/2008 | Crookshanks | | D8/316 |
| D580,698 | S | * | 11/2008 | Kim | | D7/348 |
| D606,839 | S | * | 12/2009 | Urquiola | | D8/316 |
| D612,677 | S | * | 3/2010 | Jeon | | D15/89 |
| D614,013 | S | * | 4/2010 | Saubert | | D15/89 |
| D668,106 | S | * | 10/2012 | Borjesson | | D7/405 |
| D728,300 | S | * | 5/2015 | Borjesson | | D7/349 |
| D728,309 | S | * | 5/2015 | Borjesson | | D7/405 |

(73) Assignee: **LG Electronics Inc.**, Seoul (KR)

(**) Term: **14 Years**

(21) Appl. No.: **29/525,683**

(22) Filed: **May 1, 2015**

(30) **Foreign Application Priority Data**

Dec. 9, 2014 (KR) 30-2014-0060024

(51) **LOC (10) Cl.** **08-06**

(52) **U.S. Cl.**
USPC **D8/315**

(58) **Field of Classification Search**
USPC D32/1-3, 6, 25, 28, 29, 34, 24;
D23/226, 255, 271, 259-260, 268,
D23/381; 312/109, 237 A; 134/56 R, 57 R,
134/57 D, 57 DL, 56 D, 58 R, 58 D, 58 DL,
134/25.2, 184; 68/3 R, 13 R, 27-28,
68/213-214, 232; D8/300-303, 315-317;
D15/89, 79; D6/327, 513, 522-523,
D6/545-546, 571; D7/331-332, 338-340,
D7/348-350.1, 351, 354, 393, 405; 16/436
CPC ... Y10T 16/4576; Y10T 16/501; Y10T 16/86;
Y10T 16/469; Y10T 16/44; Y10T 16/458;
Y10T 16/498; Y10T 16/476; Y10T 16/459;
Y10T 16/466; Y10T 16/4713; Y10T 16/4644;
Y10T 16/513; Y10T 16/509; Y10T 16/473;
Y10T 16/462

See application file for complete search history.

(Continued)

Primary Examiner — Ian Simmons

Assistant Examiner — Harold Blackwell, II

(74) *Attorney, Agent, or Firm* — Birch, Stewart, Kolasch & Birch, LLP

(57) **CLAIM**

We claim the ornamental design for a door handle for oven range, as shown and described.

DESCRIPTION

FIG. 1 is a perspective view of a door handle for oven range showing our new design;
FIG. 2 is a front elevation view thereof;
FIG. 3 is a rear elevation view thereof;
FIG. 4 is a left-side elevation view thereof;
FIG. 5 is a right-side elevation view thereof;
FIG. 6 is a top plan view thereof;
FIG. 7 is a bottom plan view thereof; and,
FIG. 8 is a perspective view showing an illustration of use thereof.
The broken lines in the drawing figures are included for the purpose of illustrating environment and form no part of the claimed design.

1 Claim, 5 Drawing Sheets

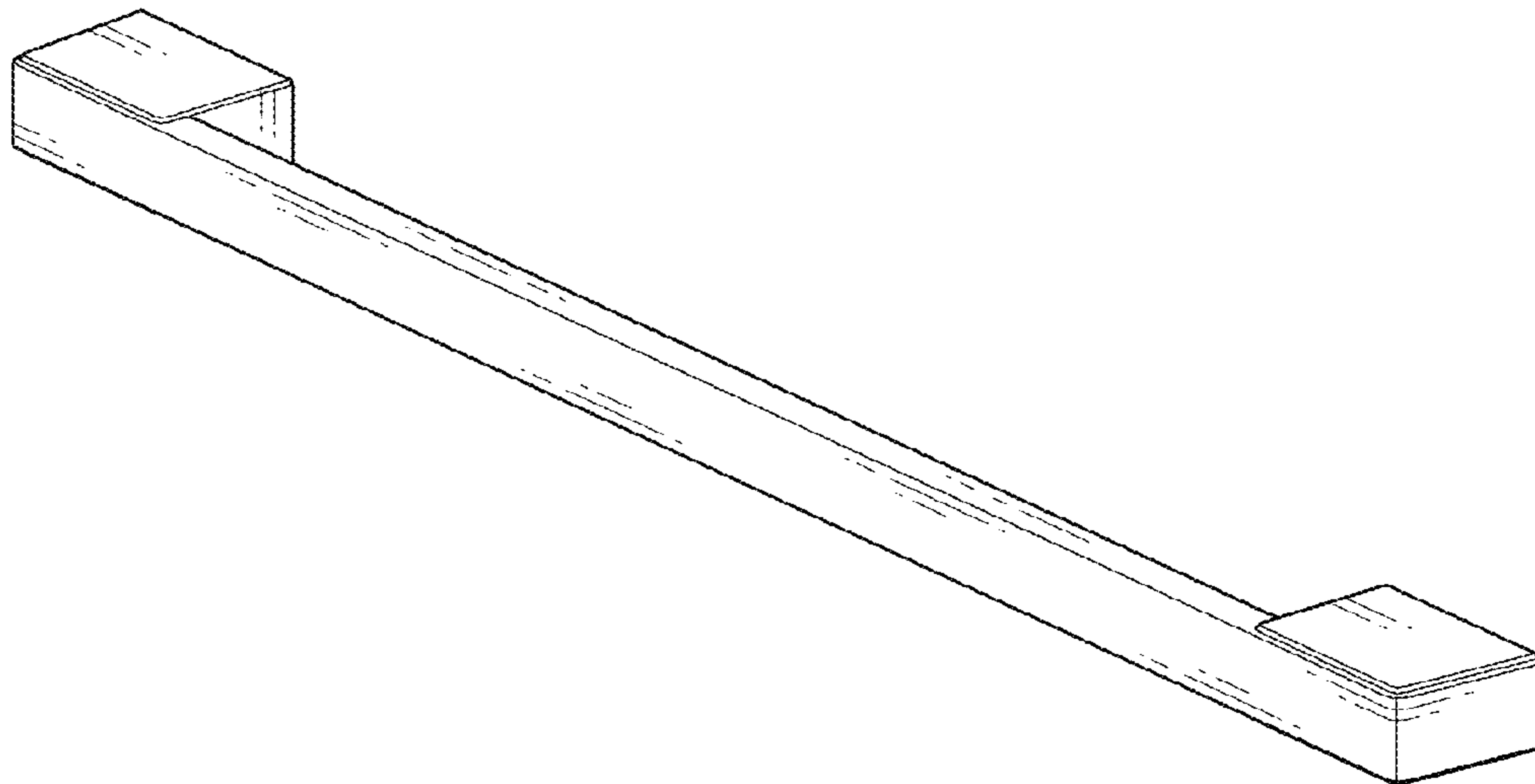

US D763,654 S

Page 2

(56)

References Cited

U.S. PATENT DOCUMENTS

| | | | | | | | |
|--------------|---------|-------------------|--------|-------------------|--------|-------------------|-----------------------|
| D732,249 S * | 6/2015 | Roberson | D32/3 | D747,948 S * | 1/2016 | Funnell, II | D8/315 |
| D736,055 S * | 8/2015 | Funnell, II | D8/315 | D748,424 S * | 2/2016 | Funnell, II | D7/348 |
| D741,104 S * | 10/2015 | Funnell, II | D7/348 | D749,393 S * | 2/2016 | Lee | D15/89 |
| D747,912 S * | 1/2016 | Funnell, II | D7/348 | D750,414 S * | 3/2016 | Funnell, II | D7/348 |
| | | | | 2003/0056334 A1 * | 3/2003 | Finkelstein | F24C 15/024 16/436 |

* cited by examiner

FIG. 1

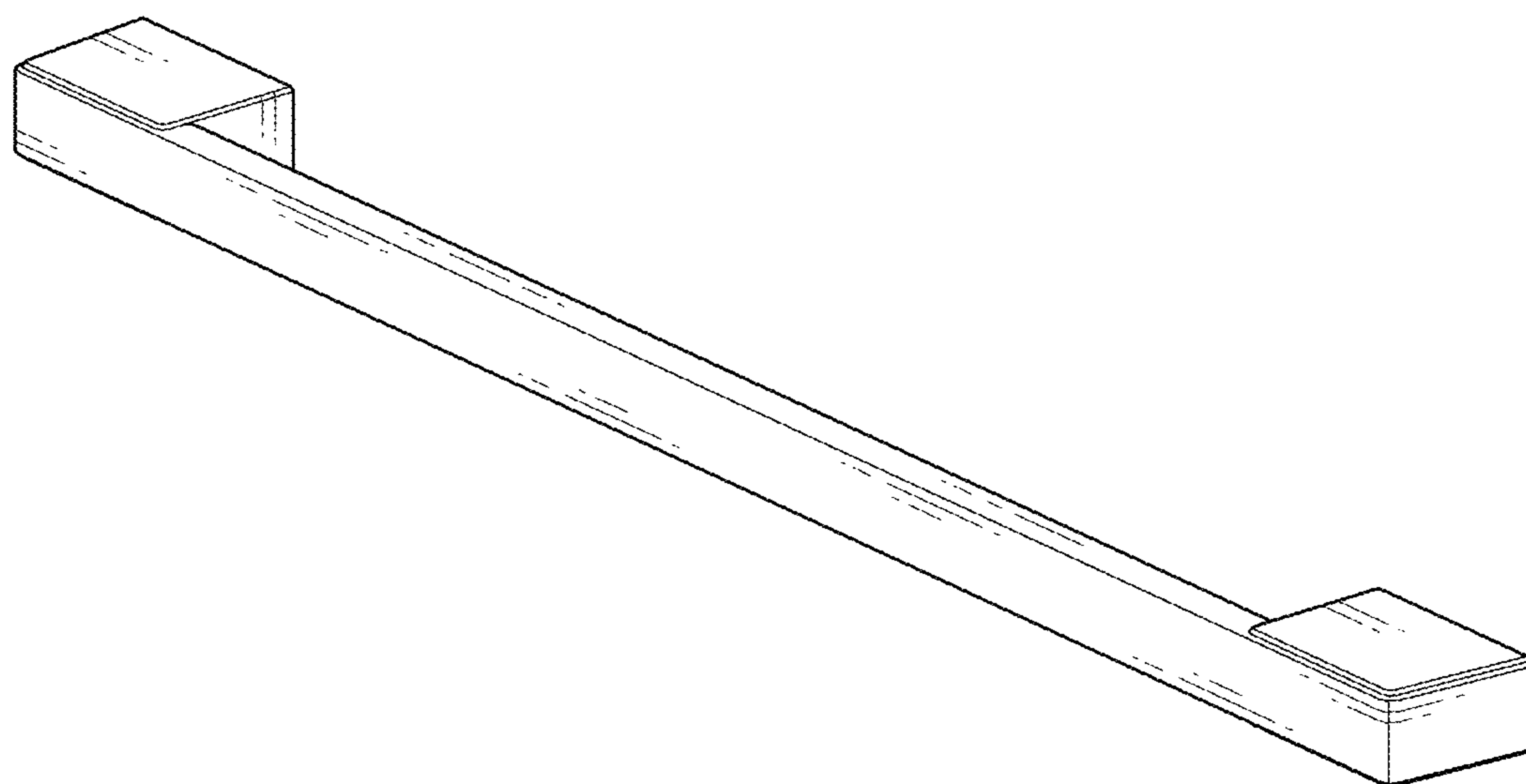

FIG. 2

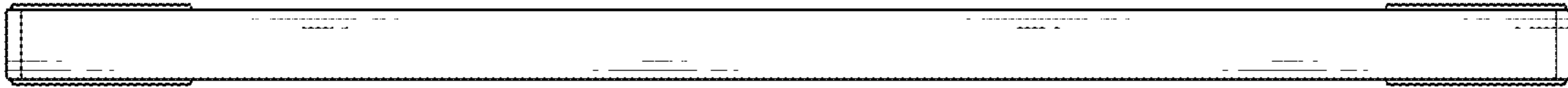

FIG. 3



FIG. 4

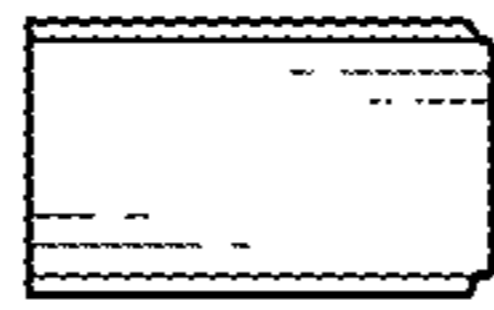

FIG. 5

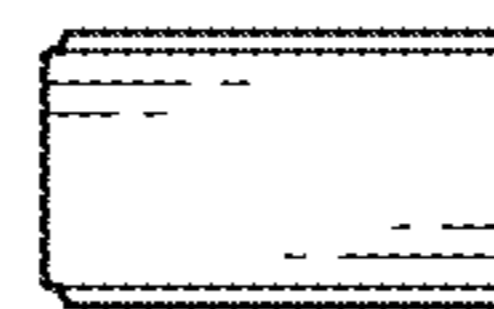

FIG. 6

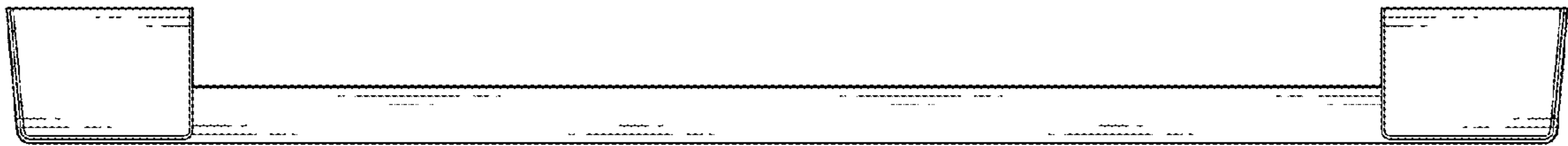

FIG. 7

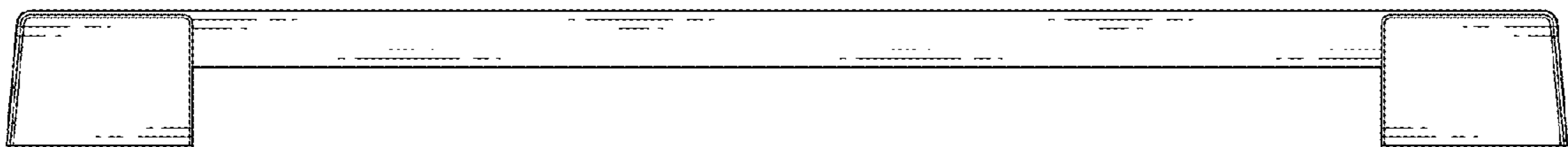

FIG. 8

