

US00D763638S

(12) **United States Design Patent**
Whitlock et al.

(10) **Patent No.:** **US D763,638 S**

(45) **Date of Patent:** **** Aug. 16, 2016**

(54) **COLLAPSIBLE CUTTING BOARD WITH DRAWER**

(71) Applicants: **Paul Whitlock**, Santa Monica, CA (US);
Valerie Whitlock, Santa Monica, CA (US)

(72) Inventors: **Paul Whitlock**, Santa Monica, CA (US);
Valerie Whitlock, Santa Monica, CA (US)

(**) Term: **14 Years**

(21) Appl. No.: **29/520,908**

(22) Filed: **Mar. 18, 2015**

(51) **LOC (10) Cl.** **07-04**

(52) **U.S. Cl.**
USPC **D7/698**; D7/699

(58) **Field of Classification Search**
USPC D7/354, 359, 408, 543, 549, 550.1, 586,
D7/673, 698-699; D32/55-57
CPC A47J 47/00; A47J 47/005; A47J 47/20;
B26D 7/0006; B26D 7/018; B26D 7/20;
B23D 21/00; B23K 37/04; B23K 37/053;
B23Q 16/001; F23H 17/08
See application file for complete search history.

(56) **References Cited**

U.S. PATENT DOCUMENTS

D212,494 S *	10/1968	Gruber	D7/698
D247,603 S *	3/1978	Grossman	D7/673
D304,277 S *	10/1989	Wolff	D10/46.2
D587,031 S *	2/2009	Pourounidis	D7/698
D588,879 S *	3/2009	Brett	D7/698
D598,252 S *	8/2009	West	D7/698
D608,165 S *	1/2010	Davies	D7/698
D620,312 S *	7/2010	Jendrass	D7/408
D628,848 S *	12/2010	Junkins	D7/354
D671,806 S *	12/2012	Kaufmann	D7/698

8,511,295 B2 *	8/2013	Buerkle	F23H 17/08 126/152 B
D738,160 S *	9/2015	Huang	D7/354
D739,690 S *	9/2015	Khuu	D7/698

* cited by examiner

Primary Examiner — Ricky Pham

(74) *Attorney, Agent, or Firm* — D. Whitlow Bivens

(57) **CLAIM**

The ornamental design for a collapsible cutting board with drawer, as shown and described.

DESCRIPTION

FIG. 1 is a perspective view of our new design in a collapsed configuration;
 FIG. 2 is a side view of the curved side thereof;
 FIG. 3 is a top view thereof;
 FIG. 4 is a side view of the pointed end thereof;
 FIG. 5 is a side view thereof;
 FIG. 6 is a bottom view thereof;
 FIG. 7 is an exploded perspective view thereof;
 FIG. 8 is a perspective view of our new design in an expanded configuration;
 FIG. 9 is a first side view thereof;
 FIG. 10 is a top view thereof;
 FIG. 11 is a second side view thereof;
 FIG. 12 is a third side view thereof;
 FIG. 13 is a fourth side view thereof;
 FIG. 14 is a bottom view thereof;
 FIG. 15 is an interior cross-sectional view of a portion of our new design in the collapsed configuration; and,
 FIG. 16 is a cut-away, partially-exploded perspective view of a portion of our new design in the collapsed configuration.
 The broken lines shown in the drawings are for illustrative purposes only and form no part of the claimed design.

1 Claim, 8 Drawing Sheets

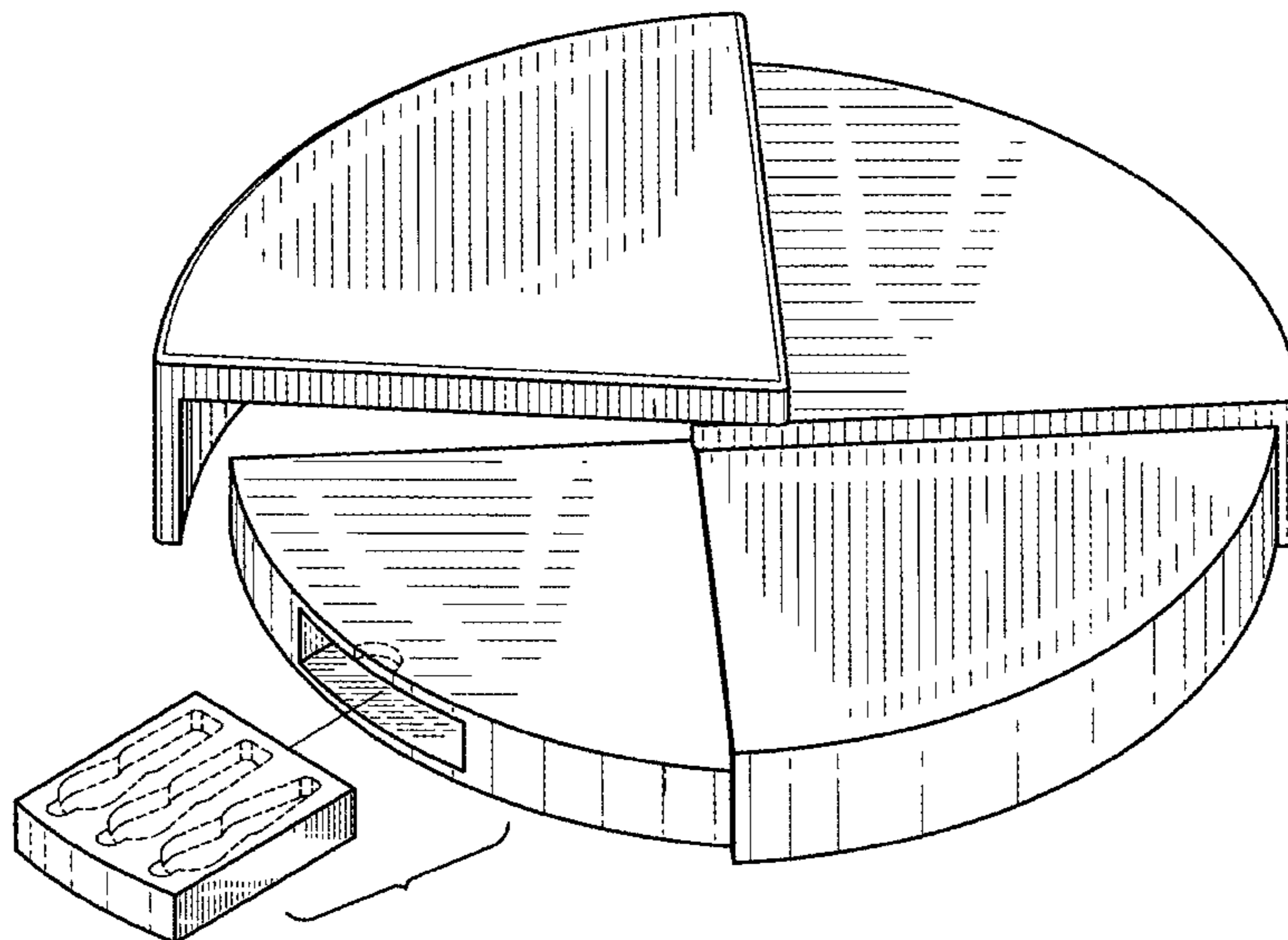

FIG. 1

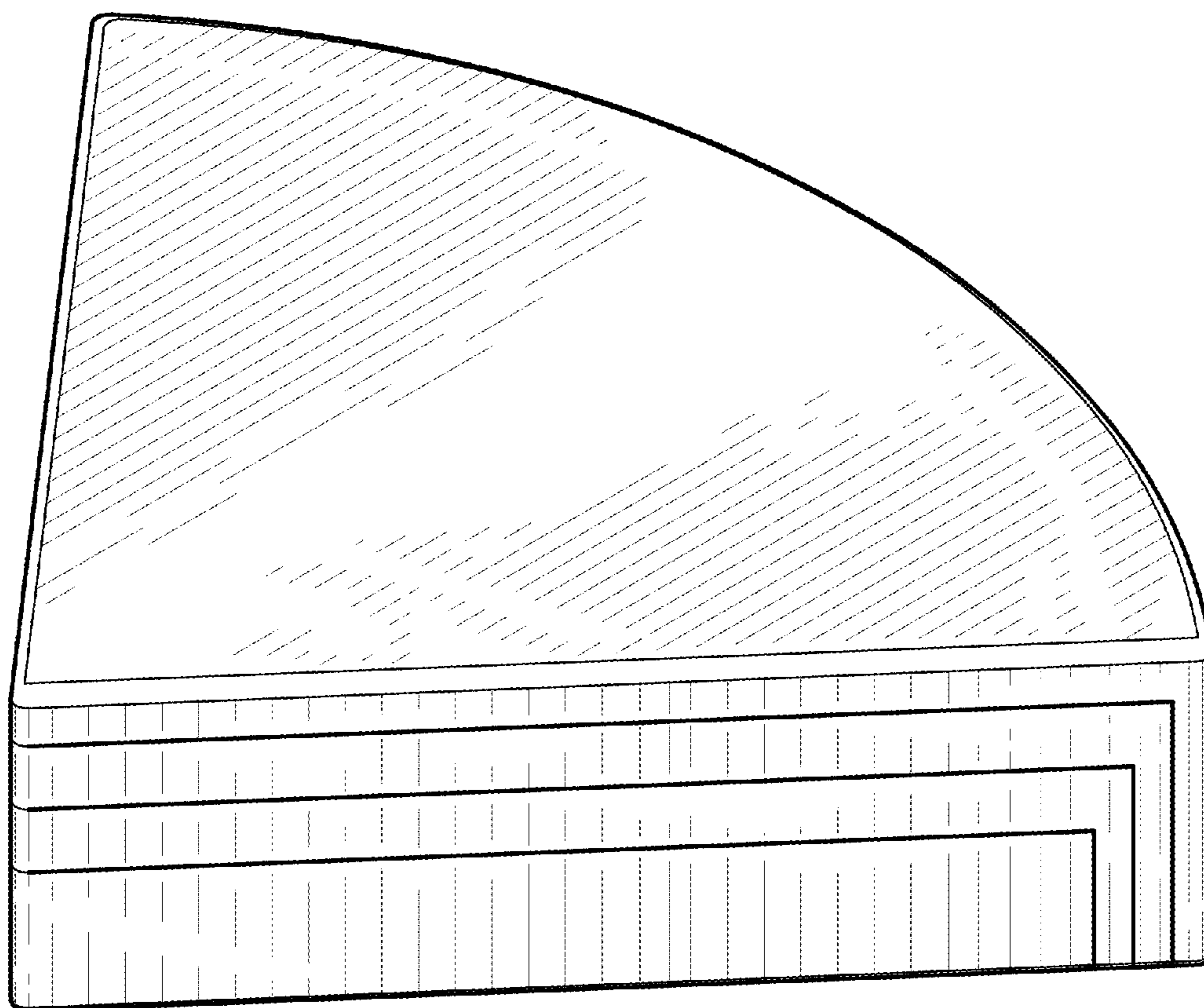

FIG. 2

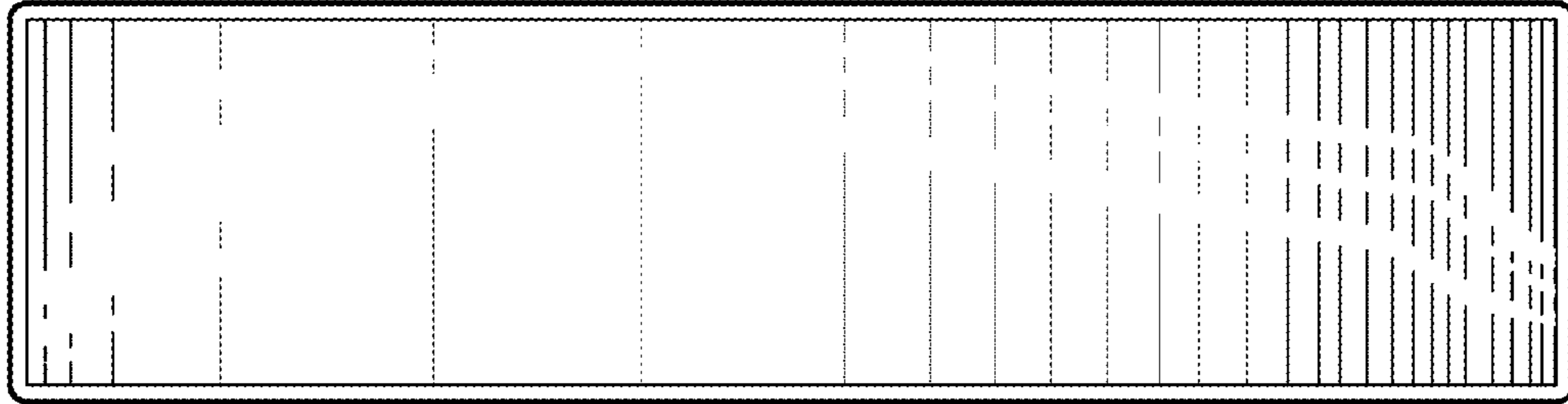

FIG. 3

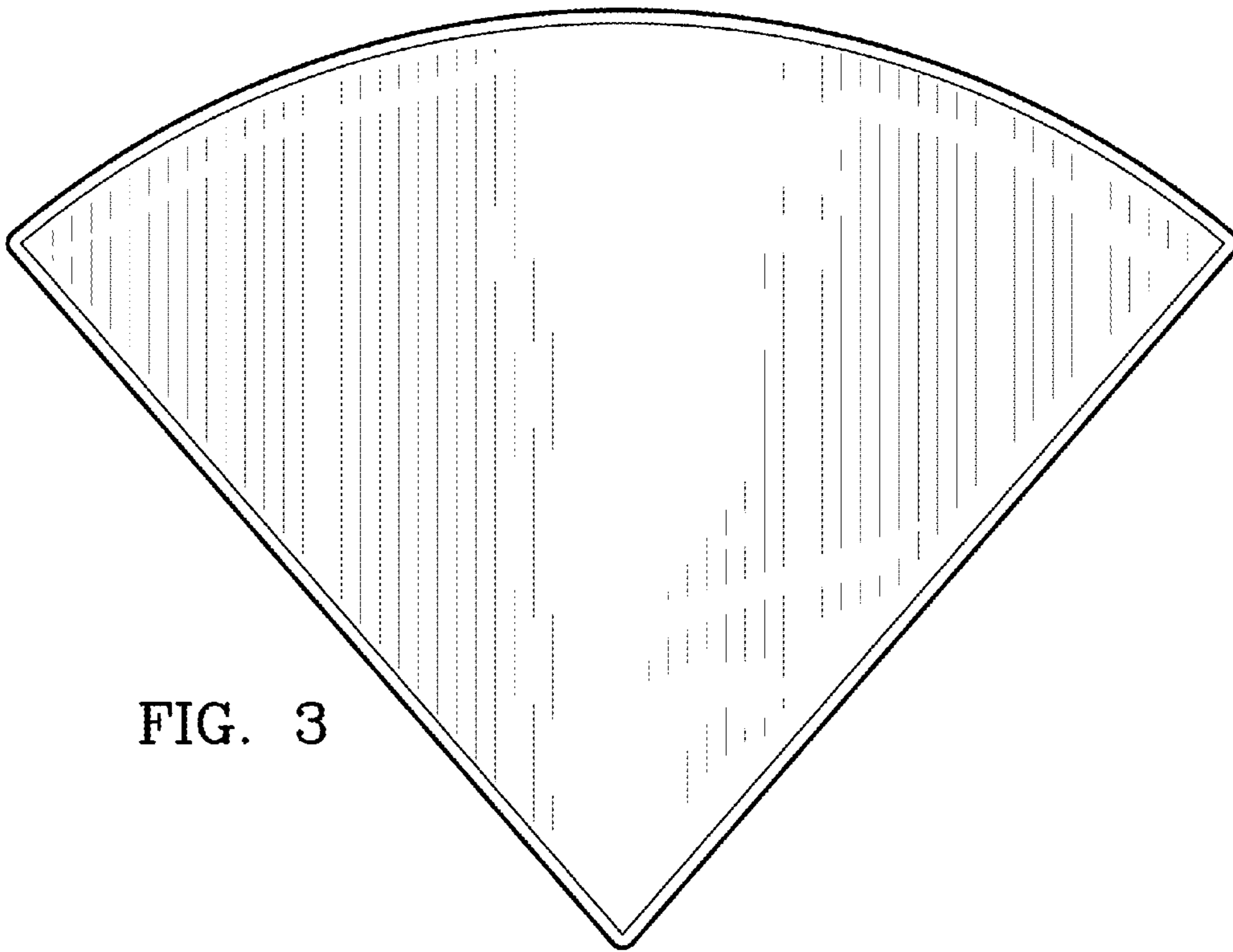

FIG. 4

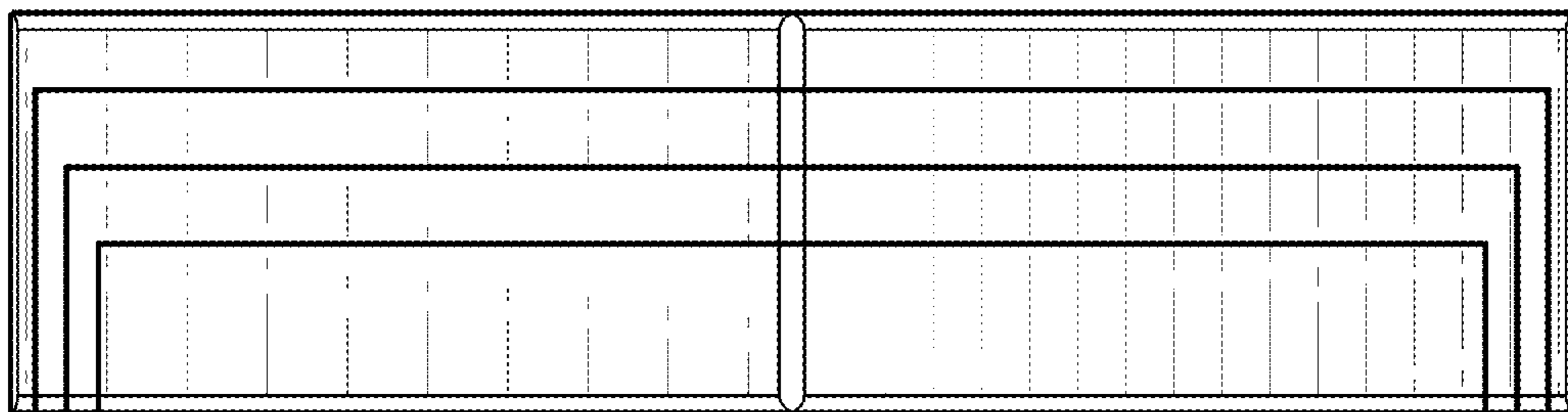

FIG. 5

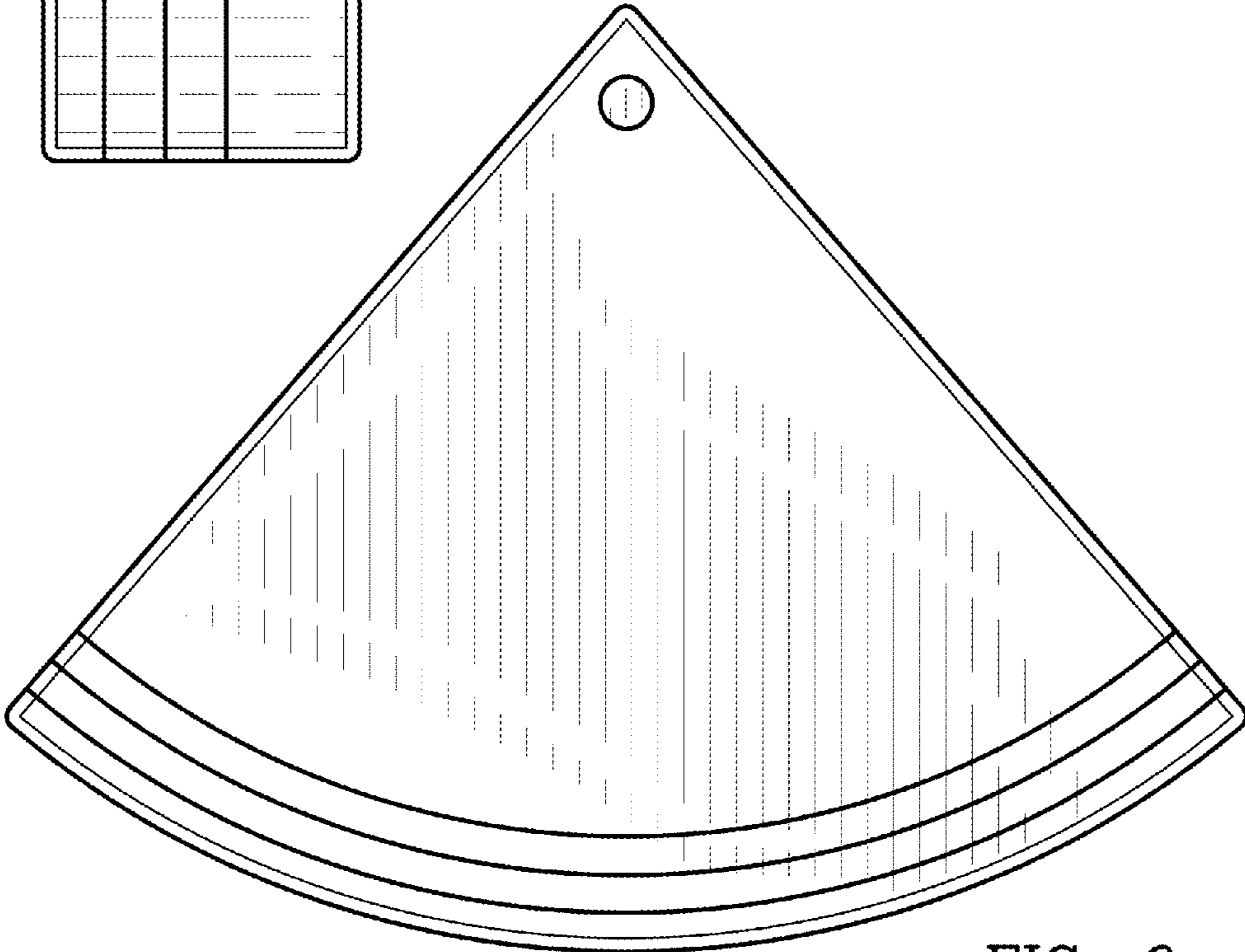
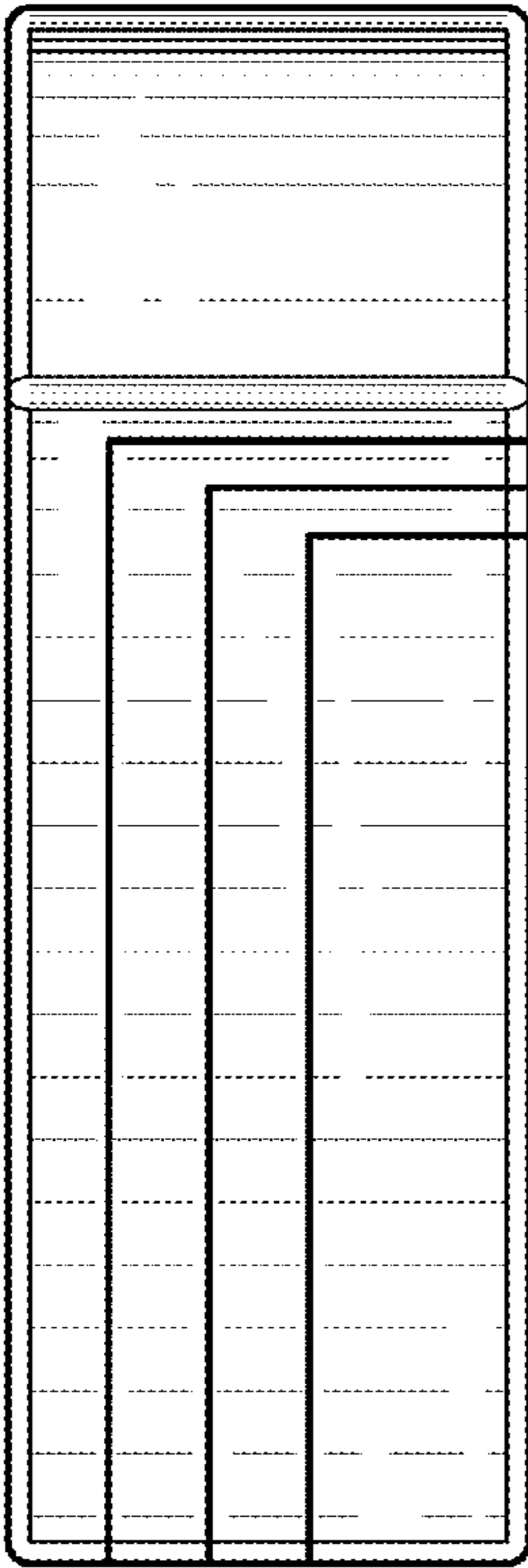
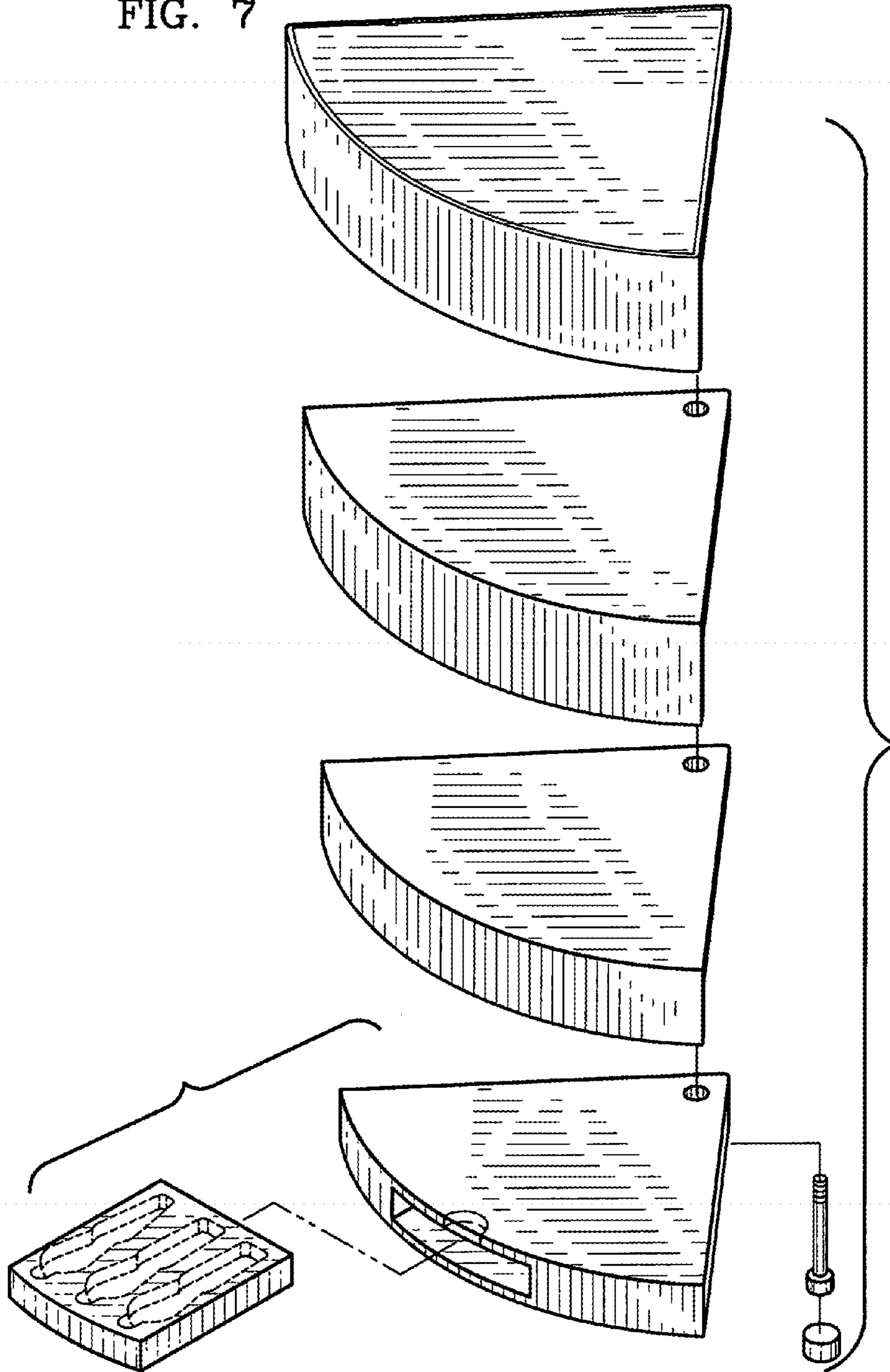

FIG. 6

FIG. 7



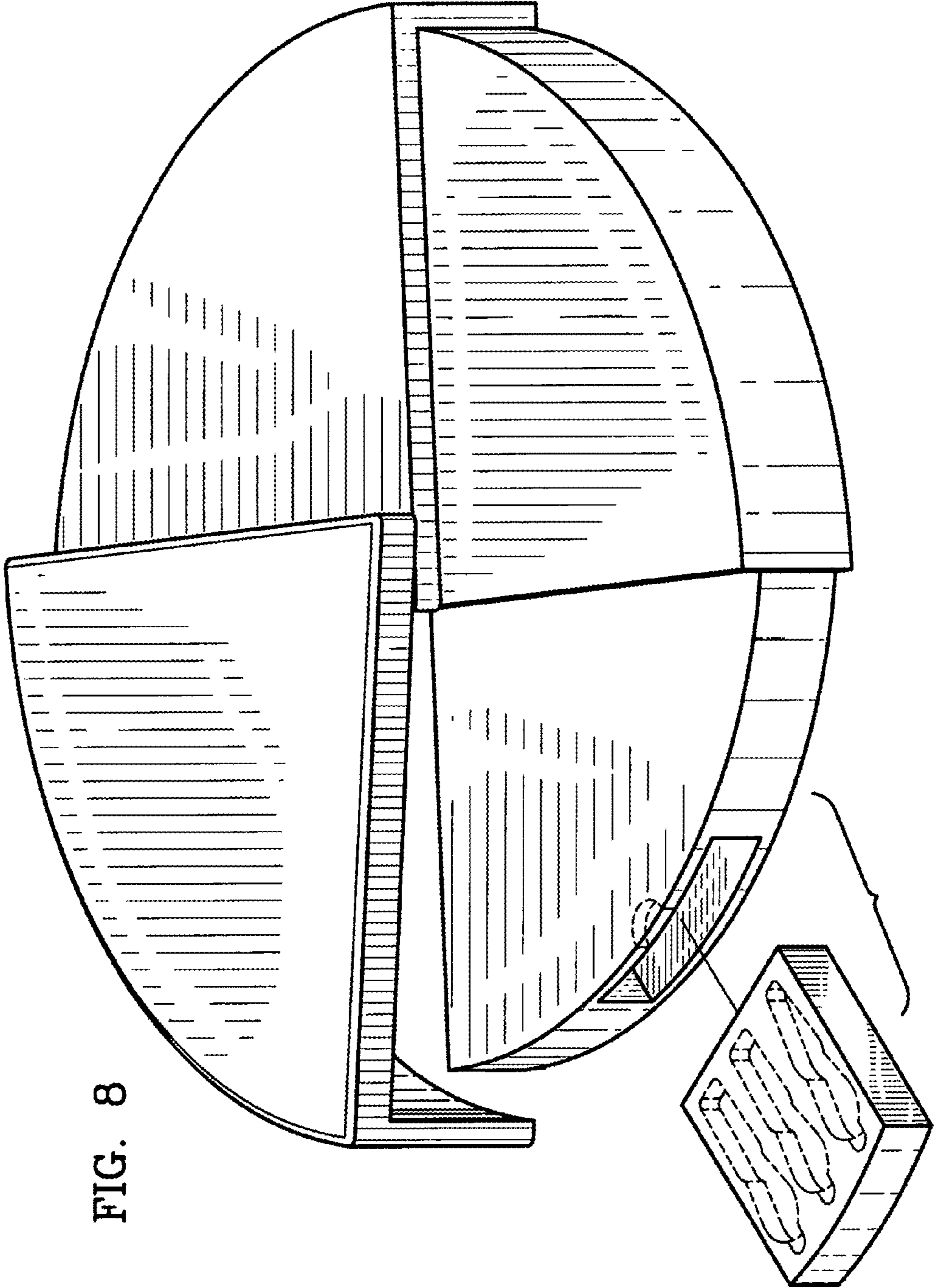

FIG. 8

FIG. 9

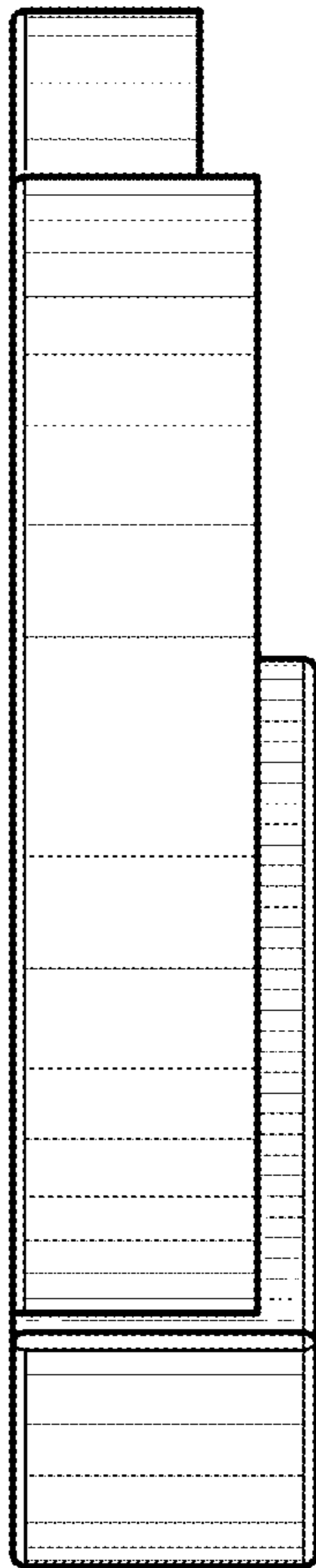

FIG. 10

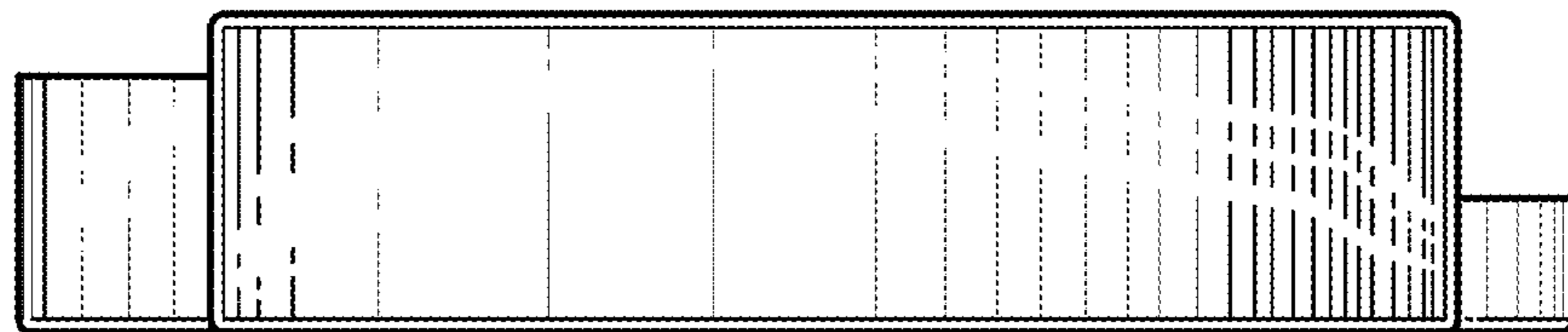
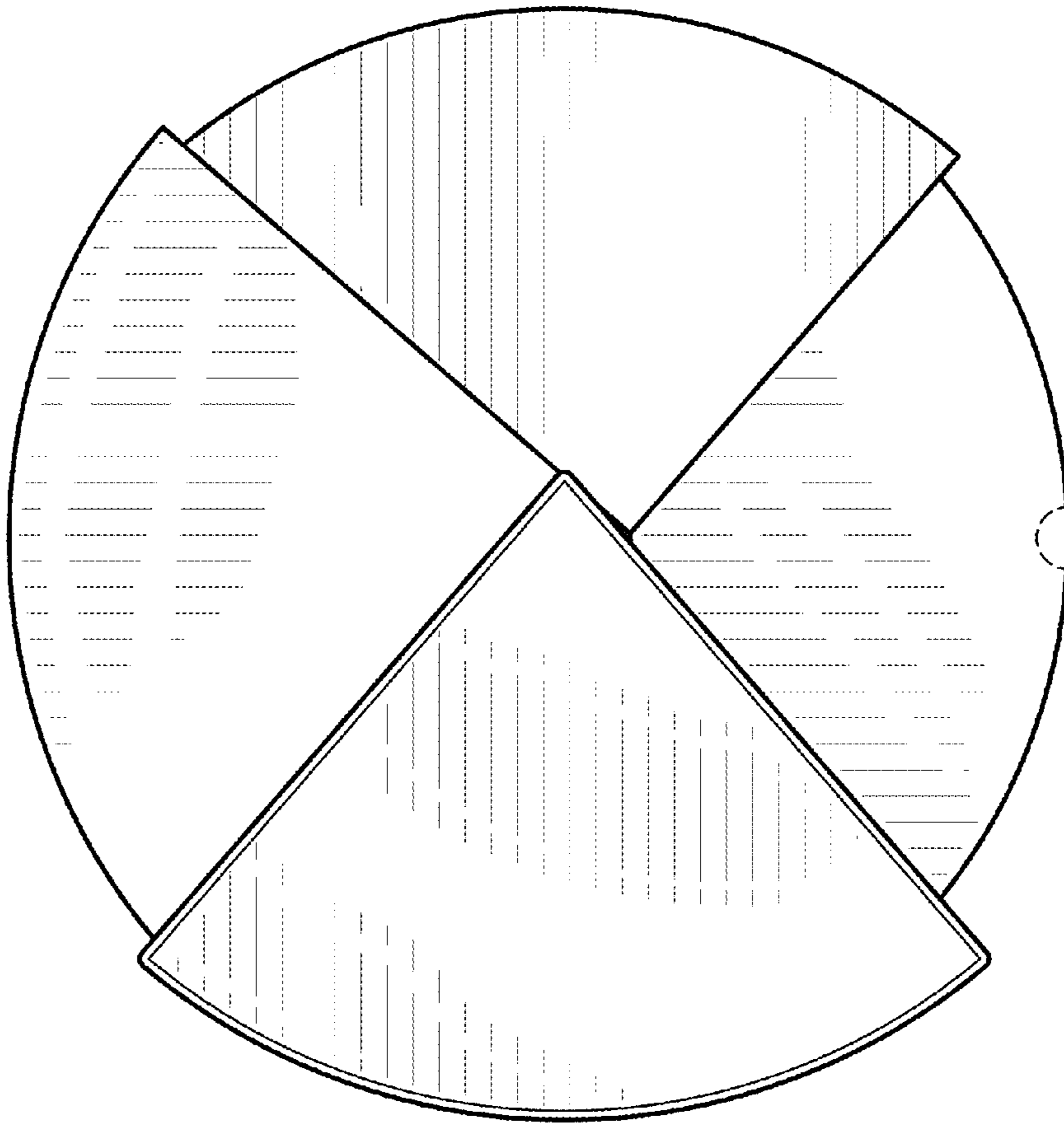

FIG. 11

FIG. 12

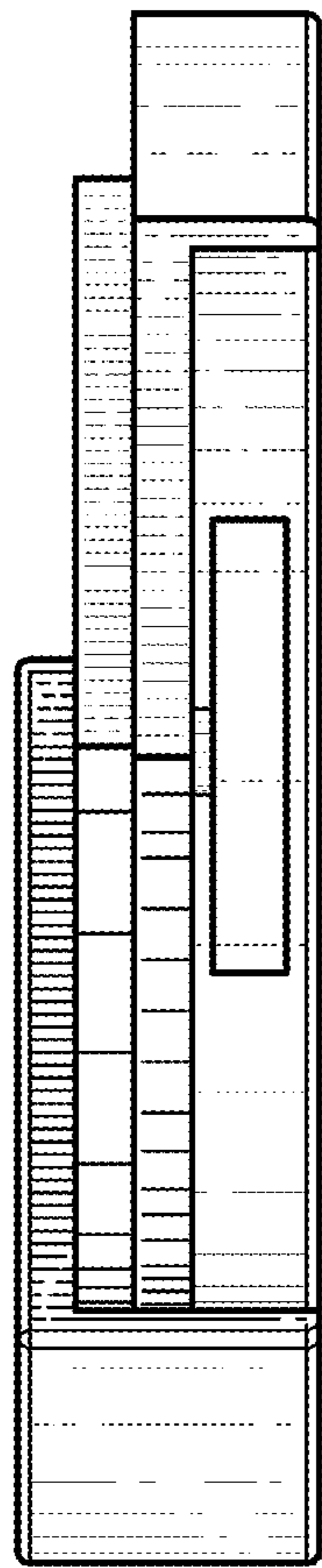

FIG. 13

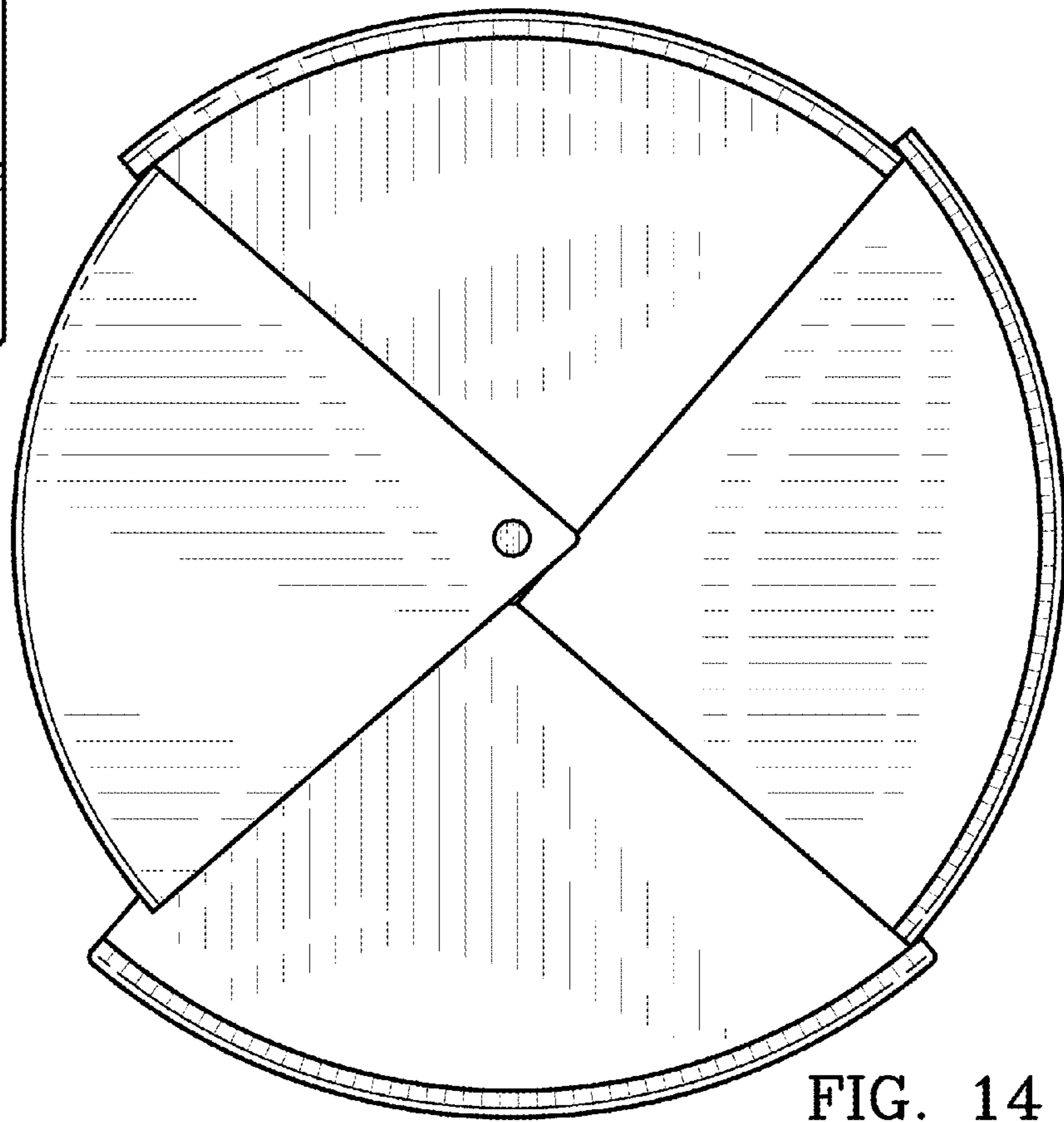
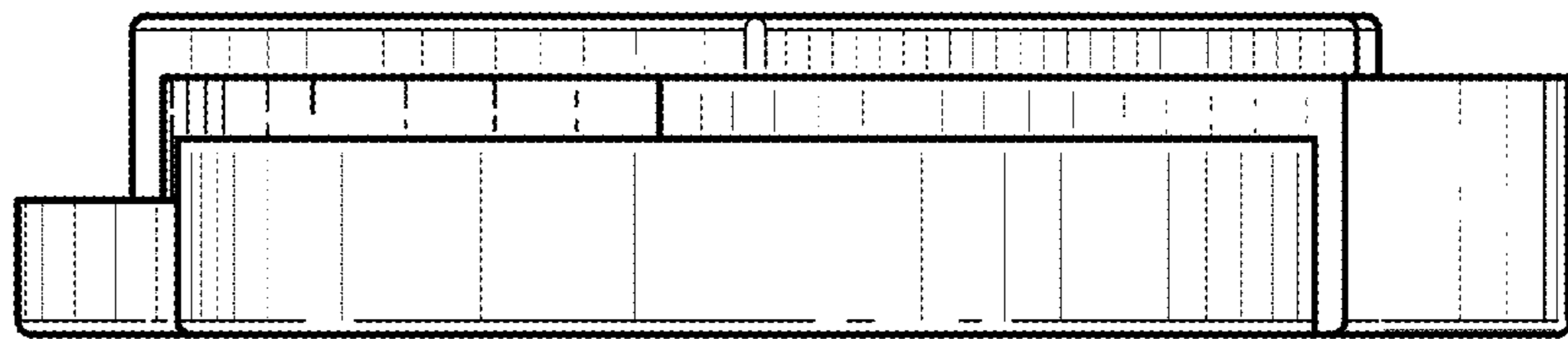

FIG. 14

FIG. 15

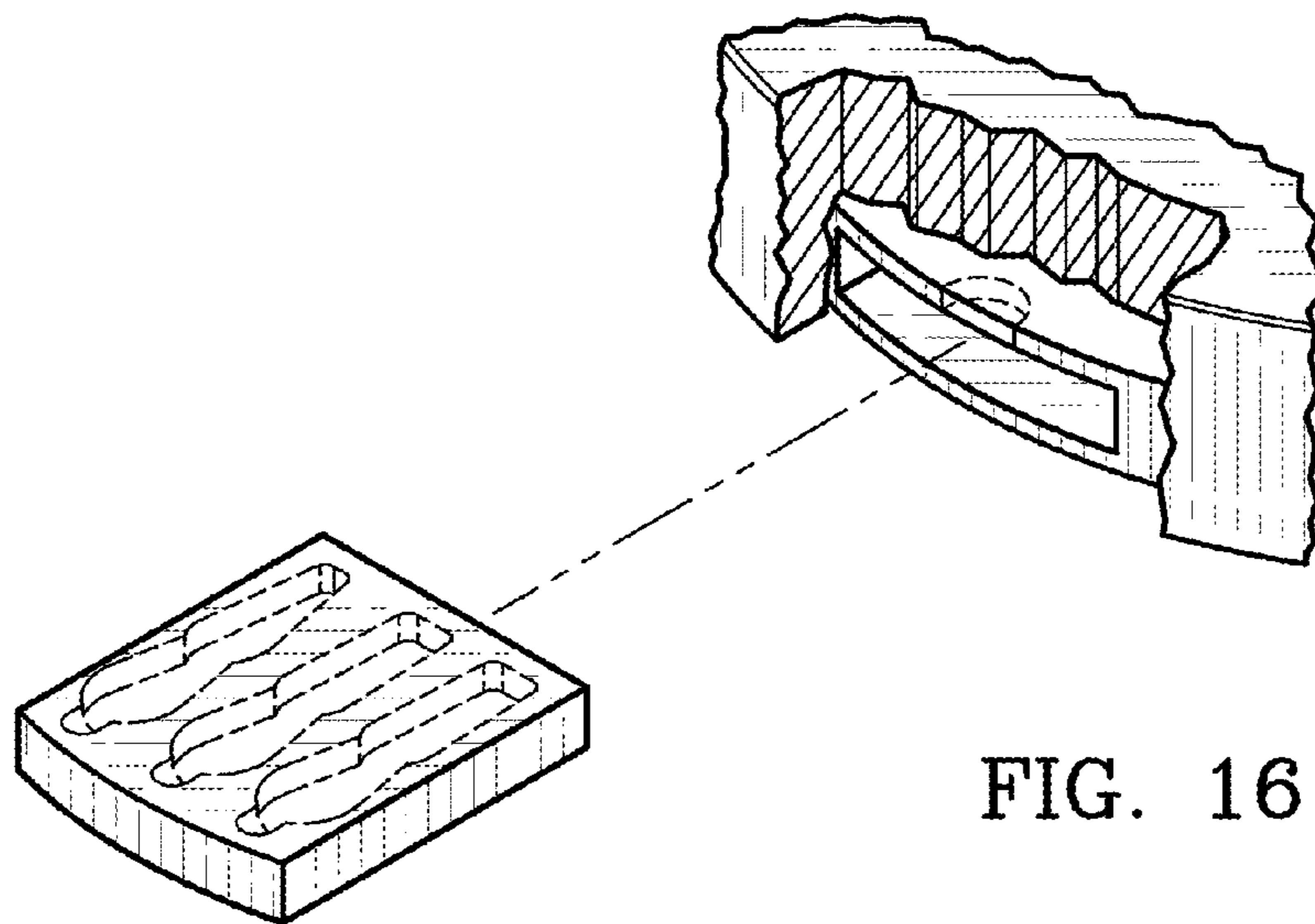
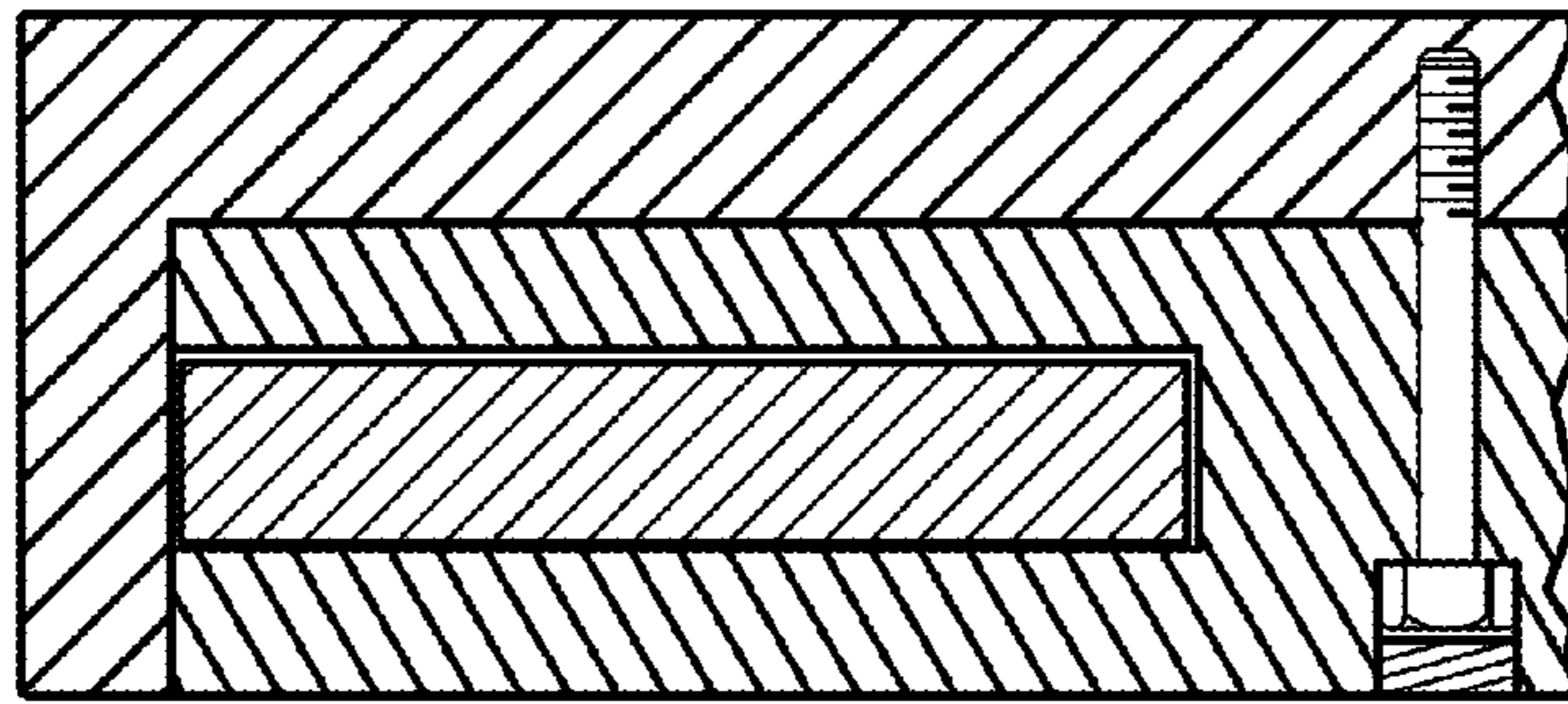

FIG. 16