

US00D763637S

(12) **United States Design Patent**
Arseneault

(10) **Patent No.:** **US D763,637 S**

(45) **Date of Patent:** **** Aug. 16, 2016**

(54) **CORE REMOVER FOR SMALL FRUIT AND VEGETABLES**

5,056,223 A * 10/1991 Buck A47J 25/00
30/113.1

5,092,043 A * 3/1992 Shirkey A47J 25/00
30/113.1

6,032,368 A * 3/2000 Huang A47J 25/00
30/113.1

(71) Applicant: **René Arseneault**, Quebec (CA)

(72) Inventor: **René Arseneault**, Quebec (CA)

(**) Term: **14 Years**

* cited by examiner

Primary Examiner — Terry Wallace

(21) Appl. No.: **29/505,047**

(22) Filed: **May 8, 2015**

(51) **LOC (10) Cl.** **07-04**

(52) **U.S. Cl.**
USPC **D7/693**

(58) **Field of Classification Search**

USPC D7/680–696, 393, 395; D8/14, 47, 82,
D8/88, 107

CPC A47J 25/20; A47J 17/02; A47J 17/04;
A47J 23/00; B36D 3/16; B26D 3/169

See application file for complete search history.

(57) **CLAIM**

The ornamental design for a “core remover for small fruit and vegetables,” as shown and described.

DESCRIPTION

FIG. 1 is a front perspective view of the core remover for small fruit and vegetables in accordance with the design; FIG. 2 is a rear perspective view thereof; FIG. 3 is a front elevational view thereof; FIG. 4 is a side elevational view thereof; FIG. 5 is a rear elevational view thereof; FIG. 6 is a top end view thereof; and, FIG. 7 is a bottom end view thereof.

(56) **References Cited**

U.S. PATENT DOCUMENTS

2,032,562 A * 3/1936 Burns A47J 17/04
30/113.3

2,188,362 A * 1/1940 Krilow A47J 25/00
30/113.3

1 Claim, 2 Drawing Sheets

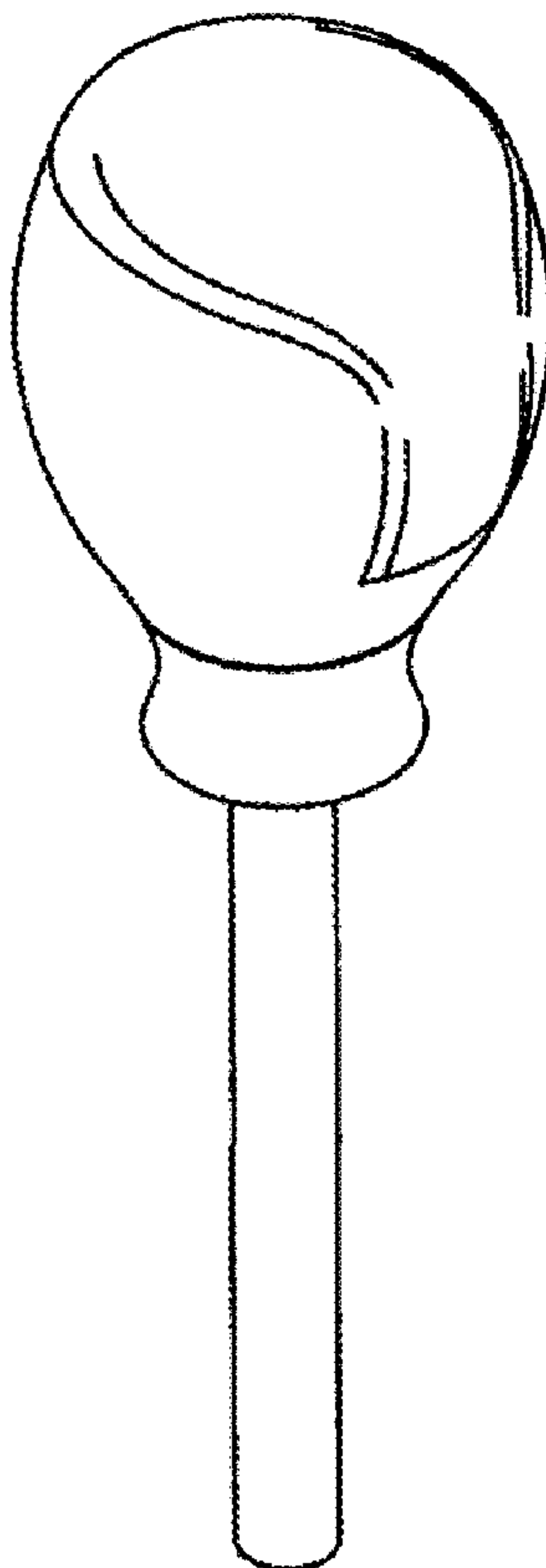

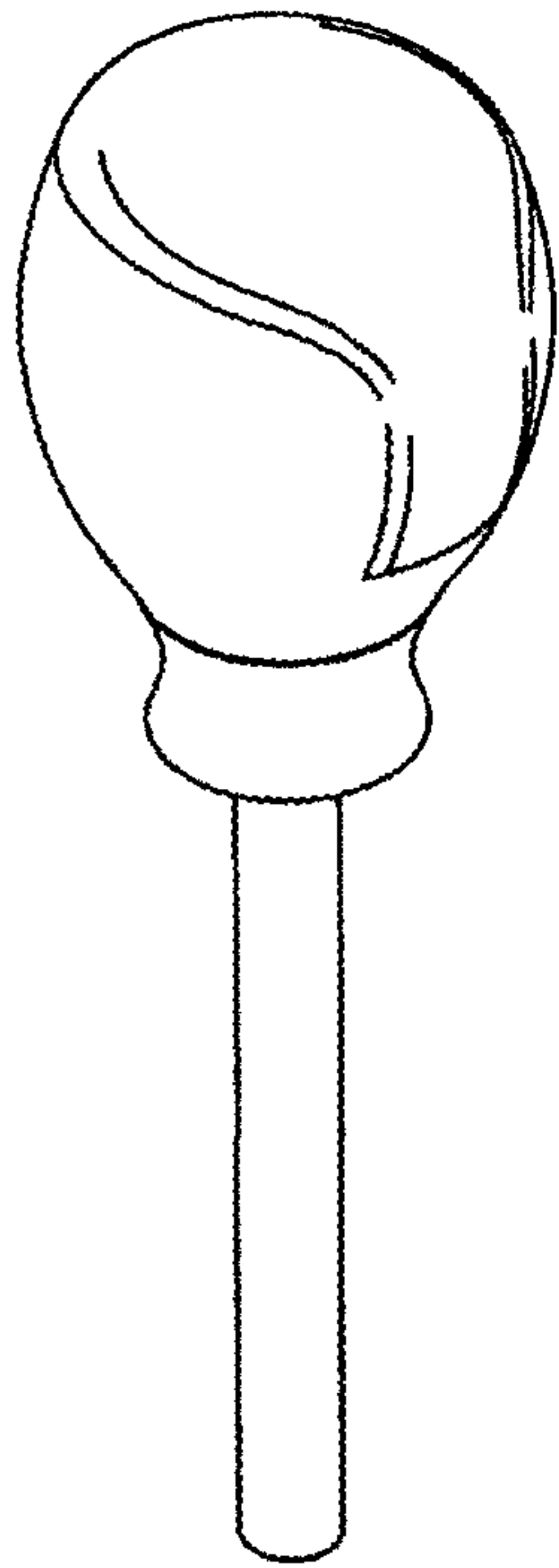

FIG. 1

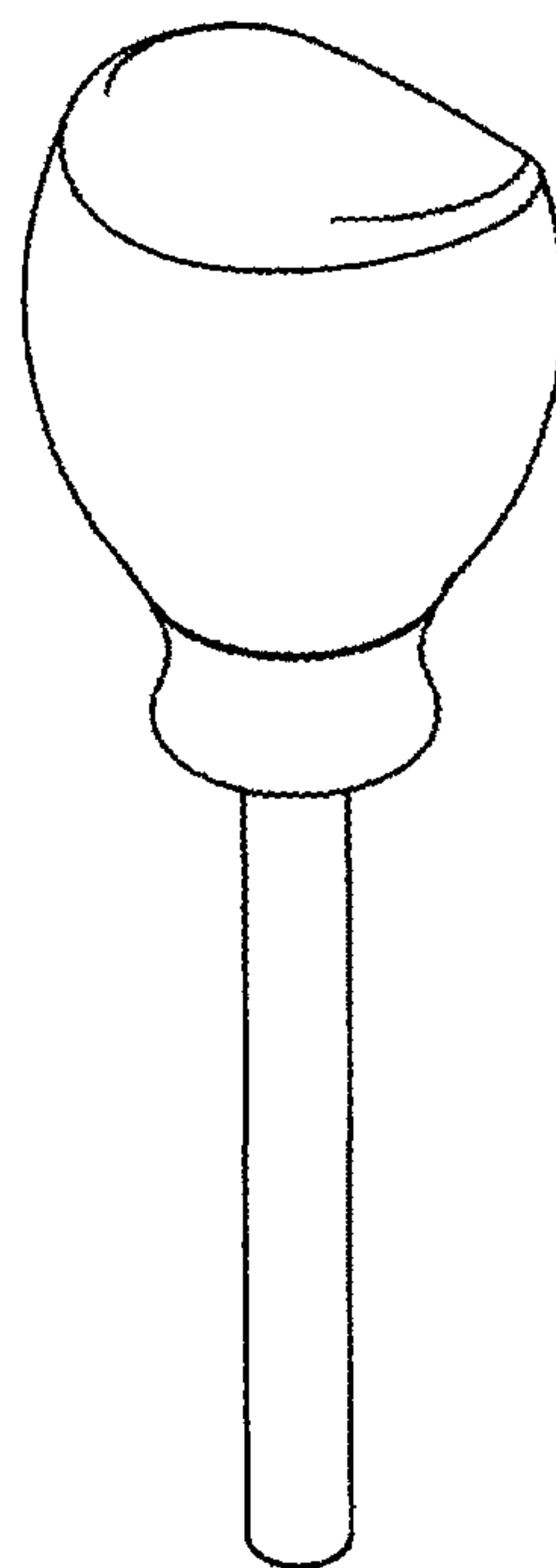

FIG. 2

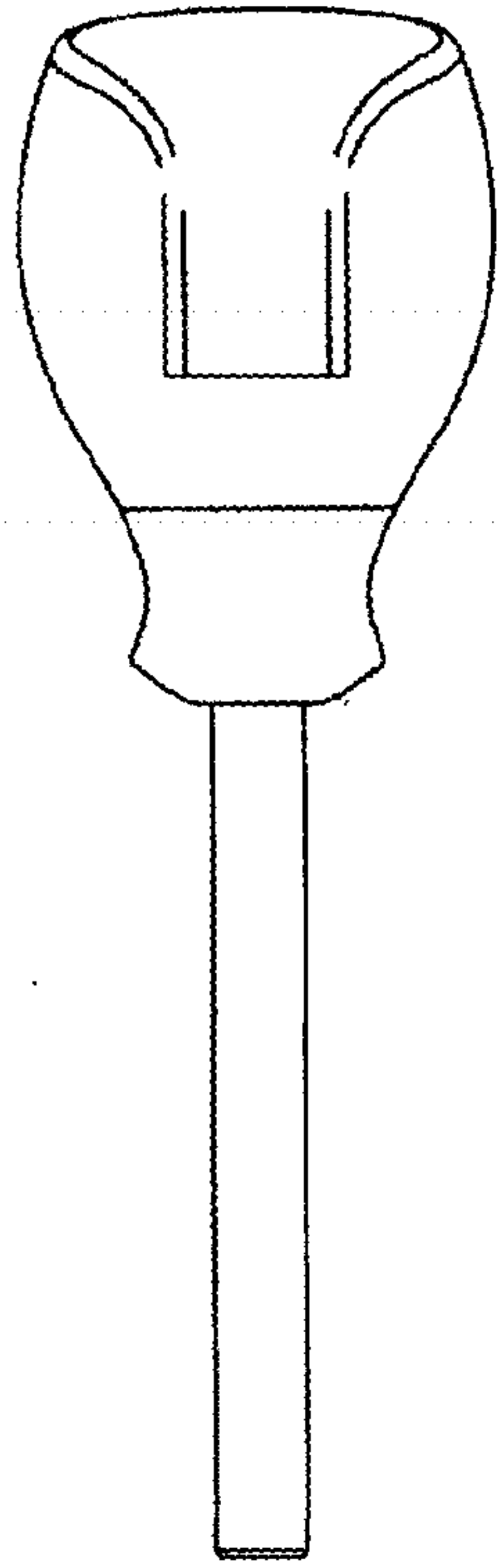

FIG. 3

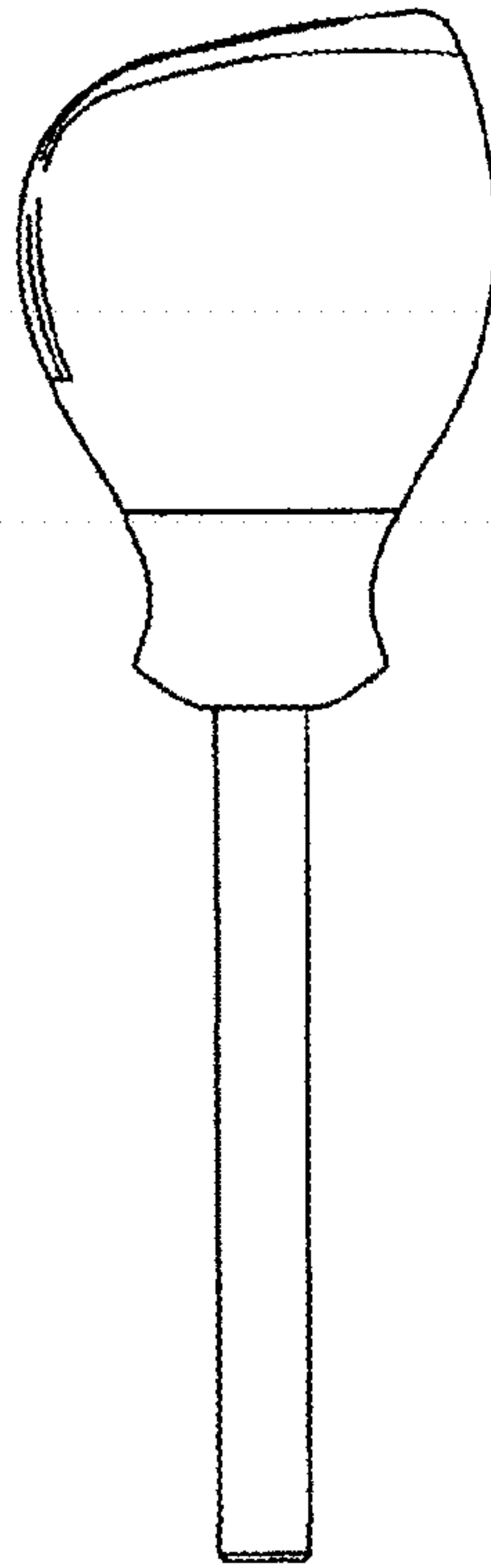

FIG. 4

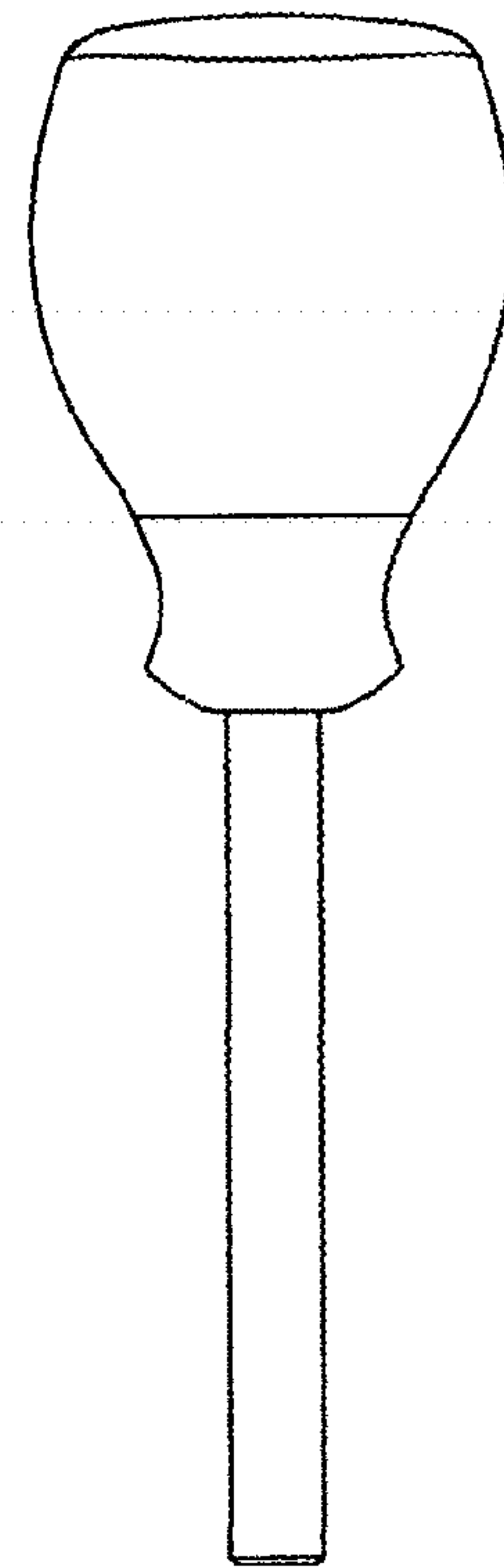

FIG. 5

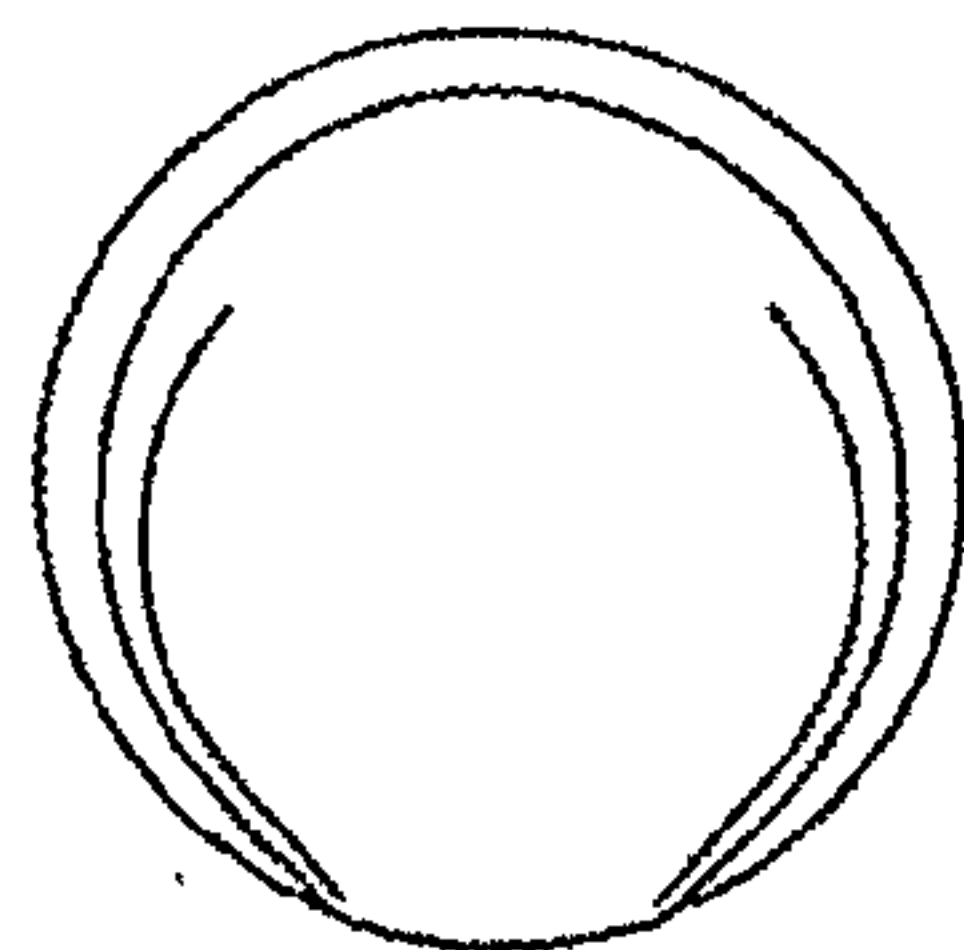

FIG. 6

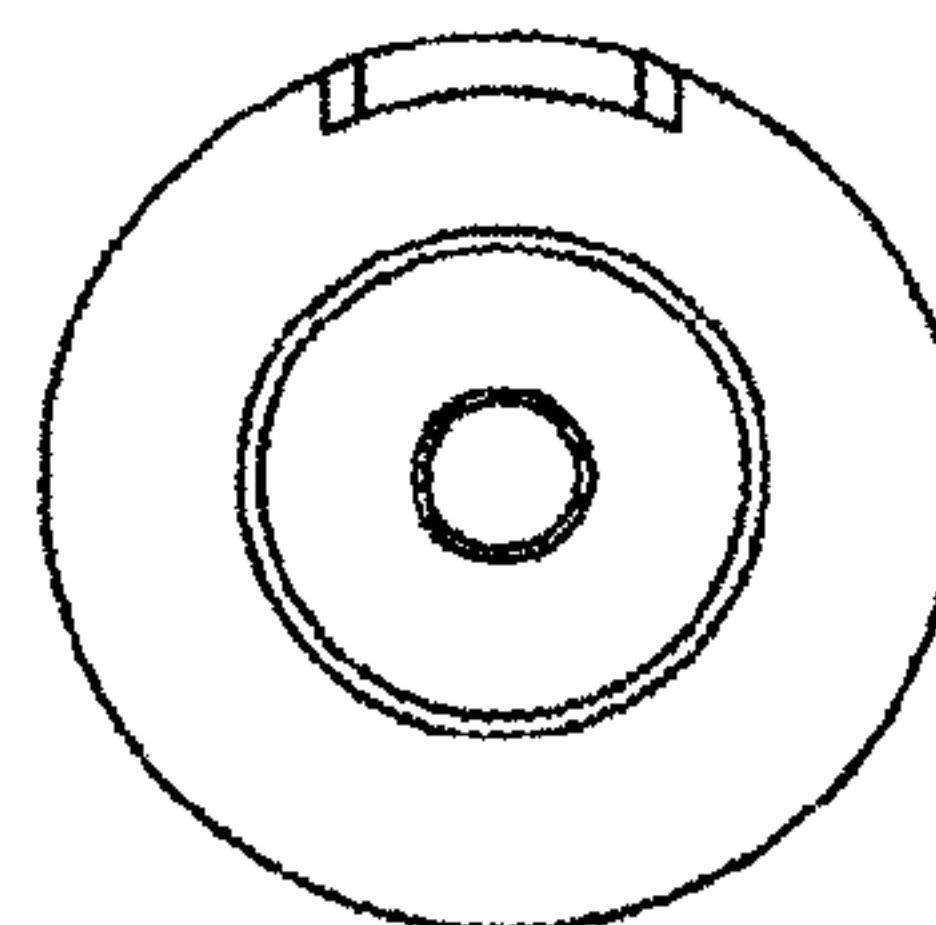

FIG. 7