



US00D763609S

(12) **United States Design Patent**
Copier et al.

(10) **Patent No.:** **US D763,609 S**

(45) **Date of Patent:** **** Aug. 16, 2016**

(54) **SUPPORT LEG**

(71) Applicant: **DSA International, LLC**, Zeeland, MI (US)

(72) Inventors: **Elliott Guy Copier**, Grand Rapids, MI (US); **Paul Julius Martus**, Grand Rapids, MI (US); **Douglas Gary Oswald**, Grand Rapids, MI (US)

(73) Assignee: **DSA International, Inc.**, Zeeland, MI (US)

(**) Term: **14 Years**

(21) Appl. No.: **29/493,191**

(22) Filed: **Jun. 6, 2014**

(51) **LOC (10) Cl.** **06-06**

(52) **U.S. Cl.**
USPC **D6/709**

(58) **Field of Classification Search**
USPC D6/709, 709.21, 710, 708.23, 718, D6/648.1, 656, 656.12, 656.17
CPC A47C 19/024; A47C 19/025; A47C 19/02; A47B 91/00; A47B 13/00; A47B 2013/2013; A47B 2013/025; A47B 91/02; A47B 91/022; A47B 2200/0032; A47B 2200/0052; A47B 2200/005

See application file for complete search history.

(56) **References Cited**

U.S. PATENT DOCUMENTS

D182,642 S *	4/1958	Curger	D6/708.23
D193,094 S	6/1962	Sullivan		
D204,189 S *	3/1966	Dillon	D6/708.23
D260,216 S	8/1981	Buhk		
D276,396 S	11/1984	Locher		
D278,012 S	3/1985	Doerner		
D336,395 S *	6/1993	Sulzer	D6/708.23
D458,060 S	6/2002	Vo		
D471,039 S	3/2003	Chen		
D555,945 S *	11/2007	Pearsons	D6/709
D560,406 S *	1/2008	Privatt	D6/708.23
D569,136 S	5/2008	Pearsons		

D569,663 S	5/2008	Pearsons
D622,984 S	9/2010	Babick
D634,949 S	3/2011	Babick
D644,458 S	9/2011	Babick
D644,459 S	9/2011	Babick
D653,479 S	2/2012	Babick

* cited by examiner

Primary Examiner — Janice Seeger

(74) *Attorney, Agent, or Firm* — Niro McAndrews, LLC

(57) **CLAIM**

The ornamental design for a support leg, as shown and described.

DESCRIPTION

FIG. 1 is a front perspective view of a support leg, showing my new design;
 FIG. 2 is a upper rear perspective view thereof;
 FIG. 3 is a lower rear perspective view thereof;
 FIG. 4 is a side elevational view thereof;
 FIG. 5 is a front elevational view thereof;
 FIG. 6 is a rear elevational view thereof;
 FIG. 7 is a top plan view thereof;
 FIG. 8 is a bottom plan view thereof;
 FIG. 9 is a front perspective view of a support leg, showing a second embodiment of my new design;
 FIG. 10 is a upper rear perspective view thereof;
 FIG. 11 is a lower rear perspective view thereof;
 FIG. 12 is a side elevational view thereof;
 FIG. 13 is a front elevational view thereof;
 FIG. 14 is a rear elevational view thereof;
 FIG. 15 is a top plan view thereof;
 FIG. 16 is a bottom plan view thereof;
 FIG. 17 is a front perspective view of a support leg, showing a third embodiment of my new design;
 FIG. 18 is a upper rear perspective view thereof;
 FIG. 19 is a lower rear perspective view thereof;
 FIG. 20 is a side elevational view thereof;
 FIG. 21 is a front elevational view thereof;
 FIG. 22 is a rear elevational view thereof;
 FIG. 23 is a top plan view thereof;
 FIG. 24 is a bottom plan view thereof;

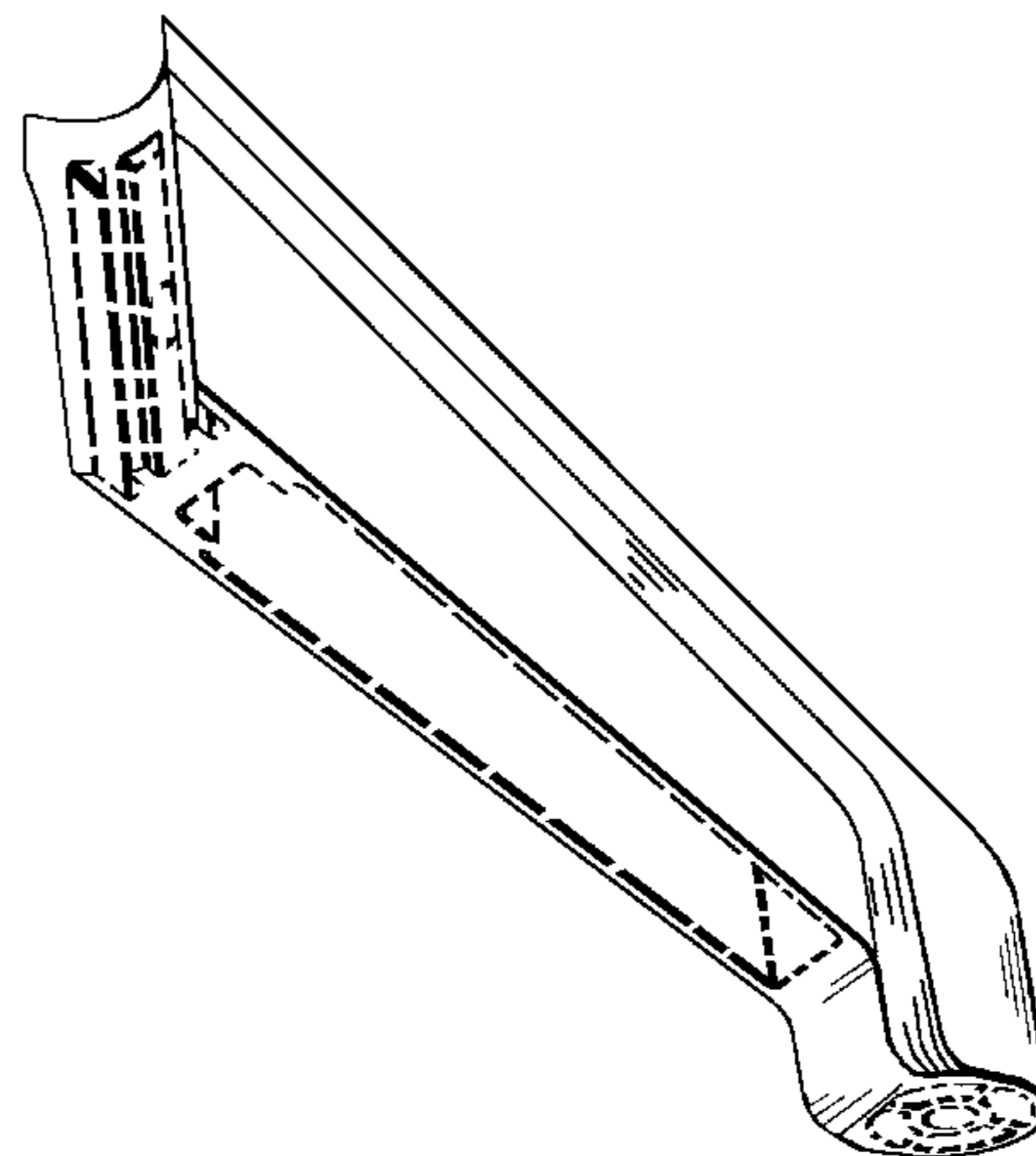
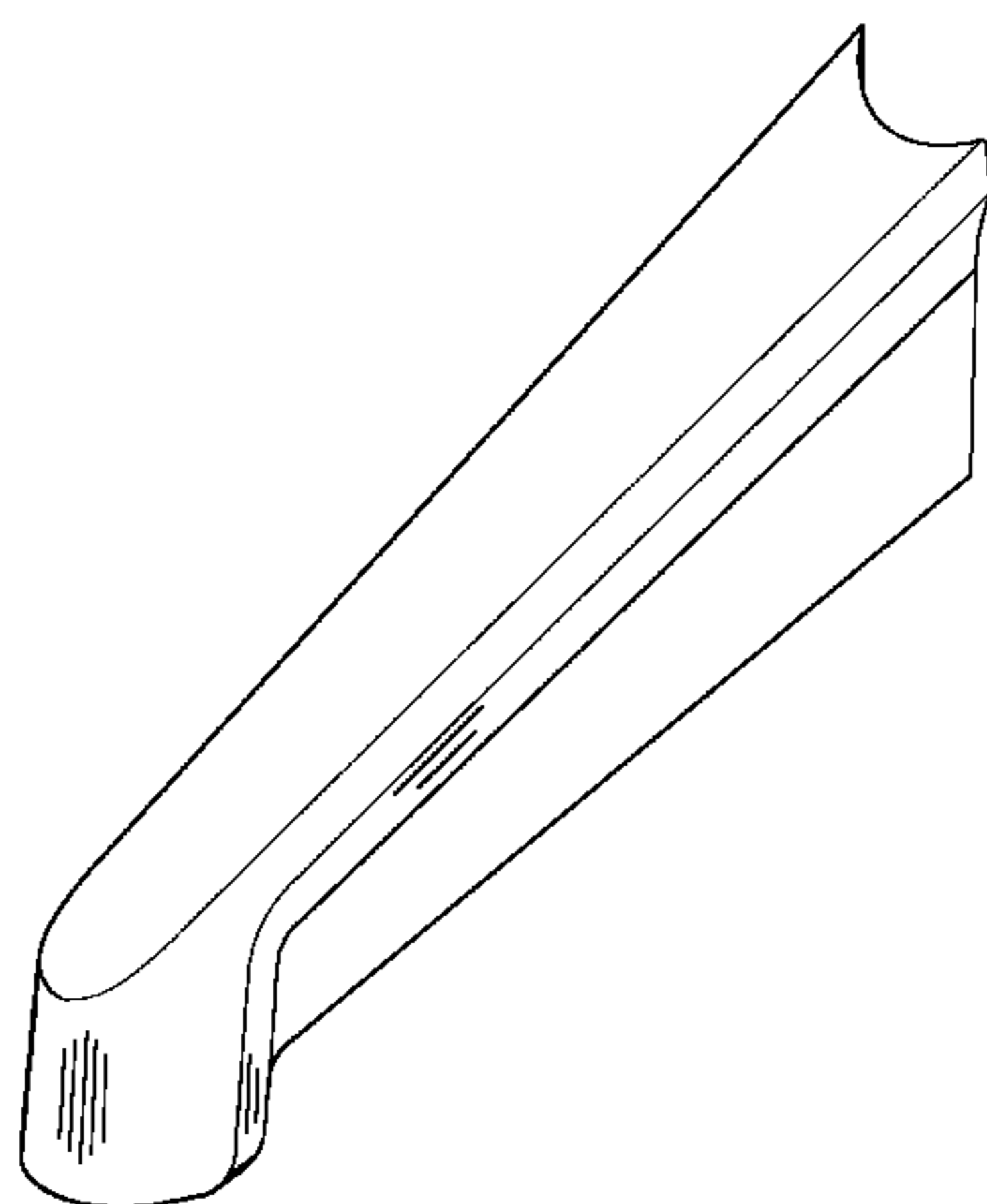

FIG. 25 is a front perspective view of a support leg, showing a fourth embodiment of my new design;
FIG. 26 is a upper rear perspective view thereof;
FIG. 27 is a lower rear perspective view thereof;
FIG. 28 is a side elevational view thereof;
FIG. 29 is a front elevational view thereof;
FIG. 30 is a rear elevational view thereof;
FIG. 31 is a top plan view thereof;
FIG. 32 is a bottom plan view thereof;
FIG. 33 is a front perspective view of a support leg, showing a fifth embodiment of my new design;
FIG. 34 is a upper rear perspective view thereof;

FIG. 35 is a lower rear perspective view thereof;
FIG. 36 is a side elevational view thereof;
FIG. 37 is a front elevational view thereof;
FIG. 38 is a rear elevational view thereof;
FIG. 39 is a top plan view thereof;
FIG. 40 is a bottom plan view thereof; and,
FIG. 41 is partial lower perspective view thereof.
The first through fourth embodiments are also represented by FIG. 41.
The broken lines shown in the figures are for illustrative purposes only and form no part of the claimed design.

1 Claim, 31 Drawing Sheets

FIG. 1

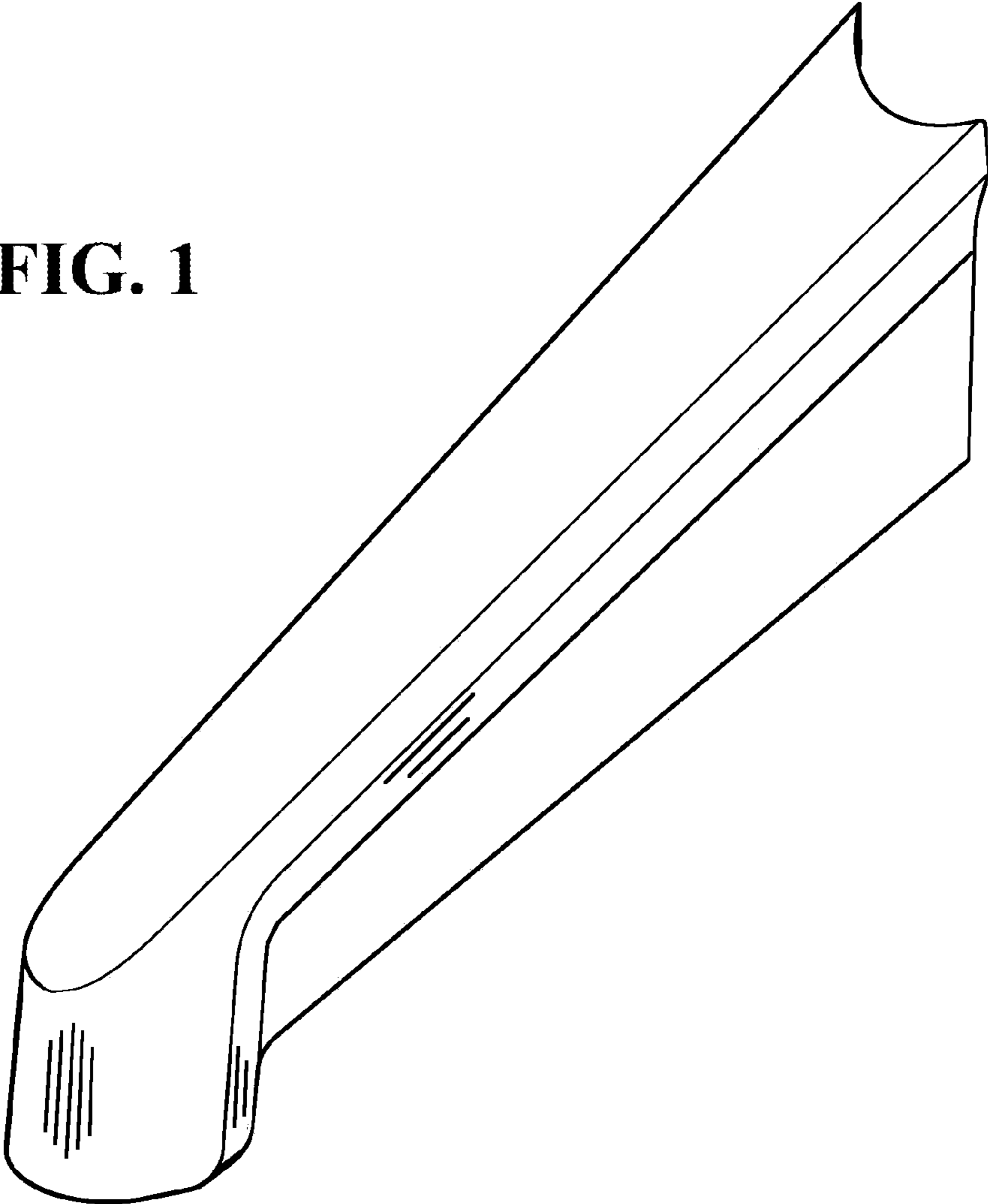
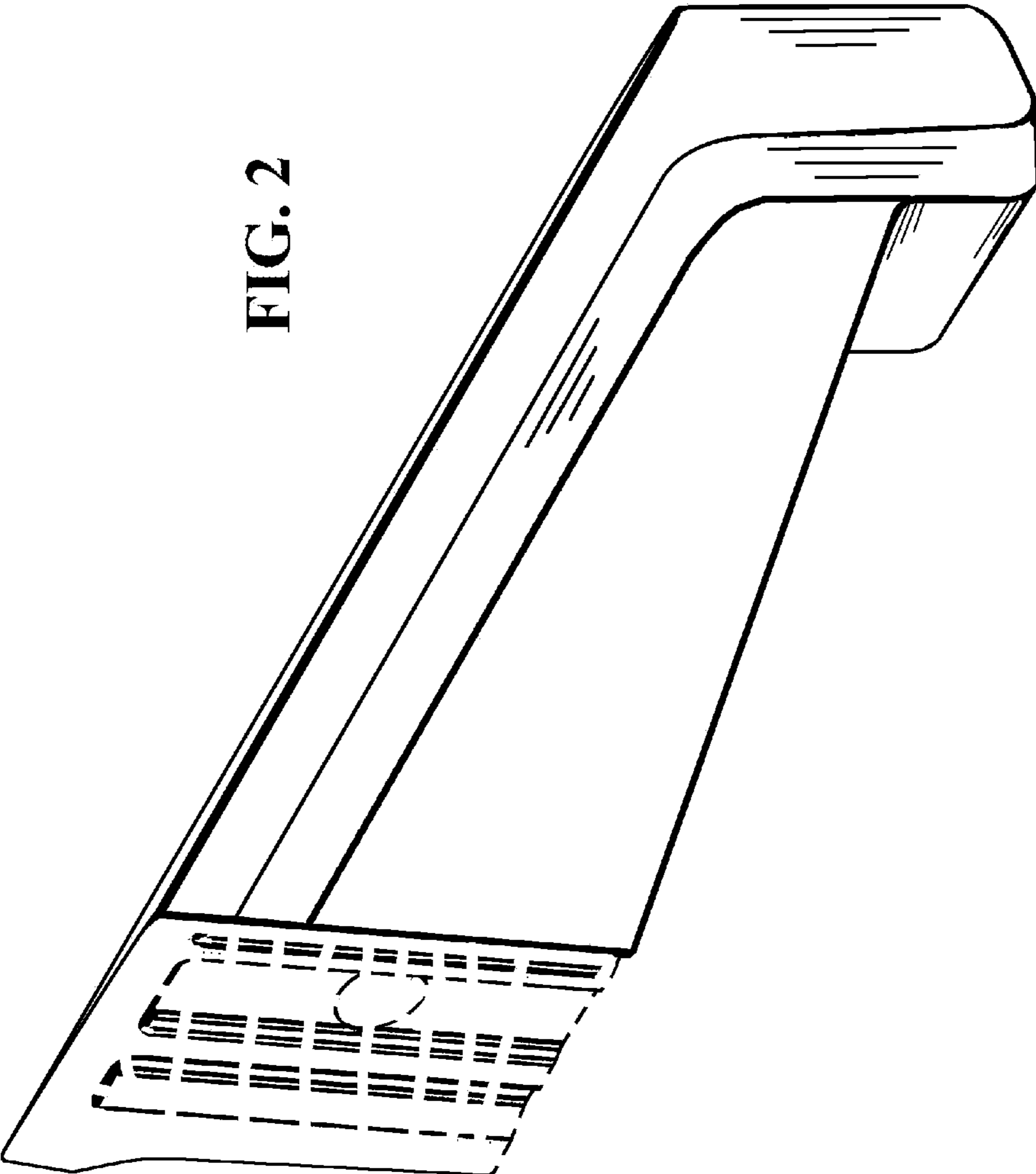

FIG. 2



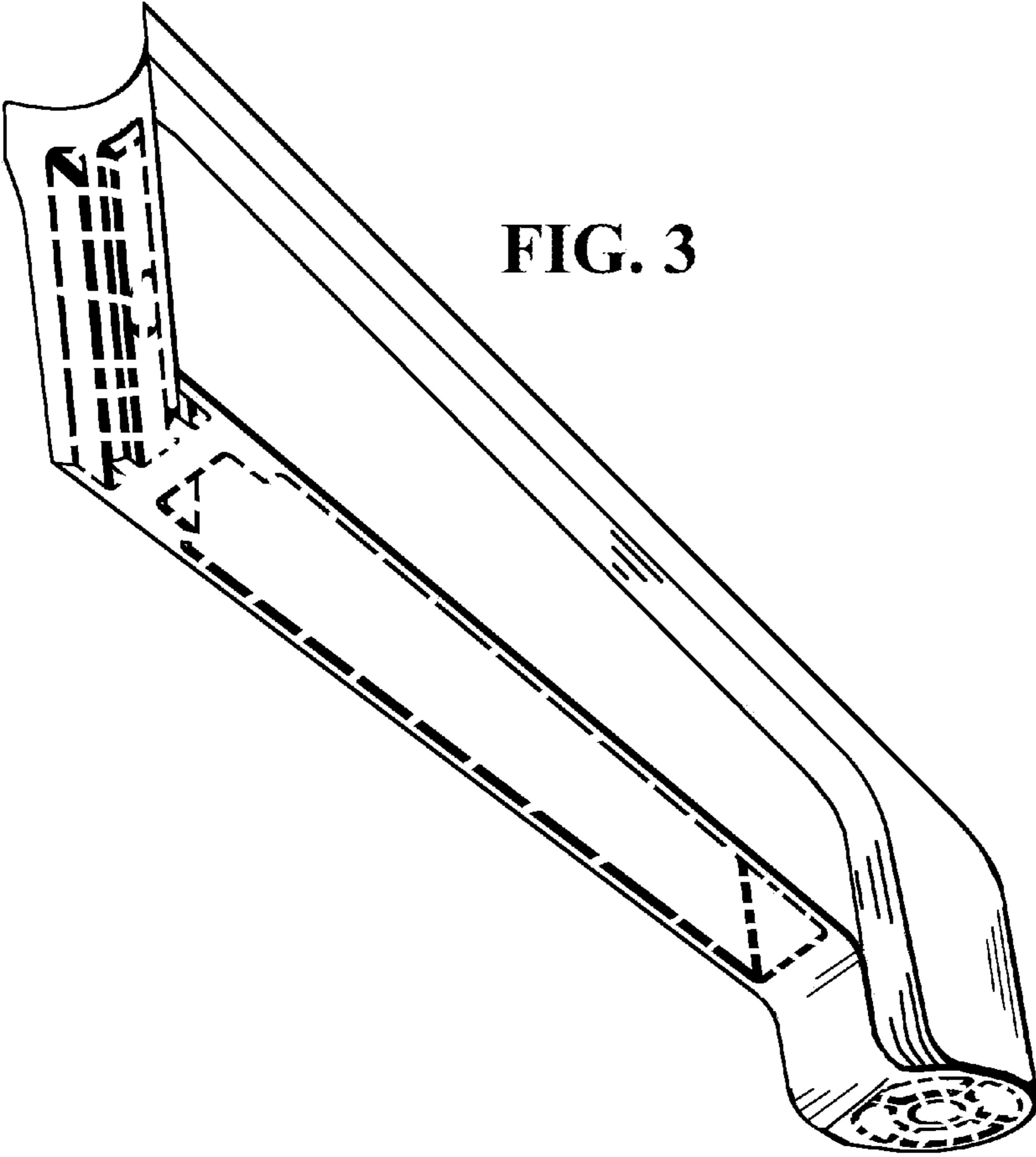

FIG. 3

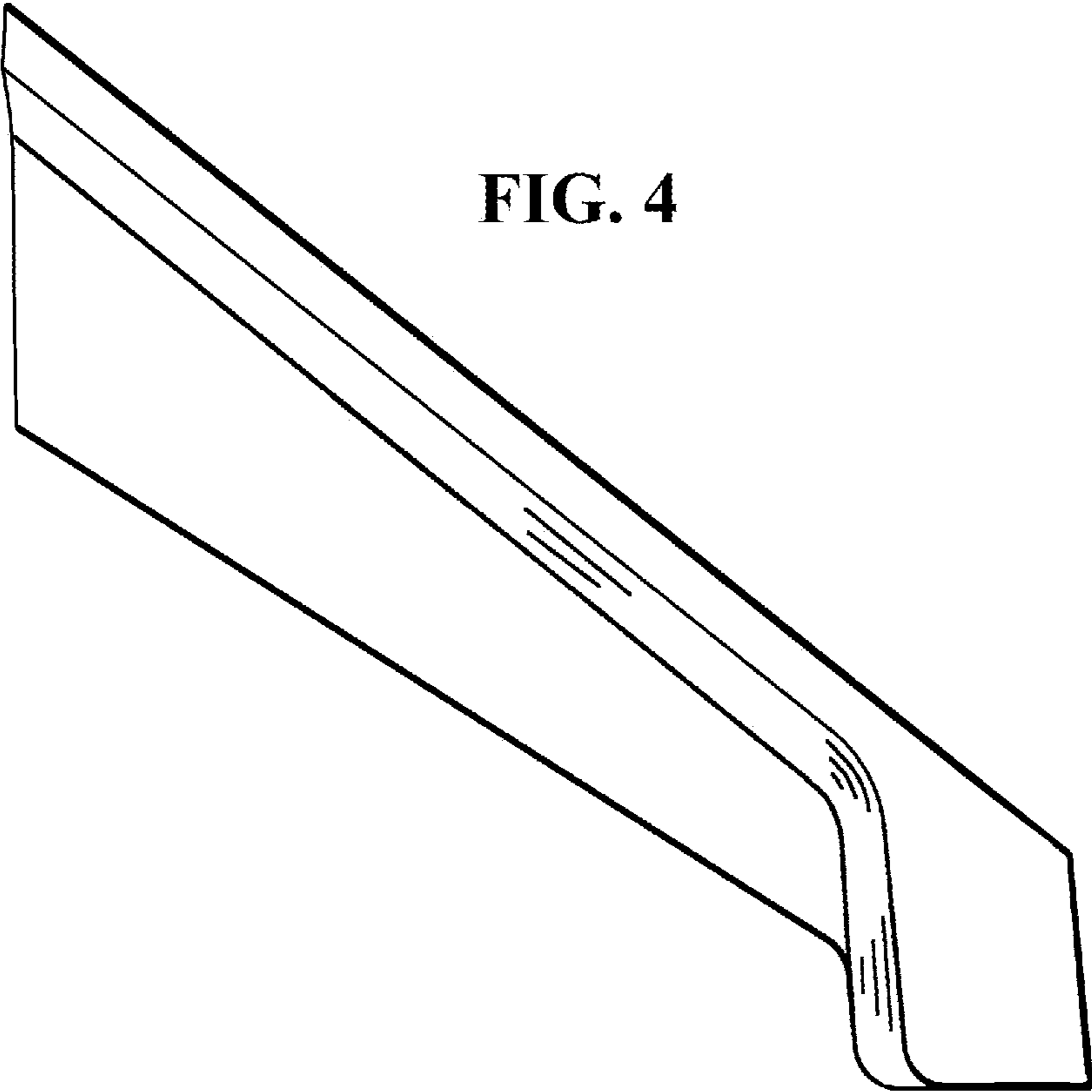

FIG. 4

FIG. 5

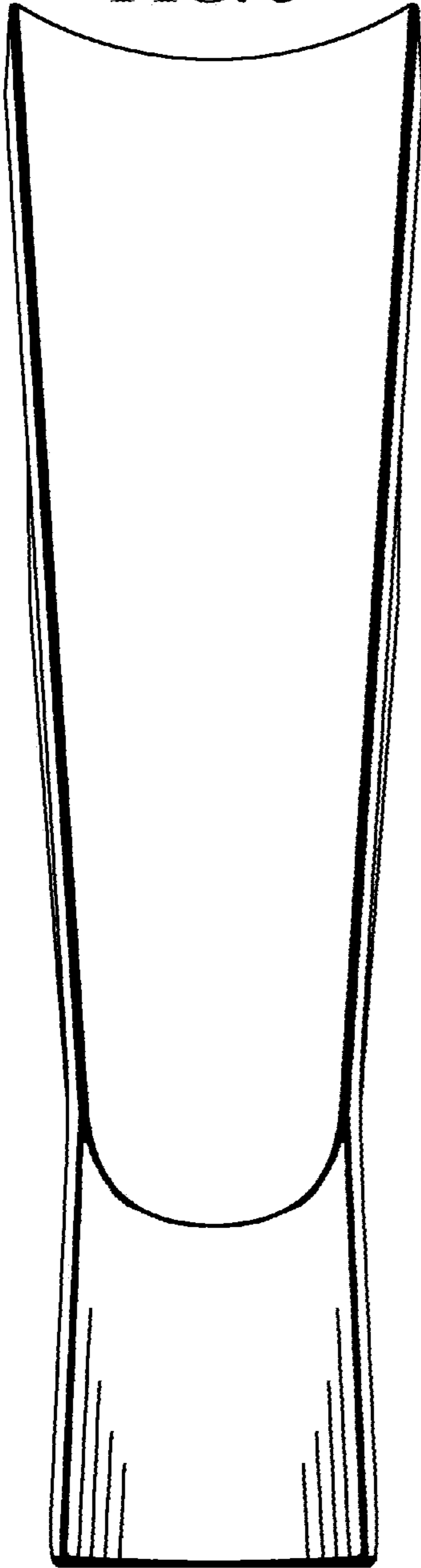

FIG. 6

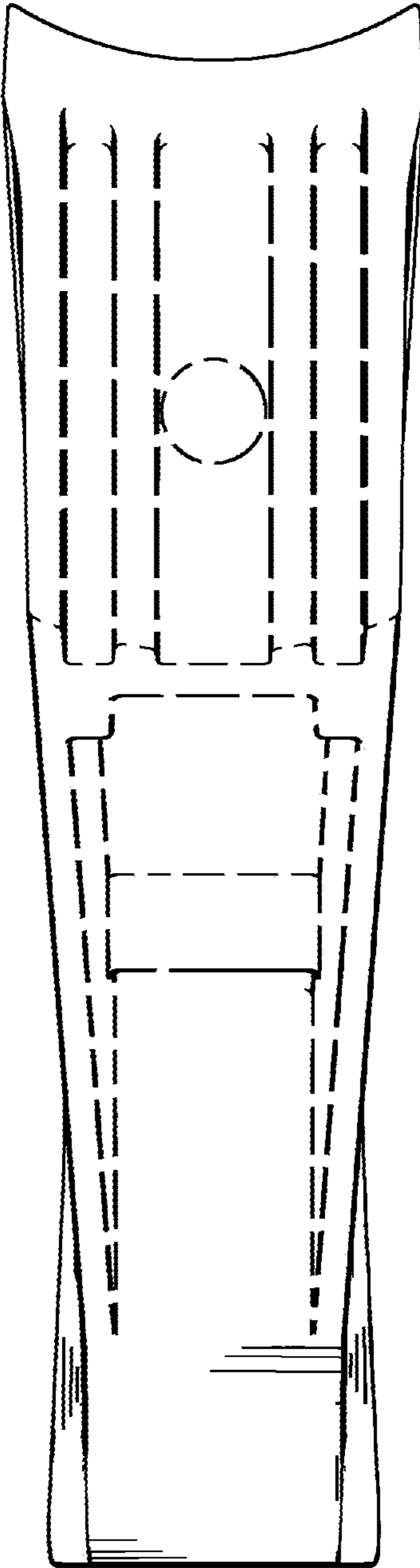

FIG. 7

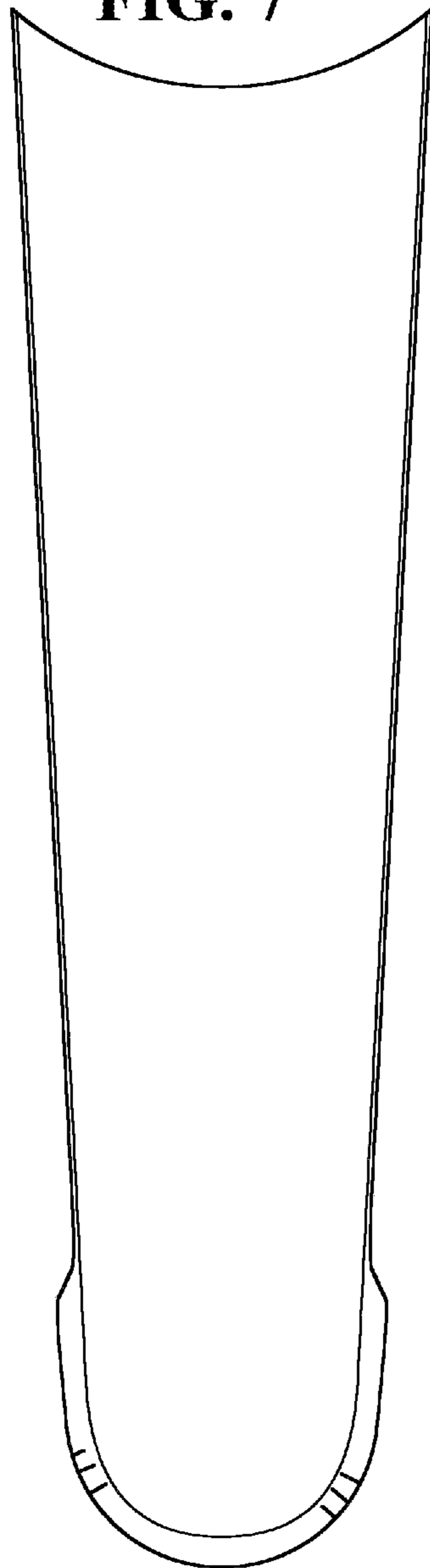
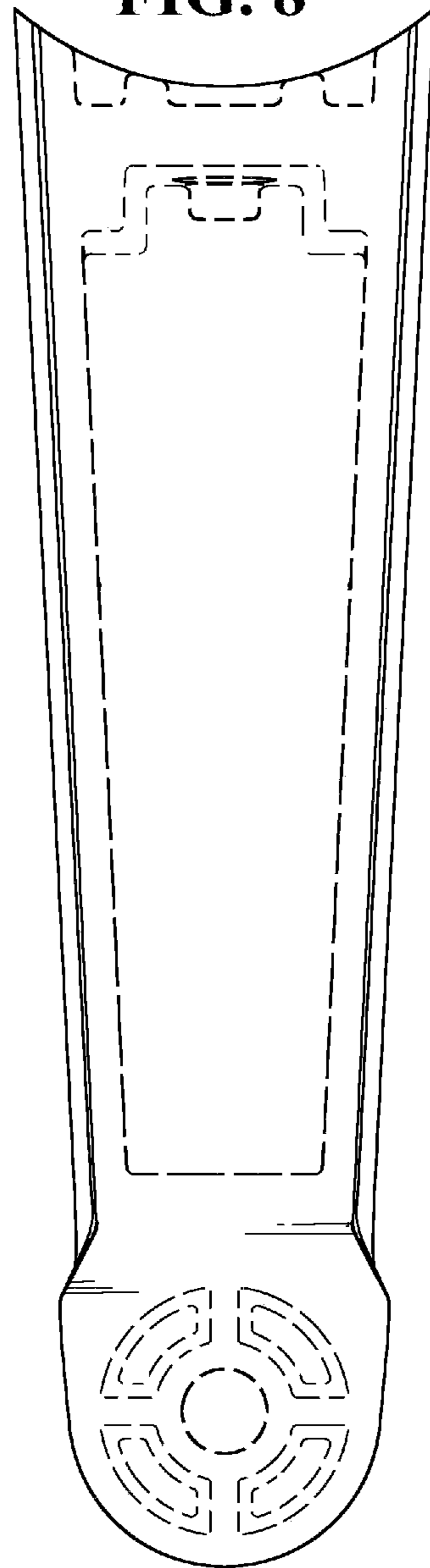

FIG. 8



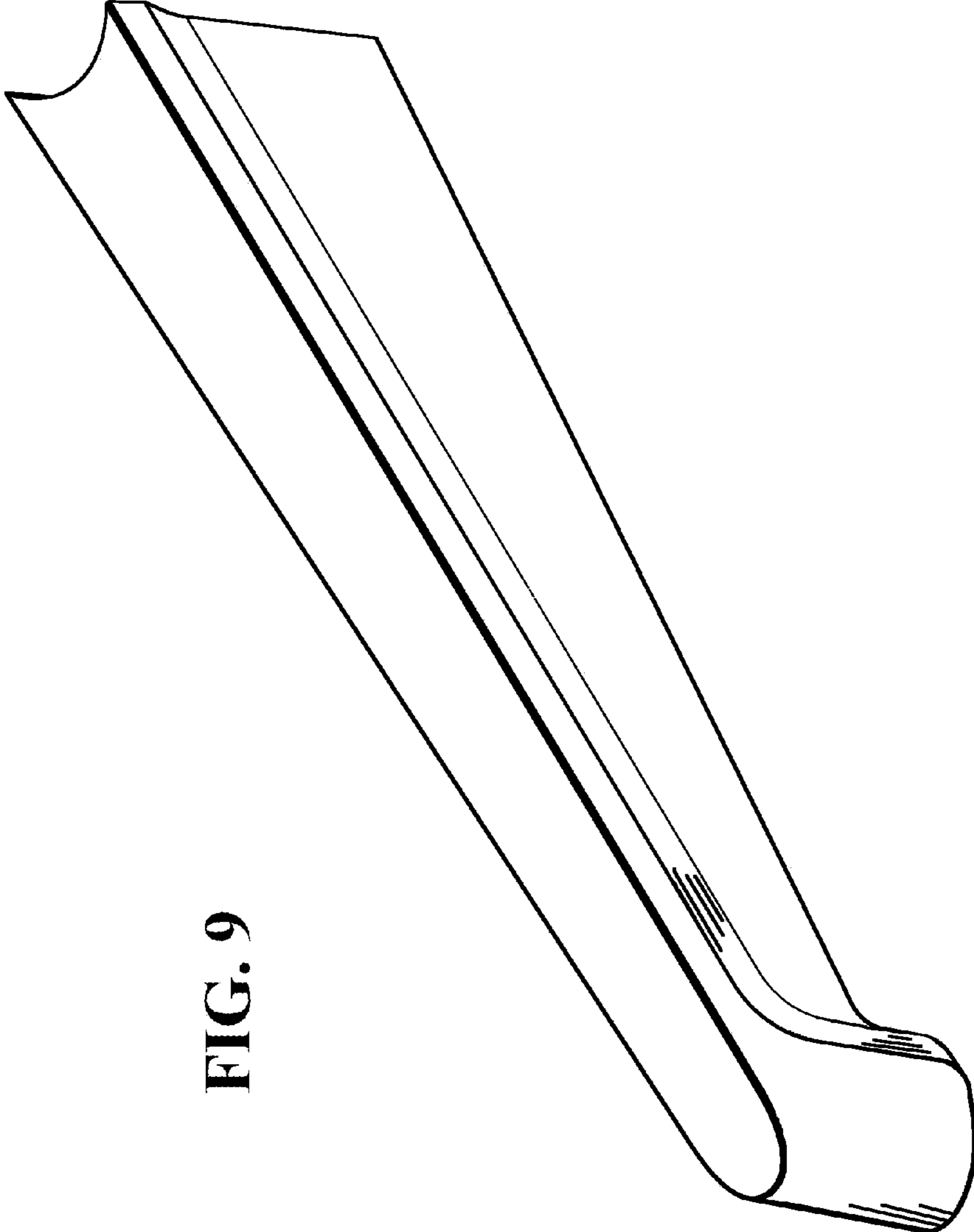

FIG. 9

FIG. 10

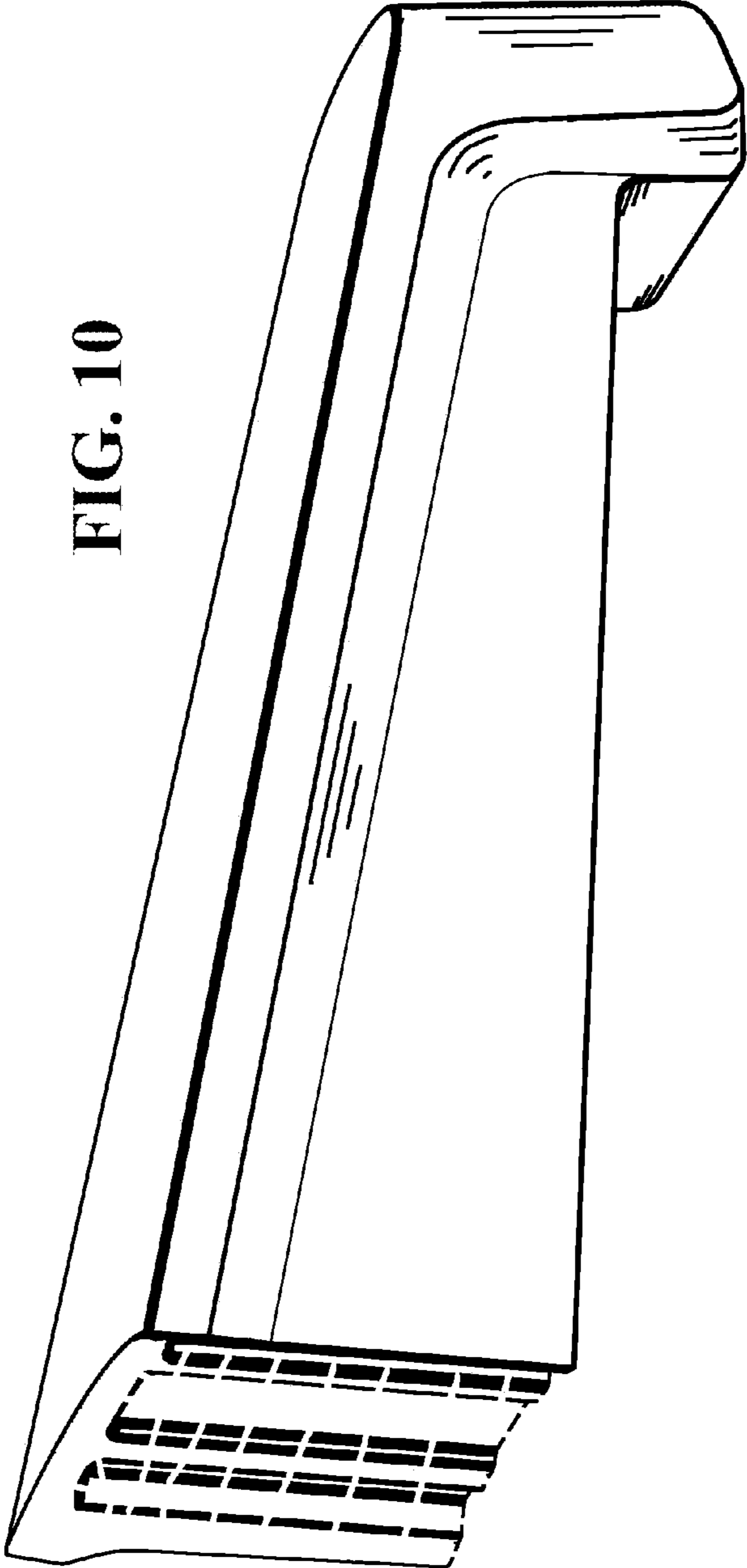

FIG. 11

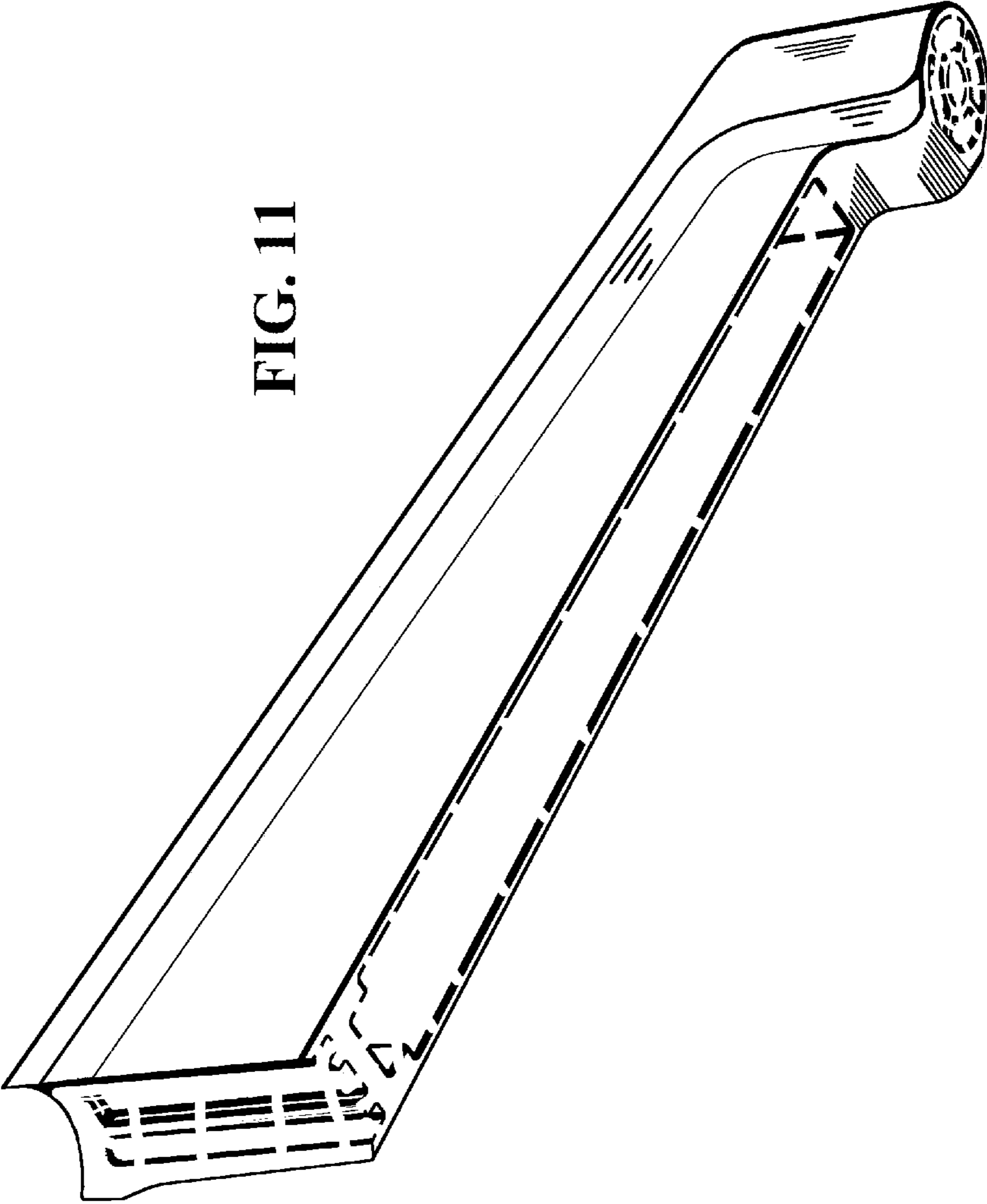

FIG. 12

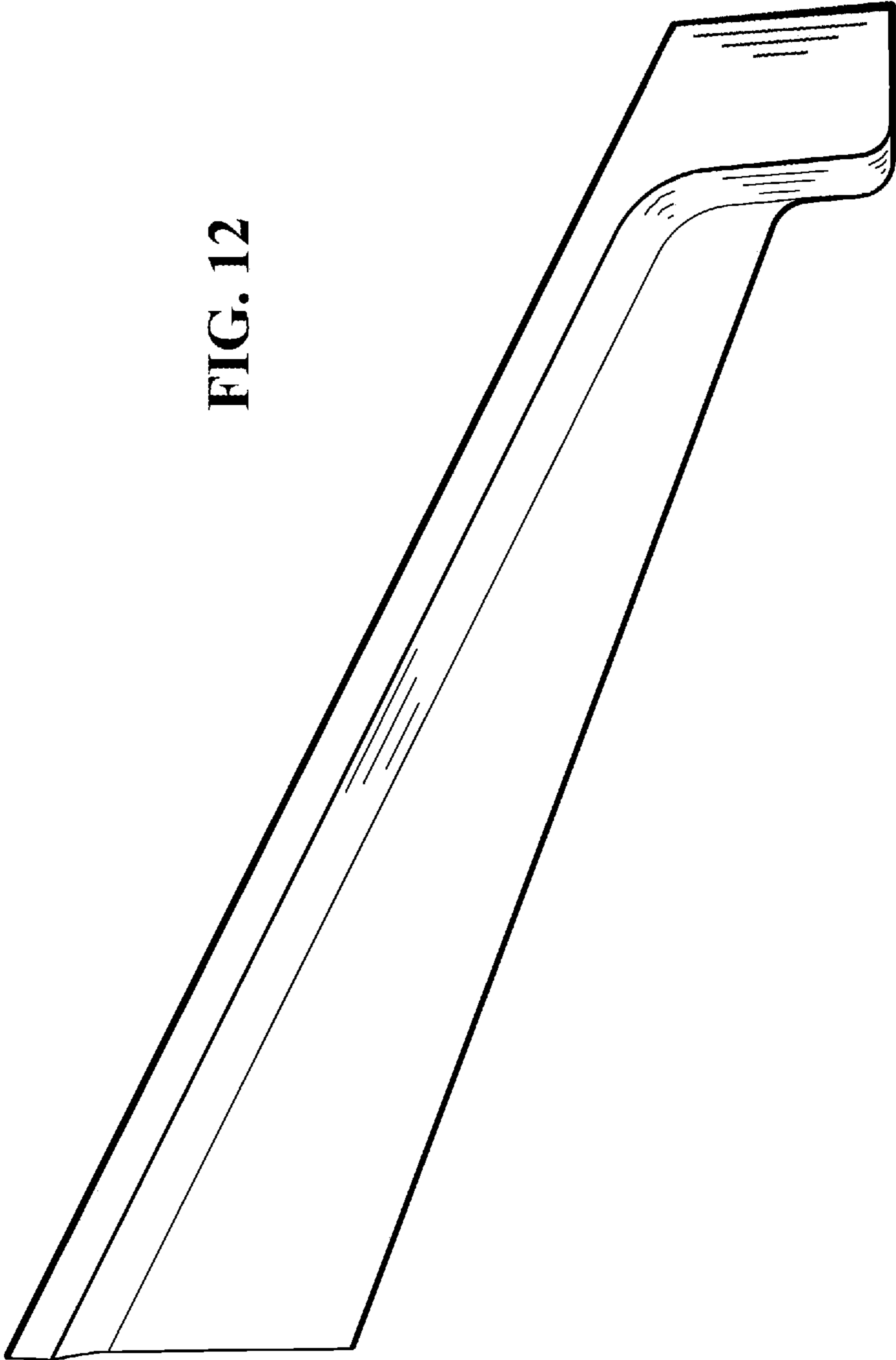

FIG. 13

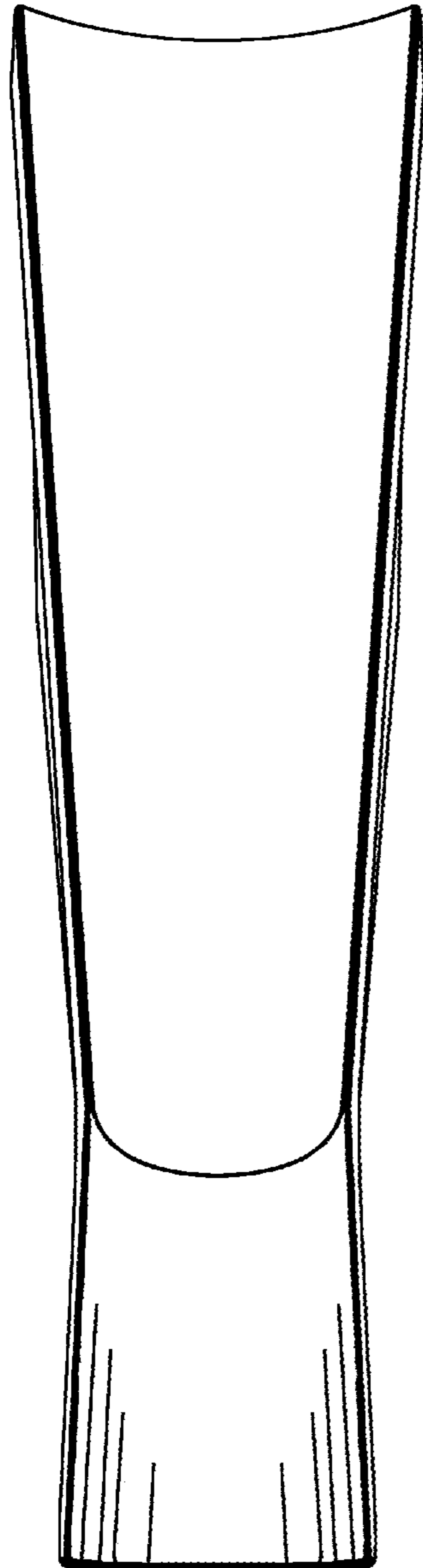

FIG. 14

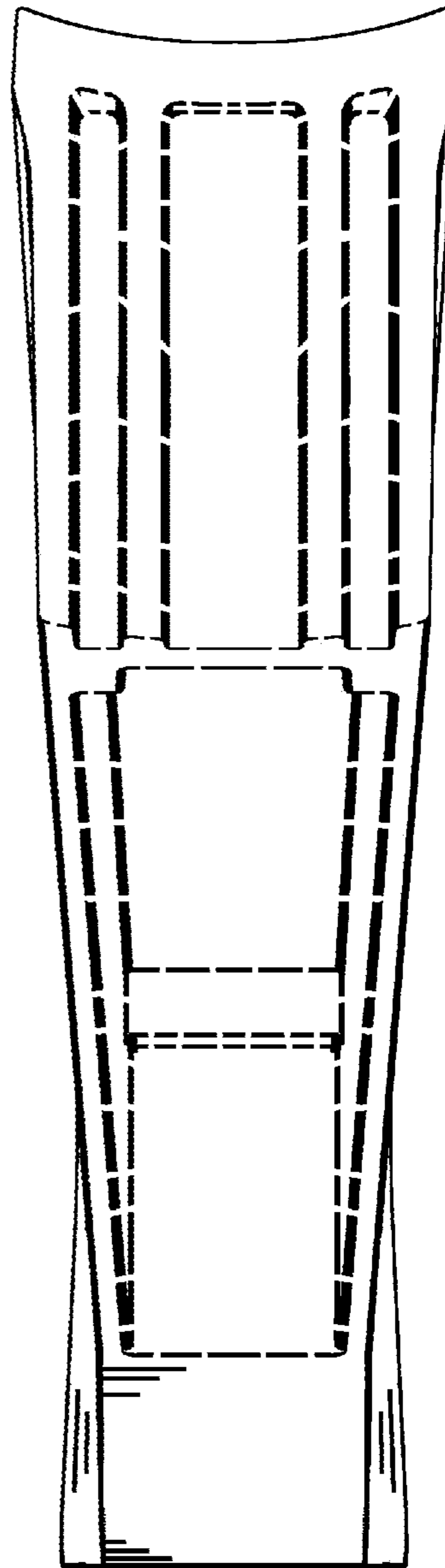

FIG. 15

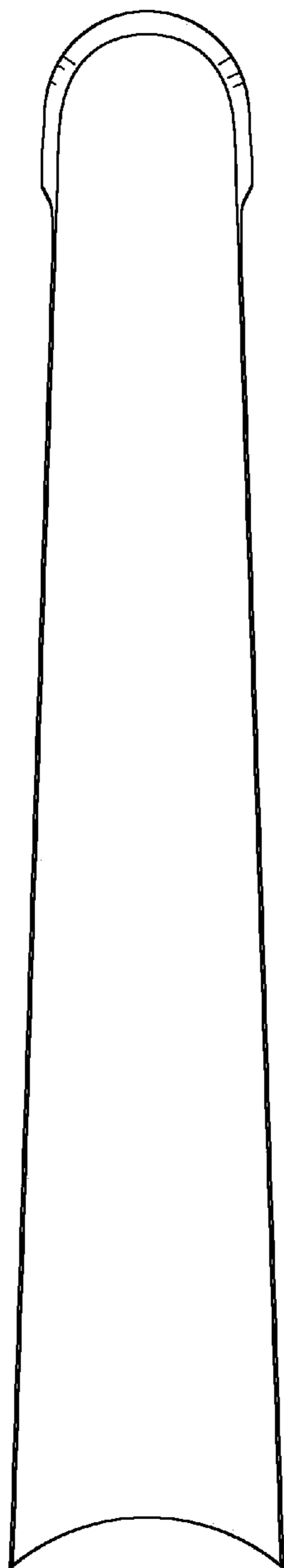
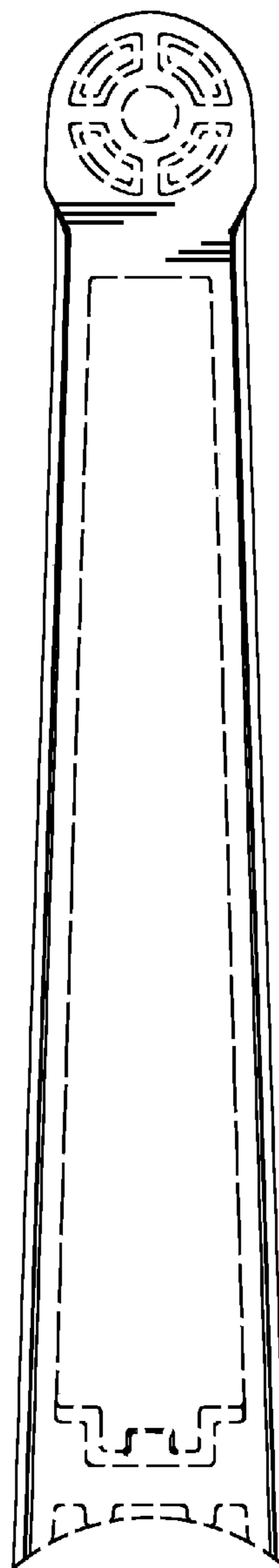

FIG. 16



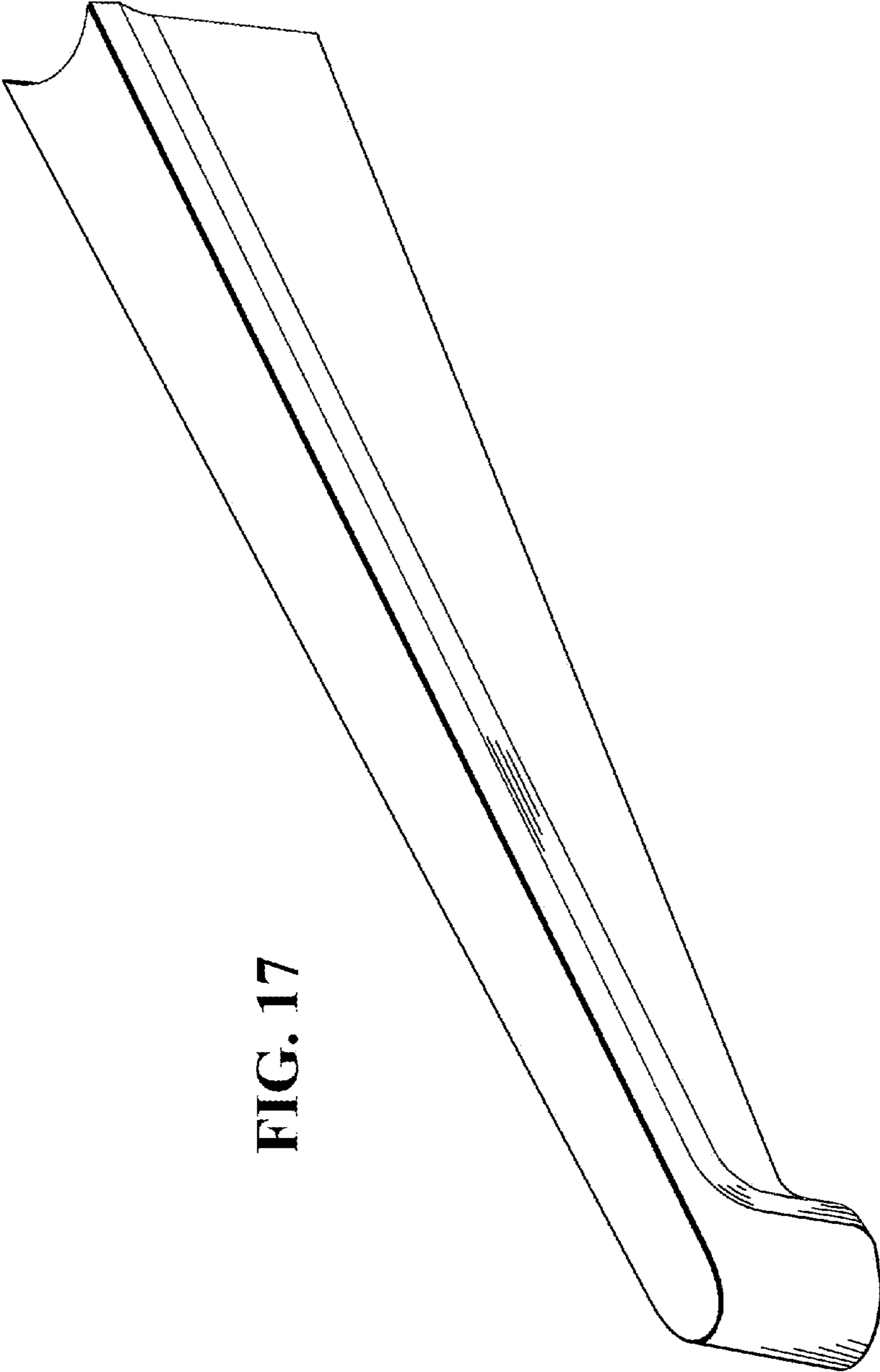

FIG. 17

FIG. 18

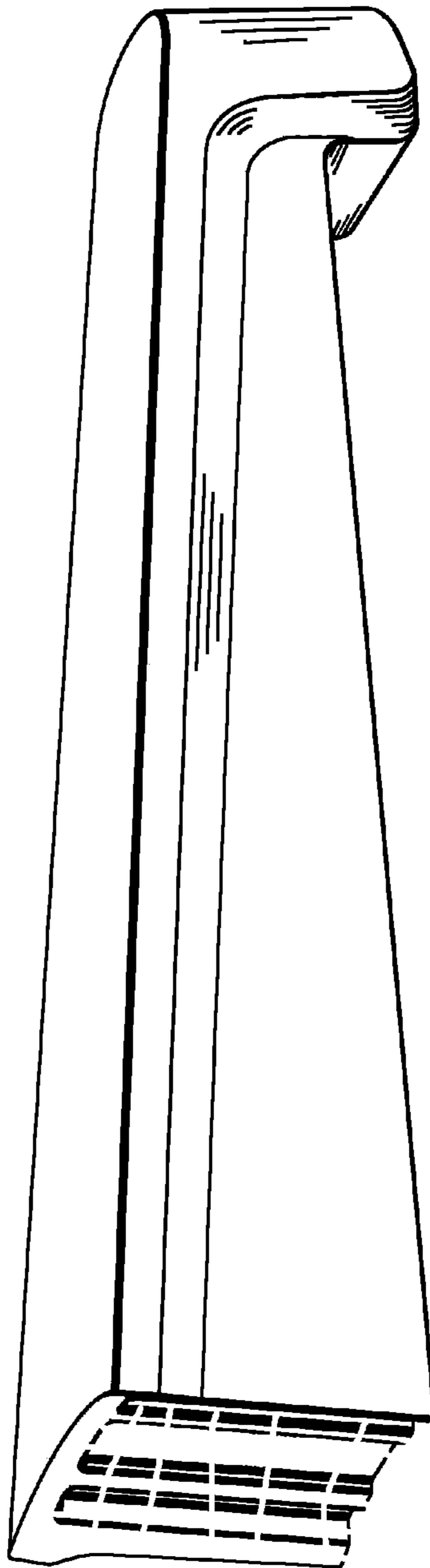

FIG. 19

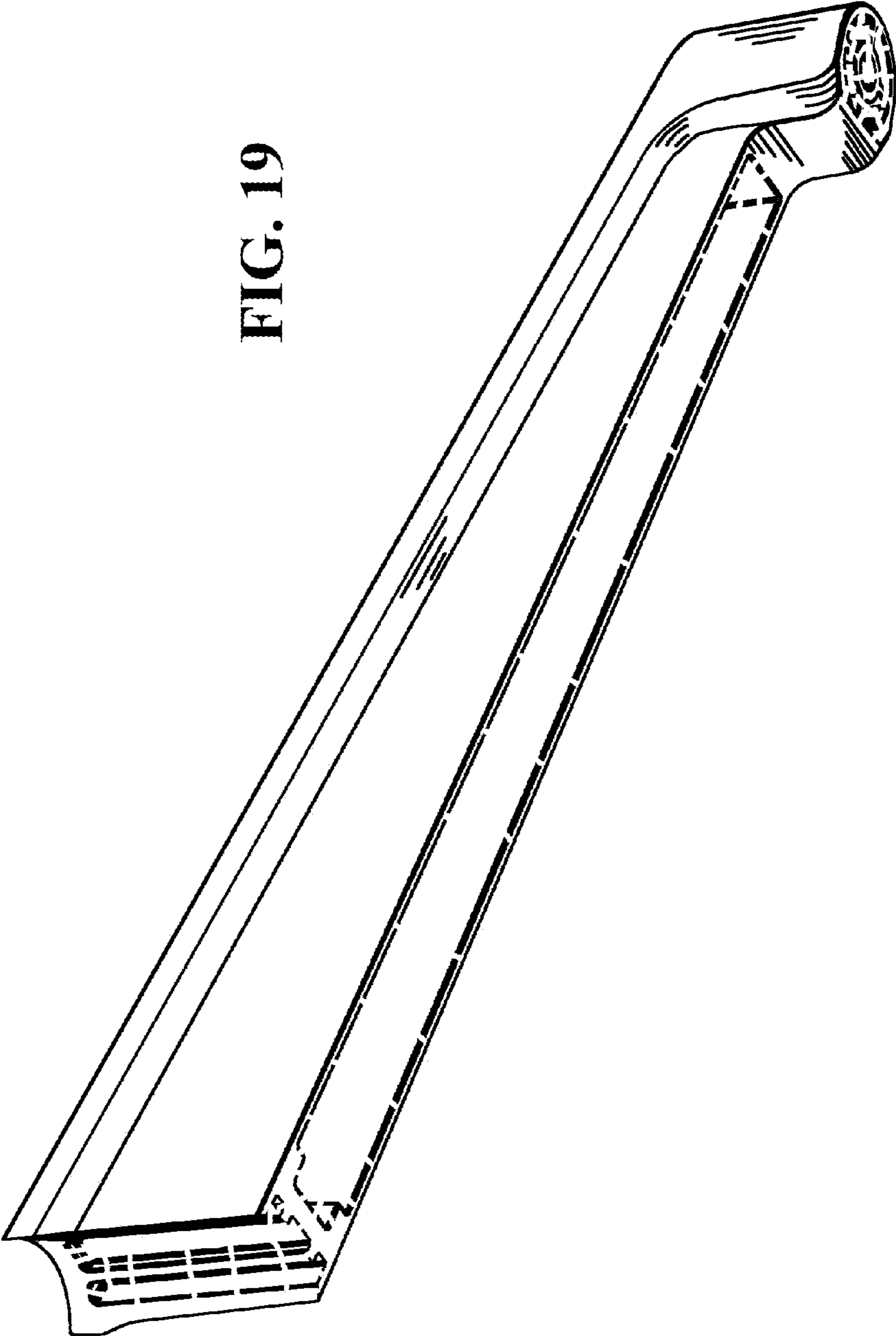

FIG. 20

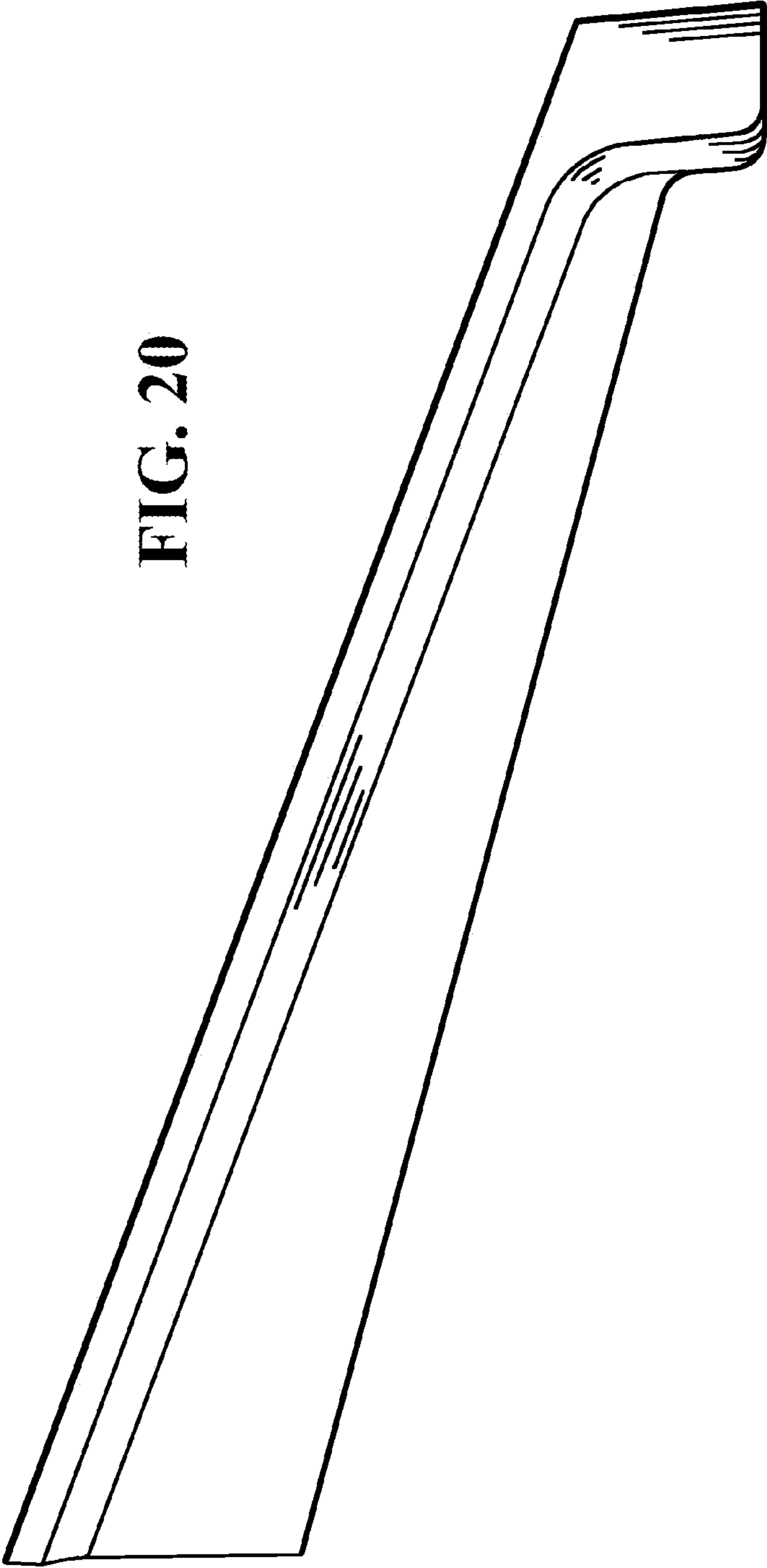

FIG. 21

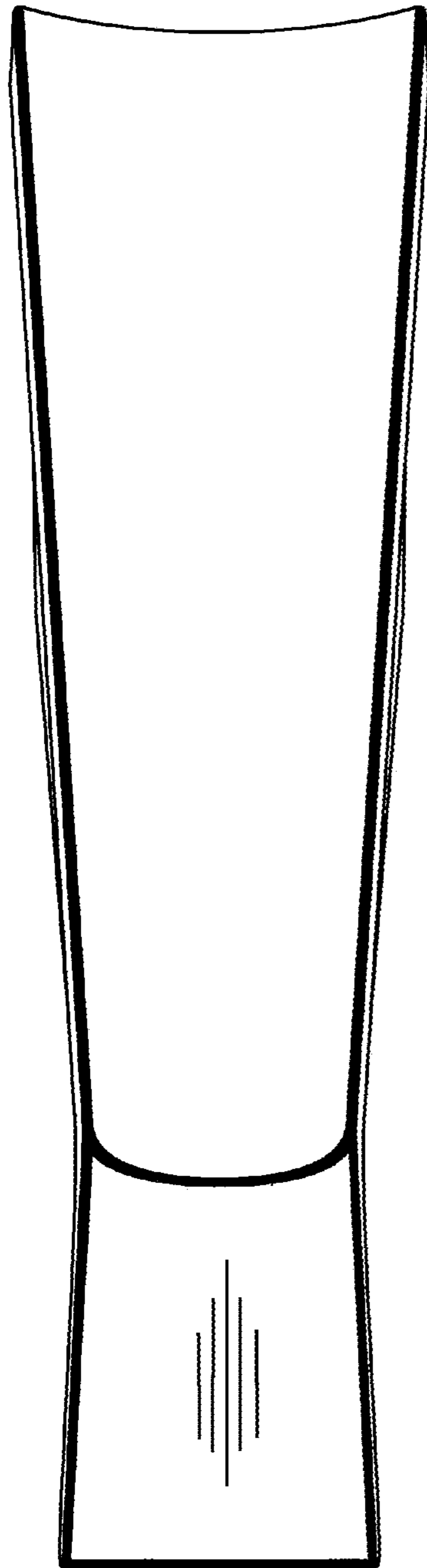

FIG. 22

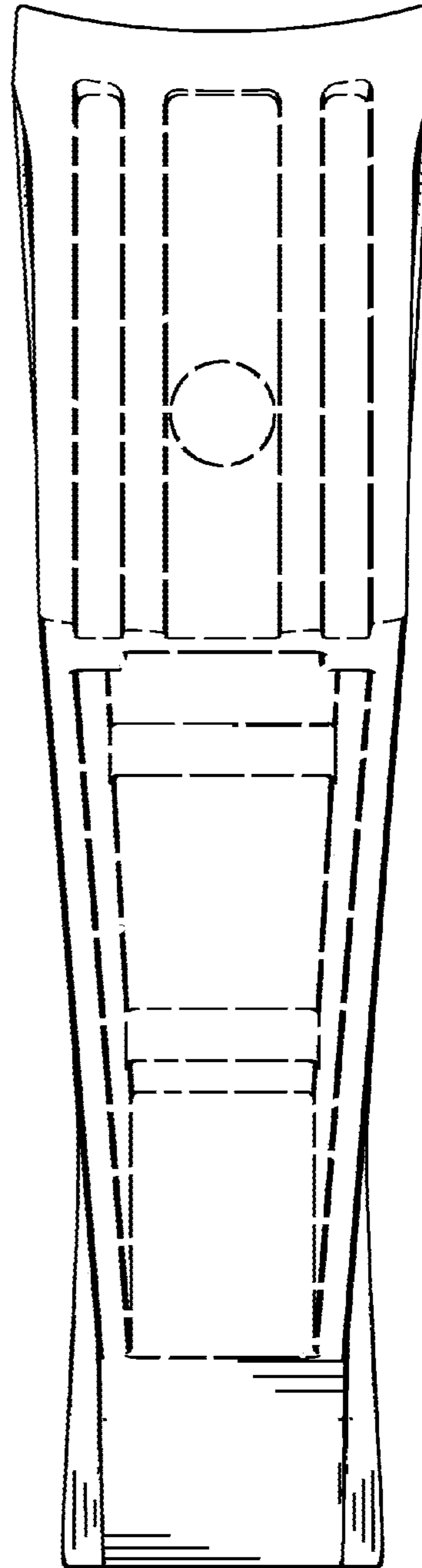

FIG. 23

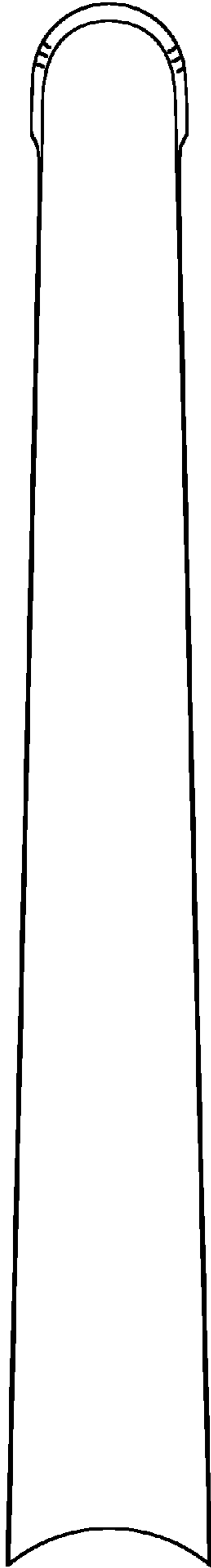
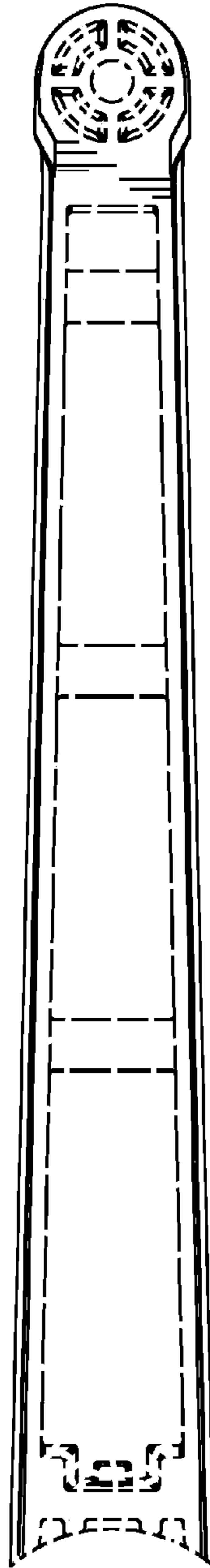

FIG. 24



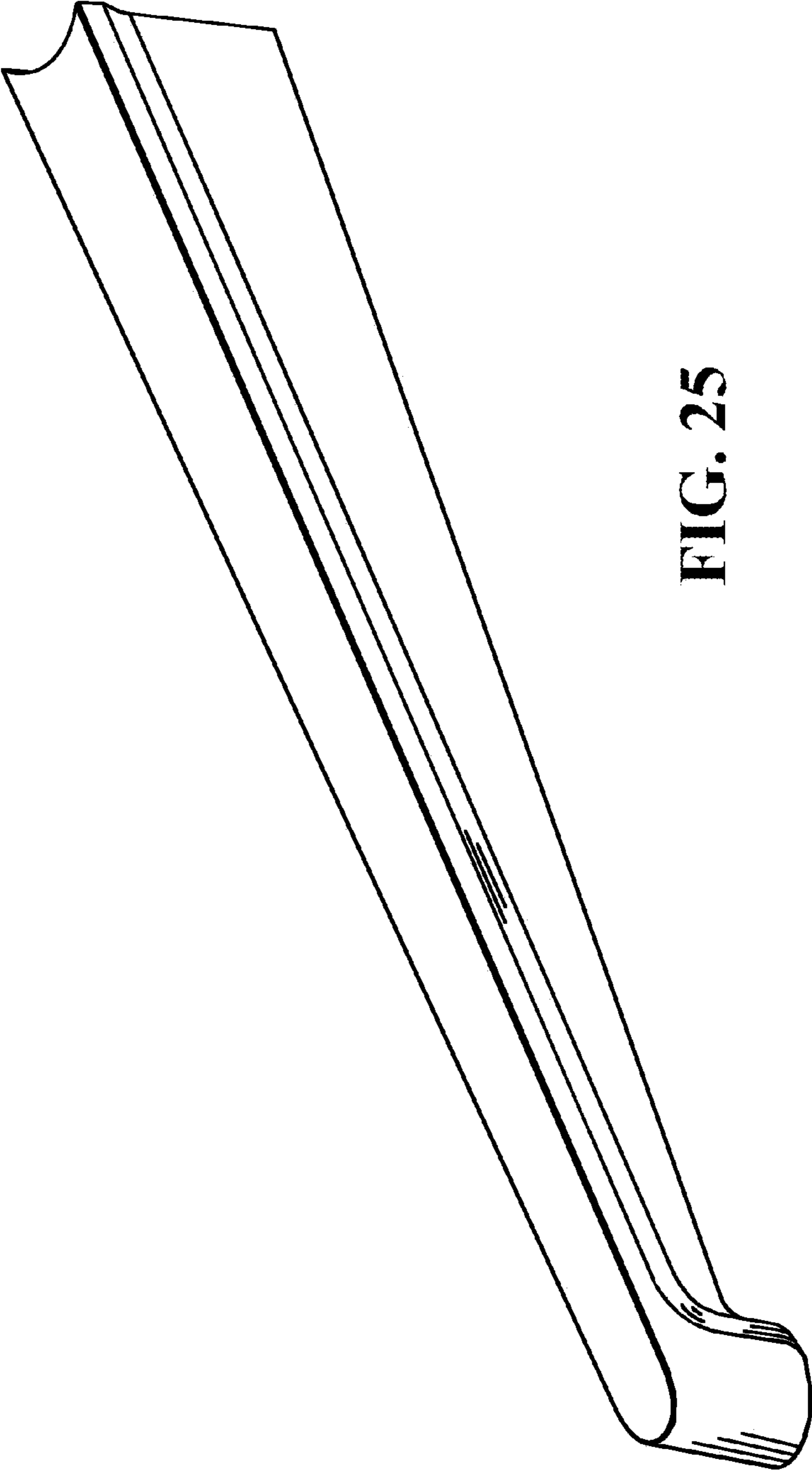

FIG. 25

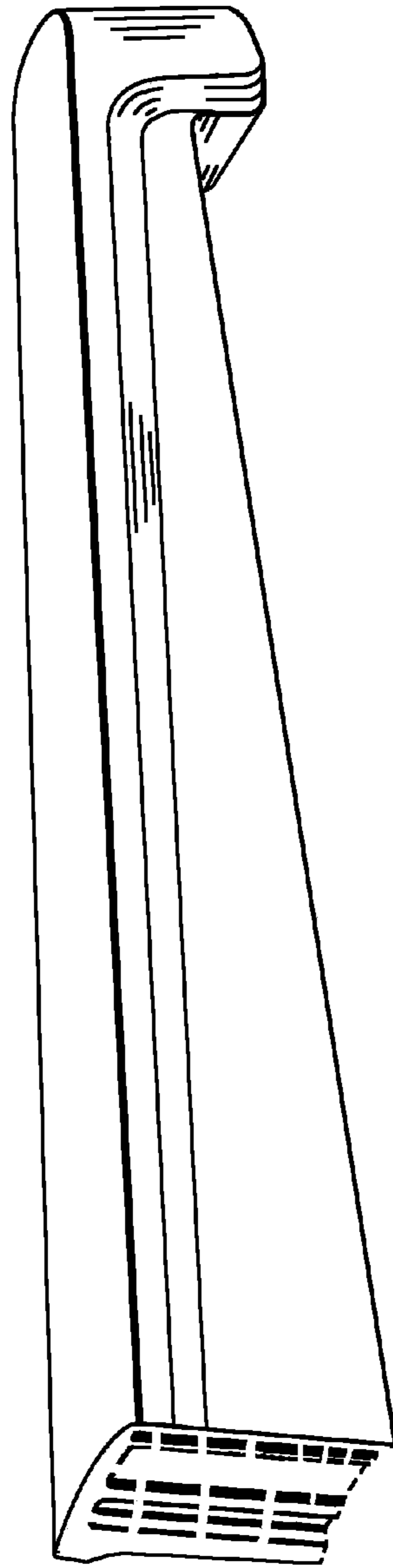

FIG. 26

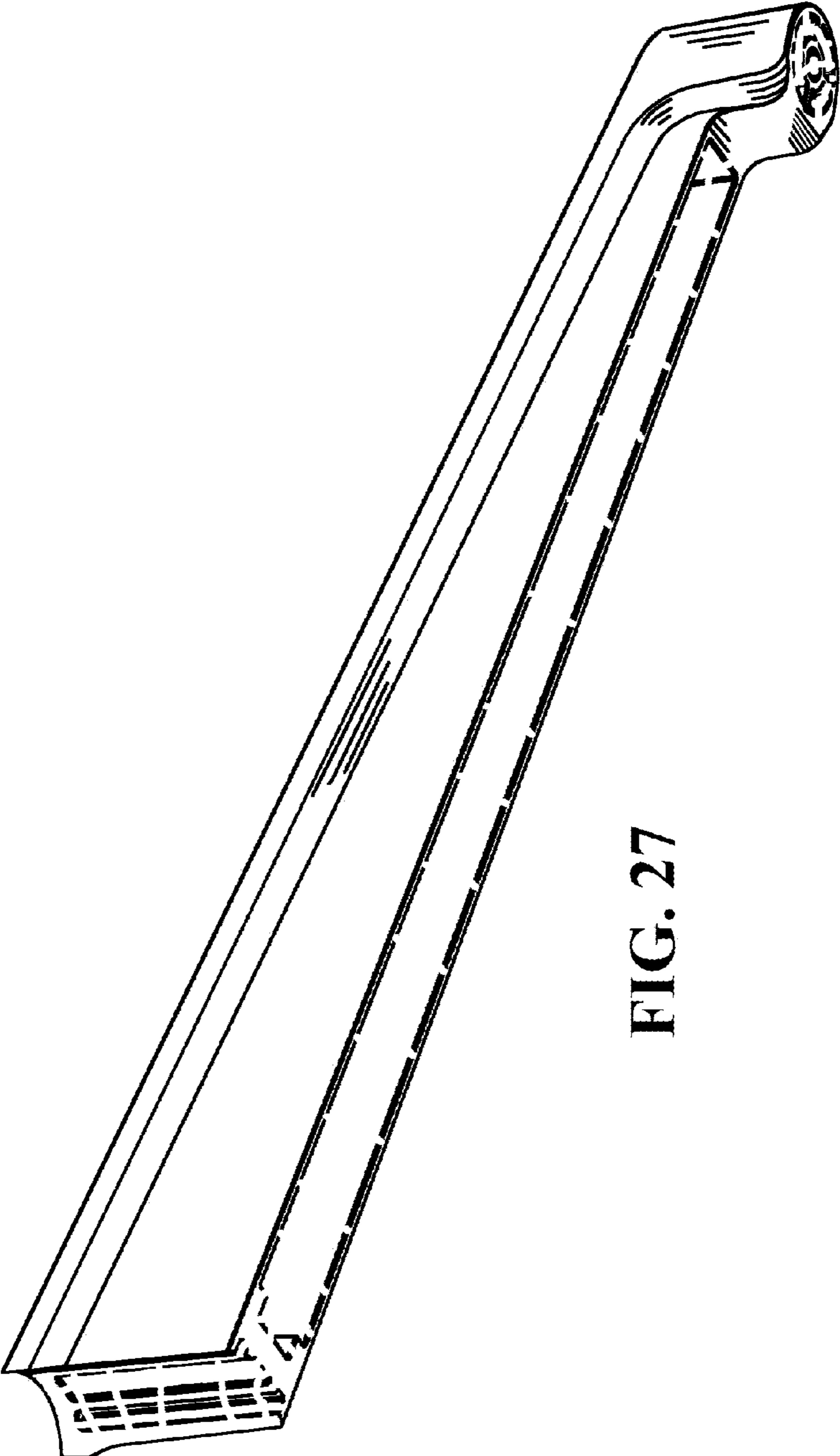

FIG. 27

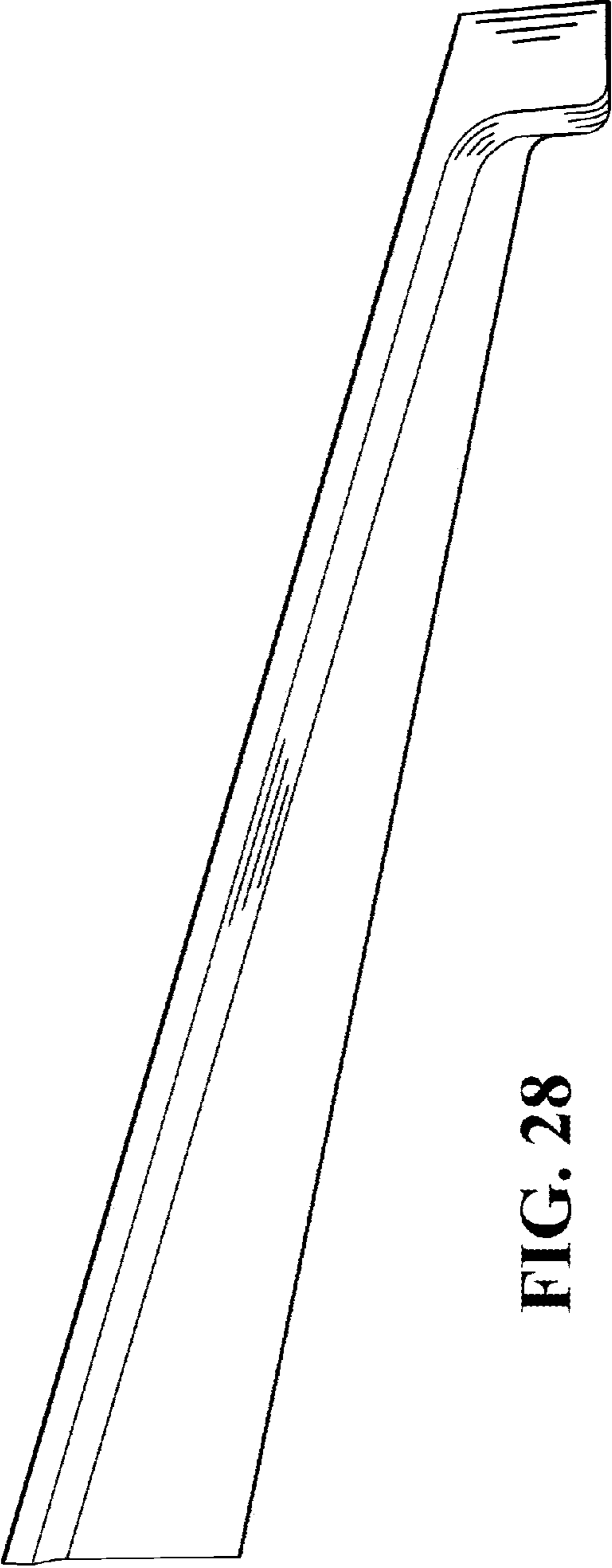

FIG. 28

FIG. 29

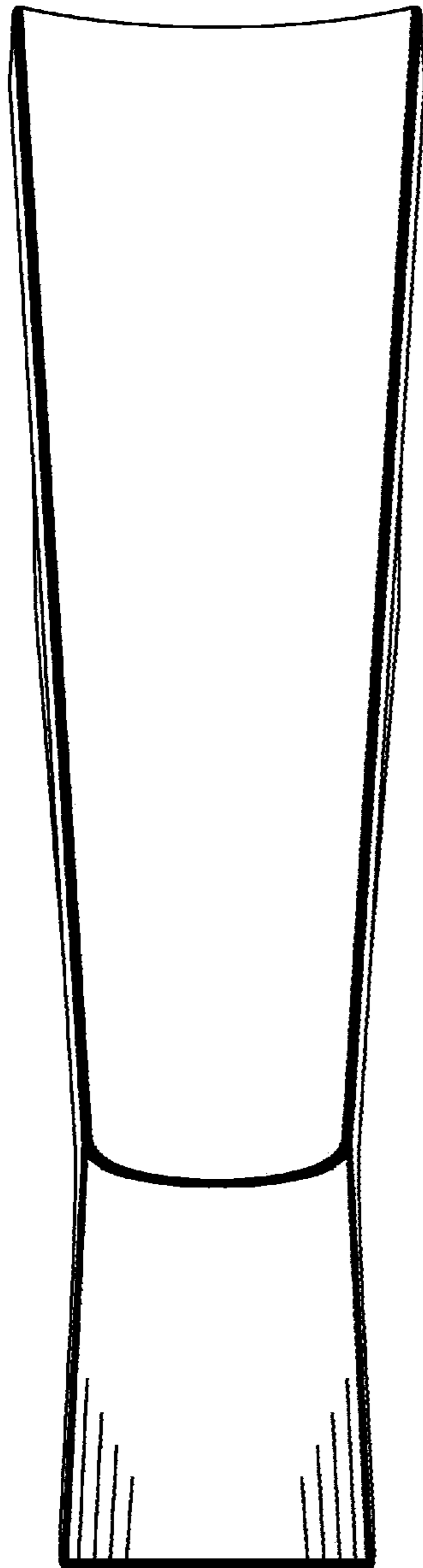

FIG. 30

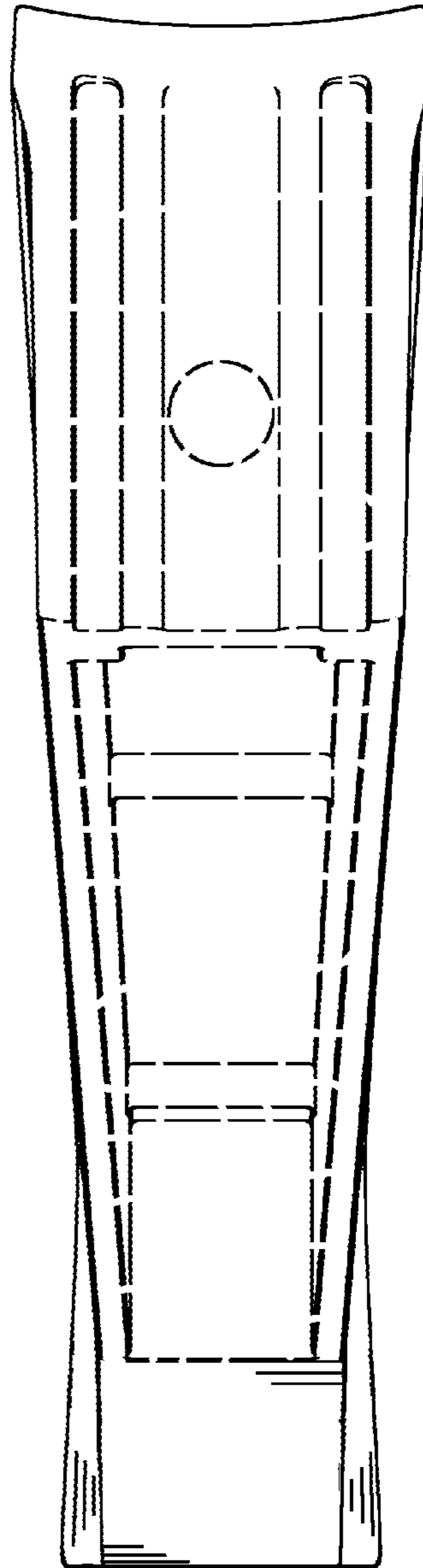

FIG. 31

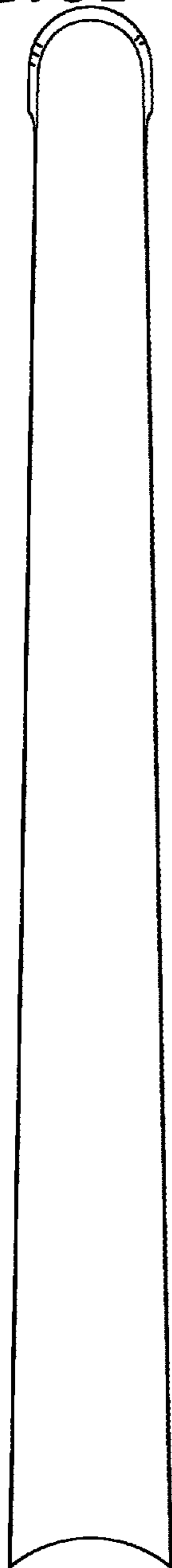
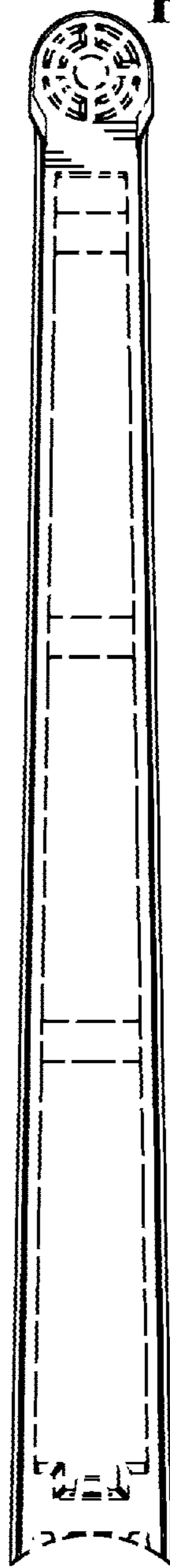

FIG. 32



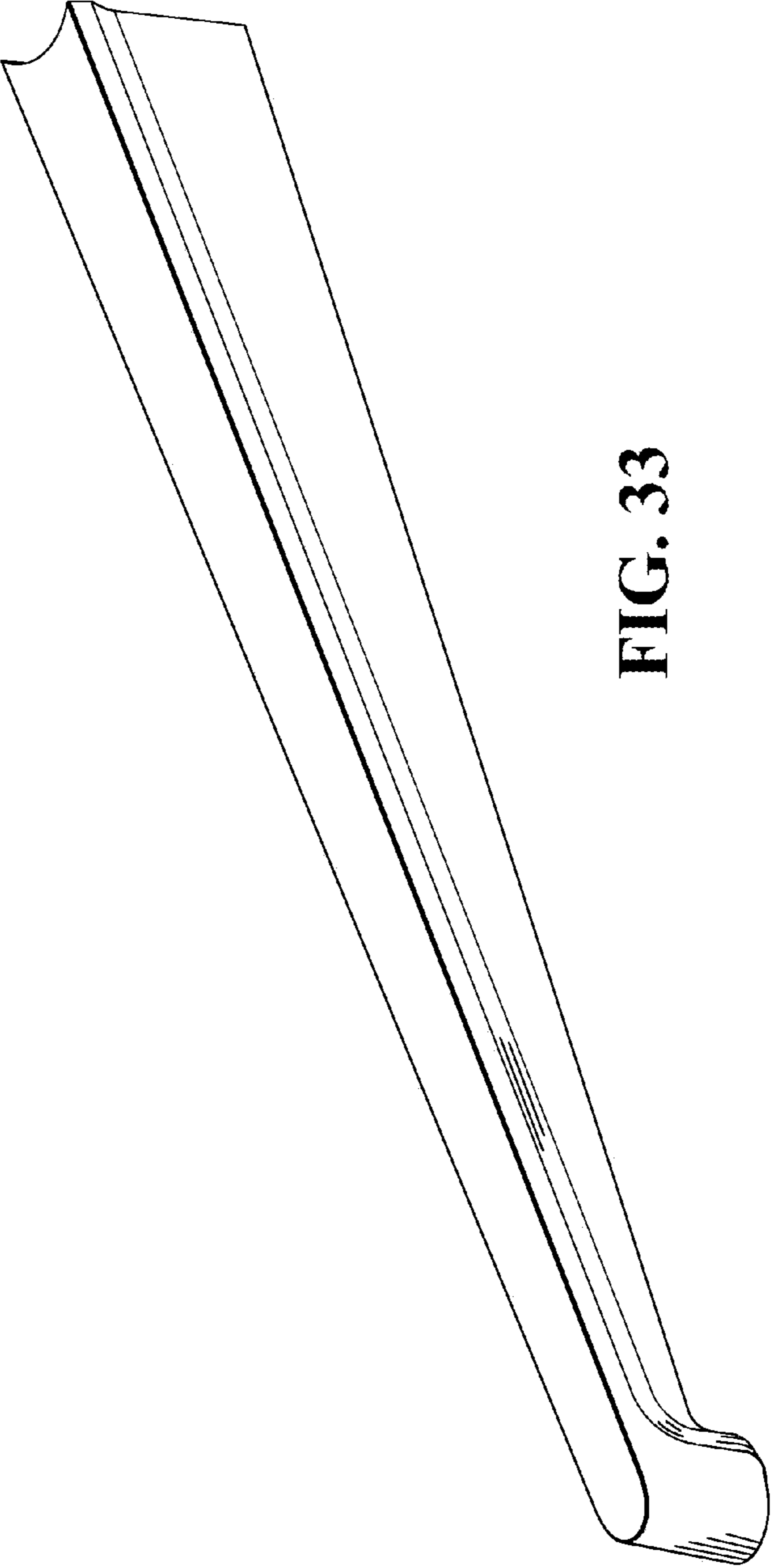

FIG. 33

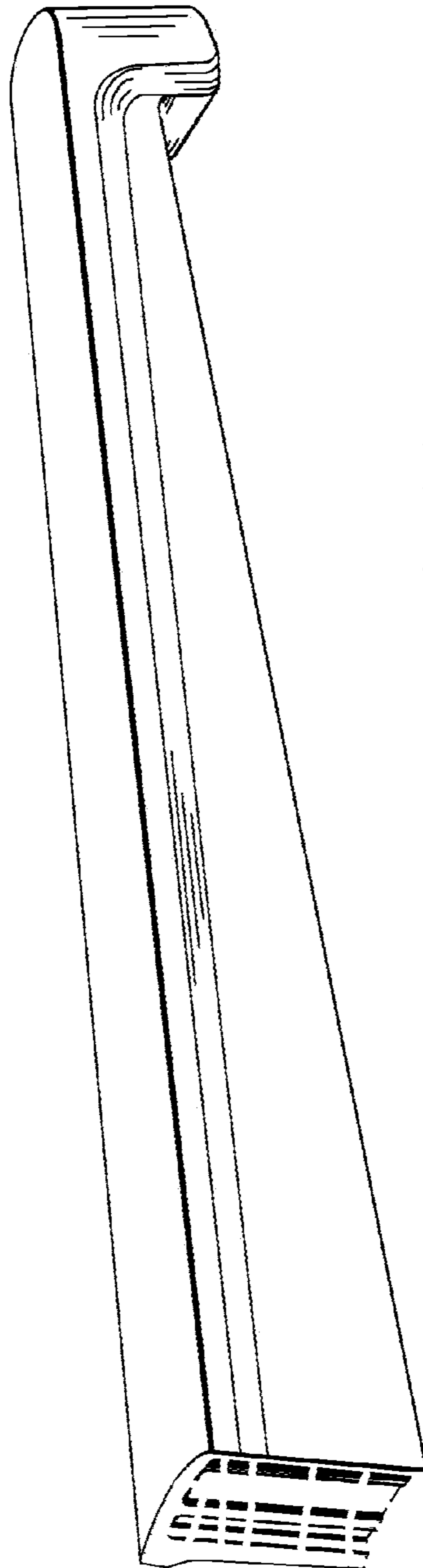

FIG. 34

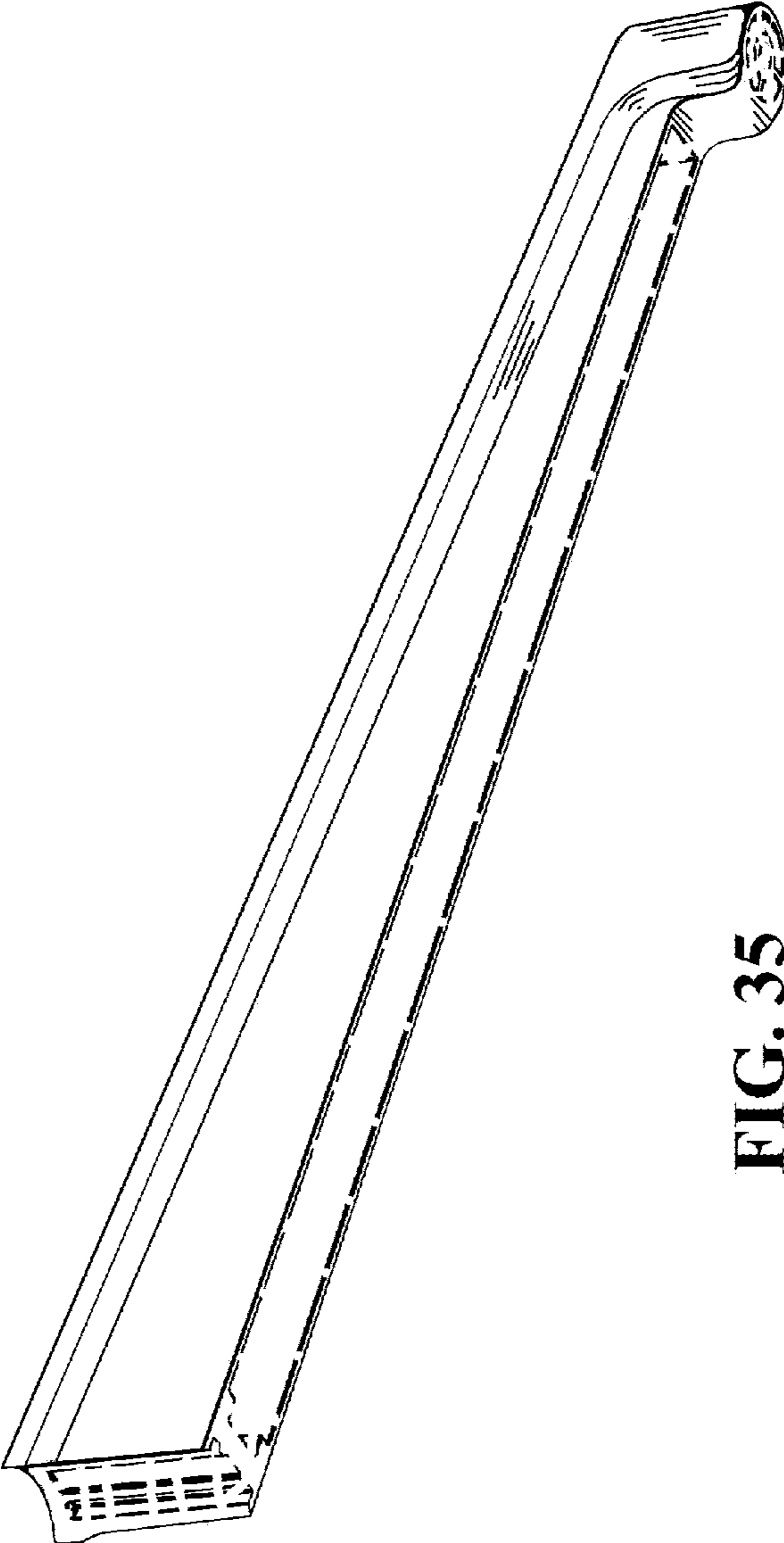

FIG. 35

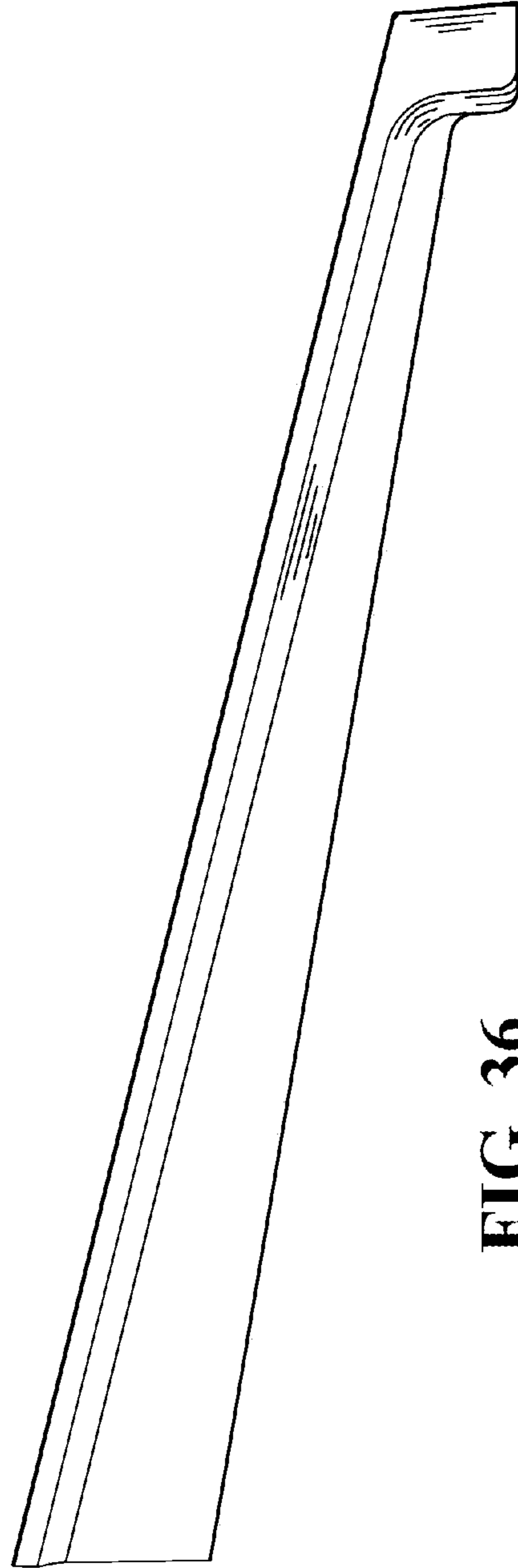

FIG. 36

FIG. 37

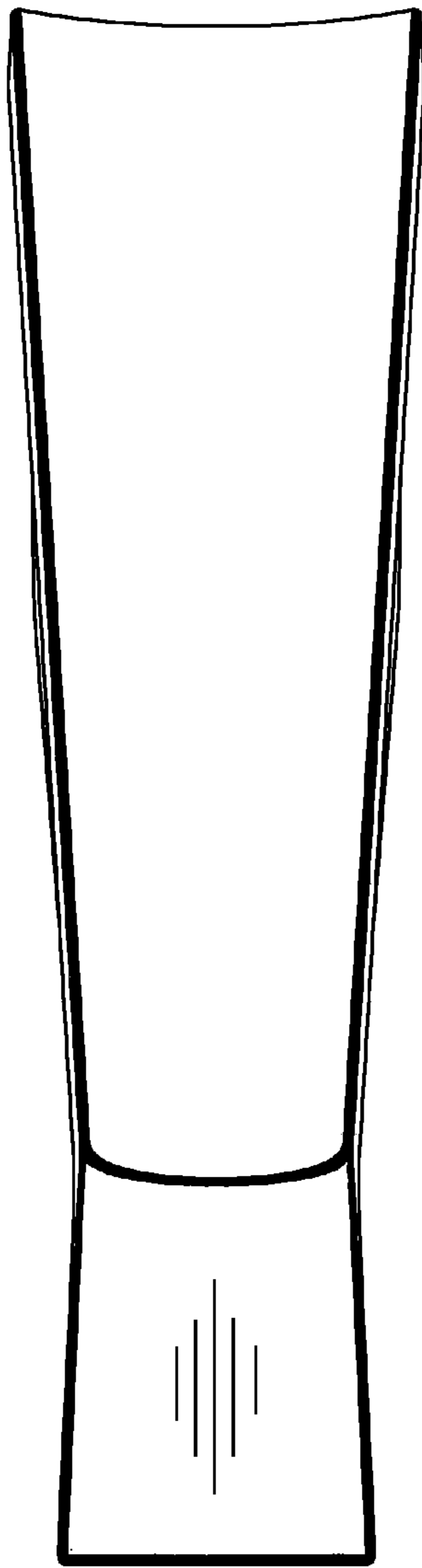

FIG. 38

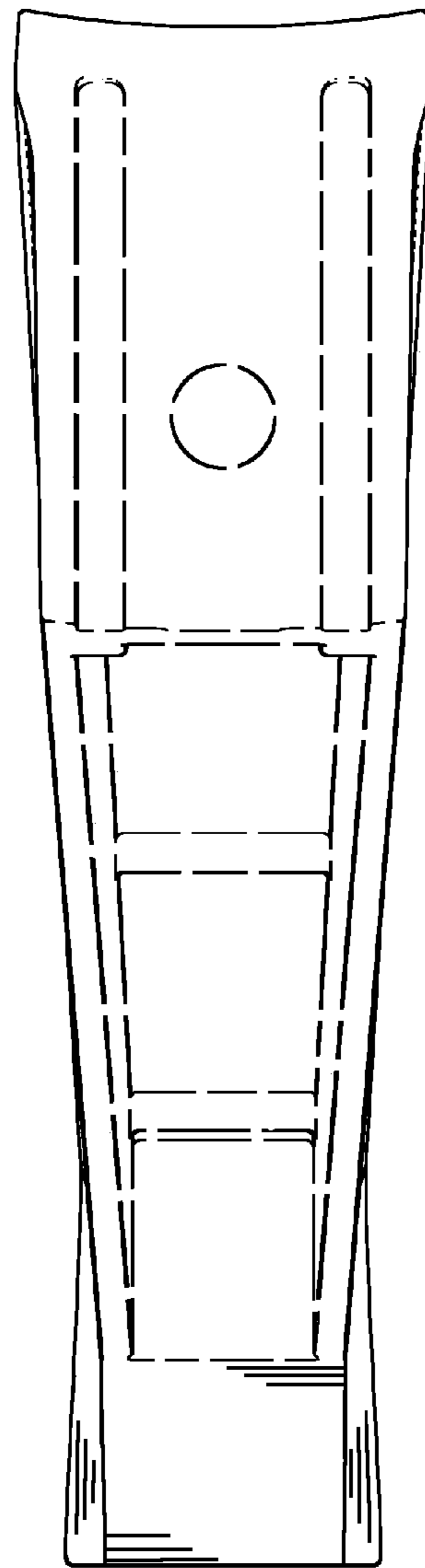

FIG. 39

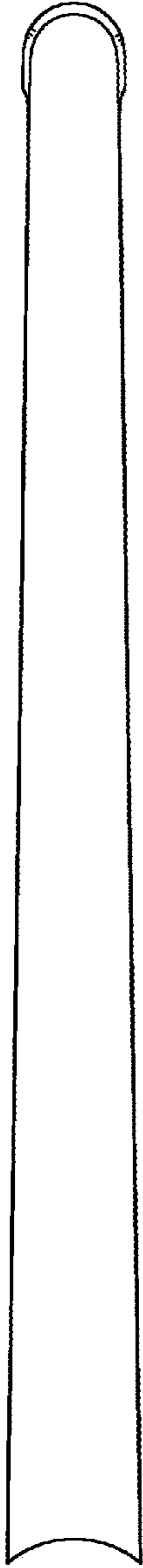
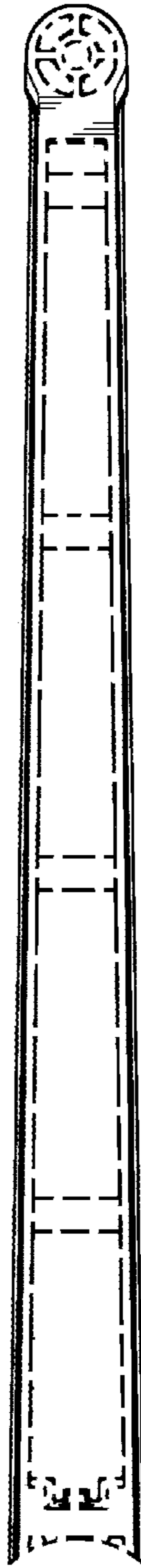

FIG. 40



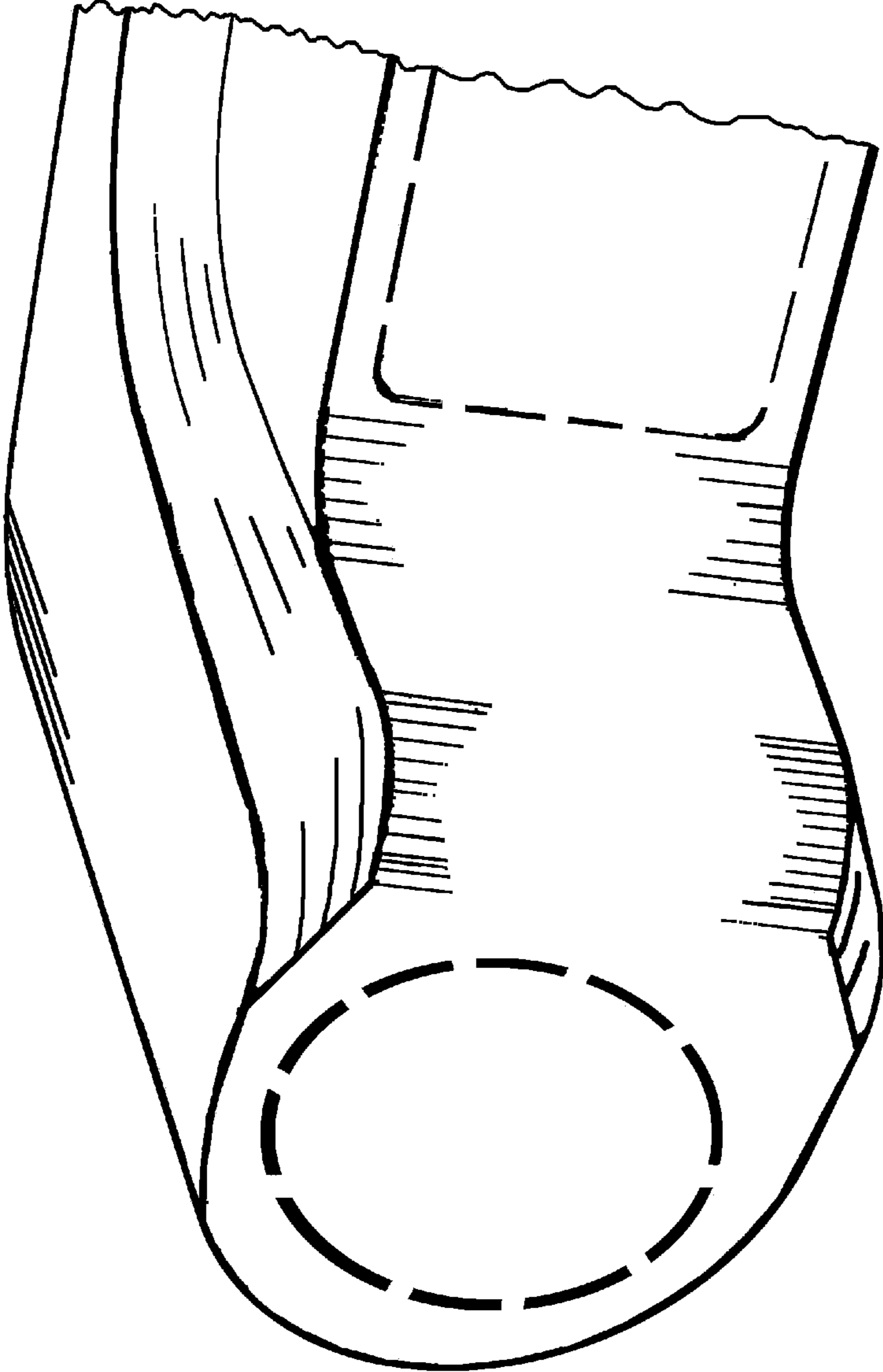

FIG. 41