



US00D763557S

(12) **United States Design Patent**
Gavrieli et al.

(10) **Patent No.:** **US D763,557 S**

(45) **Date of Patent:** **** *Aug. 16, 2016**

(54) **SINGLE-SOLE SHOE WITH PURPLE SOLE**

(71) Applicant: **Gavrieli Brands, LLC**, Beverly Hills, CA (US)

(72) Inventors: **Kfir Gavrieli**, Los Angeles, CA (US);
Dikla Gavrieli, Los Angeles, CA (US)

(73) Assignee: **Gavrieli Brands LLC**, Beverly Hills, CA (US)

(*) Notice: This patent is subject to a terminal disclaimer.

(**) Term: **14 Years**

(21) Appl. No.: **29/493,541**

(22) Filed: **Jun. 10, 2014**

(51) **LOC (10) Cl.** **02-04**

(52) **U.S. Cl.**
USPC **D2/939**

(58) **Field of Classification Search**
USPC D2/896, 900, 919-921, 925, 939, 947,
D2/950, 969, 971; 36/1, 83, 8.1-8.3, 9 R,
36/45-58, 104, 108, 76 R
CPC A43B 21/00; A43B 21/02; A43B 21/06;
A43B 9/14; A43B 1/0045; A43B 13/10;
A43B 13/12; A43B 23/06; A43B 23/07;
A43B 1/0036; A43B 5/12

See application file for complete search history.

(56) **References Cited**

U.S. PATENT DOCUMENTS

249,086 A 11/1881 Pienovi
773,850 A 11/1904 Cooper et al.

(Continued)

FOREIGN PATENT DOCUMENTS

DE 20 2006 000230 U1 5/2007
GB 2443937 A 5/2008

(Continued)

OTHER PUBLICATIONS

Examination Report for AU 341324, 3 pgs., dated Oct. 24, 2012.

(Continued)

Primary Examiner — Dominic Simone

(74) *Attorney, Agent, or Firm* — Morgan, Lewis & Bockius LLP

(57) **CLAIM**

The ornamental design for a single-sole shoe with purple sole, as shown and described.

DESCRIPTION

The file of this patent contains at least one drawing executed in color. Copies of this patent with color drawing(s) will be provided by the Office upon request and payment of the necessary fee.

FIG. 1 is a perspective view of a single-sole shoe with purple sole showing our new design;
FIG. 2 is a first side view thereof;
FIG. 3 is a second side view thereof;
FIG. 4 is a top view thereof;
FIG. 5 is a bottom view thereof;
FIG. 6 is a front view thereof;
FIG. 7 is a back view thereof;
FIG. 8 is a perspective view of another embodiment of our new design of a single-sole shoe with purple sole, where the purple portions are indicated using the USPTO convention of dashed vertical lines for violet or purple;
FIG. 9 is a first side view thereof;
FIG. 10 is a second side view thereof;
FIG. 11 is a top view thereof;
FIG. 12 is a bottom view thereof;
FIG. 13 is a front view thereof; and,
FIG. 14 is a rear view thereof.

The broken lines illustrating the toe elastic area, the half moon patch, the heel stripe, and the channel on the purple sole in the above described Figures are for illustrative purposes only and form no part of the claimed design.

1 Claim, 12 Drawing Sheets
(5 of 12 Drawing Sheet(s) Filed in Color)

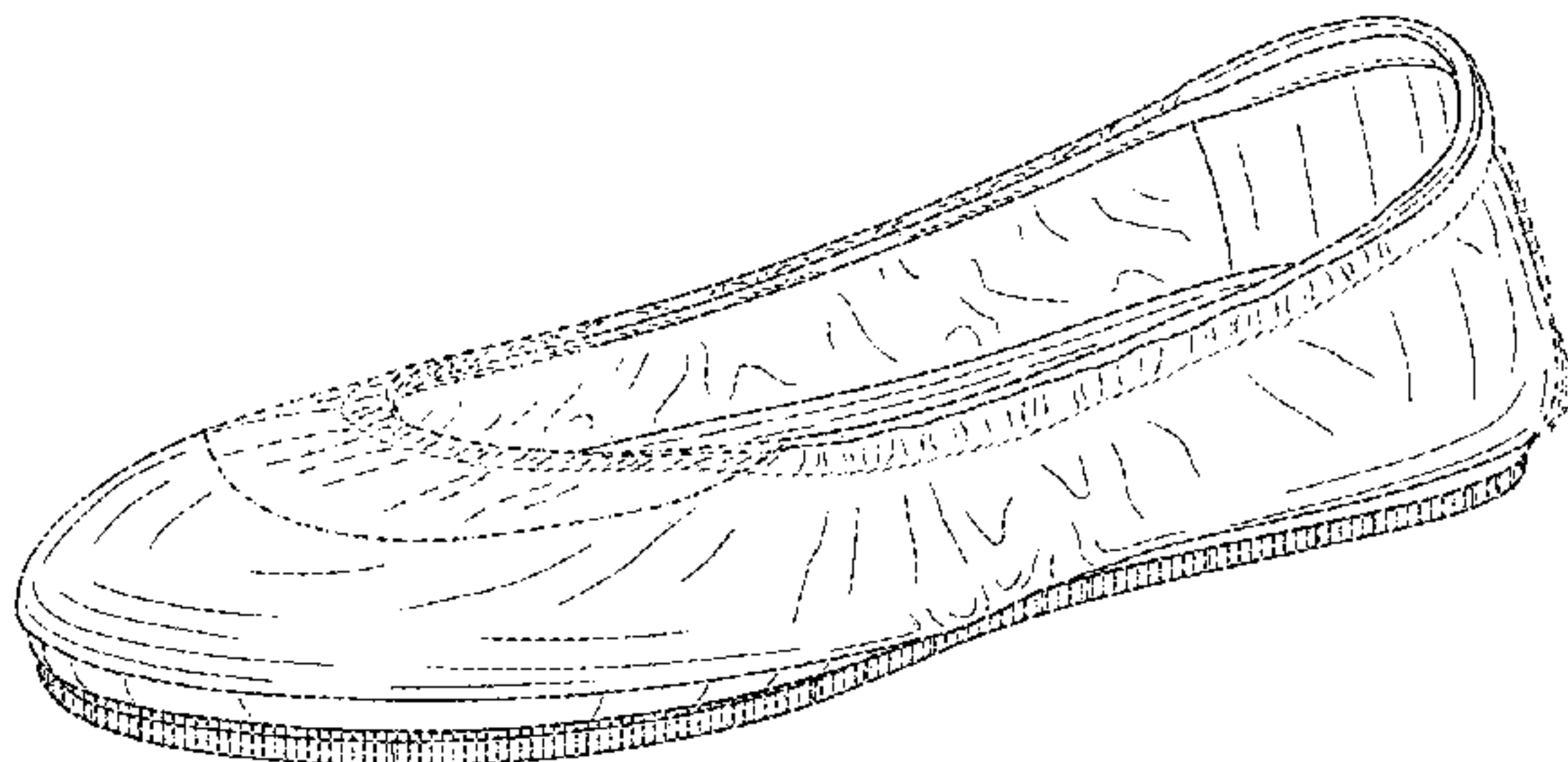
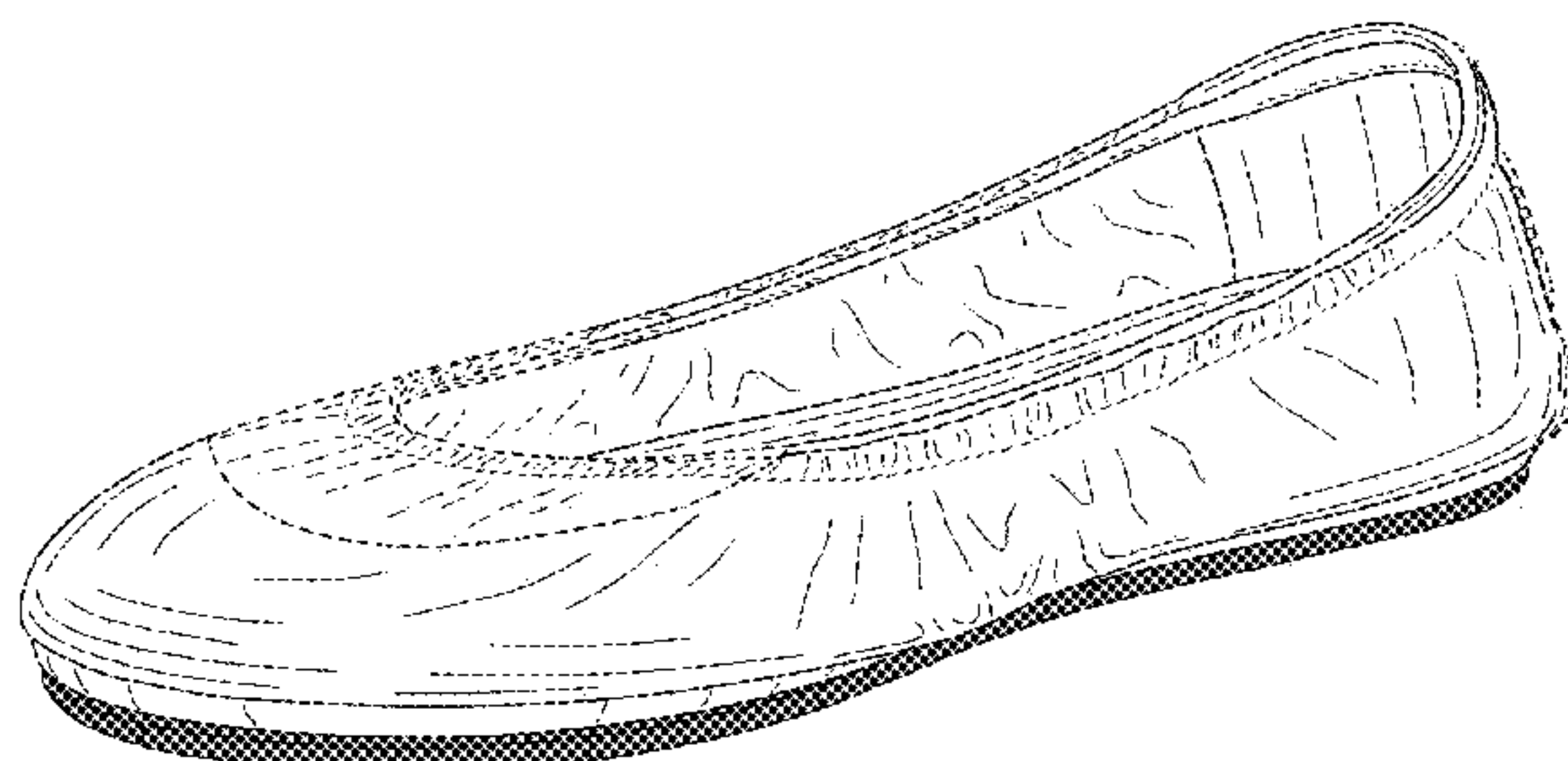

(56)

References Cited

| U.S. PATENT DOCUMENTS | | | | | | | | |
|-----------------------|-----|---------|----------------------|--------------|-----|---------|-------------------|--------|
| 830,941 | A | 9/1906 | Walden | D593,307 | S * | 6/2009 | Belley | D2/969 |
| 1,208,209 | A | 12/1916 | Prince | D599,093 | S * | 9/2009 | Issler | D2/925 |
| 1,214,666 | A | 2/1917 | Ford | D604,030 | S | 11/2009 | Wilson | |
| 1,519,009 | A | 12/1924 | Reina | D607,194 | S | 1/2010 | Zagula | |
| 1,525,848 | A * | 2/1925 | Bonaventure | D610,332 | S | 2/2010 | Raichle | |
| | | | A43B 5/12 | D610,785 | S | 3/2010 | Smith | |
| | | | 36/113 | D612,140 | S | 3/2010 | Moon | |
| 1,587,377 | A | 6/1926 | Grosjean | D612,141 | S | 3/2010 | Moon | |
| 1,650,466 | A | 11/1927 | Righter | 7,694,435 | B1 | 4/2010 | Kiser et al. | |
| 2,224,590 | A | 12/1940 | Boivin | D615,737 | S | 5/2010 | Feller | |
| 2,268,777 | A | 1/1942 | Scholl | 7,735,244 | B1 | 6/2010 | Ameche | |
| D133,819 | S * | 9/1942 | Bonaventure | 7,743,530 | B2 | 6/2010 | Truelsen | |
| D135,791 | S | 6/1943 | Beebe | D618,891 | S | 7/2010 | McClaskie | |
| 2,323,563 | A | 7/1943 | Nugent | 7,757,408 | B2 | 7/2010 | McClaskie | |
| 2,342,882 | A | 2/1944 | Meltzer | D630,829 | S | 1/2011 | Weisner | |
| D141,871 | S | 7/1945 | Braun | D632,881 | S | 2/2011 | Rosenberg | |
| 2,383,585 | A | 8/1945 | Bindner | 7,926,203 | B2 | 4/2011 | Wilkenfeld | |
| D149,685 | S * | 5/1948 | Harris | 7,966,747 | B2 | 6/2011 | Wilkenfeld et al. | |
| D150,729 | S * | 8/1948 | Sandler | D640,861 | S | 7/2011 | Wilkenfeld | |
| D166,090 | S * | 3/1952 | Maling | 8,020,320 | B2 | 9/2011 | Gillespie | |
| 2,772,488 | A | 12/1956 | Meltzer | 8,127,468 | B2 | 3/2012 | Morgan | |
| 2,904,814 | A | 9/1959 | Scholl | D657,543 | S | 4/2012 | Bove | |
| 3,148,378 | A | 9/1964 | Tibbitts | D659,960 | S | 5/2012 | Bizzo | |
| D200,897 | S * | 4/1965 | Mitchell | 8,230,619 | B2 | 7/2012 | Salvatelli | |
| D220,464 | S | 4/1971 | Hayoshi | D664,755 | S | 8/2012 | Gavrieli et al. | |
| D247,396 | S * | 3/1978 | Schlerth | D665,157 | S | 8/2012 | Wu | |
| 4,412,393 | A | 11/1983 | Terlizzi, Jr. et al. | 8,240,067 | B2 | 8/2012 | Sussmann | |
| D275,525 | S | 9/1984 | Nakao | 8,245,420 | B2 | 8/2012 | Wilson | |
| 4,674,206 | A | 6/1987 | Lyden | D668,027 | S | 10/2012 | Millieret | |
| D295,692 | S * | 5/1988 | Zuidema | D668,438 | S | 10/2012 | Millieret | |
| D300,085 | S | 3/1989 | Ito et al. | D668,847 | S * | 10/2012 | Gavrieli | D2/925 |
| RE33,018 | E | 8/1989 | Ostrander | D668,848 | S * | 10/2012 | Gavrieli | D2/925 |
| 4,899,412 | A | 2/1990 | Ganon | D668,849 | S | 10/2012 | Pozzi | |
| D316,773 | S | 5/1991 | Valle | D668,850 | S | 10/2012 | Pozzi | |
| 5,012,541 | A | 5/1991 | Ganon | D672,542 | S | 12/2012 | Gray et al. | |
| D339,669 | S * | 9/1993 | Miller | D676,634 | S * | 2/2013 | Gavrieli | D2/925 |
| 5,282,326 | A | 2/1994 | Schroer, Jr. et al. | D681,927 | S * | 5/2013 | Gavrieli | D2/925 |
| 5,421,050 | A | 6/1995 | Laganas | D681,928 | S * | 5/2013 | Gavrieli | D2/925 |
| 5,699,629 | A | 12/1997 | Munschy | D681,929 | S * | 5/2013 | Gavrieli | D2/925 |
| 5,746,014 | A | 5/1998 | Tanemoto | D683,936 | S * | 6/2013 | Gavrieli | D2/925 |
| D420,785 | S | 2/2000 | Perez | 8,468,723 | B2 | 6/2013 | Malka-Harari | |
| 6,055,745 | A | 5/2000 | Endoh | 8,510,975 | B2 | 8/2013 | Krikelis | |
| 6,076,284 | A | 6/2000 | Terlizzi | D688,853 | S * | 9/2013 | Gavrieli | D2/925 |
| 6,189,239 | B1 | 2/2001 | Gasparovic et al. | D688,854 | S * | 9/2013 | Gavrieli | D2/925 |
| 6,338,207 | B1 | 1/2002 | Chang | D688,855 | S * | 9/2013 | Gavrieli | D2/925 |
| D457,292 | S * | 5/2002 | Sessa | D689,270 | S * | 9/2013 | Gavrieli | D2/925 |
| D461,947 | S | 8/2002 | Merceron | D689,271 | S * | 9/2013 | Gavrieli | D2/925 |
| D476,798 | S | 7/2003 | Reynolds et al. | D689,272 | S * | 9/2013 | Gavrieli | D2/925 |
| 6,588,124 | B2 | 7/2003 | Morrone | D690,914 | S * | 10/2013 | Gavrieli | D2/925 |
| D498,041 | S | 11/2004 | McClaskie | D690,915 | S * | 10/2013 | Gavrieli | D2/925 |
| D500,191 | S * | 12/2004 | Belley | D696,500 | S | 12/2013 | Hunt | |
| D501,706 | S | 2/2005 | McClaskie | D699,424 | S | 2/2014 | Hamm | |
| 6,857,203 | B2 | 2/2005 | Minden | 8,661,714 | B2 | 3/2014 | Sussmann | |
| 6,895,693 | B2 | 5/2005 | Baruck | 8,973,287 | B2 | 3/2015 | Shibata | |
| 6,978,557 | B2 | 12/2005 | Lee | 2002/0078591 | A1 | 6/2002 | Morrone | |
| 7,032,327 | B1 | 4/2006 | Tartaglia et al. | 2002/0129519 | A1 | 9/2002 | Cahan | |
| 7,036,244 | B1 | 5/2006 | Finch | 2003/0070319 | A1 | 4/2003 | Minden | |
| D527,513 | S | 9/2006 | Della Valle | 2003/0121176 | A1 | 7/2003 | Baruck | |
| D529,513 | S * | 10/2006 | Aketa | 2004/0025377 | A1 | 2/2004 | Brannon | |
| D531,790 | S | 11/2006 | Wurzburg | 2005/0022421 | A1 | 2/2005 | Bruckner | |
| D534,341 | S * | 1/2007 | Choi | 2005/0115115 | A1 | 6/2005 | Lacey | |
| D542,513 | S | 5/2007 | Amado et al. | 2005/0217148 | A1 | 10/2005 | Connolly et al. | |
| D556,990 | S | 12/2007 | Cabados | 2005/0262734 | A1 | 12/2005 | Cheng | |
| 7,337,558 | B2 | 3/2008 | Terlizzi et al. | 2006/0086005 | A1 | 4/2006 | Yerian | |
| D567,485 | S | 4/2008 | James | 2006/0156576 | A1 | 7/2006 | Sloan | |
| D570,488 | S | 6/2008 | Kirksey et al. | 2007/0074424 | A1 | 4/2007 | Lin | |
| D571,084 | S | 6/2008 | Comeau | 2007/0204482 | A1 | 9/2007 | Gibson-Collinson | |
| D571,548 | S | 6/2008 | Seamans | 2007/0204483 | A1 | 9/2007 | Kirsch et al. | |
| D571,989 | S | 7/2008 | Siegal | 2008/0052964 | A1 | 3/2008 | Taylor | |
| D580,640 | S | 11/2008 | Wurzburg | 2008/0086912 | A1 | 4/2008 | Wilkenfeld | |
| D582,638 | S | 12/2008 | Ringholz | 2008/0110059 | A1 | 5/2008 | Kuramoto et al. | |
| 7,496,982 | B2 | 3/2009 | Clark et al. | 2009/0019732 | A1 | 1/2009 | Sussmann | |
| 7,506,459 | B2 | 3/2009 | Grisoni et al. | 2009/0193685 | A1 | 8/2009 | Wilson | |
| D591,031 | S | 4/2009 | Cofinco | 2009/0205222 | A1 | 8/2009 | McLinden | |
| D593,295 | S * | 6/2009 | Belley | 2009/0272009 | A1 | 11/2009 | Weisner et al. | |
| D593,297 | S * | 6/2009 | Belley | 2010/0011625 | A1 | 1/2010 | Percival | |
| | | | D2/969 | 2010/0018080 | A1 | 1/2010 | Smith | |
| | | | D2/969 | 2010/0050469 | A1 | 3/2010 | Chen | |
| | | | D2/969 | 2010/0095557 | A1 | 4/2010 | Jarvis | |

(56)

References Cited

U.S. PATENT DOCUMENTS

| | | | |
|--------------|----|---------|------------|
| 2010/0115793 | A1 | 5/2010 | Kraisosky |
| 2010/0122475 | A1 | 5/2010 | Purrington |
| 2010/0146822 | A1 | 6/2010 | MacGregor |
| 2010/0212186 | A1 | 8/2010 | Cheng |
| 2010/0275462 | A1 | 11/2010 | Pucci |
| 2010/0281713 | A1 | 11/2010 | Pantazes |
| 2015/0089843 | A1 | 4/2015 | Gavrieli |

FOREIGN PATENT DOCUMENTS

| | | |
|----|-------------|---------|
| GB | 2 446 205 A | 8/2008 |
| TW | D119165 | 10/2007 |

OTHER PUBLICATIONS

Letter from TMI and Associates with Office Action, 2 pgs, dated Sep. 19, 2012 <http://www.payless.com/store?&TLC=Womens&SLC=WomensNewArrivals>

&BLC=WomensNewArrivalsNewArrivals&With+Regular
&ItemCode=60131&LotNumber=062642&Type=Adult
&Popularity=637&Descriptvein .

Taiwanese Office Action for TW 101300726, 10 pgs., dated Sep. 6, 2012.

“The Love List, Tieks by Gavrieli—Foldable Ballet Flats,” <http://thelovelist-carly.blogspot.com.au/2010/09/tieks-by-gavrieli-foldable-ballet.html>, 3 pgs., Sep. 12, 2010.

“Tieks by Gavrieli,” <http://tieks.com>, 1 pg., retrieved Mar. 13, 2013 from URL.

“Try It Mummy!, Tieks by Gavrieli,” <http://tryitmummy.blogspot.com.au/2010/12/tieks-by-gavrieli.html>, 4 pgs., Dec. 9, 2010.

“Wearability—Real People Style, What came first, the City Flat or the Tieks,” <http://wearability.posterous.com/what-came-first-the-city-flat-or-the-tieks>, 4 pgs., Aug. 29, 2010.

“The Ballet Flat . . . Reinvented; Ballet Flats . . . with a Bonus; Step Into Tieks; Going Places? Take Tieks,” <http://web.archive.org/web/2010052004346/http://www.tieks.com/>; 4 pgs., May 24, 2010.

“Tieks—Comfortable designer flats you can fit in your purse and wear all day, every day,” <http://web.archive.org/web/20110731151555/http://tieks.com/>; 6 pgs., Jul. 31, 2011.

“58th Annual Emmy Awards,” http://spoonsforksandfashion.blogspot.com/2006_08_01_archive.html, depicting Nine West flats, 11 pgs., Aug. 1, 2006.

Pictures of Nine West flats sold in 2006, 3 pgs.

“I Love a Good Ballet Flat!,” <http://dressupfiles.com/i-love-a-good-ballet-flat>, depicting Sue London flats, 4 pgs., Sep. 3, 2010.

Pictures of Sue London flats sold in 2010, 2 pgs.

“Miss Cathie Reviews: The Yosi Samra Foldable Ballet Flat . . .,” <http://www.misscathie.com/2010/01/miss-cathie-reviews-the-yosi-samra-foldable-ballet-flat/>, depicting Yosi Samra flats, 7 pgs., Jan. 2010.

Pictures of Yosi Samra flats sold in 2010, 2 pgs.

“Goodbye two thousand ten,” http://emmajoyrussell.blogspot.com/2010_12_01_archive.html, depicting Gap flats, 39 pgs., Dec. 1, 2010.

Pictures of Gap flats available for sale in 2010, 9 pgs.

“Our newest design of folding flats—Pink,” <https://fitinclouds.wordpress.com/2010/05/16/our-newest-design-of-folding-flats-pink/>, depicting Fit in Clouds flats, 1 pg., May 16, 2010.

“Fit in Clouds Satin Folding Shoes,” <http://www.goodhousekeeping.com/product-reviews/clothing/best-ballet-flats/fit-in-clouds-satin-foldable-ballet-flats>, depicting Fit in Clouds flats, 1 pg., Aug. 2013.

Pictures of Fit in Clouds flats available for sale in 2011, 4 pgs.

“Shoes for Standing,” <https://truthinshoes.wordpress.com/2008/07/>, depicting Sam & Libby flats, 2 pgs., Jul. 31, 2008.

“Target Designer Collaboration: Announcing Sam & Libby Shoes for Target,” <http://www.therecessionista.com/2012/11/target-designer-collaboration-announcing-sam-libby-shoes-for-target.html>, depicting Sam & Libby flats, 1 pg., Nov. 26, 2012.

Pictures of Sam & Libby flats available for purchase in 2011, 5 pgs.

“Save your soles with Citisoles ballet flats,” <http://glamazondiaries.com/2009/07/save-your-soles-with-citisoles-ballet-flats>, depicting Citisoles flats, 3 pgs., Jul. 2009.

Pictures of Citisoles flats available for purchase in 2009, 3 pgs.

“#16 Corso Como Delicious Pumps Review and Giveaway!,” <http://www.mommatoldmeblog.com/2011/01/16-corso-como-delicious-pumps-review.html>, depicting Corso Como flats, 8 pgs., Jan. 16, 2011.

Pictures of Corso Como flats available for sale in 2011, 3 pgs.

“Jil-sander-navy-lead-ballet-flats-product . . .,” www.ebay.com, depicting Jil Sander flats, 4 pgs., Nov. 2013.

Pictures of Jil Sander flats available for sale in 2011, 3 pgs.

“Spare Soles: Shoes That Roll-up & Fold-up,” <http://herpackinglist.com/201101/spare-soles-shoes/>, depicting Spare Soles flats, 2 pgs., Jan. 2011.

Pictures of Spare Soles flats available for sale in 2011, 5 pgs.

The Original Rollable, Foldable ballet flats with matching wristlet—Spare Soles, <http://herpackinglist.com/2011/01/spare-soles-shoes/>, depicting Roll-Upz Spare Soles flats, 2 pgs., Jan. 2011.

Pictures of Roll-Upz by Spare Soles flats available for sale in 2011, 6 pgs.

“The Cutest Blog, Preppy 50 and Loving Lilly, Ballet Flat Delight,” <http://preppy50andlovinglilly.blogspot.com/2011/02/ballet-flat-delight.html>, depicting Henri Bendel flats, 13 pgs., Feb. 19, 2011.

Pictures of Henri Bendel flats available for sale in 2011, 4 pgs.

“Mumsnet by parents for parents,” http://www.mumsnet.com/Talk/style_and_beauty/a1612000-Anyone-tried-Redfoot-Flatmates-foldable-ballet-pumps, depicting Redfoot Flatmates flats, 1 pg, Nov. 14, 2012.

Pictures of Redfoot Flatmates flats available for sale in 2011, 6 pgs.

“Amazon.com: Customer Reviews: Bloch London Women’s Lux Ballet Flat,” <http://www.amazon.com/Bloch-London-Womens-Ballet-Flat/product-reviews/B004LWP7YW>, depicting Bloch London flats, 4 pgs., Dec. 11, 2011.

Pictures of Bloch London flats offered for sale in 2011, 11 pgs.

“h&m foldable leopard print flat,” <http://845shops.wordpress.com/2011/06/16/flats-for-7-bucks/shoe1/>, depicting h&m flats, 3 pgs., Jun. 16, 2011.

Pictures of h&m foldable flats offered for sale in 2011, 4 pgs.

“Seekyt—Juicy Couture Ballet Flats—Are They Worth the Money?,” <http://seekyt.com/juicy-couture-ballet-flats-are-they-worth-the-money/>, 14 pgs., Jun. 3, 2011.

Pictures of Juicy Couture flats offered for sale in 2011, 3 pgs.

“Purse Flats,” <http://purseflats.wordpress.com>, depicting Purse Flats by Erica Wilson, 3 pgs., Jul. 12, 2012.

Pictures of Purse Flats by Erica Wilson offered for sale in 2011, 6 pgs.

“Splash Page,” <http://web.archive.org/web/20100524004346/http://www.tieks.com/>, 4 pgs., May 24, 2010.

“Tieks—Comfortable, designer flats you can fit in your purse and wear all day, every day,” <http://web.archive.org/web/20110731151555/http://tieks.com/>, 6 pgs., Jul. 31, 2011.

“Tieks by Gavrieli—Comfortable, designer flats you can fit in your purse and wear all day . . .,” <http://web.archive.org/web/20110202210649/http://www.tieks.com/>, 8 pgs., Feb. 2, 2011.

“Carolina M. M. Gonzalez > Tieks by Gavrieli,” http://m2.facebook.com/Tieks?v=timeline&filter=2&timecutoff=1406427986&page=17§ionLoadingID=m_timeline_loading_div_1293868799_1262332800_8_17&timeend=1293868799×tart=1262332800&tm=AQDOvqhWQPN_Nbwm&refid=17, 1 pg. Jan 26, 2010.

“The Shoes Oprah Would Wear to Work (if She Had to Walk),” <http://www.inc.com/30under30/christina-desmarais/kfir-gavrieli-and-elram-gavrieli-founders-of-tieks.html>, 8 pgs., Jul. 2, 2012.

“Tieks by Gavrieli,” http://m2.facebook.com/Tieks?v=timeline&filter=2&timecutoff=1406427986&page=14§ionLoadingID=m_timeline_loading_div_1293868799_1262332800_8_14&timeend=1293868799×tart=1262332800&tm=AQDOvqhWQPN_Nbwm&refid=17, 4 pgs., Jan. 26, 2010.

“Mighty Life List, Sensible Shoes,” <http://mightygirl.com/2010/08/24/sensible-shoes/>, 10 pgs., Aug. 24, 2010.

“Find! Tieks: Fab & sexy flats for fall,” <http://thefabmom.com/2013/08/29/find-tieks-fab-sexy-flats-for-fall/>, 3 pgs. Aug. 29, 2013.

(56)

References Cited

OTHER PUBLICATIONS

“Step into Ticks,” <http://sliceofpink.typepad.com/blog/2010/09/ticks-1.html>, 5 pgs., Sep. 22, 2010.

“In Need of Flat-Soled Shoes,” <http://sliceofpink.typepad.com/blog/2010/09/ticks-1.html>, 7 pgs., Oct. 3, 2010.

* cited by examiner

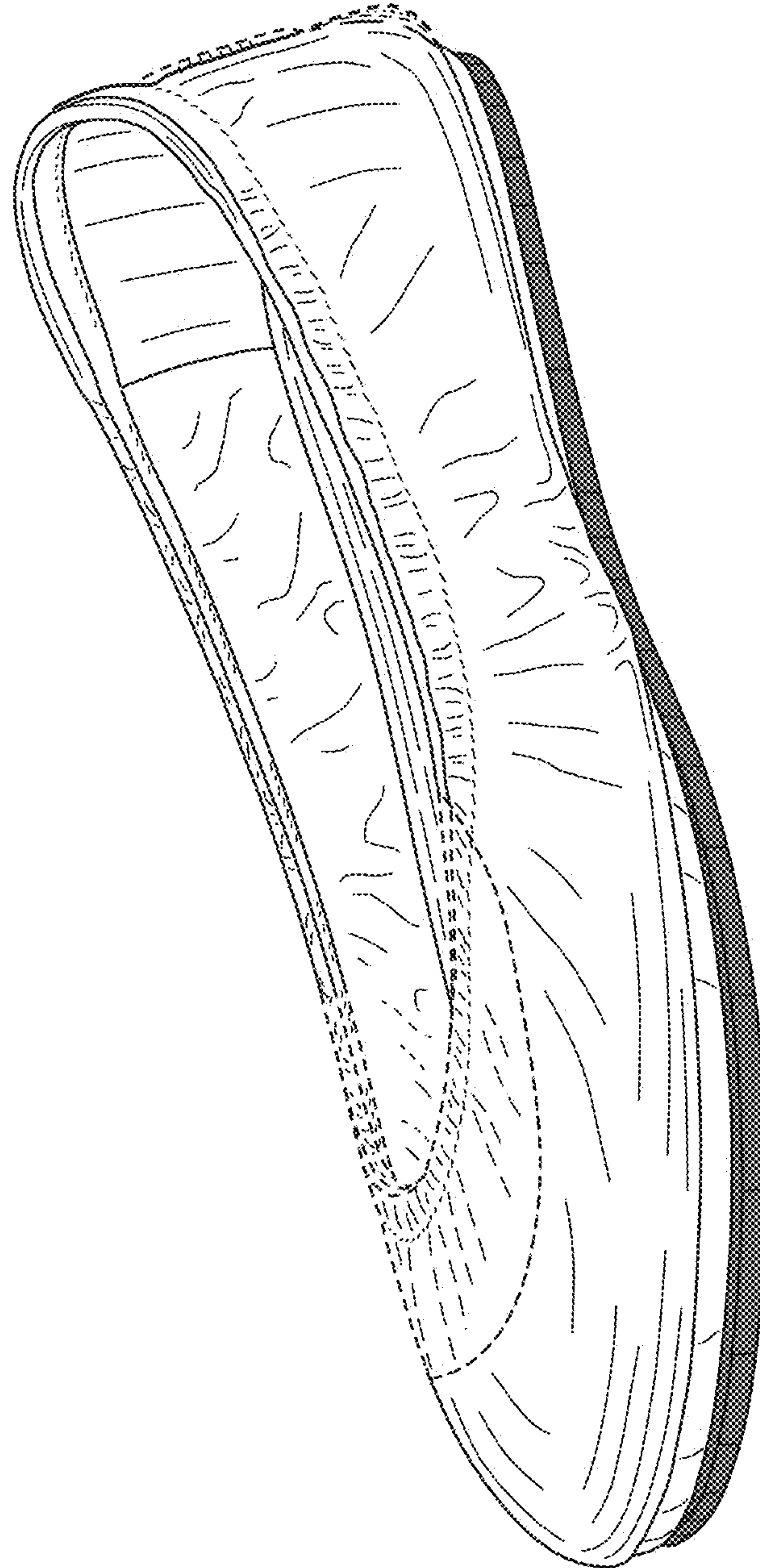

FIG. 1

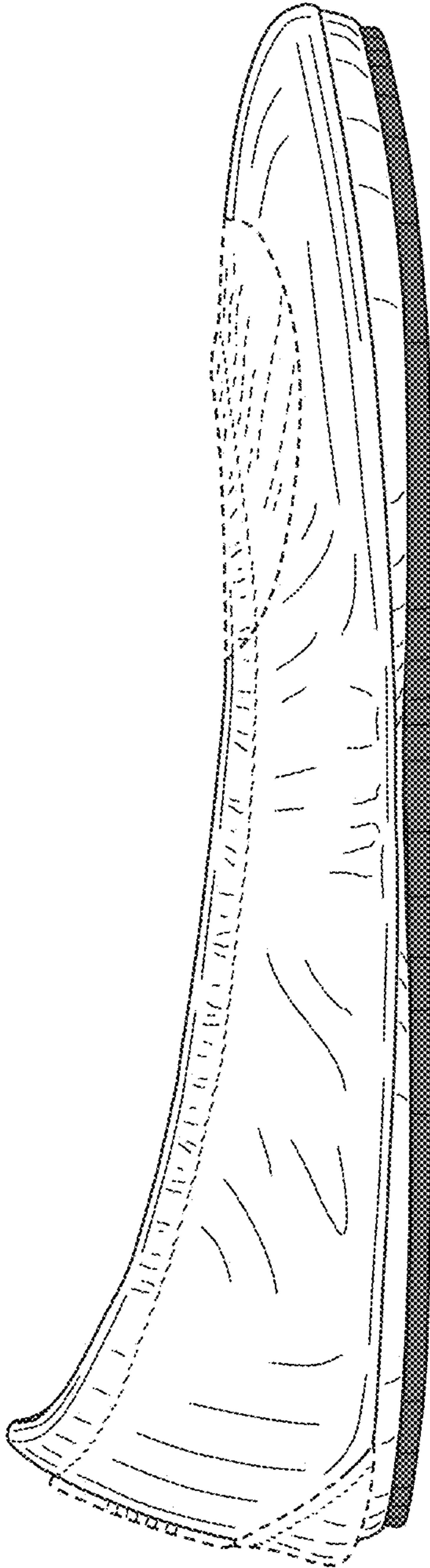

FIG. 2

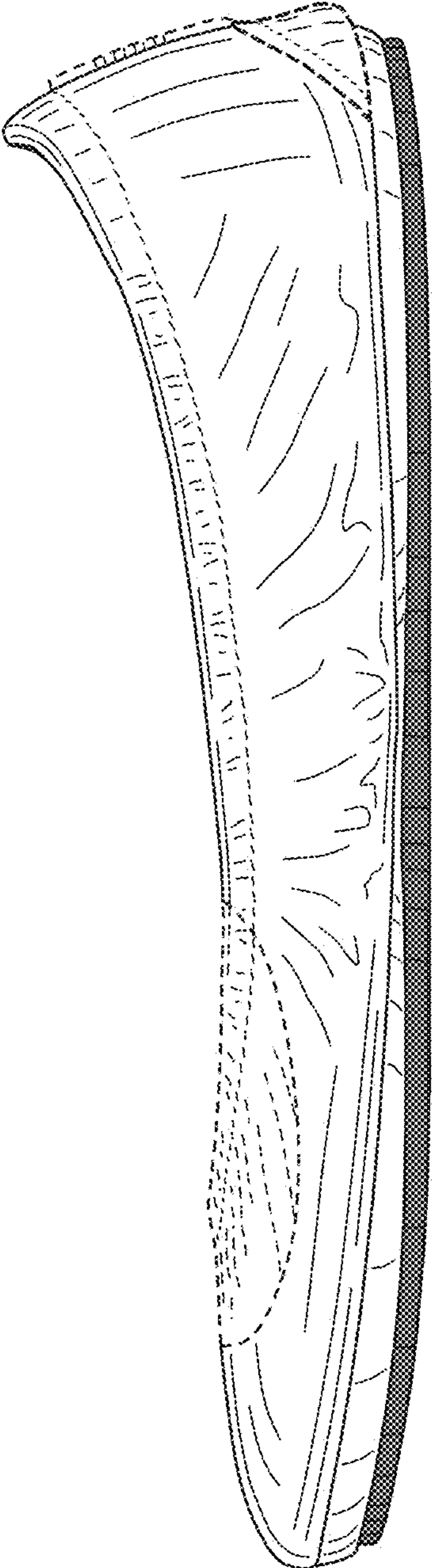

FIG. 3

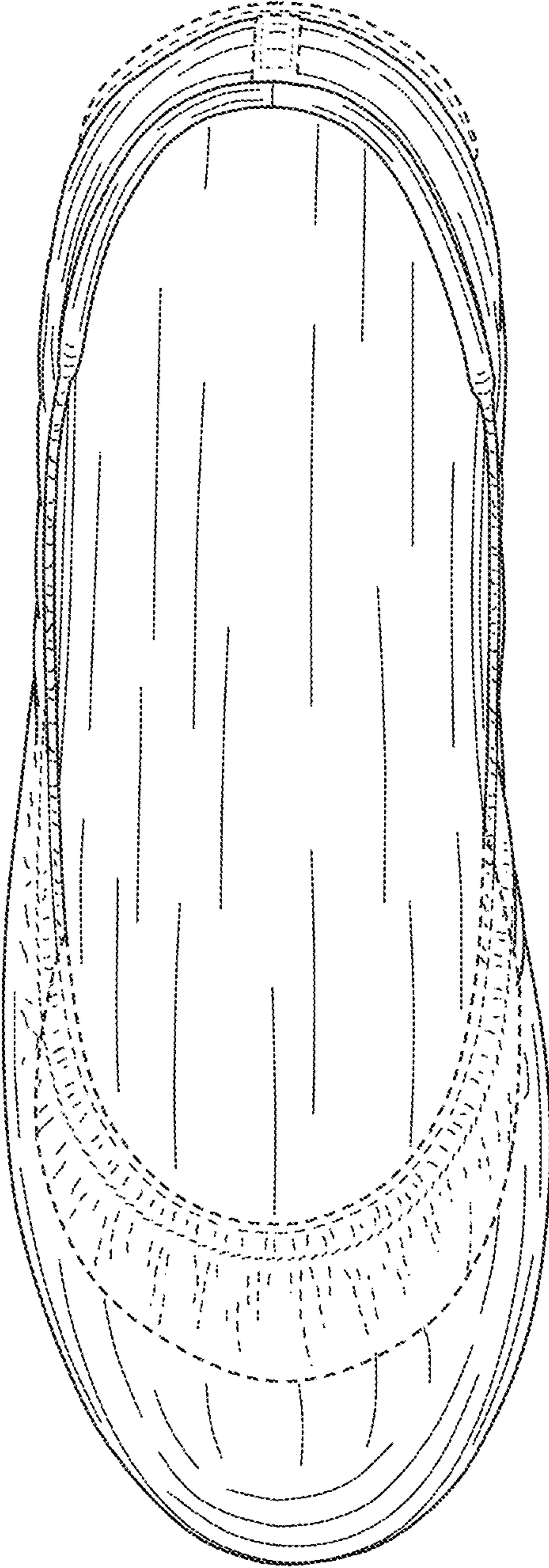

FIG. 4

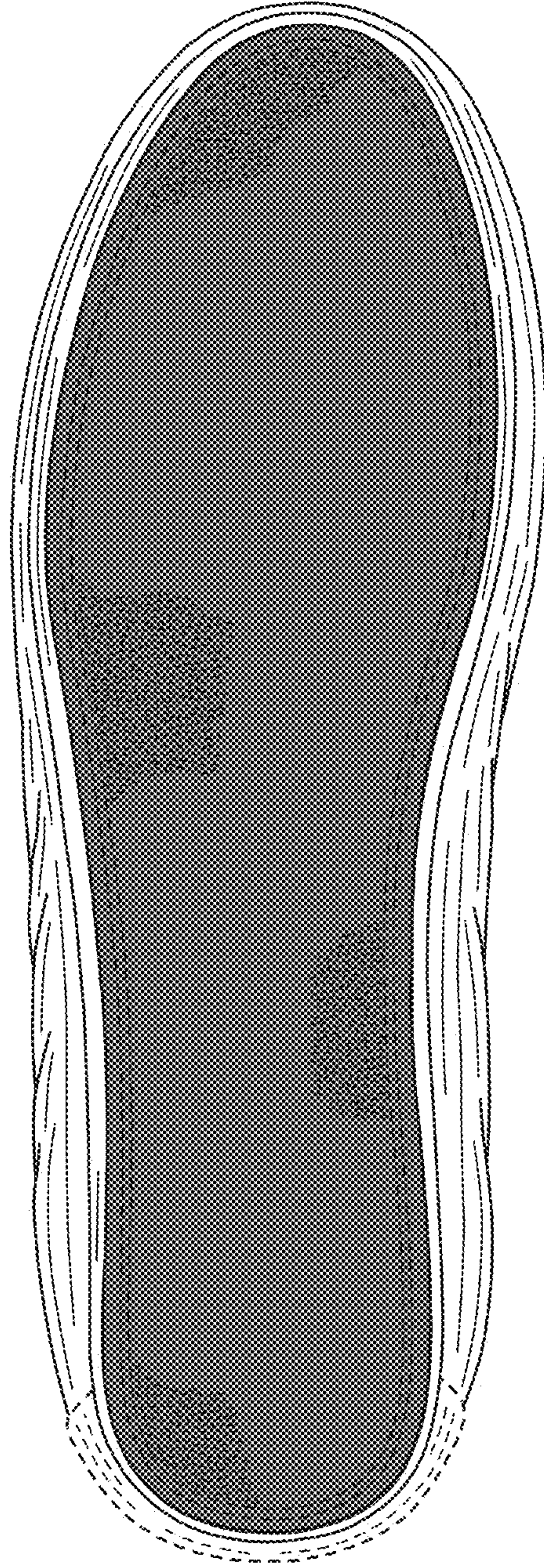

FIG. 5

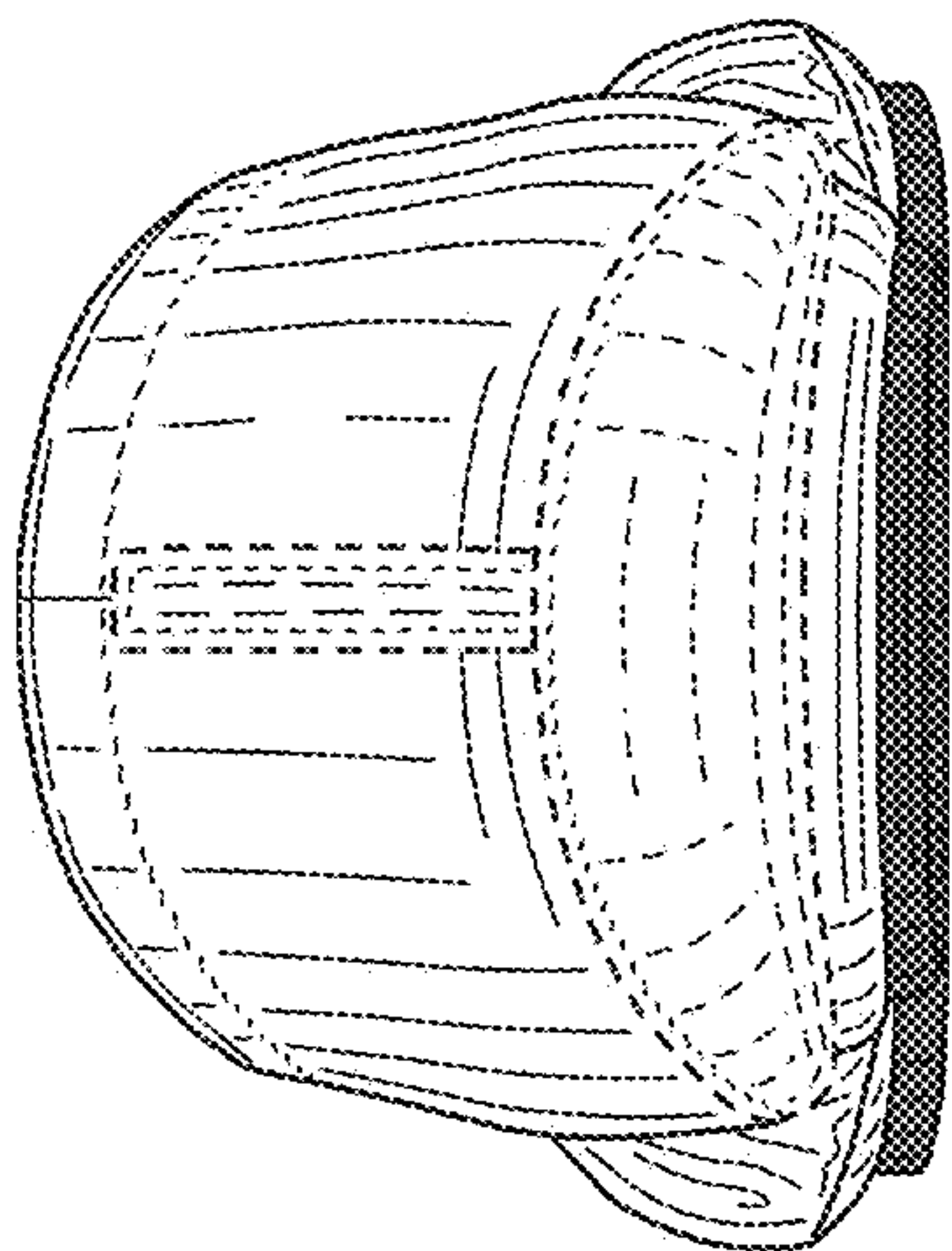

FIG. 6

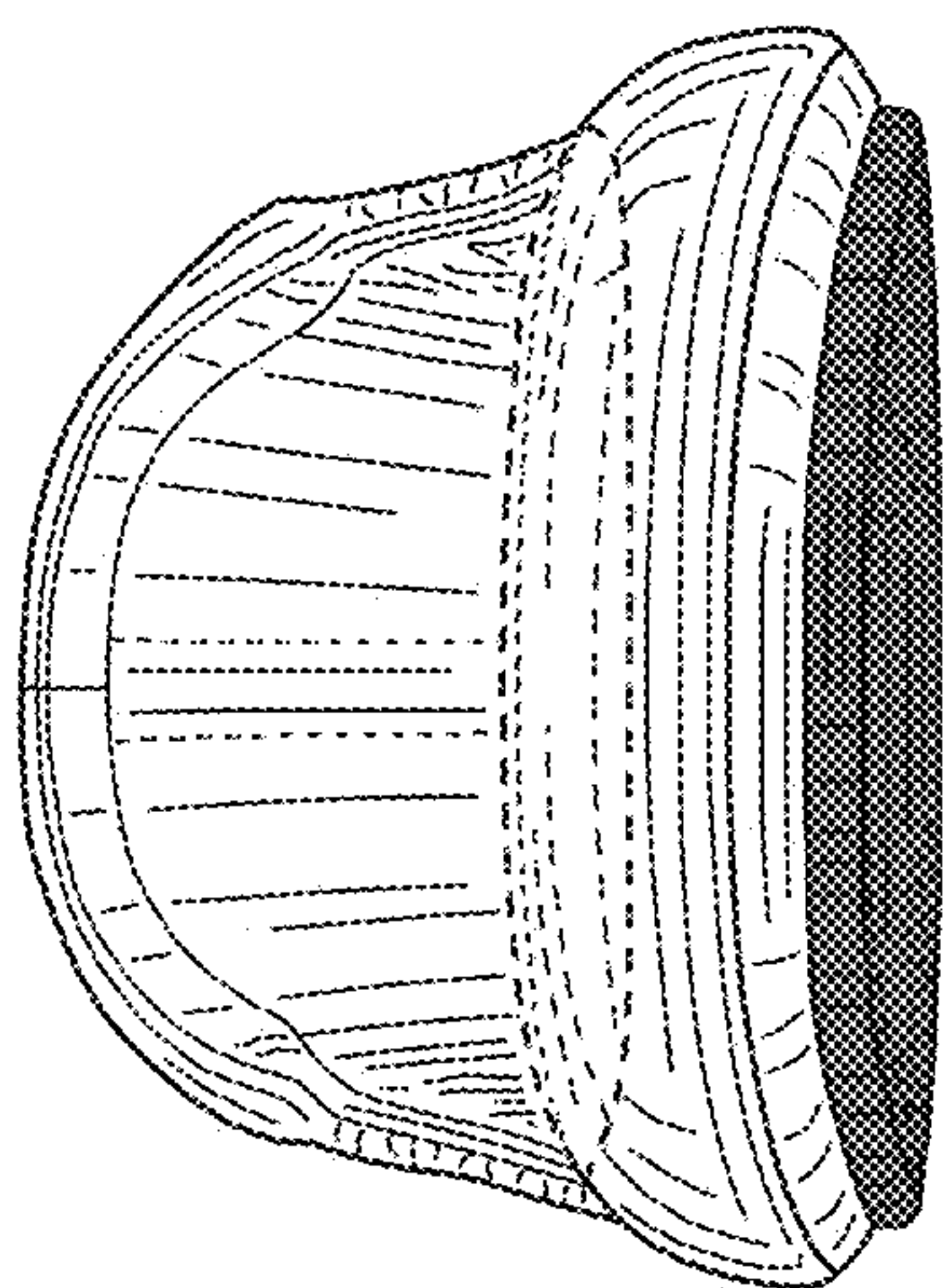

FIG. 7

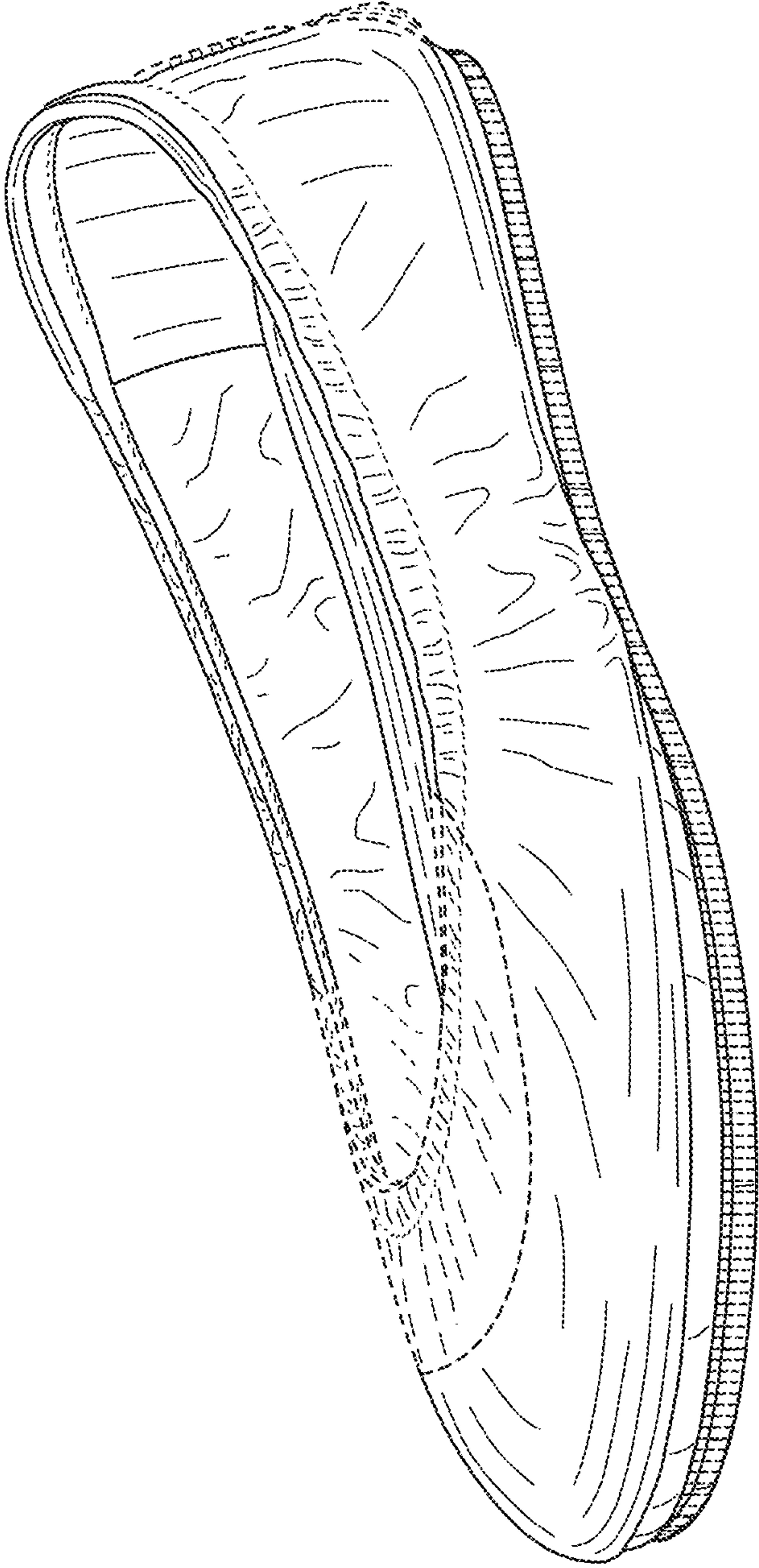

FIG. 8

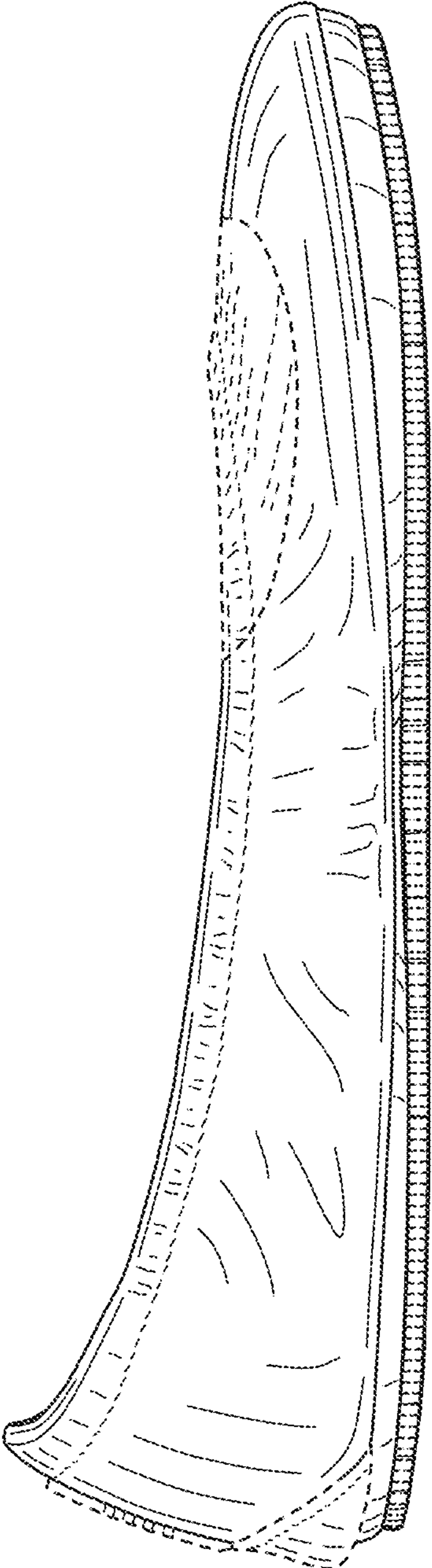

FIG. 9

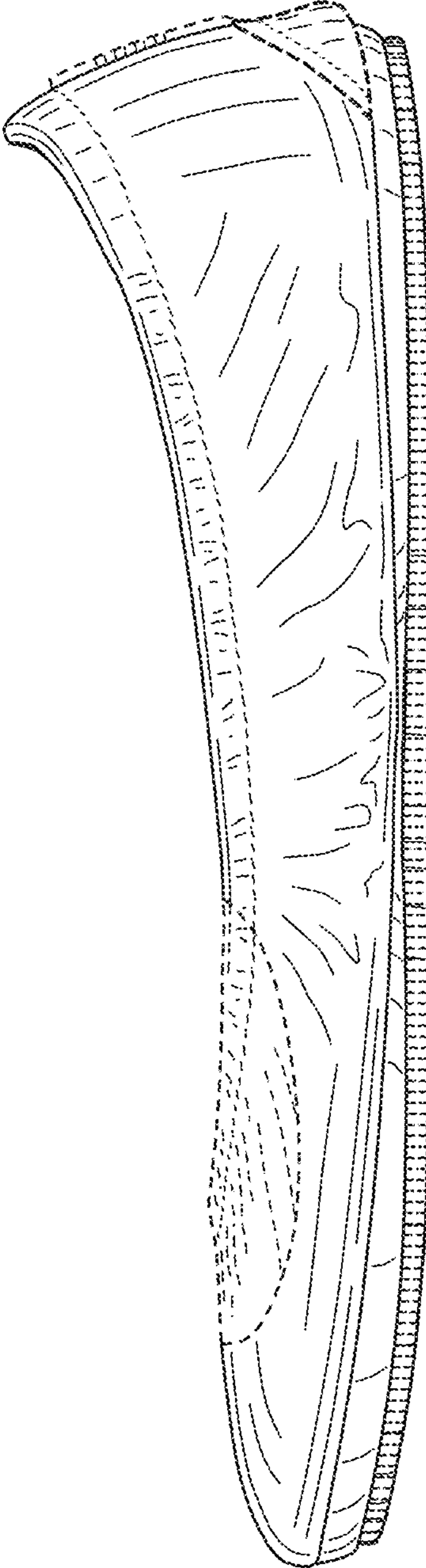

FIG. 10

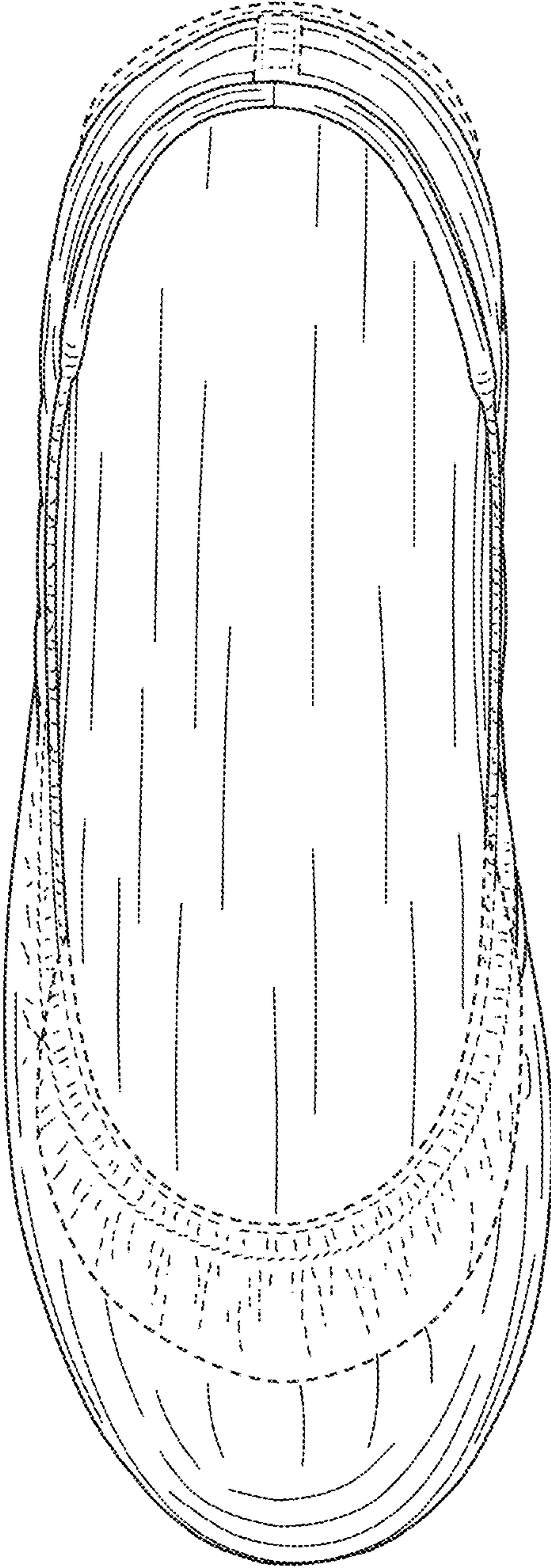

FIG. 11

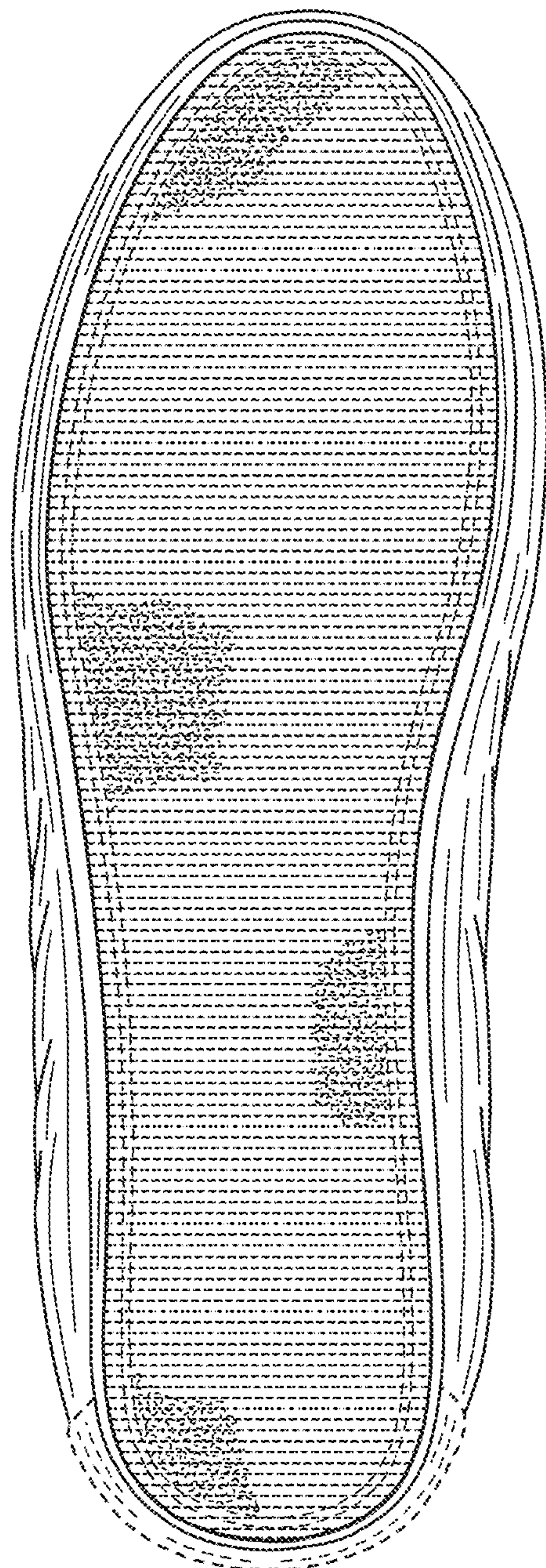

FIG. 12

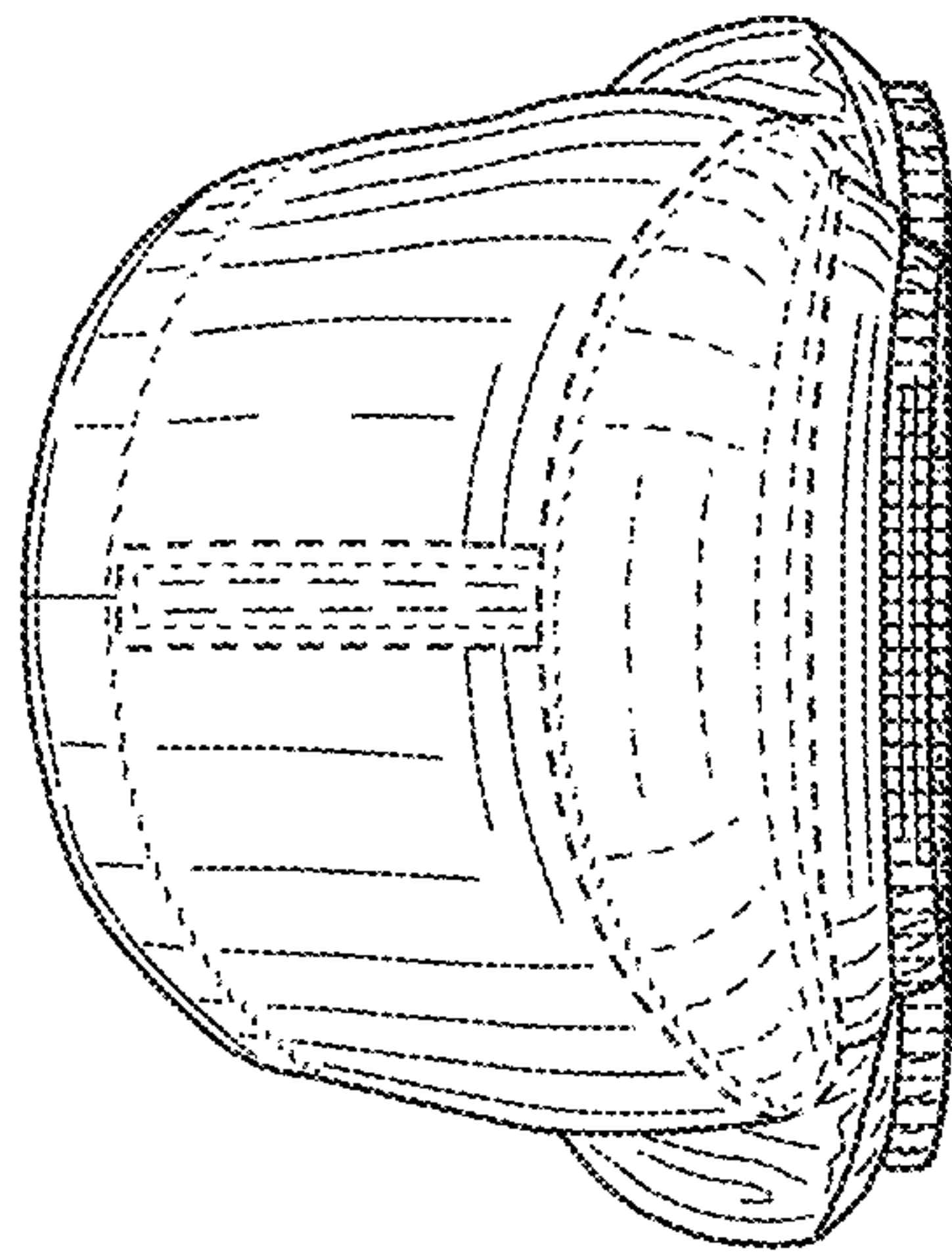

FIG. 13

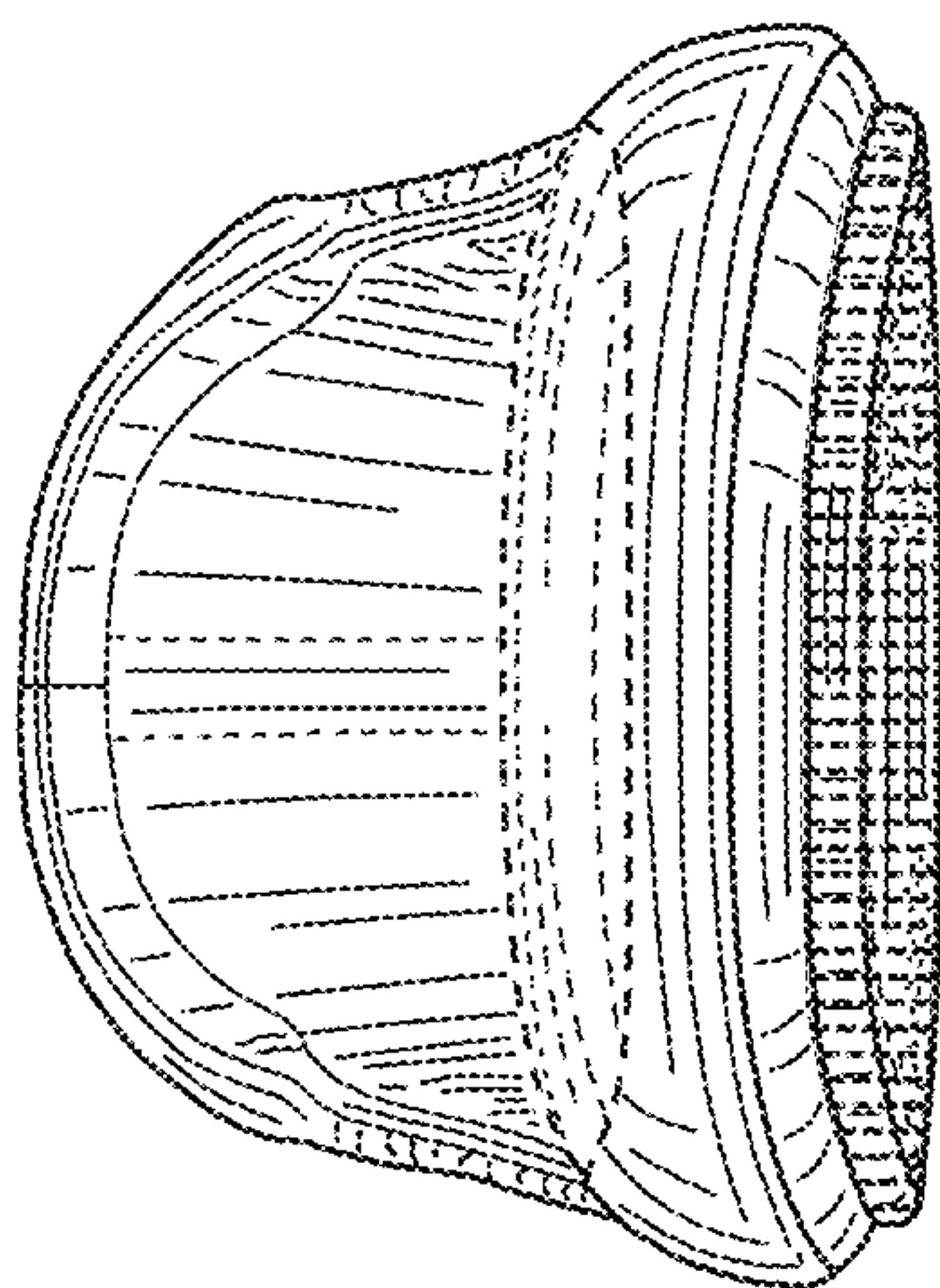

FIG. 14