



US00D763512S

(12) **United States Design Patent**
Teller et al.

(10) **Patent No.:** **US D763,512 S**
(45) **Date of Patent:** **** *Aug. 9, 2016**

(54) **TRANSLUCENT COSMETIC PRODUCT CONTAINER**

(71) Applicant: **EOS PRODUCTS, LLC**, New York, NY (US)

(72) Inventors: **Jonathan Teller**, New York, NY (US);
Sanjiv Mehra, New York, NY (US);
Peter Waxman, New York, NY (US);
Joseph Speter, New York, NY (US);
Sherry Jhawar, New York, NY (US);
Hamish Campbell, New York, NY (US)

(73) Assignee: **EOS PRODUCTS, LLC**, New York, NY (US)

(*) Notice: This patent is subject to a terminal disclaimer.

(**) Term: **14 Years**

(21) Appl. No.: **29/479,121**

(22) Filed: **Jan. 13, 2014**

(51) **LOC (10) Cl.** **28-03**

(52) **U.S. Cl.**
USPC **D28/82**; D28/88; D9/519; D9/552;
D9/554

(58) **Field of Classification Search**

USPC D28/85-91, 82, 76-79, 4-7, 8.1, 8.2, 9;
D9/502, 570, 503, 504, 519, 552, 554,
D9/557, 564, 566, 567, 600, 726, 601, 551,
D9/521, 416, 529, 438, 435; D24/101,
D24/102; D1/127, 130; D5/43, 44, 56, 59,
D5/60, 62, 55; 132/316, 317, 318, 320;
206/581, 823, 385; D3/265, 270,
D3/271.1; 424/467; D14/489
CPC B65D 1/00; B65D 3/00; B65D 5/00;
B65D 11/00; B65D 25/00; B65D 81/00
See application file for complete search history.

(56) **References Cited**

U.S. PATENT DOCUMENTS

1,852,455 A	4/1932	Friedman	
2,745,642 A *	5/1956	Hermann	366/130
3,167,079 A *	1/1965	Weil	134/137
3,292,840 A *	12/1966	Schmidt	220/4.25
3,494,515 A *	2/1970	Fattori	222/548
4,765,501 A *	8/1988	Kao	220/4.21

(Continued)

FOREIGN PATENT DOCUMENTS

JP	1136041 S	3/2002
JP	2001321140 A	11/2004

OTHER PUBLICATIONS

SIPO Office Action issued Jul. 17, 2014 in connection with CN Appl. No. 201080063211.X citing JP 2004-321410A and JP 1136041S (listed separately).

Primary Examiner — Marianne Pandozzi

Assistant Examiner — Jae Liang

(74) *Attorney, Agent, or Firm* — Martin & Ferraro, LLP

(57) **CLAIM**

The ornamental design for a translucent cosmetic product container, as shown and described.

DESCRIPTION

FIG. 1 is a front elevational view of a translucent cosmetic product container showing my new design; FIG. 2 is a right side elevational view thereof; FIG. 3 is a left side elevational view thereof; FIG. 4 is a rear elevational view thereof; FIG. 5 is a top plan view thereof; and, FIG. 6 is a bottom plan view thereof.

The broken lines in the drawing depict portions of the translucent cosmetic product container that form no part of the claimed design.

The stippling in FIGS. 1-6 shows contrast in appearance.

1 Claim, 3 Drawing Sheets

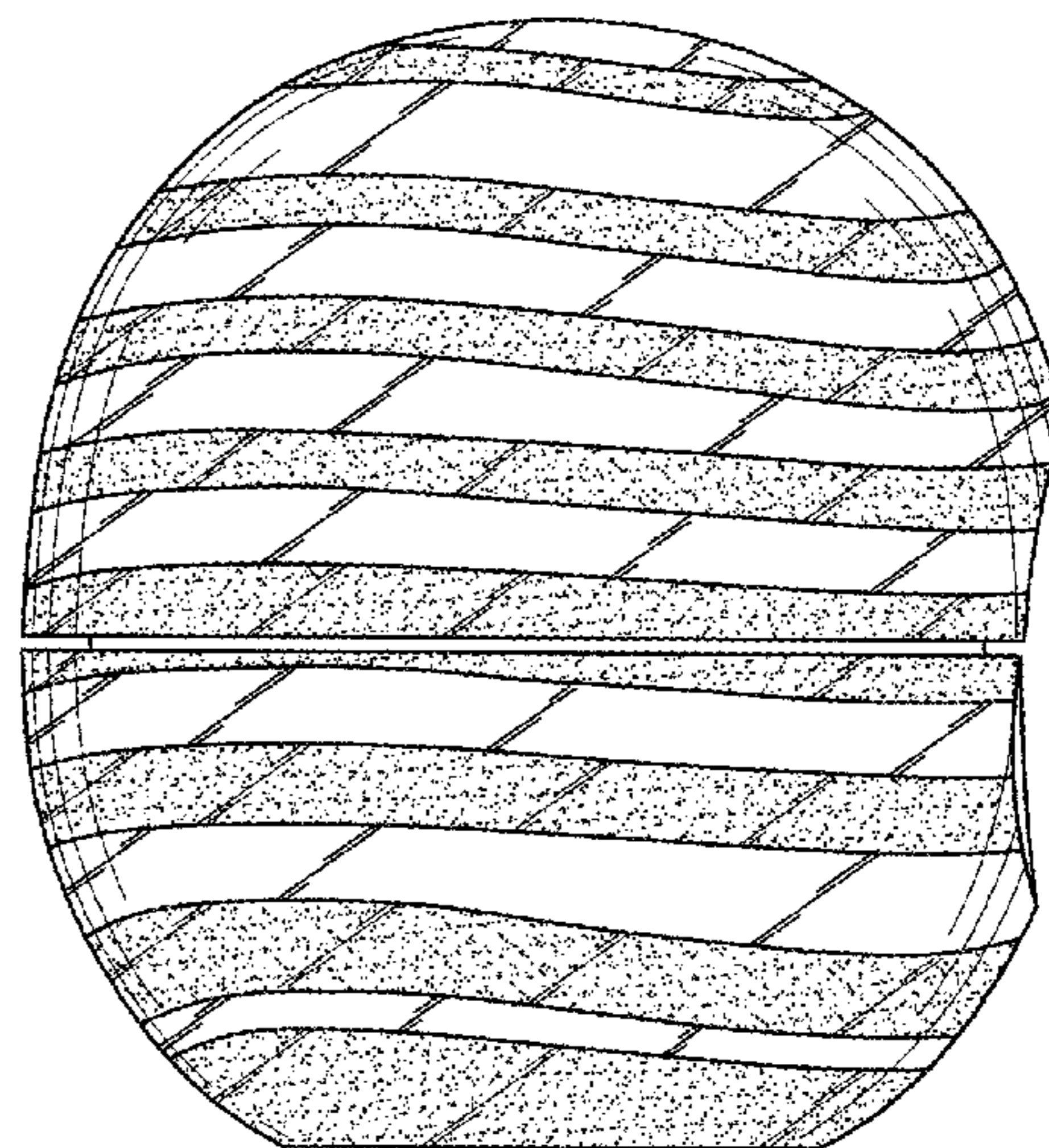
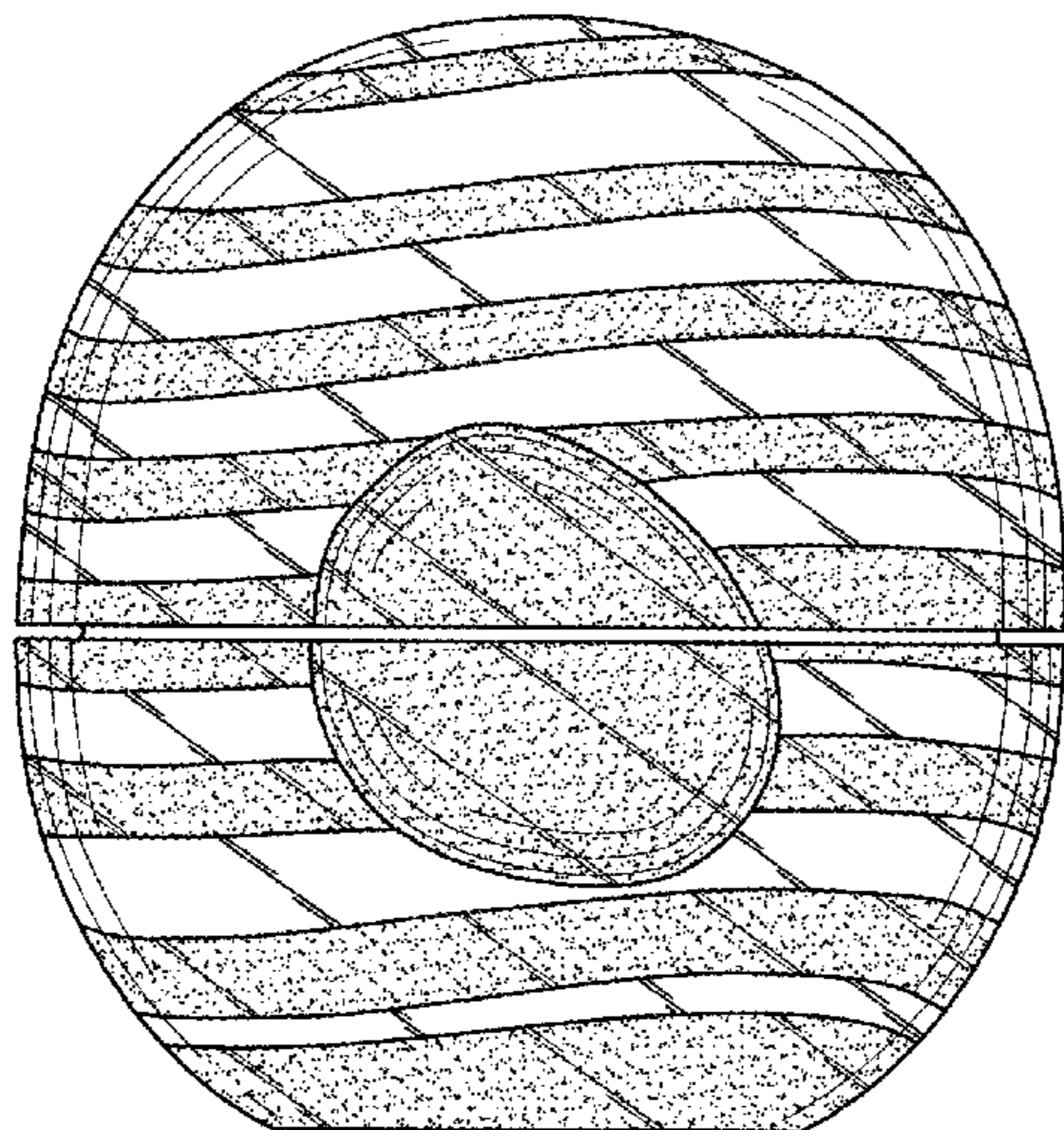

(56)

References Cited

U.S. PATENT DOCUMENTS

5,044,496	A	9/1991	Tanaka				
D322,558	S *	12/1991	Halm et al.	D32/29.1		
D378,275	S *	3/1997	Rusnock et al.	D9/545		
D396,382	S *	7/1998	Hsu	D7/599		
D403,123	S *	12/1998	Sgariboldi	D28/76		
6,193,427	B1	2/2001	Benguigui				
D443,826	S *	6/2001	Gnann et al.	D9/537		
D450,882	S *	11/2001	Colwell et al.	D28/4		
D452,586	S *	12/2001	Look	D28/4		
D452,588	S *	12/2001	Look	D28/4		
6,394,972	B1	5/2002	Slishman				
D465,609	S *	11/2002	Jackel-Marken	D28/4		
D465,733	S *	11/2002	Hill	D9/519		
D472,014	S *	3/2003	Jackel-Marken	D28/4		
D512,199	S *	12/2005	Ibanez	D1/129		
D516,431	S *	3/2006	Vintro	D9/521		
D525,437	S *	7/2006	Leisch et al.	D5/53		
D537,563	S *	2/2007	Taniguchi et al.	D28/4		
D541,052	S *	4/2007	Miller et al.	D5/53		
D552,997	S *	10/2007	Blasko	D9/521		
D554,529	S *	11/2007	Green et al.	D9/726		
D564,900	S *	3/2008	Green et al.	D9/715		
D570,219	S *	6/2008	Blasko	D9/516		
D579,213	S *	10/2008	Aipa	D5/53		
D592,064	S *	5/2009	Kilany	D9/519		
D592,512	S *	5/2009	Dubitsky et al.	D9/516		
D599,560	S *	9/2009	Sharma	D5/59		
D609,107	S *	2/2010	Dubitsky et al.	D9/551		
D612,245	S *	3/2010	Canamasas Puigbo	D9/519		
D625,469	S *	10/2010	Dubitsky et al.	D28/84		
D631,204	S *	1/2011	Dubitsky et al.	D28/82		
D644,939	S *	9/2011	Teller	D9/726		
8,444,337	B2 *	5/2013	Teller	401/88		
D688,000	S *	8/2013	Johnson et al.	D28/4		
D689,366	S *	9/2013	Kohne et al.	D9/504		
D695,552	S *	12/2013	Gatto	D6/606		
D705,988	S *	5/2014	Scott et al.	D28/7		
D708,726	S *	7/2014	Gordon et al.	D23/356		
D710,544	S *	8/2014	Shen	D28/77		
D715,142	S *	10/2014	Allen et al.	D9/434		
D726,028	S *	4/2015	Thompson	D9/726		

* cited by examiner

FIG. 1

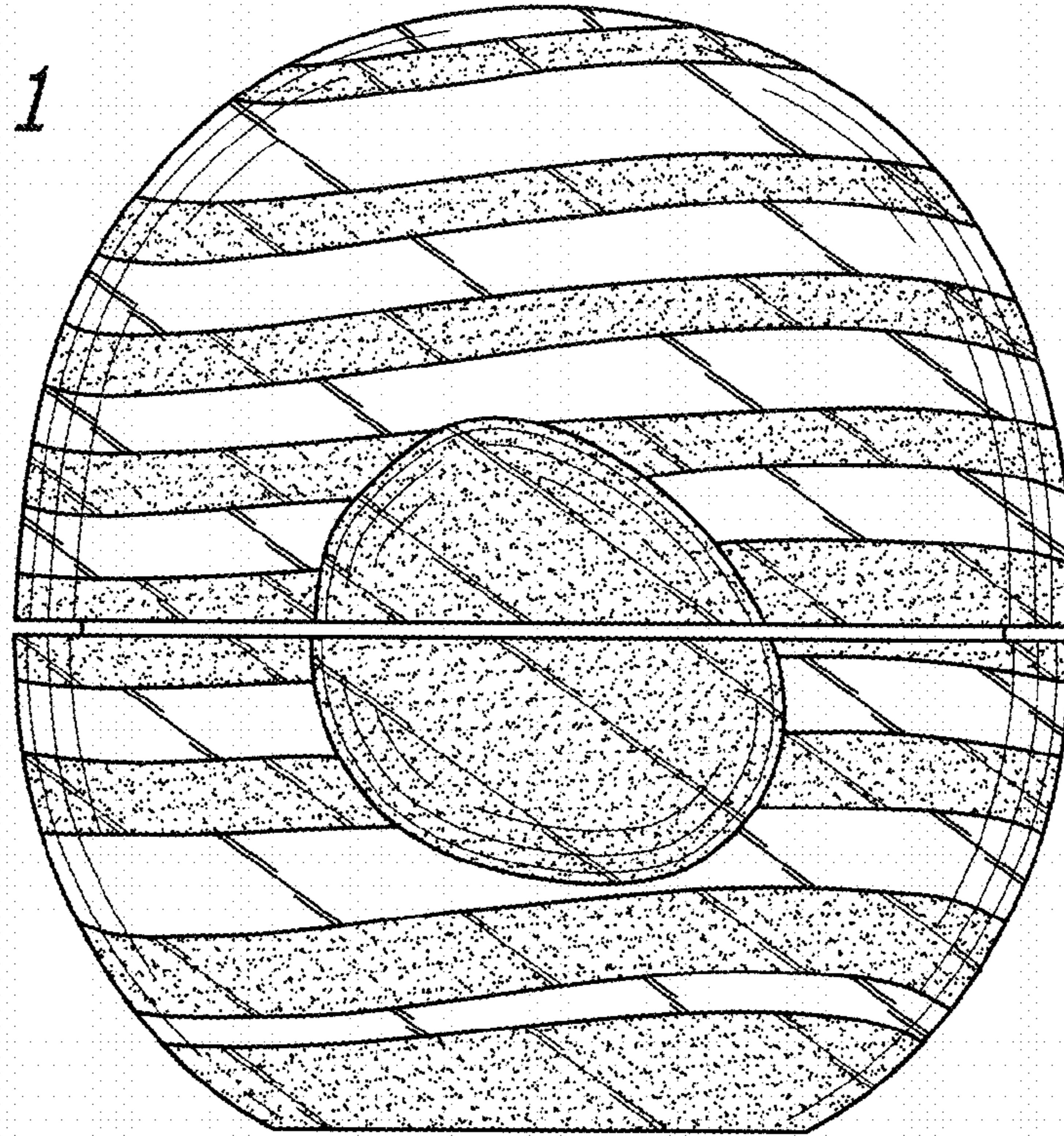

FIG. 2

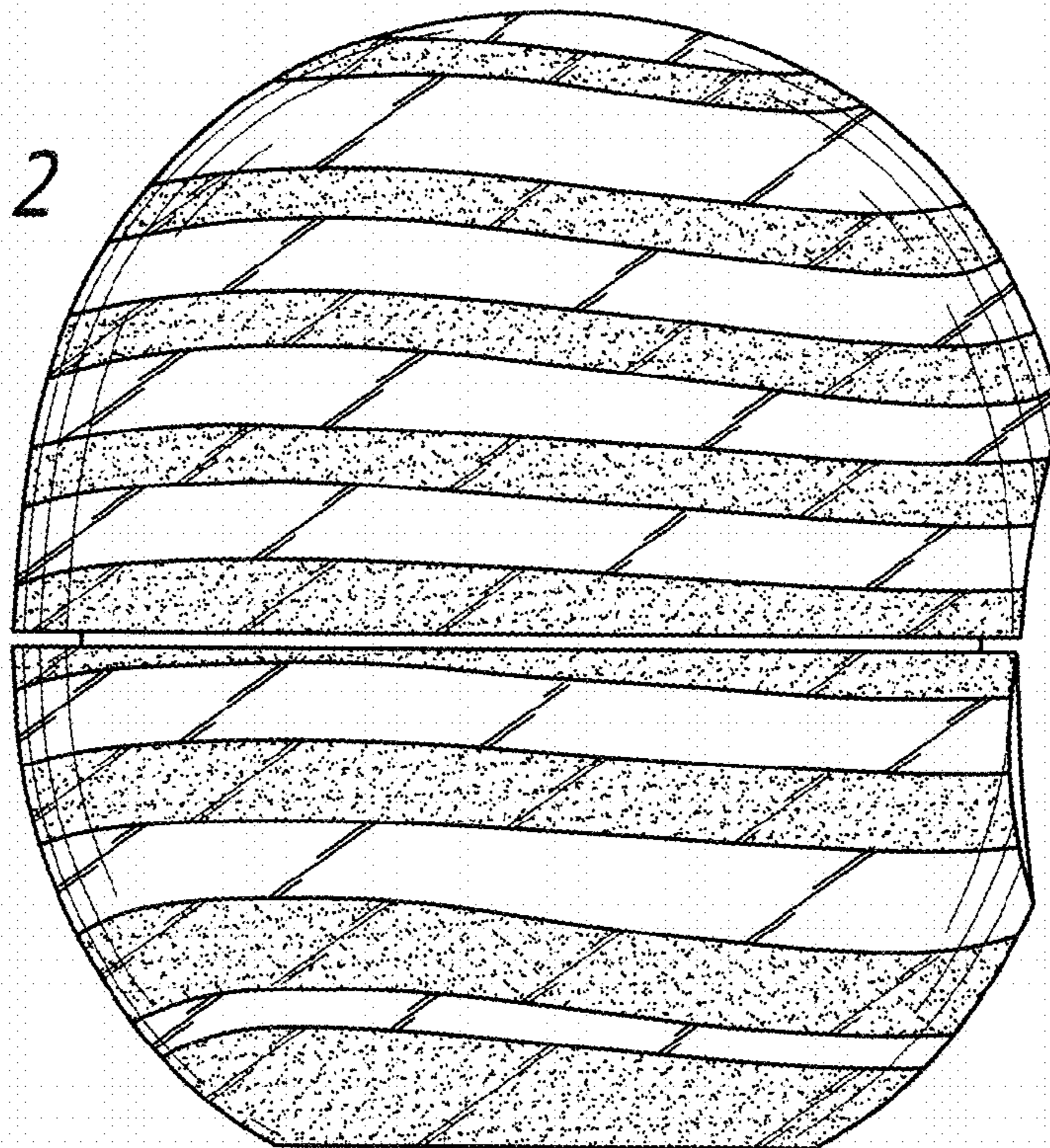

FIG. 3

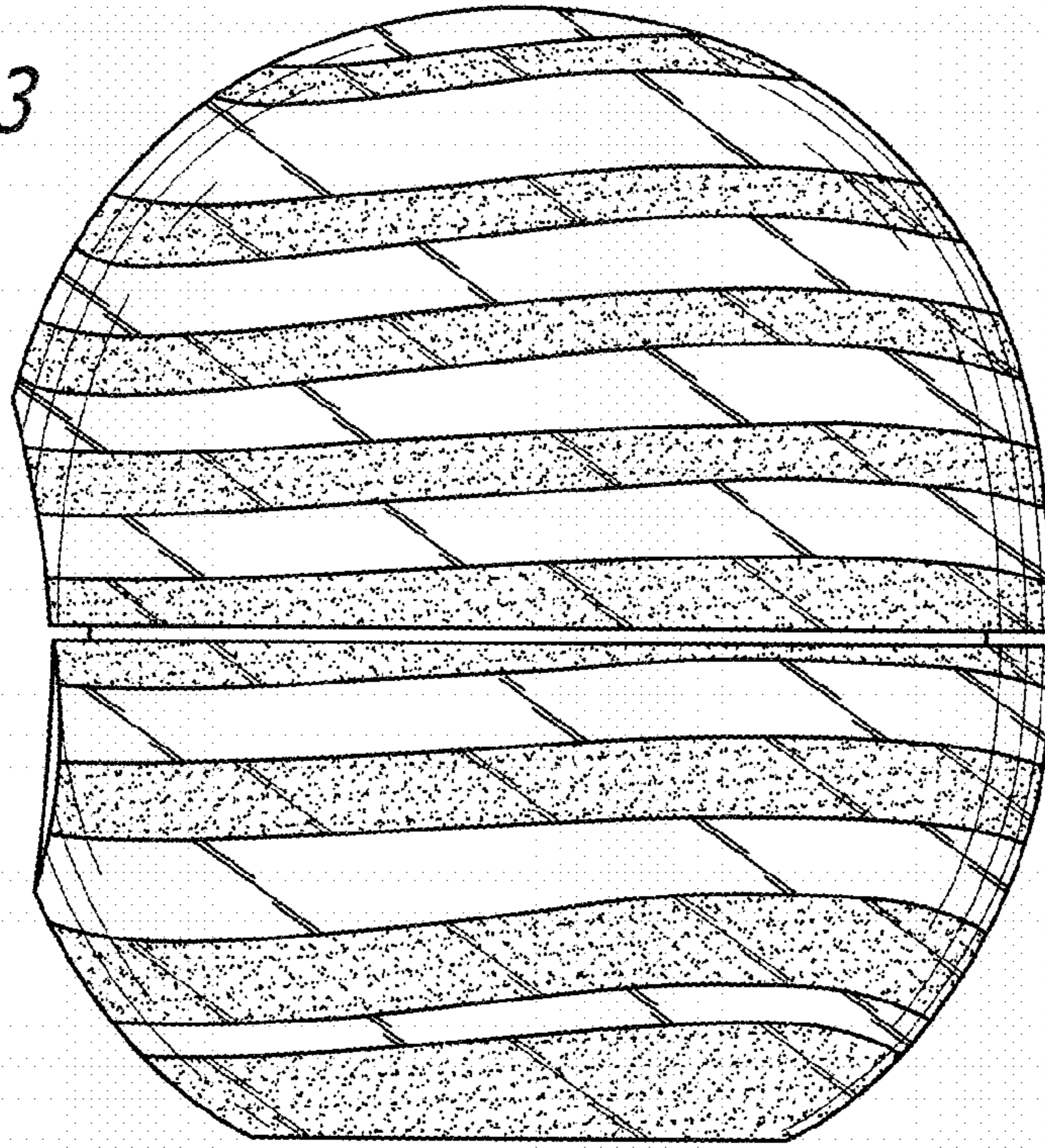

FIG. 4

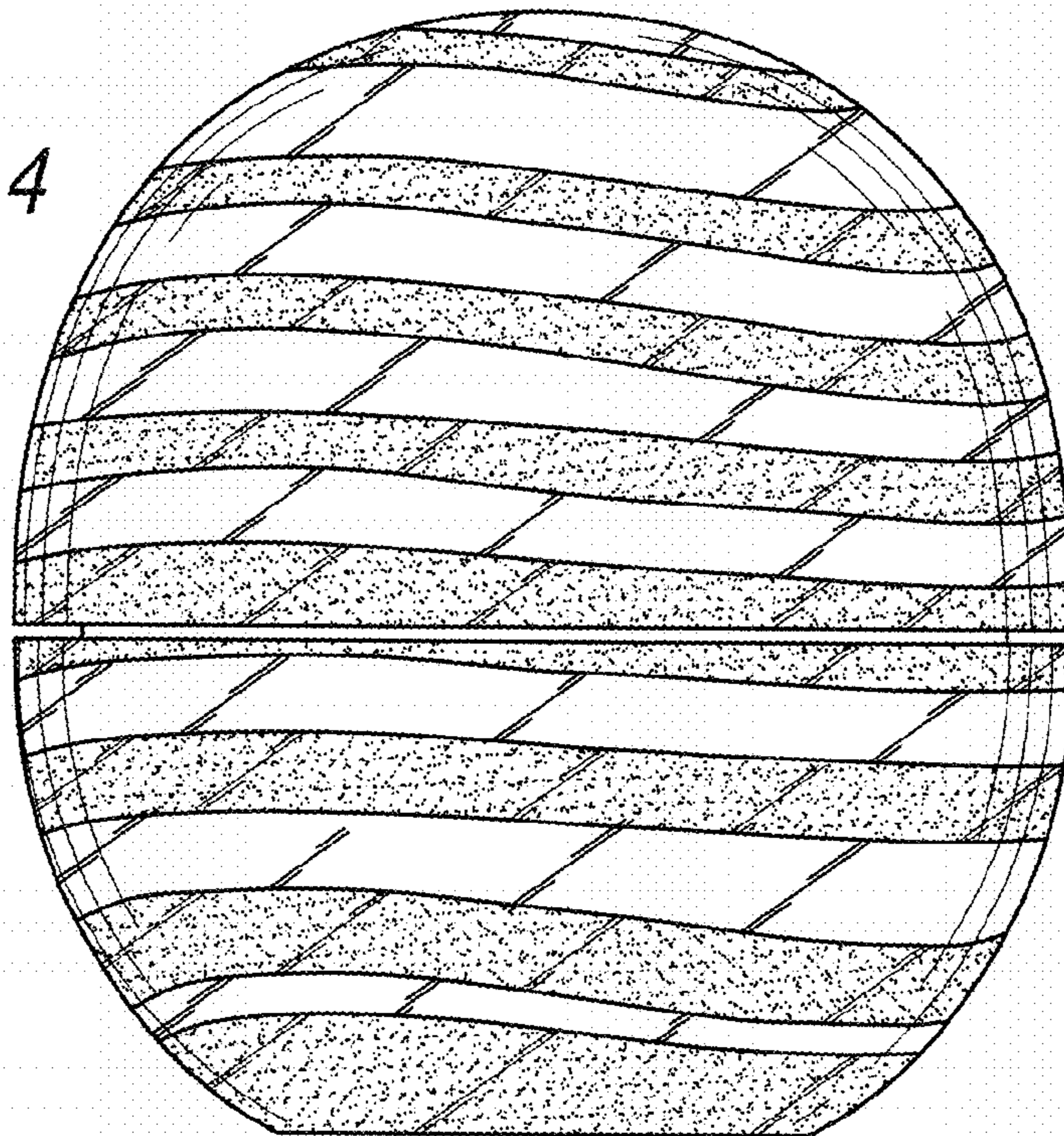

FIG. 5

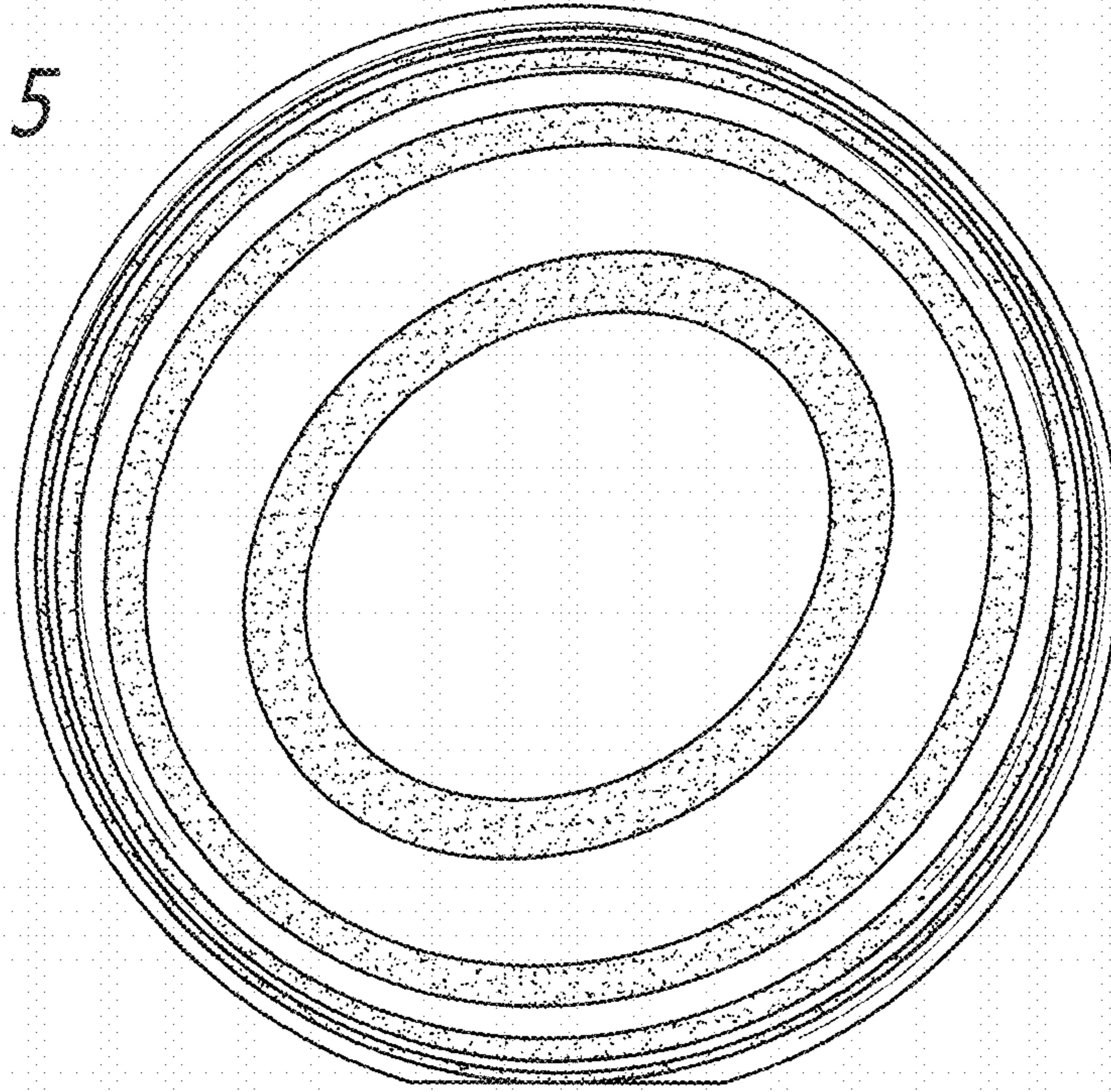

FIG. 6

