



US00D763389S

(12) **United States Design Patent**
Kim

(10) **Patent No.:** **US D763,389 S**

(45) **Date of Patent:** **** Aug. 9, 2016**

(54) **SWIMMING ASSISTANCE APPARATUS**

(71) Applicant: **Jeong Hun Kim**, Seoul (KR)

(72) Inventor: **Jeong Hun Kim**, Seoul (KR)

(**) Term: **14 Years**

(21) Appl. No.: **29/514,010**

(22) Filed: **Jan. 7, 2015**

(30) **Foreign Application Priority Data**

Oct. 8, 2014 (KR) 30-2014-0048425

Dec. 12, 2014 (KR) 30-2014-0060740

(51) **LOC (10) Cl.** **21-02**

(52) **U.S. Cl.**
USPC **D21/804**

(58) **Field of Classification Search**
USPC D21/804, 805; D29/100, 101.1, 101, 4;
2/456, 458, 467, 463; 441/88, 89, 106,
441/108, 111, 114-117
CPC B63C 9/115
See application file for complete search history.

(56) **References Cited**

U.S. PATENT DOCUMENTS

2,295,906 A 9/1942 Lacour
2,536,390 A 1/1951 Pobochenko

(Continued)

FOREIGN PATENT DOCUMENTS

JP 55-008531 U 1/1980
KR 20-0437315 Y1 11/2007

(Continued)

OTHER PUBLICATIONS

Tyr, "Hydrofoil Ankle Float", Accessed and Screen shots made on Dec. 3, 2015, <<http://www.tyr.com/shop/tyr-hydrofoil-ankle-float.html>>.

Primary Examiner — Zenia Bennett

(74) *Attorney, Agent, or Firm* — Novick, Kim & Lee, PLLC; Song Ho Lee

(57) **CLAIM**

The ornamental design for the swimming assistance apparatus, as shown and described.

DESCRIPTION

FIG. 1 is a perspective view of a swimming assistance apparatus according to a first embodiment of the new design; FIG. 2 is a front view thereof; FIG. 3 is a rear view thereof; FIG. 4 is a left side view thereof; FIG. 5 is a right side view thereof; FIG. 6 is a top plan view thereof; FIG. 7 is a bottom plan view thereof; FIG. 8 is a perspective view of a swimming assistance apparatus according to a second embodiment of the new design; FIG. 9 is a front view thereof; FIG. 10 is a rear view thereof; FIG. 11 is a left side view thereof; FIG. 12 is a right side view thereof; FIG. 13 is a top plan view thereof; FIG. 14 is a bottom plan view thereof; FIG. 15 is a perspective view of a swimming assistance apparatus according to a third embodiment of the new design; FIG. 16 is a front view thereof; FIG. 17 is a rear view thereof; FIG. 18 is a left side view thereof; FIG. 19 is a right side view thereof; FIG. 20 is a top plan view thereof; FIG. 21 is a bottom plan view thereof; FIG. 22 is a perspective view of a swimming assistance apparatus according to a fourth embodiment of the new design; FIG. 23 is a front view thereof; FIG. 24 is a rear view thereof; FIG. 25 is a left side view thereof; FIG. 26 is a right side view thereof; FIG. 27 is a top plan view thereof; and, FIG. 28 is a bottom plan view thereof.

1 Claim, 16 Drawing Sheets

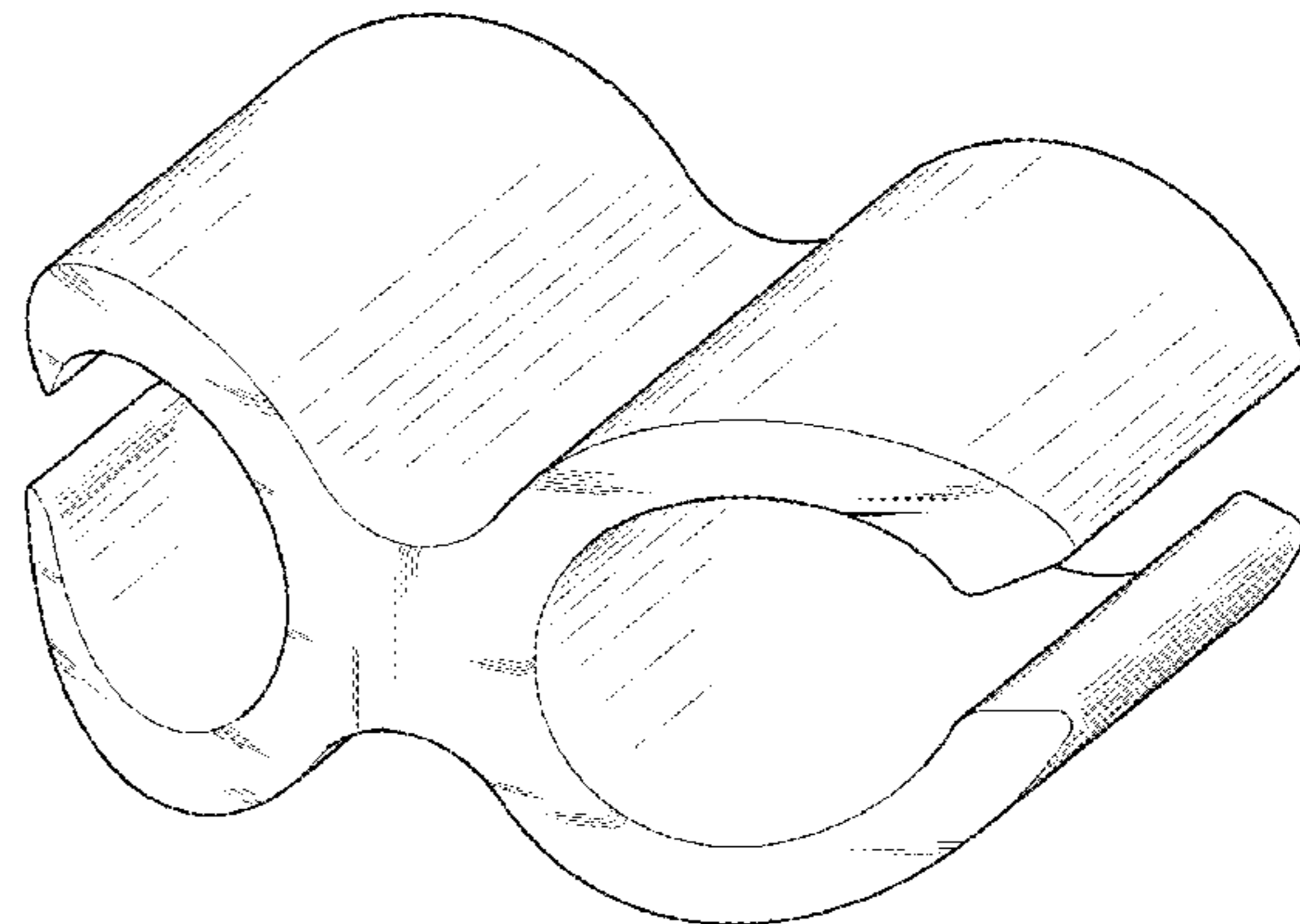
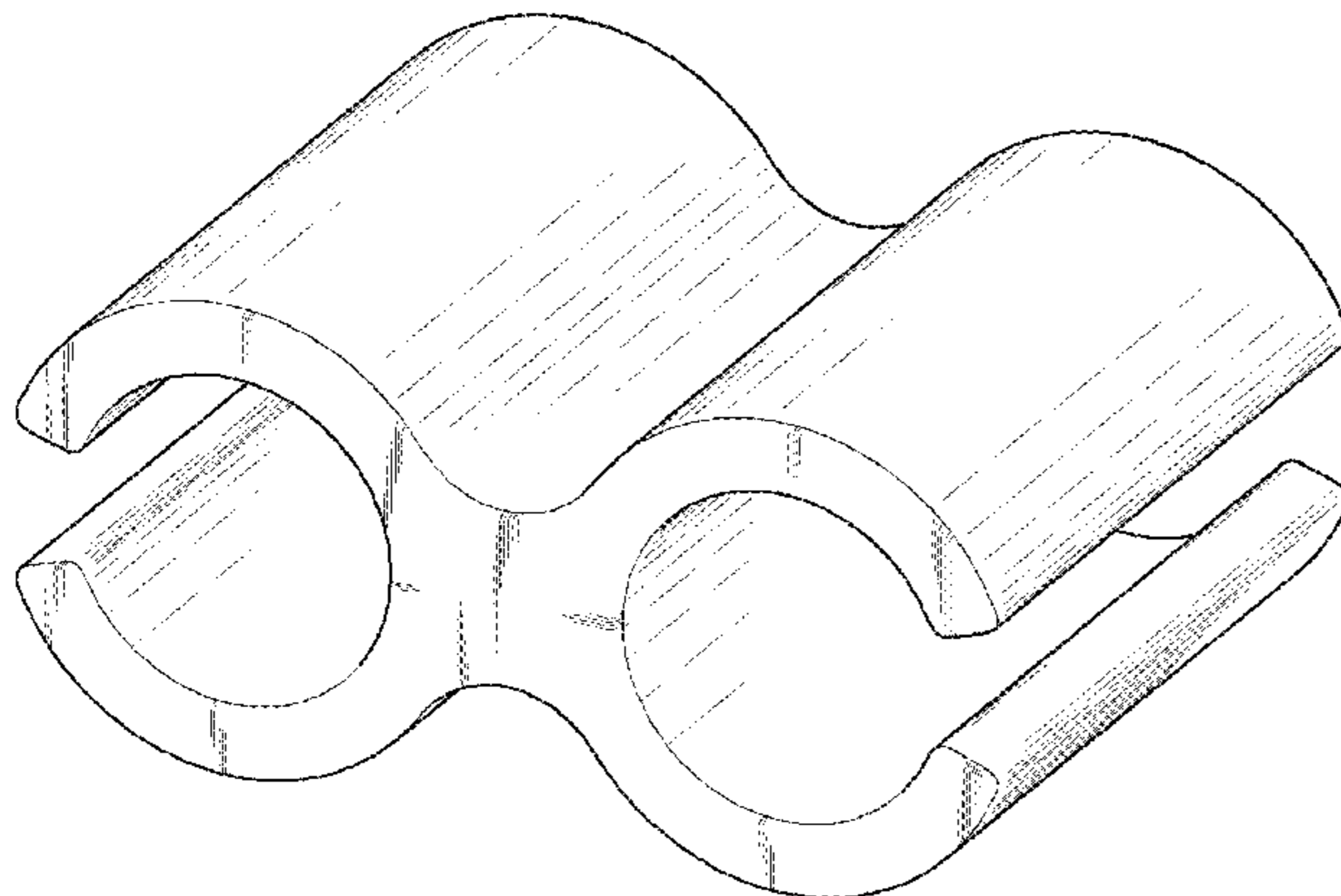

(56)

References Cited

U.S. PATENT DOCUMENTS

3,528,116 A 9/1970 Fenar
 3,604,023 A 9/1971 Lynch
 3,771,181 A 11/1973 Dansereau
 4,090,268 A 5/1978 Turner
 4,379,704 A * 4/1983 Rademacher A63B 69/14
 441/88
 D280,005 S 8/1985 Jones
 D284,436 S 7/1986 Hodges
 4,747,779 A 5/1988 Gerstung
 D320,059 S 9/1991 Bedortha et al.
 5,092,802 A 3/1992 Jones
 5,344,373 A 9/1994 Greene
 5,389,058 A 2/1995 Tinari
 5,443,409 A 8/1995 Adamson
 5,530,980 A 7/1996 Sommerhalter, Jr.
 5,628,714 A 5/1997 Philipson
 5,700,173 A * 12/1997 Lerro A63B 31/08
 441/57
 5,746,218 A 5/1998 Edge
 D396,076 S 7/1998 Muasher
 D410,132 S 5/1999 Hottenroth
 D420,716 S 2/2000 Kiefer et al.

6,154,905 A 12/2000 Frydman
 6,182,314 B1 2/2001 Frydman
 D447,568 S 9/2001 Hall et al.
 6,490,742 B2 12/2002 Hall et al.
 6,764,362 B1 7/2004 Wenzel
 6,793,549 B1 * 9/2004 Chiang A63B 31/00
 441/88
 D510,117 S 9/2005 Jones
 7,169,000 B1 1/2007 Hernandez et al.
 D579,706 S 11/2008 Cox et al.
 D672,421 S 12/2012 Conlan
 D732,131 S 6/2015 DiLorenzo et al.
 D739,909 S 9/2015 Mix et al.
 9,259,632 B2 * 2/2016 DiLorenzo A63B 69/12
 9,278,257 B2 * 3/2016 Kacar A63B 31/00
 2009/0075537 A1 3/2009 Devers
 2015/0259055 A1 * 9/2015 Nakamoto B63C 9/155
 441/60

FOREIGN PATENT DOCUMENTS

KR 10-1323112 B1 11/2013
 KR 10-1559659 B1 10/2015

* cited by examiner

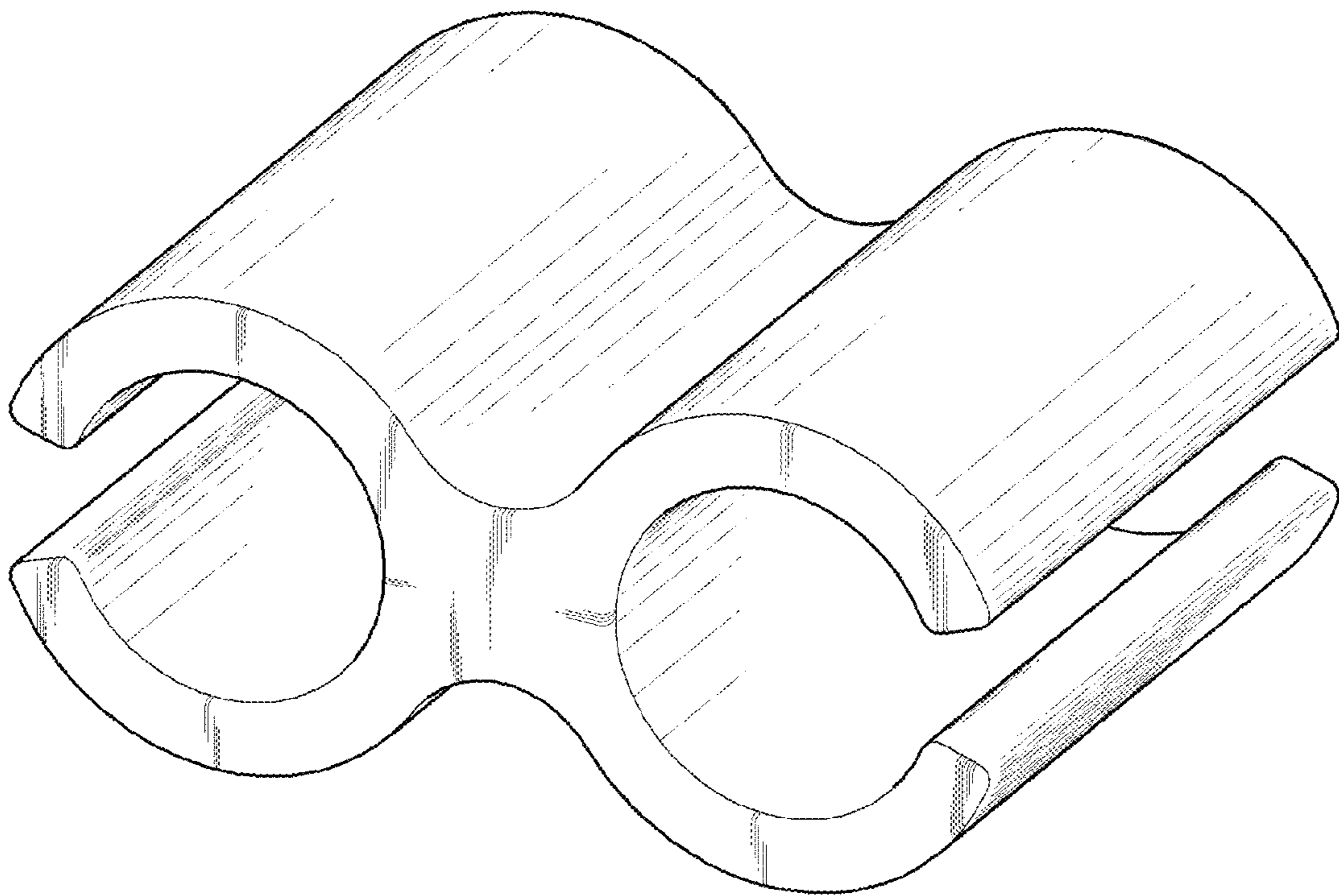

FIG. 1

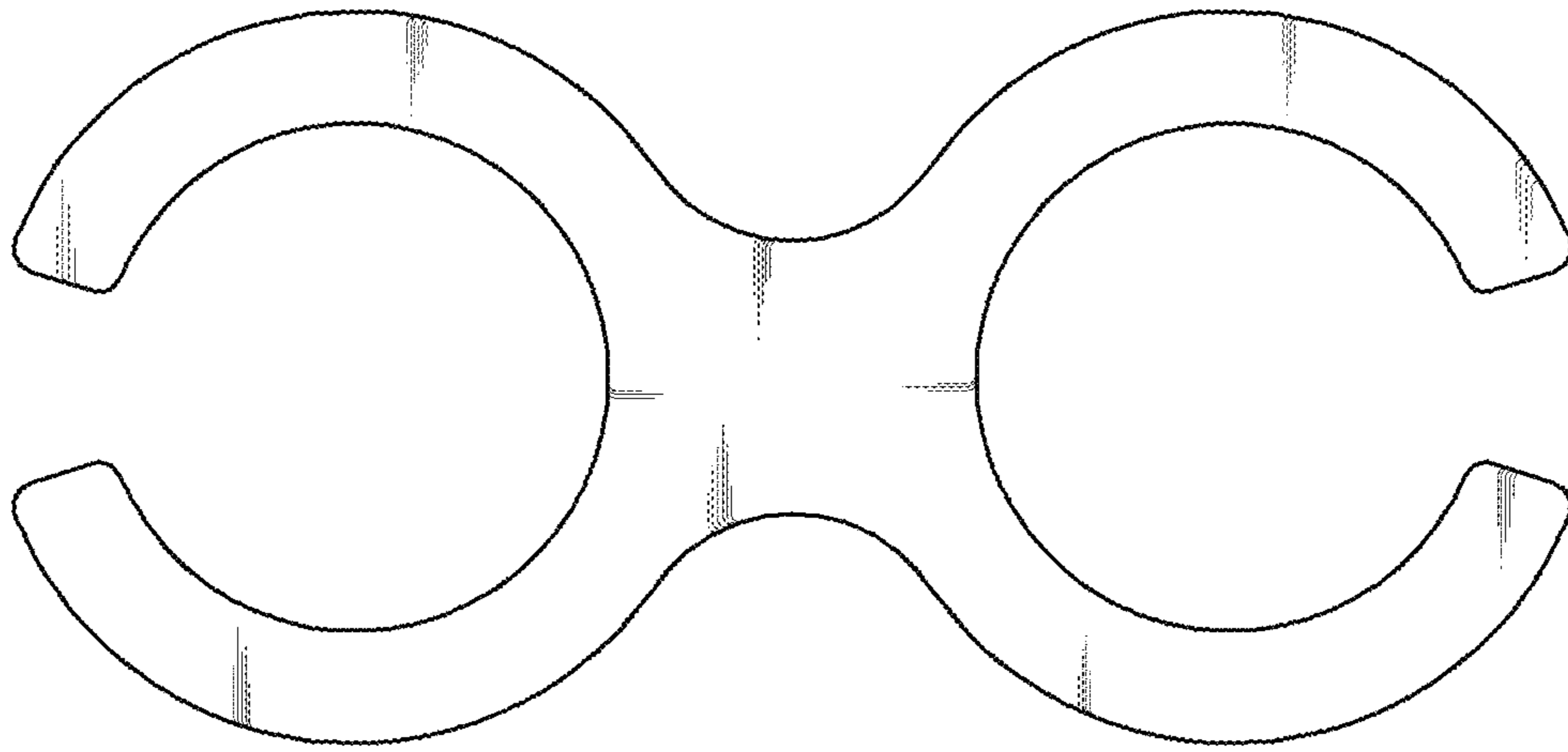

FIG. 2

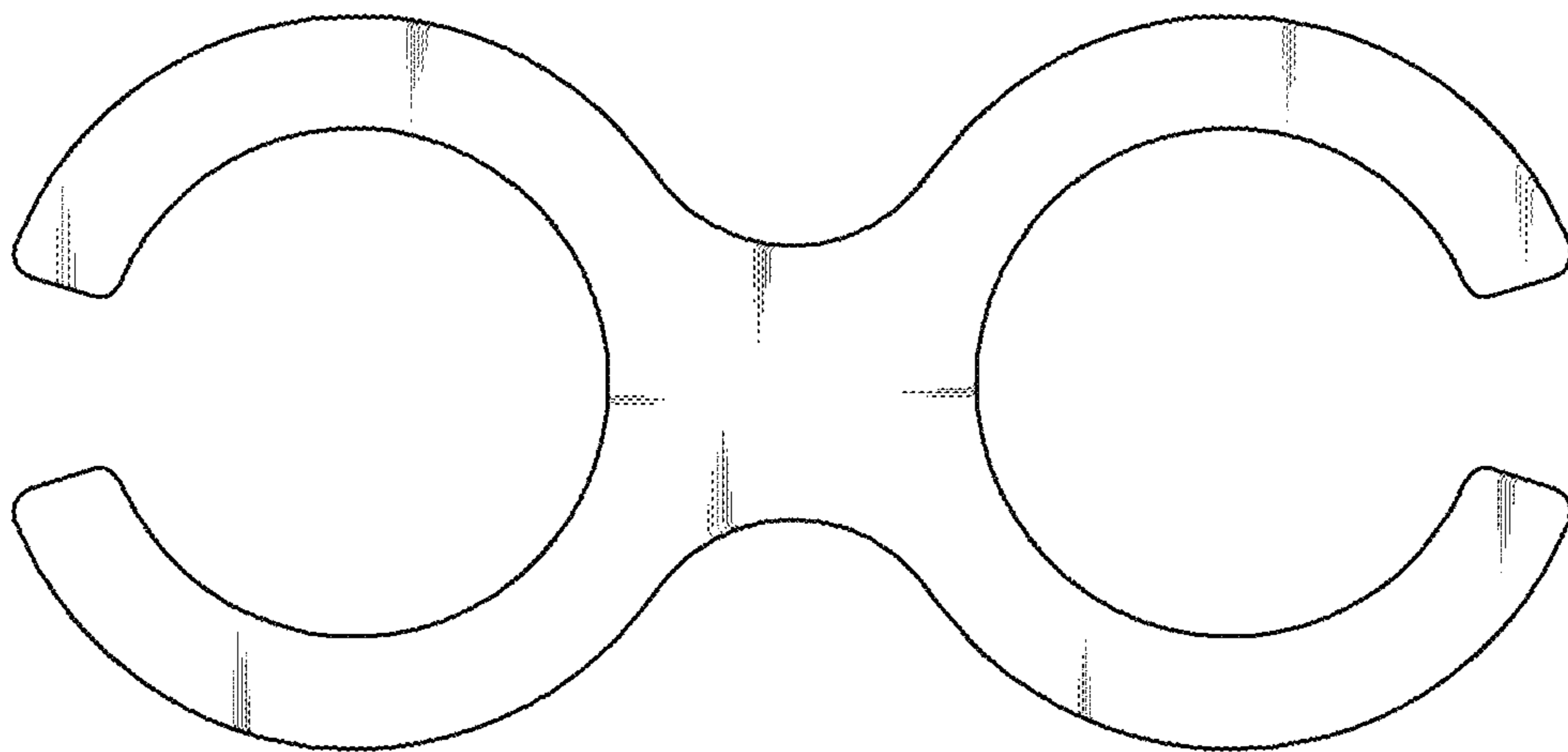

FIG. 3



FIG. 4

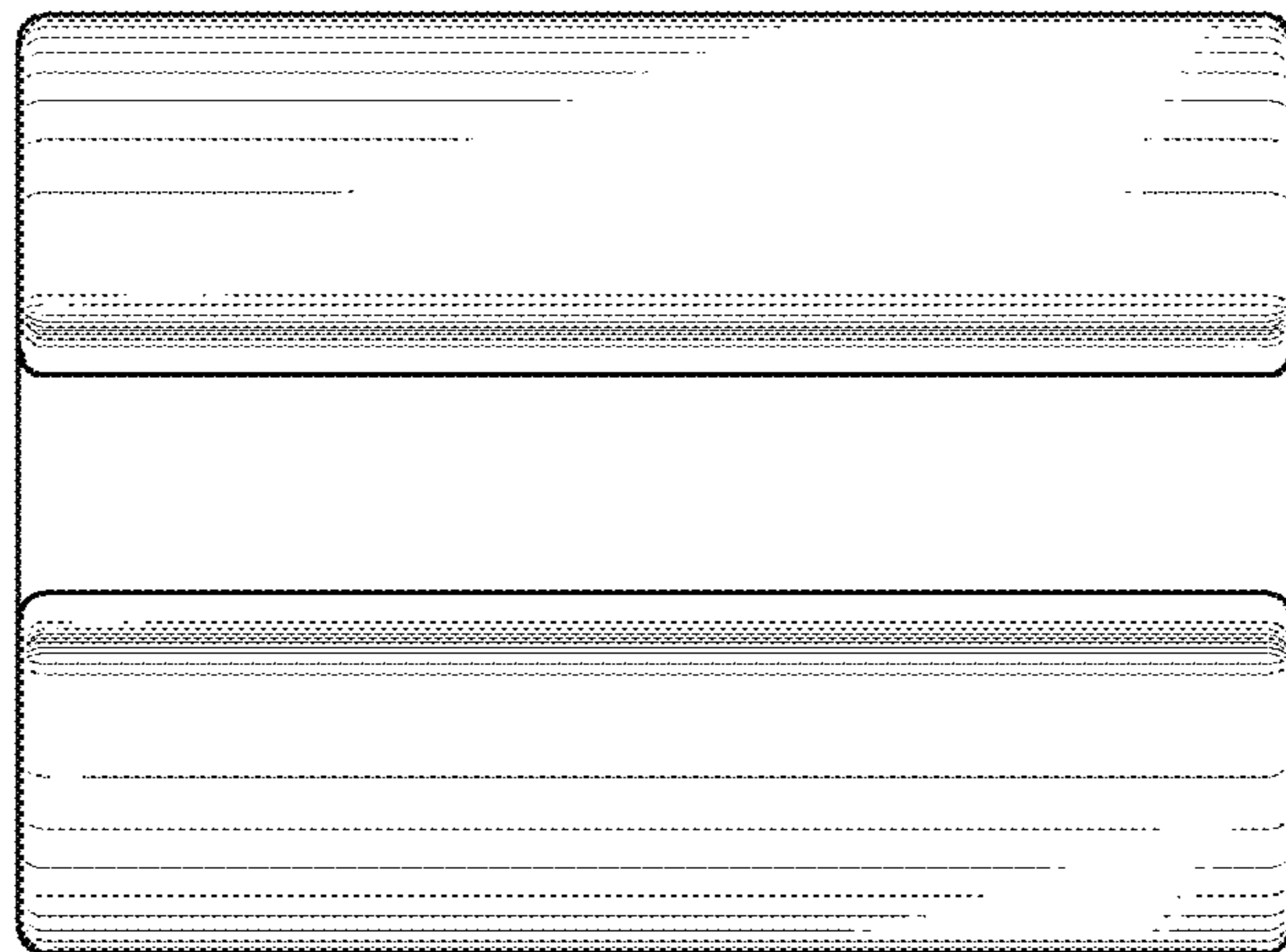

FIG. 5

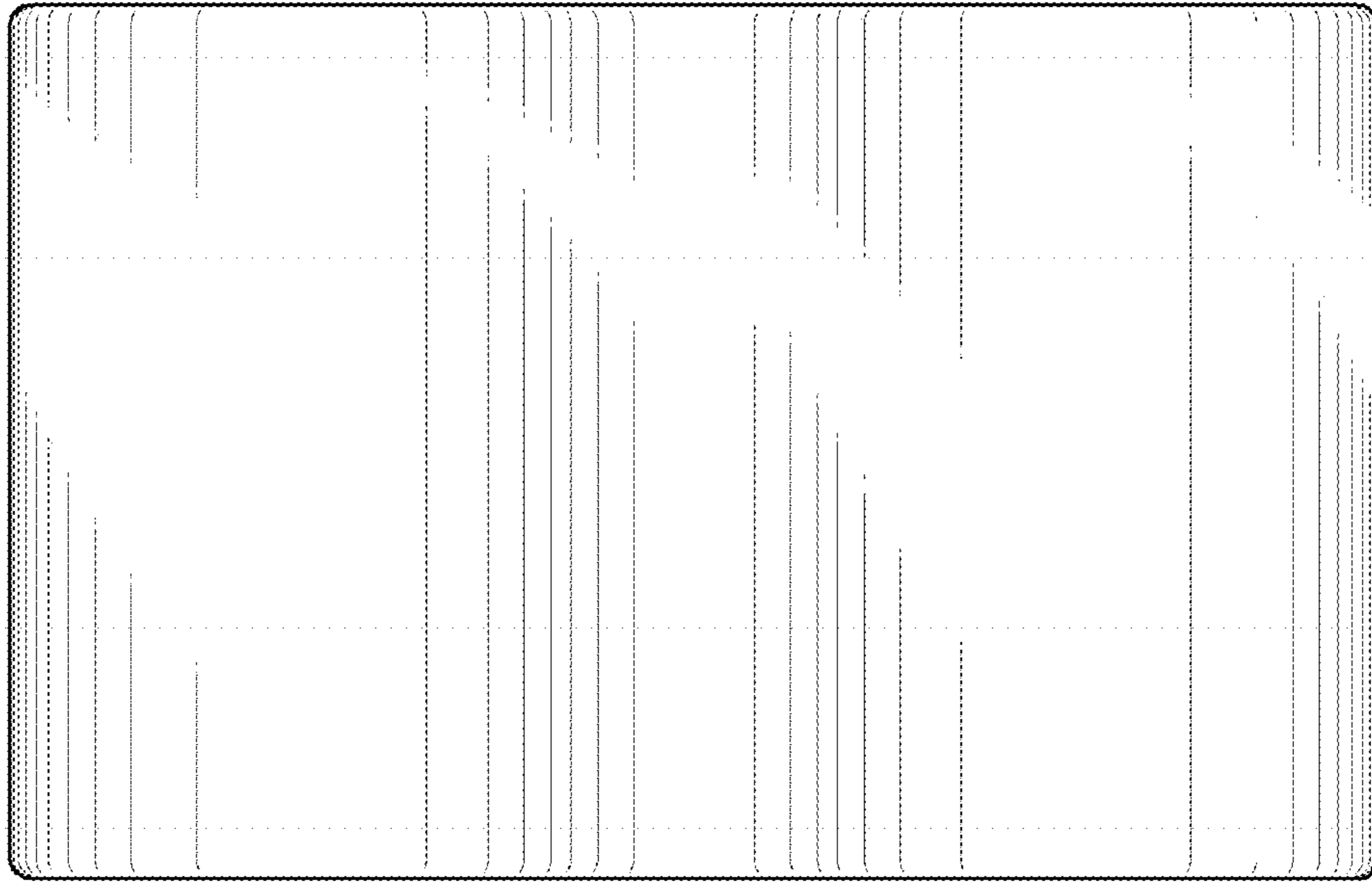

FIG. 6

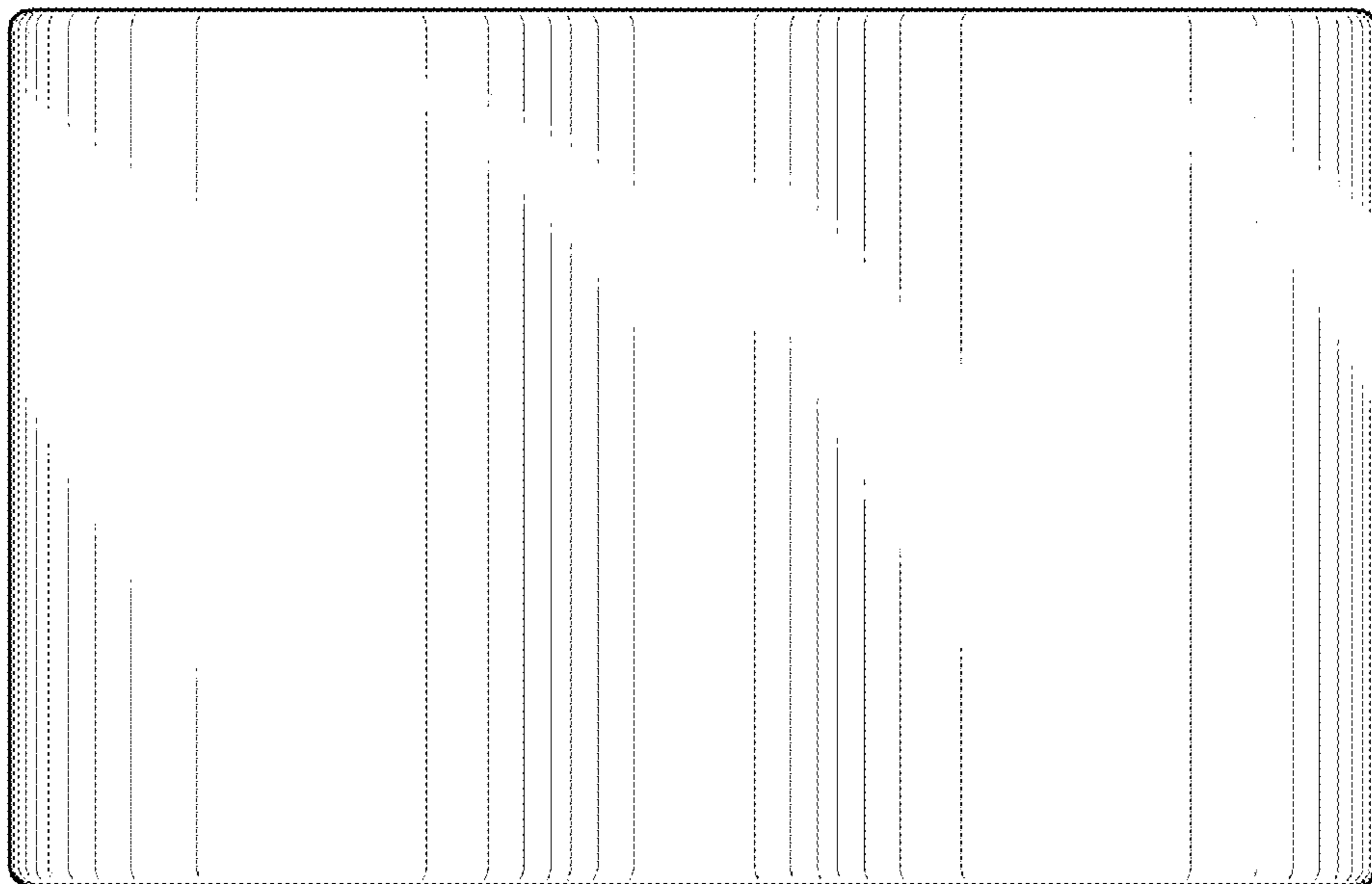

FIG. 7

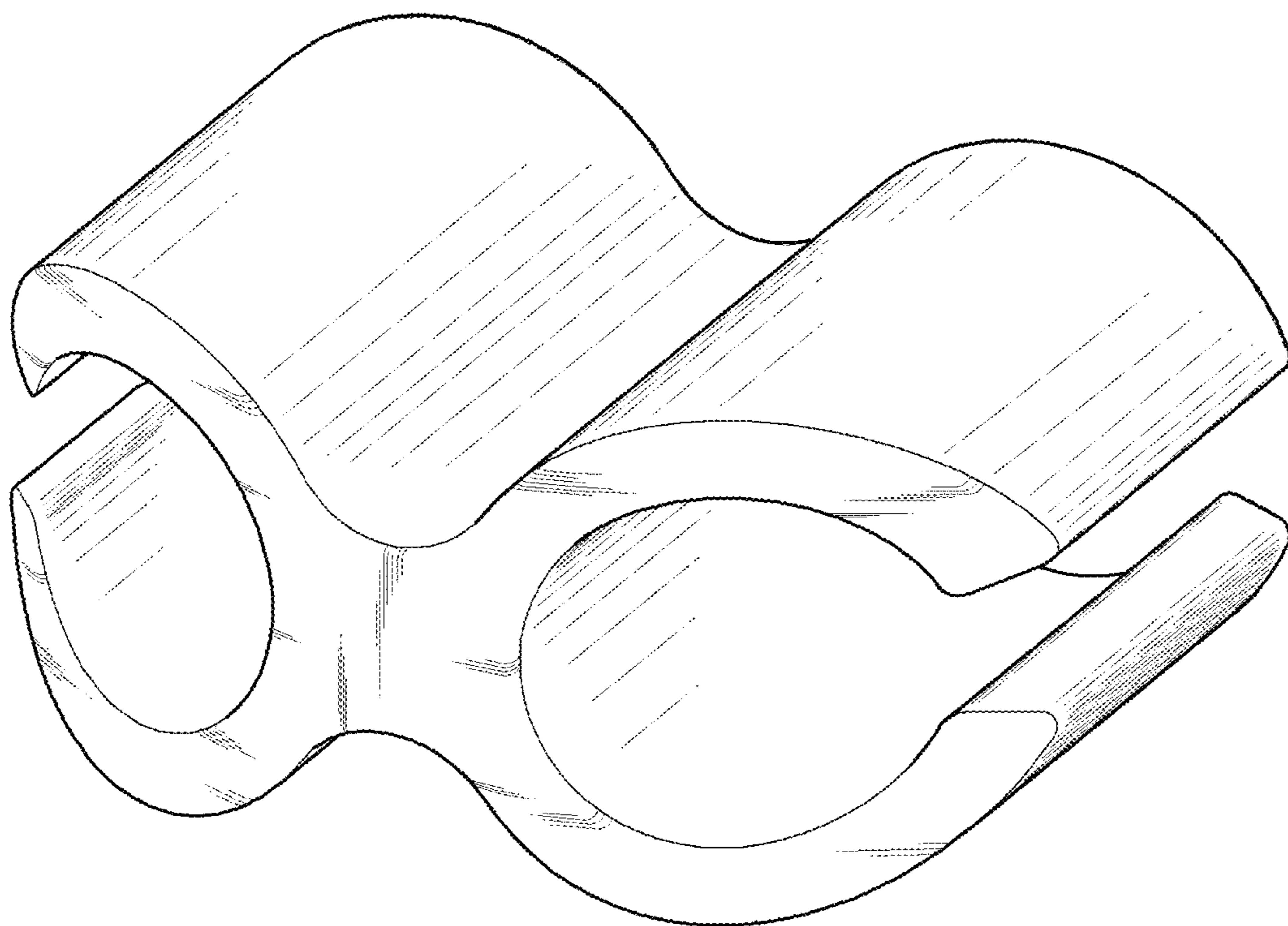

FIG. 8

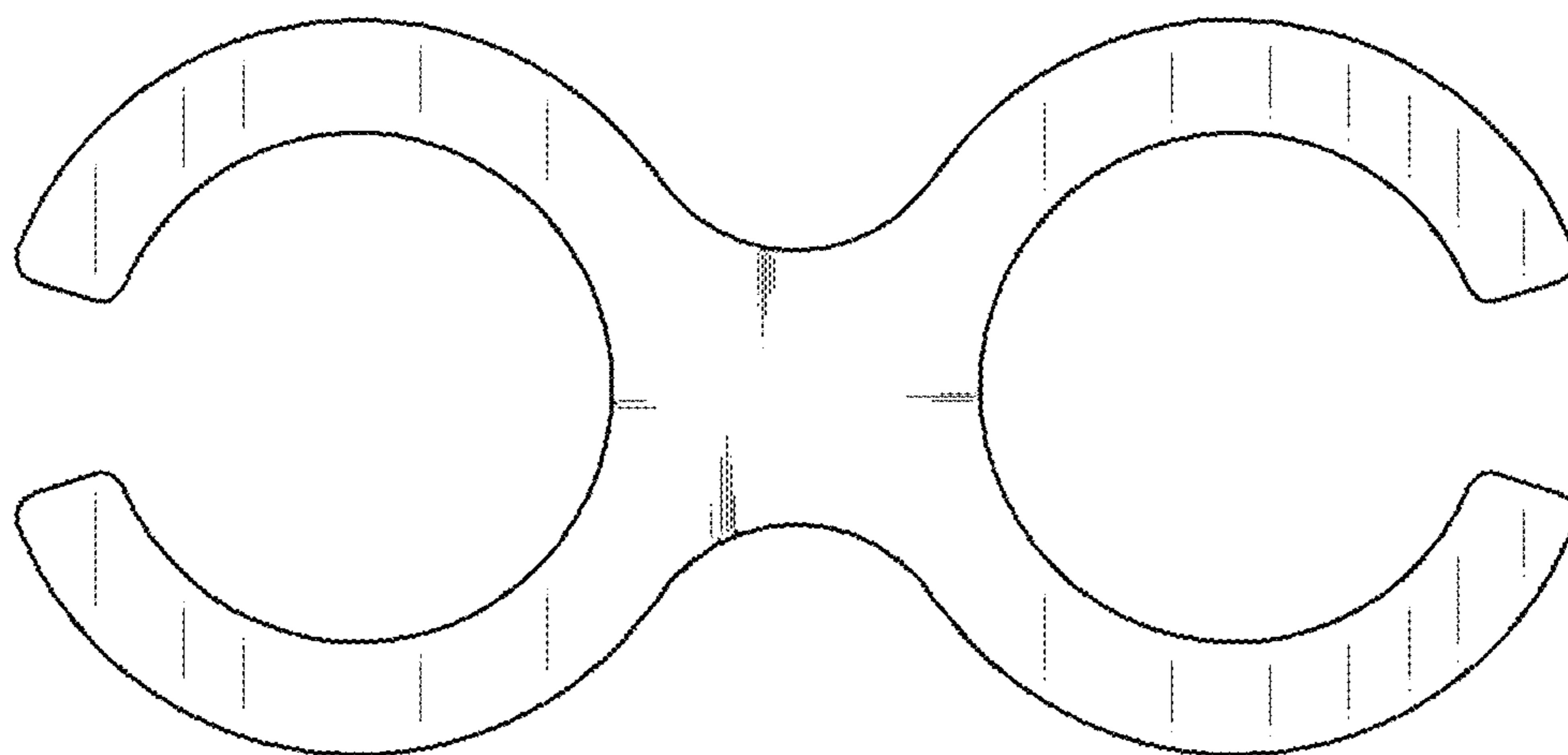

FIG. 9

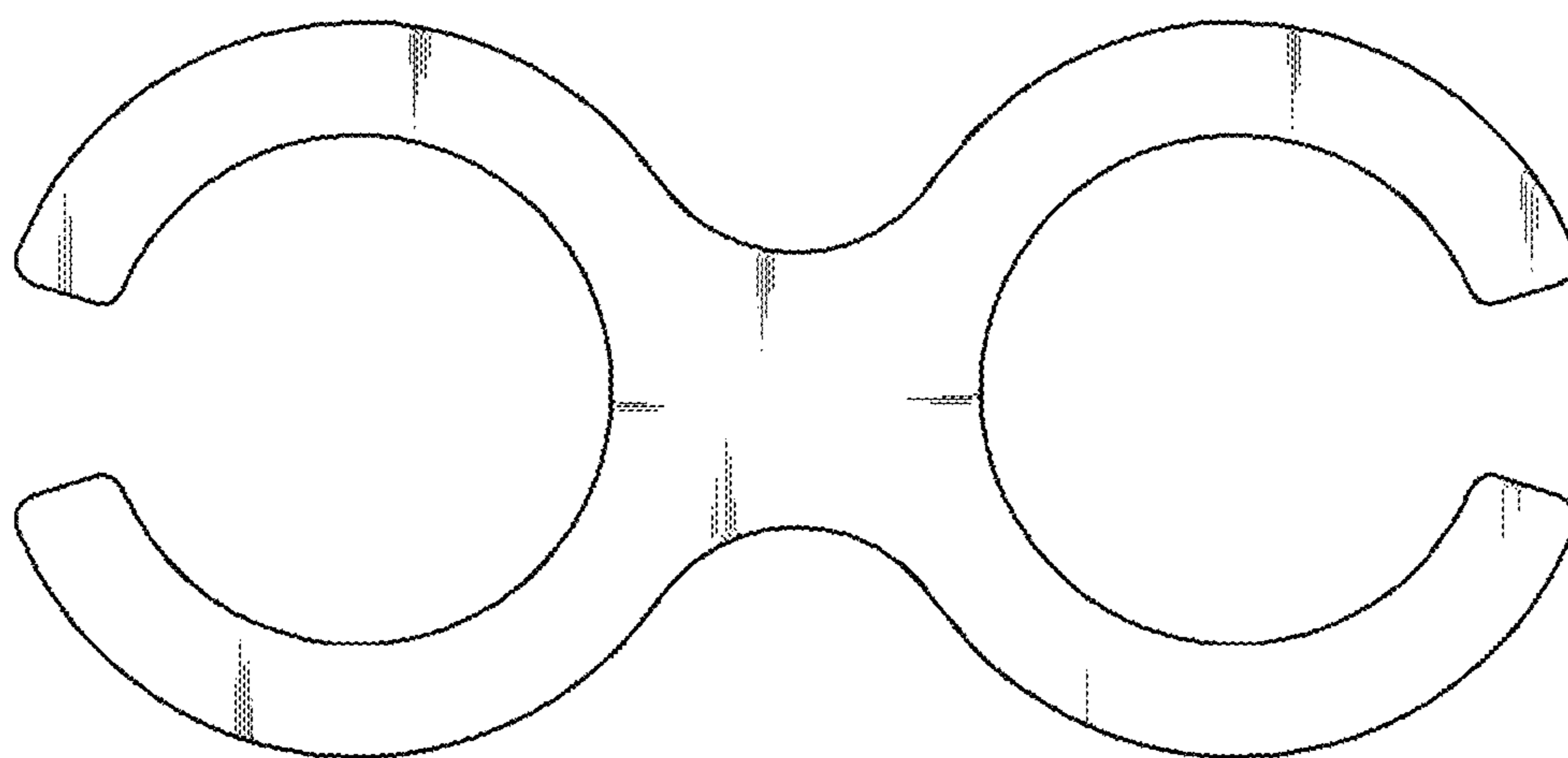

FIG. 10

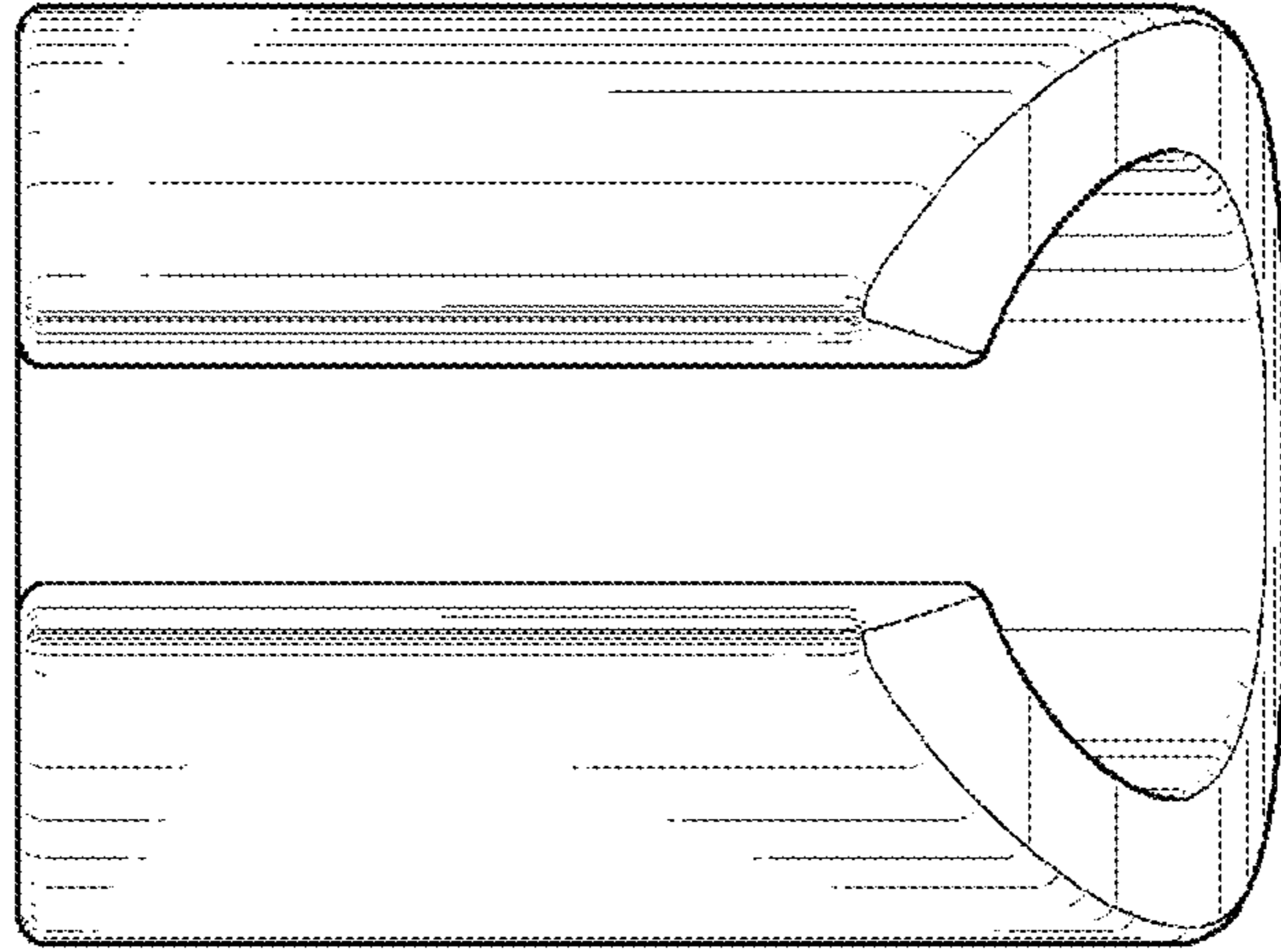

FIG. 11

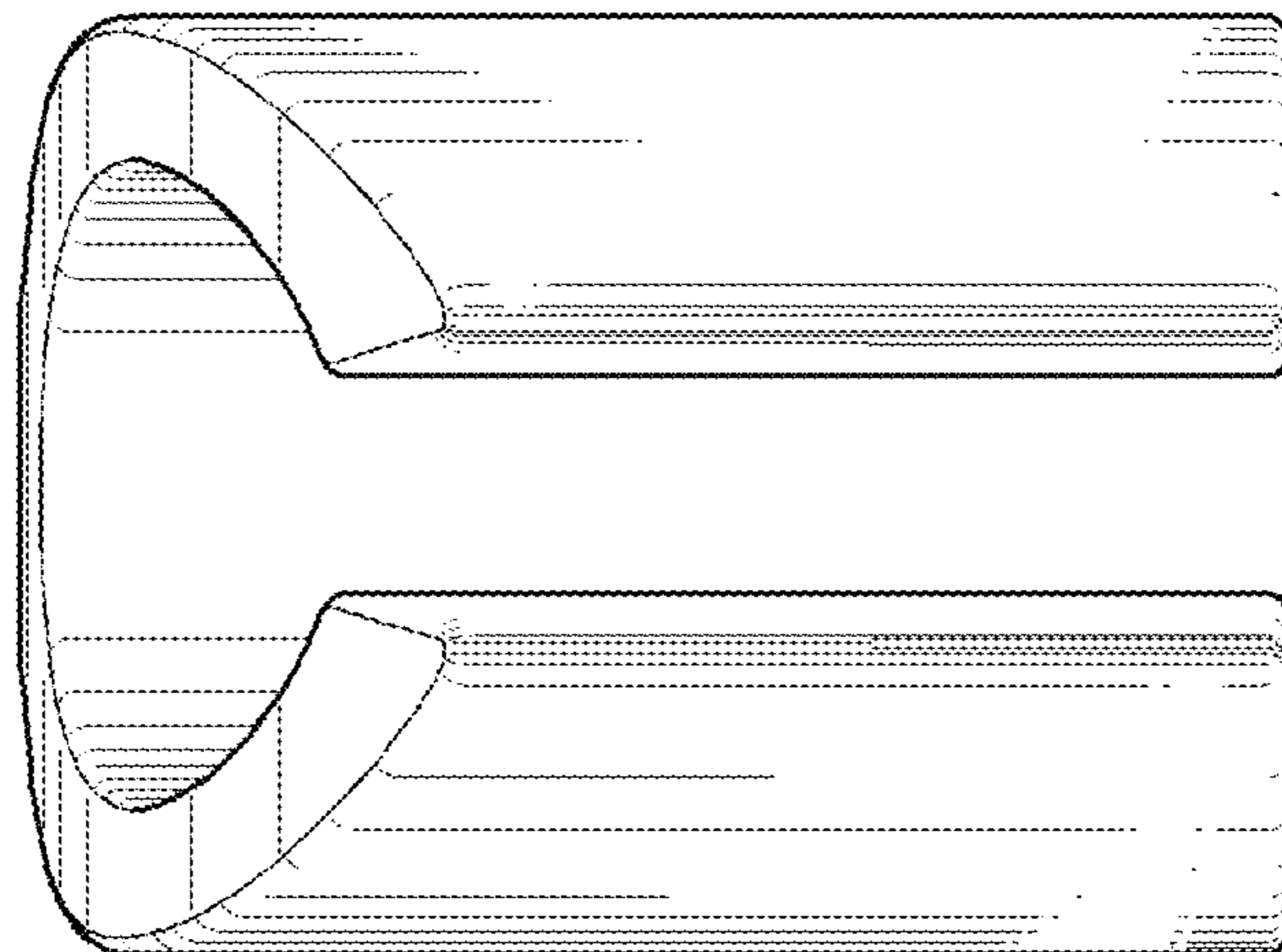

FIG. 12

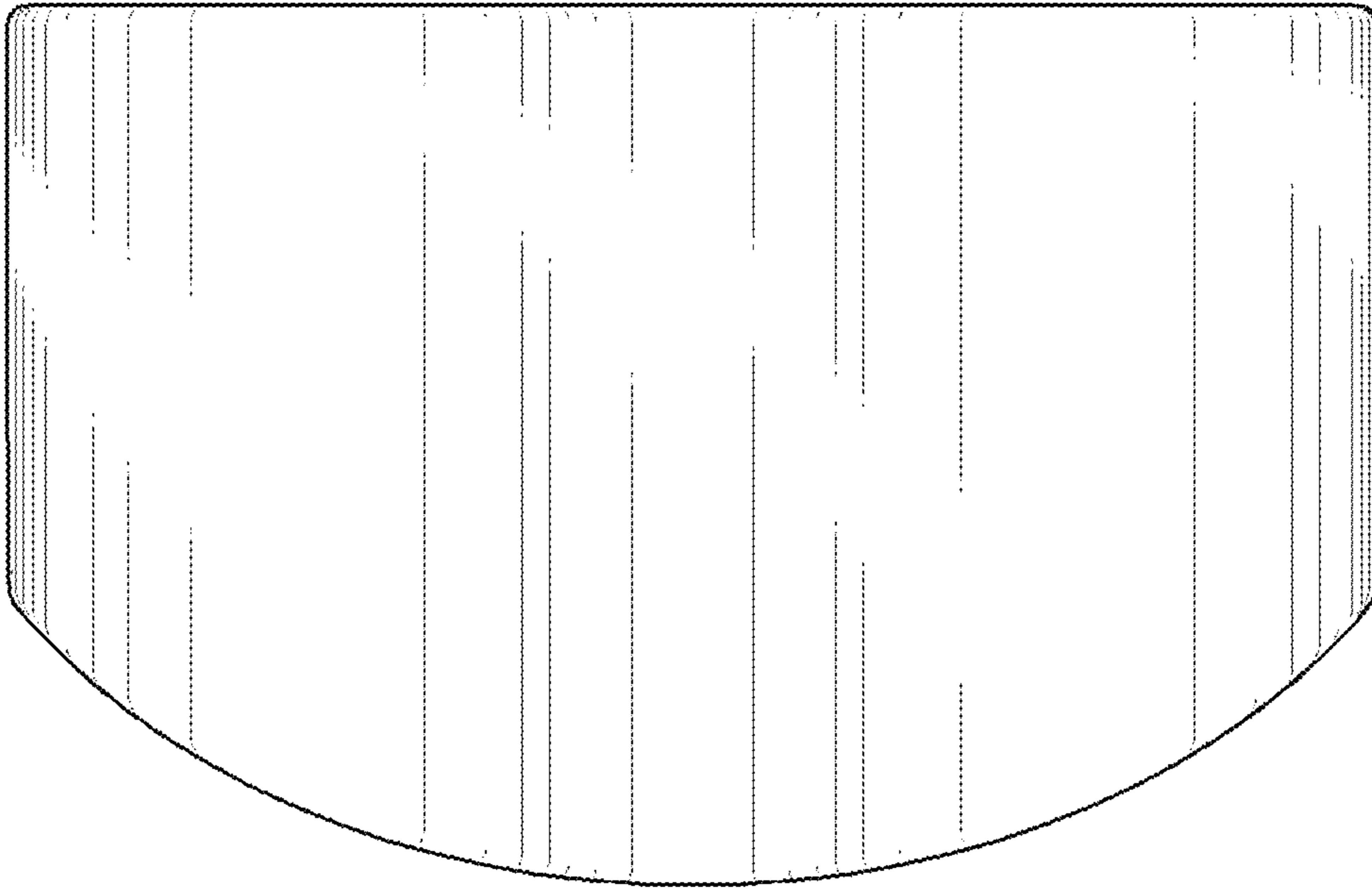

FIG. 13

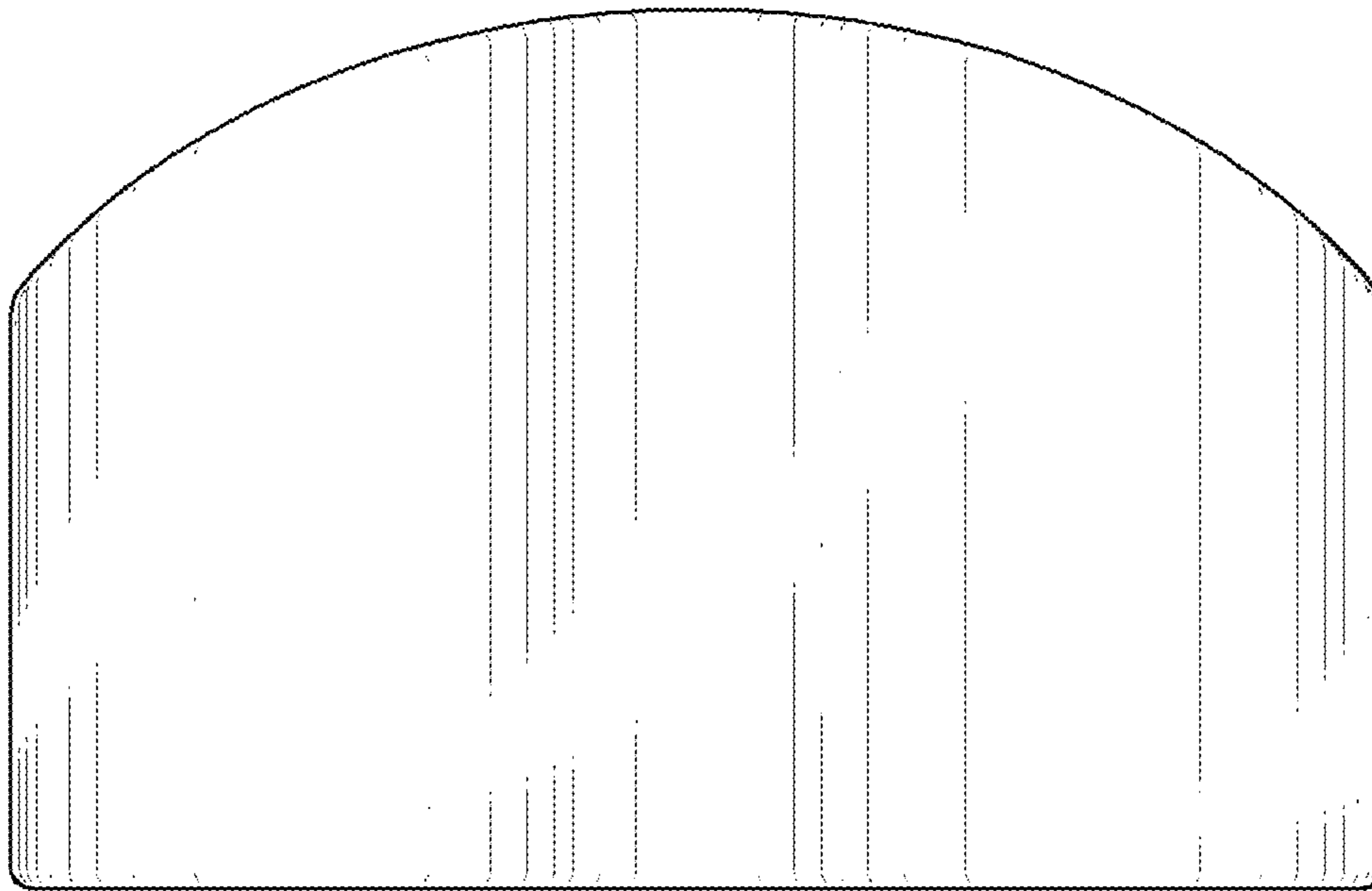

FIG. 14

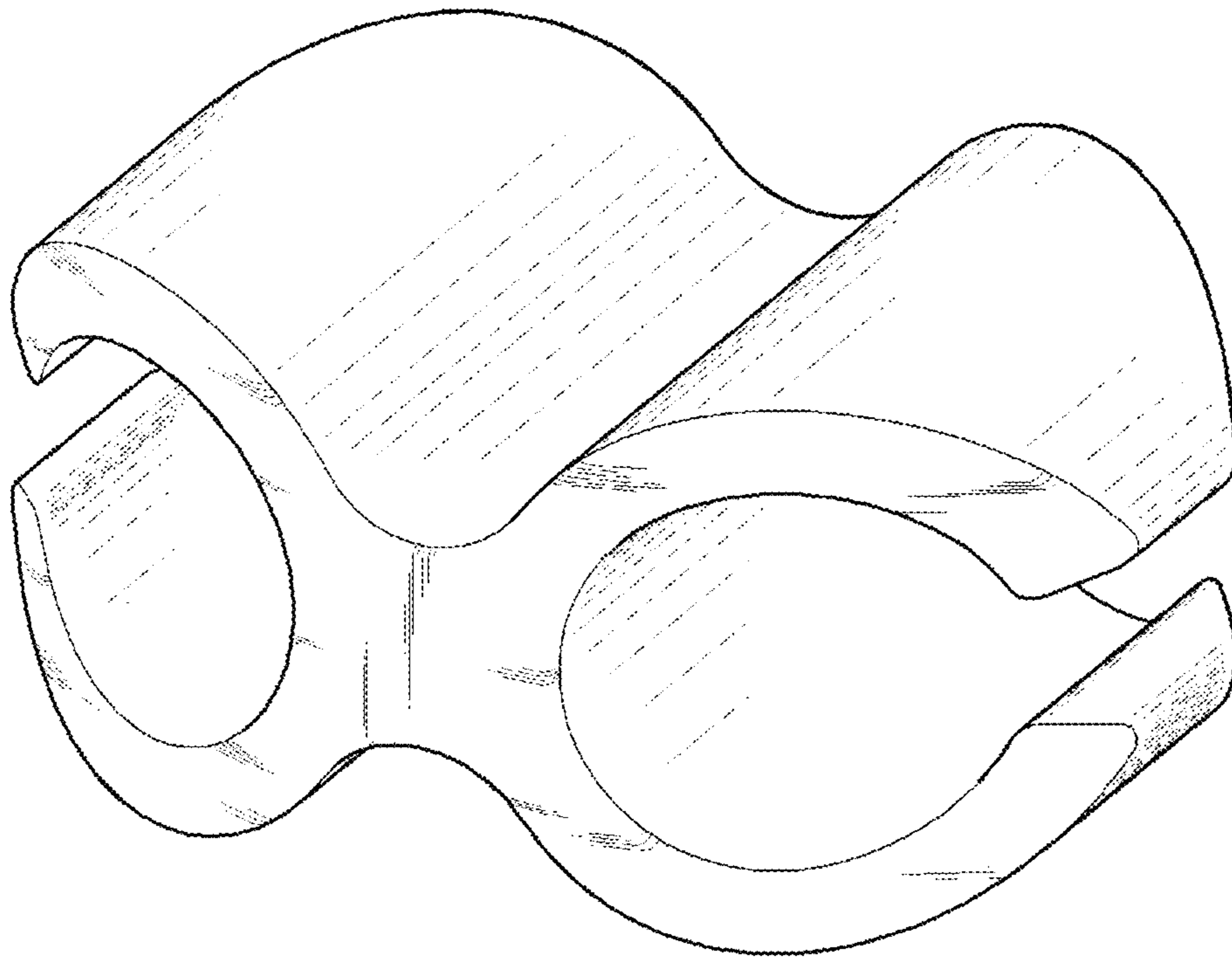

FIG. 15

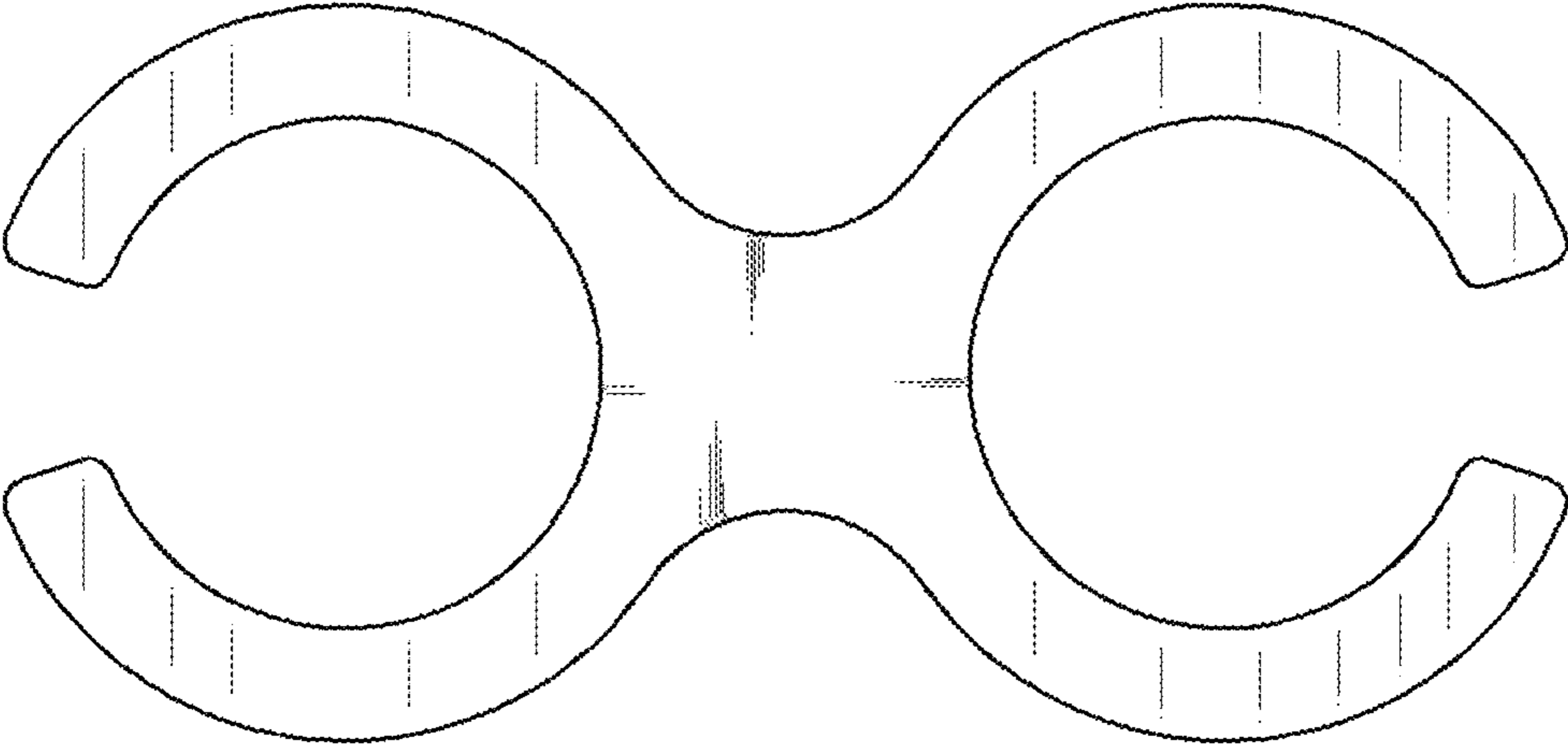

FIG. 16

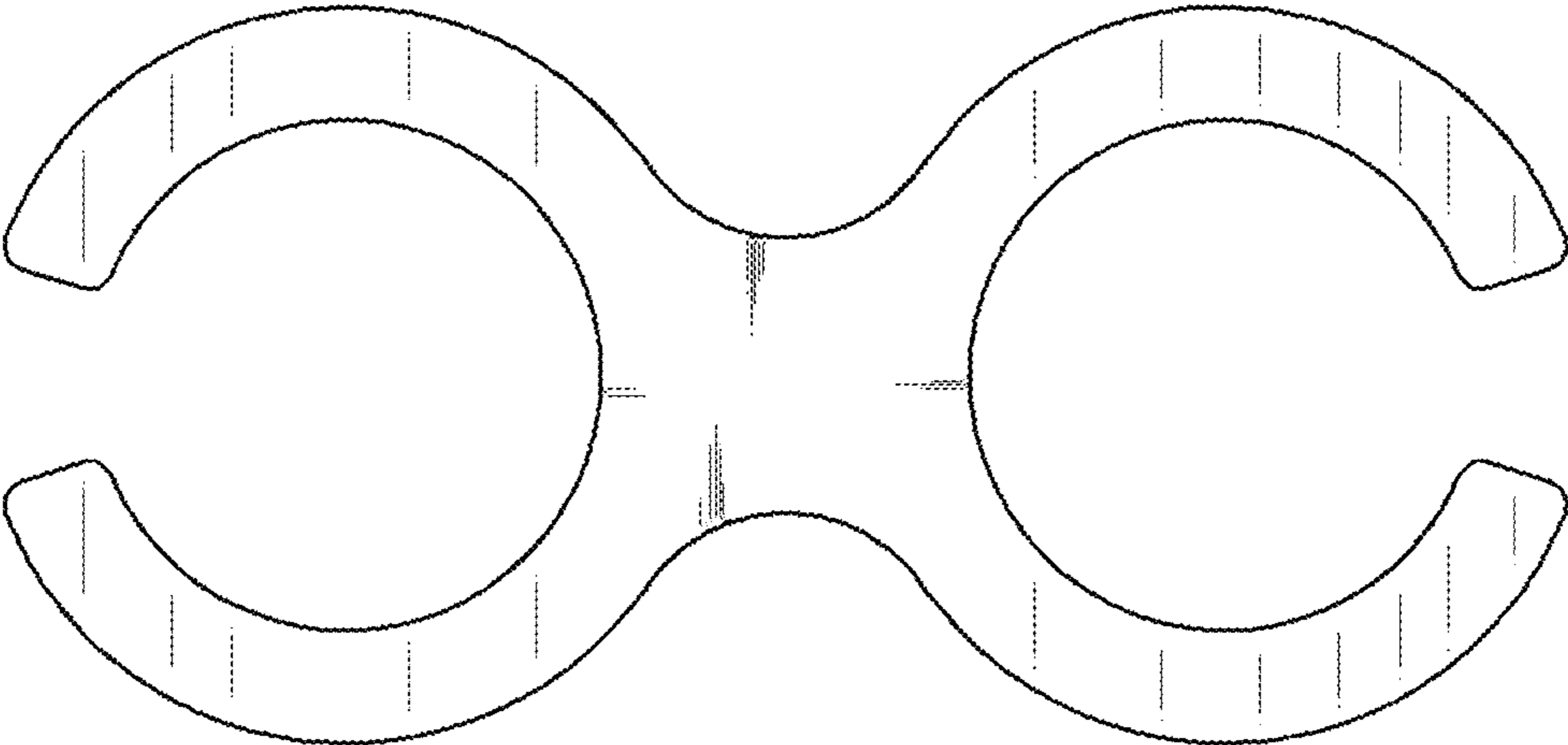

FIG. 17

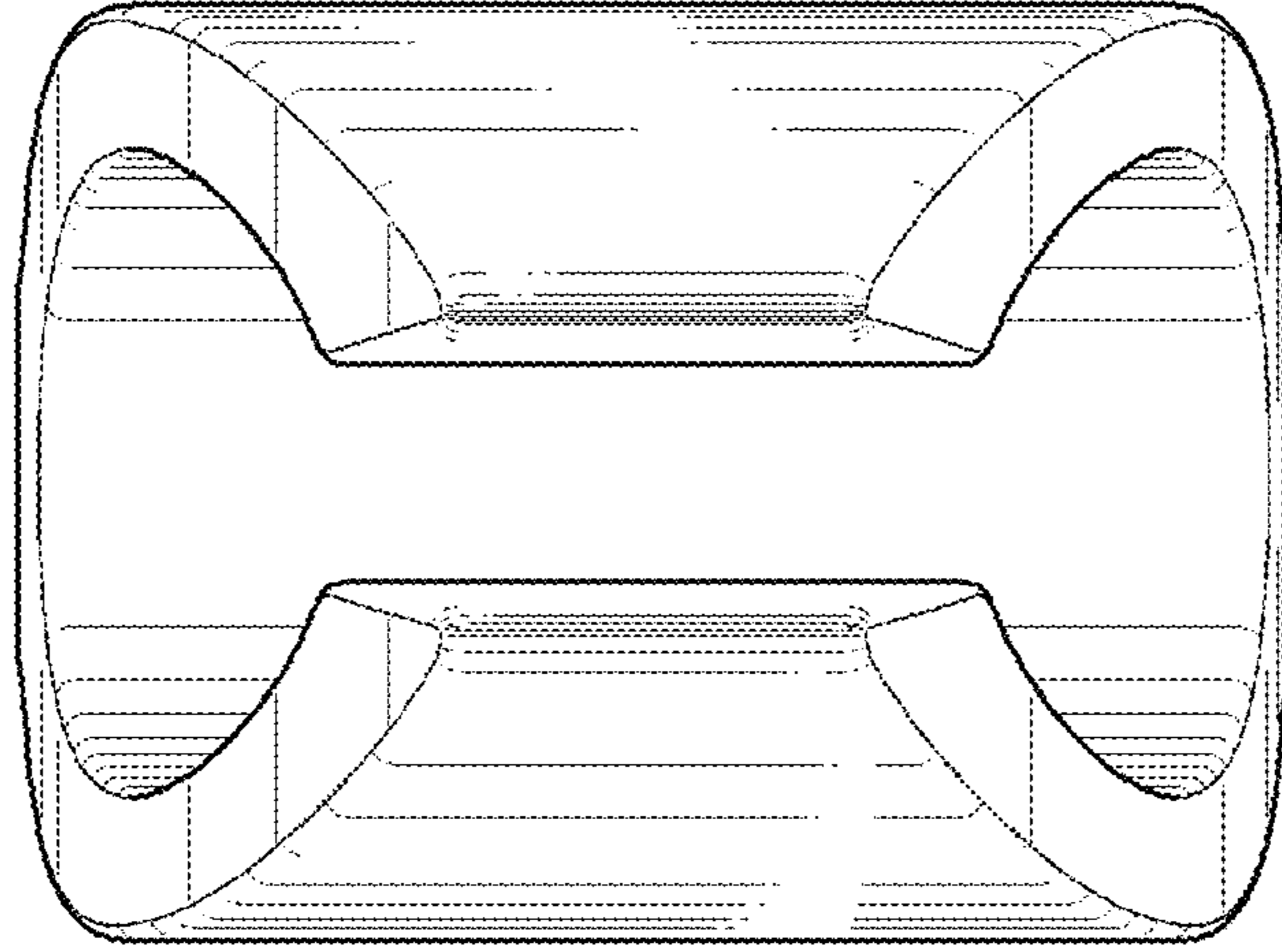

FIG. 18

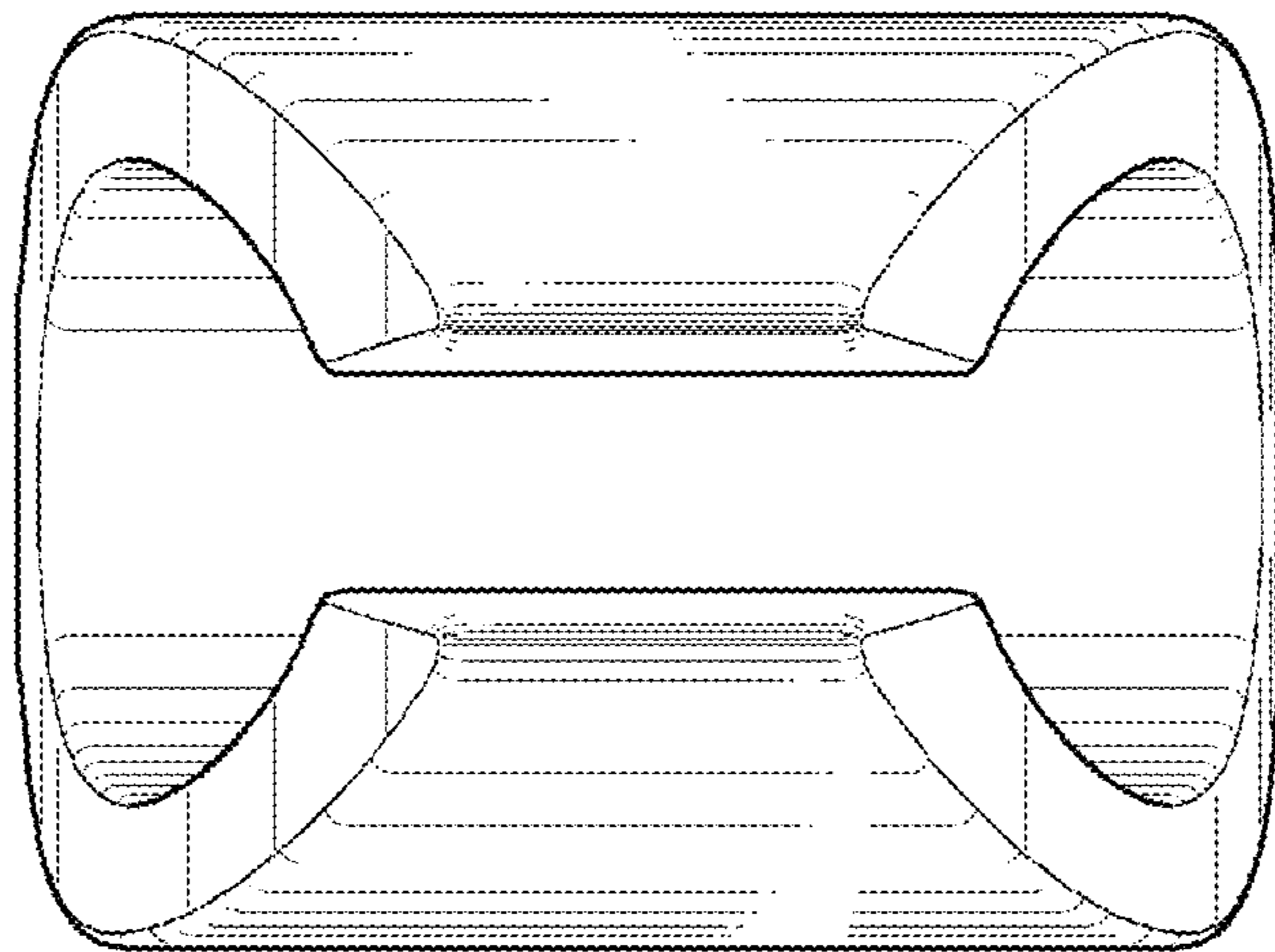

FIG. 19

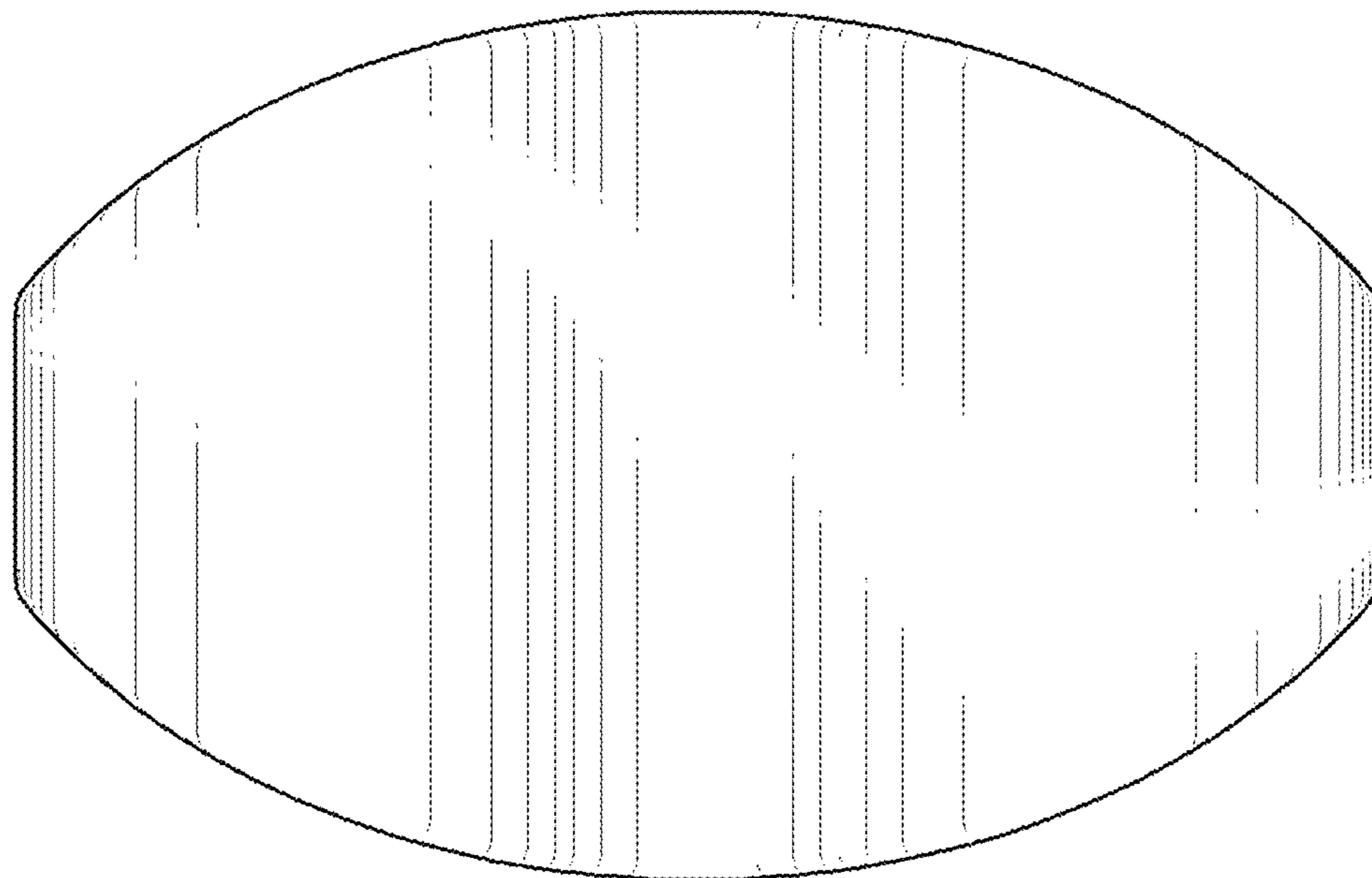

FIG. 20

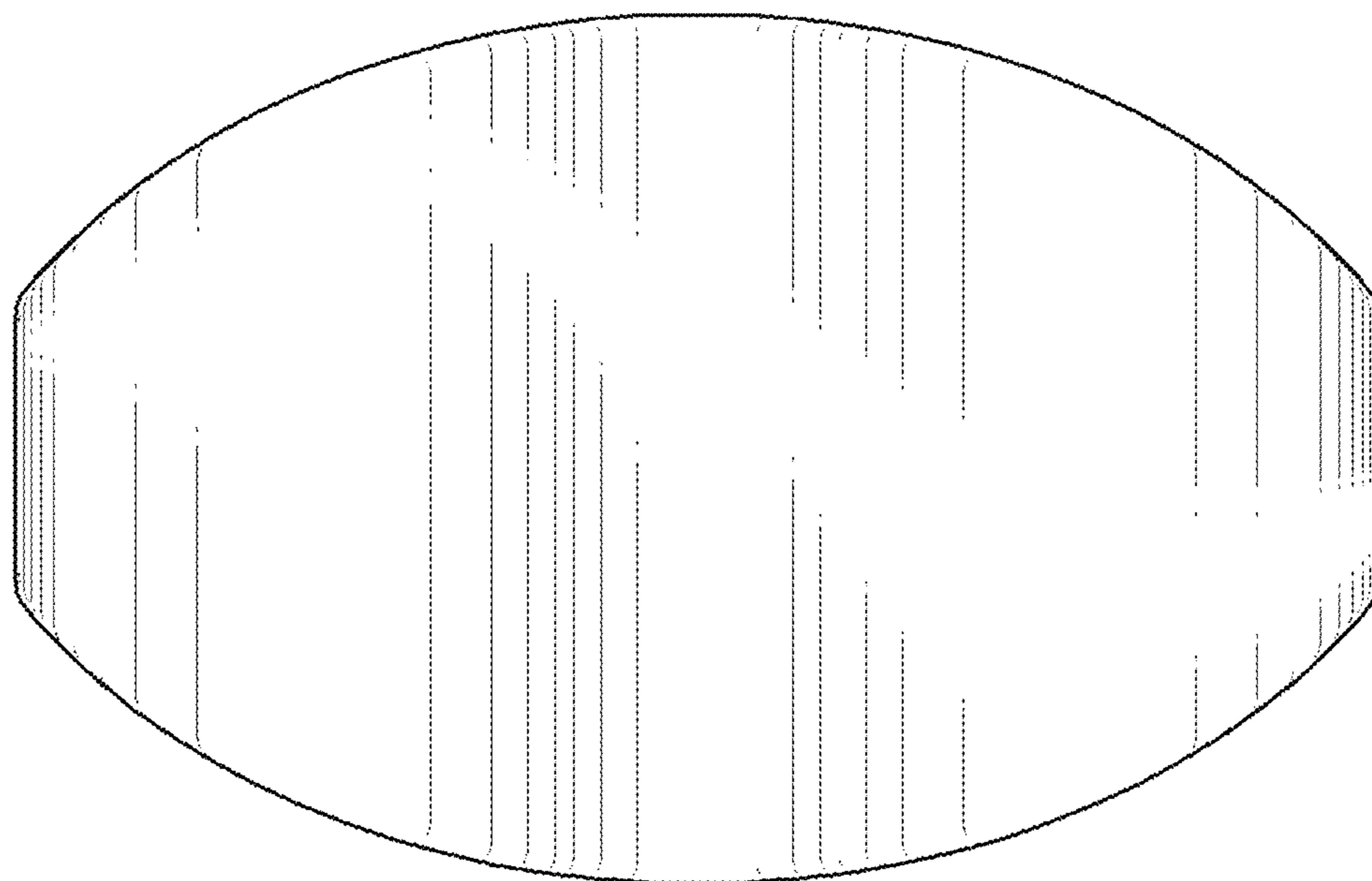

FIG. 21

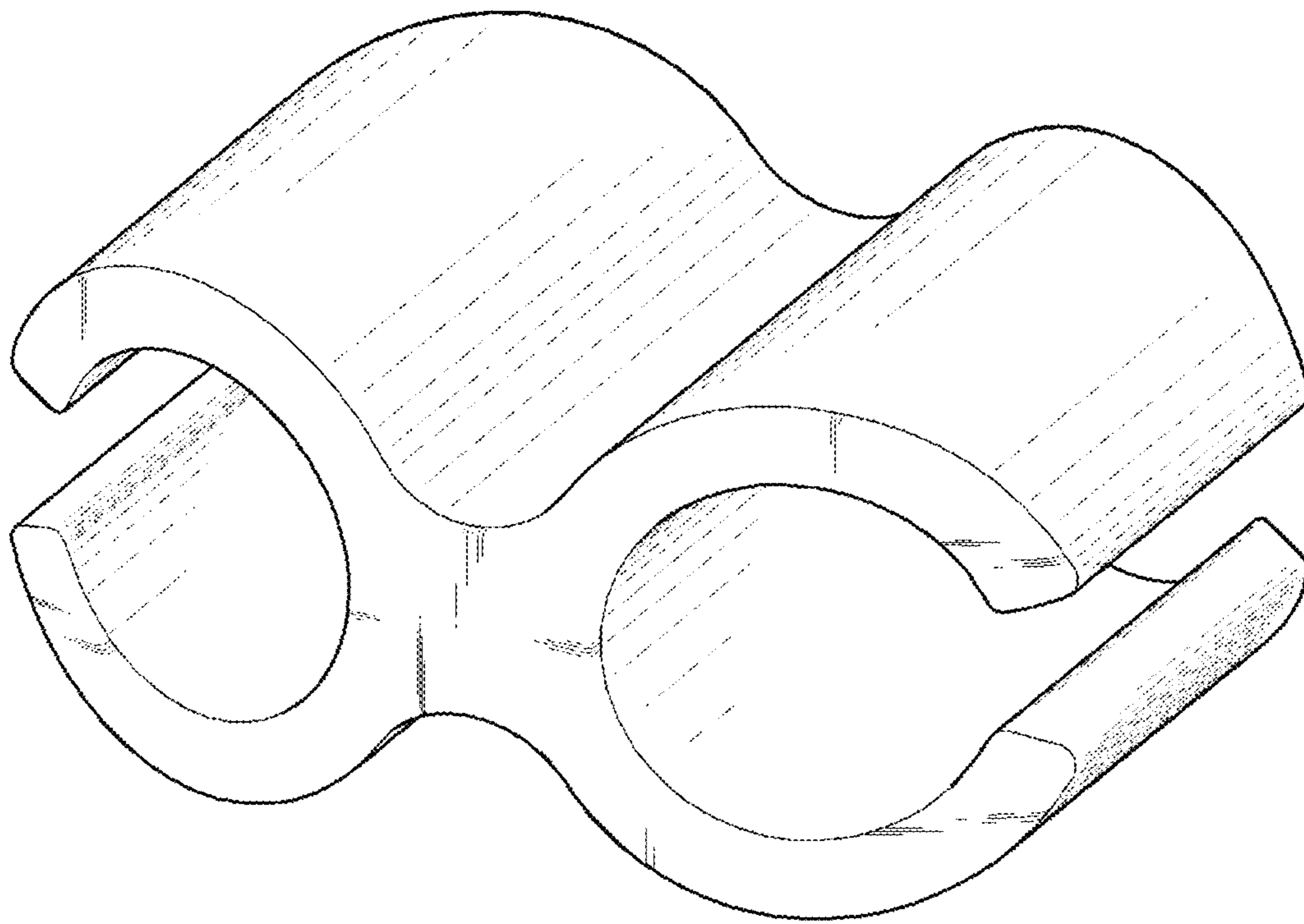

FIG. 22

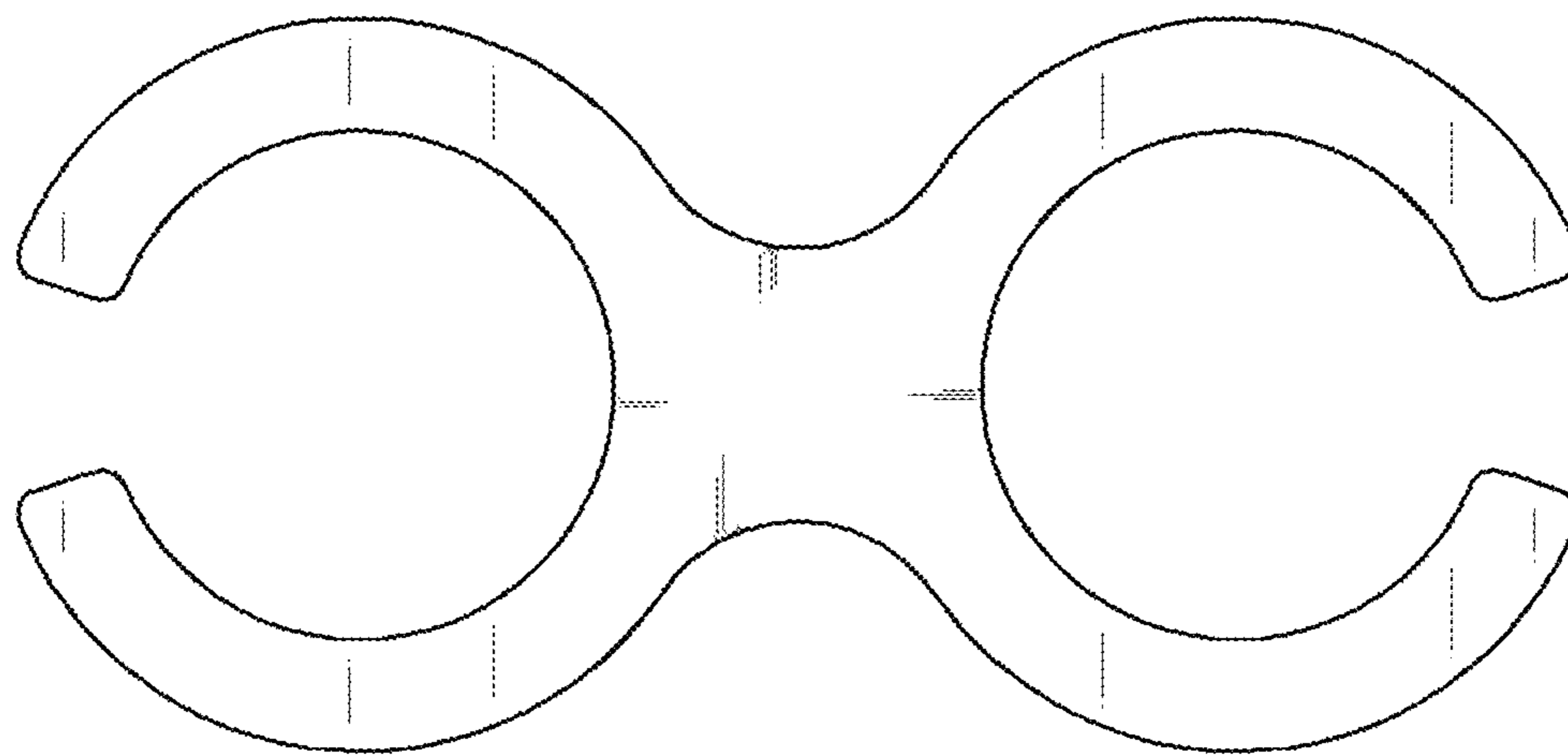

FIG. 23

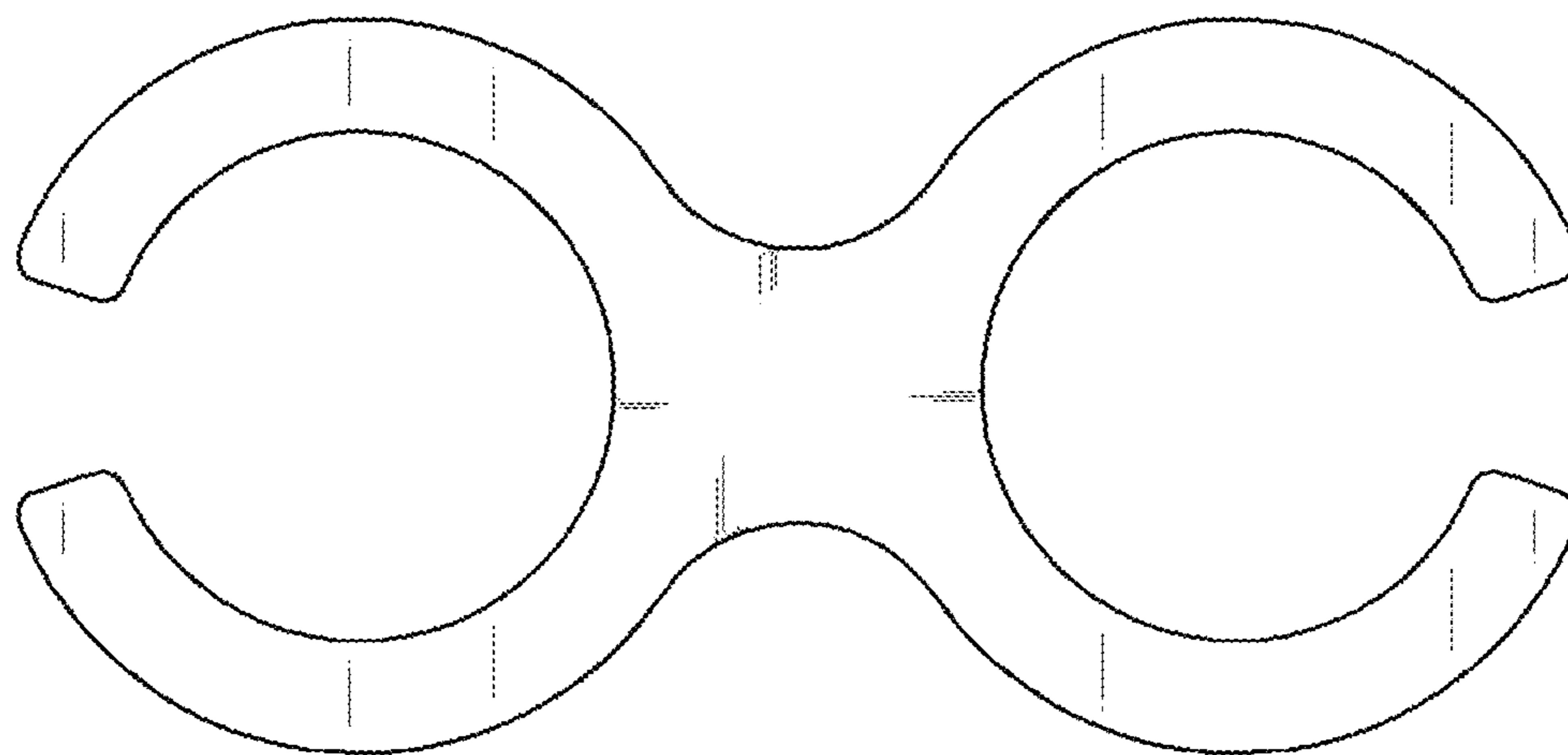

FIG. 24

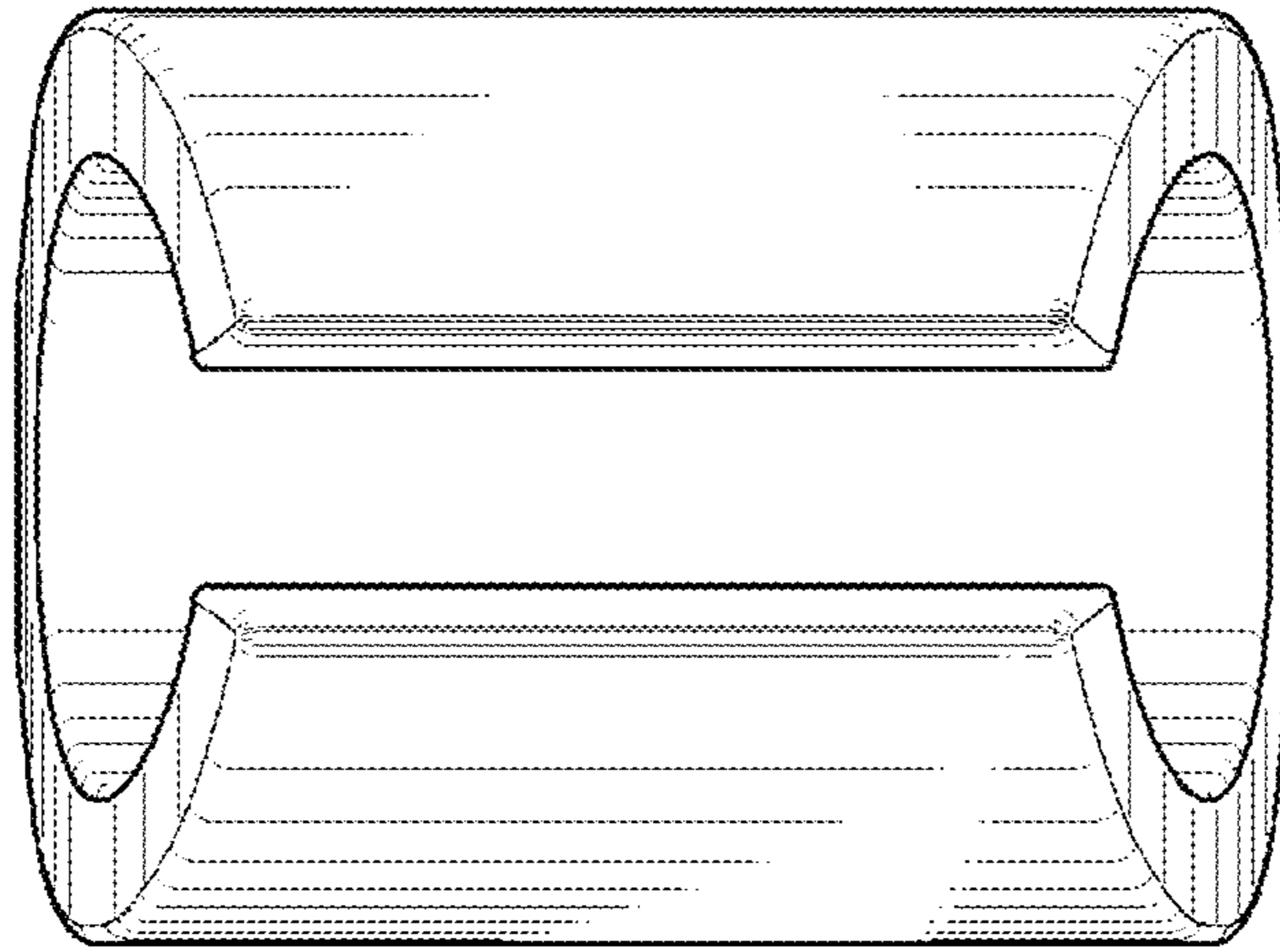

FIG. 25

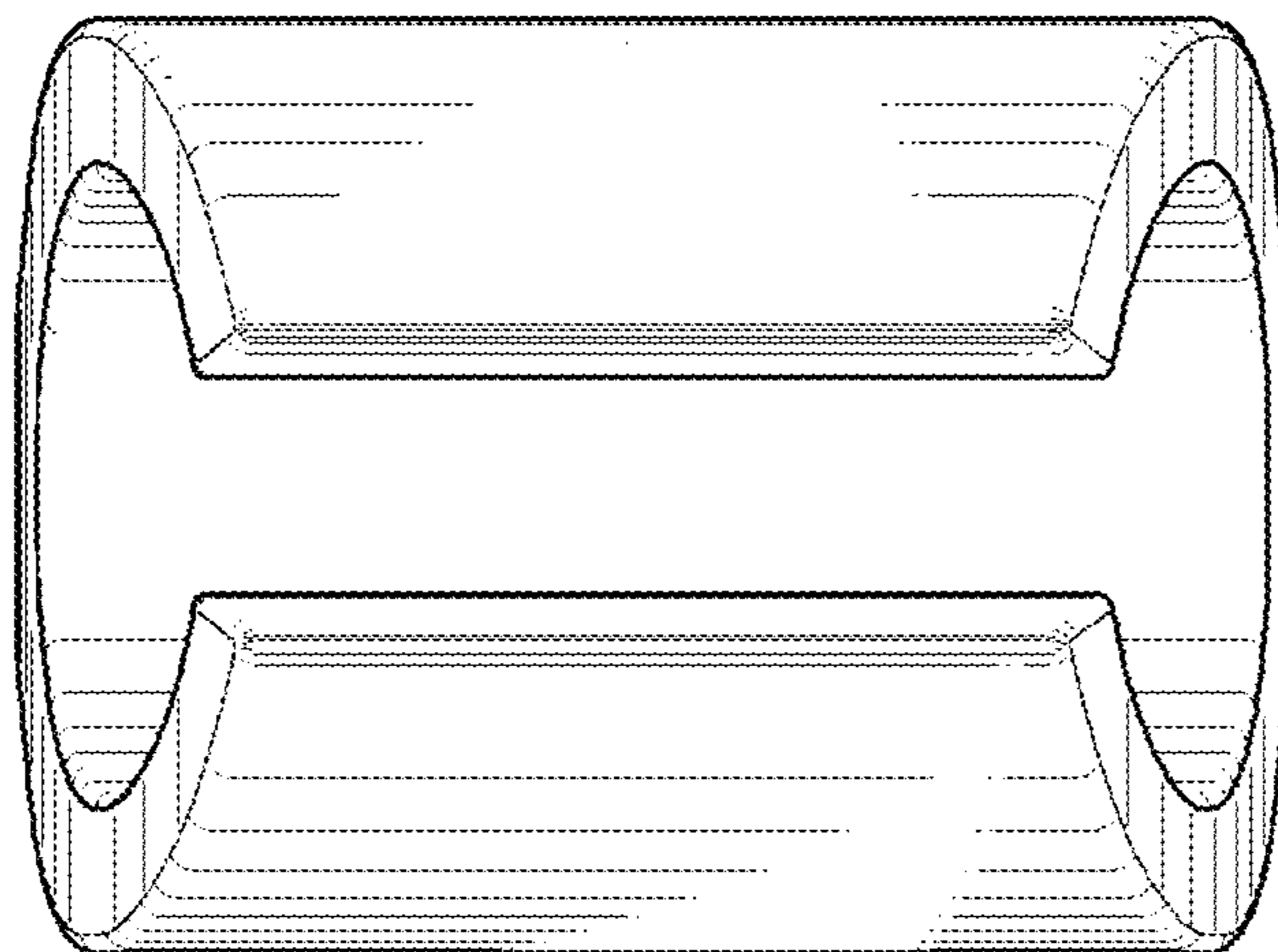

FIG. 26

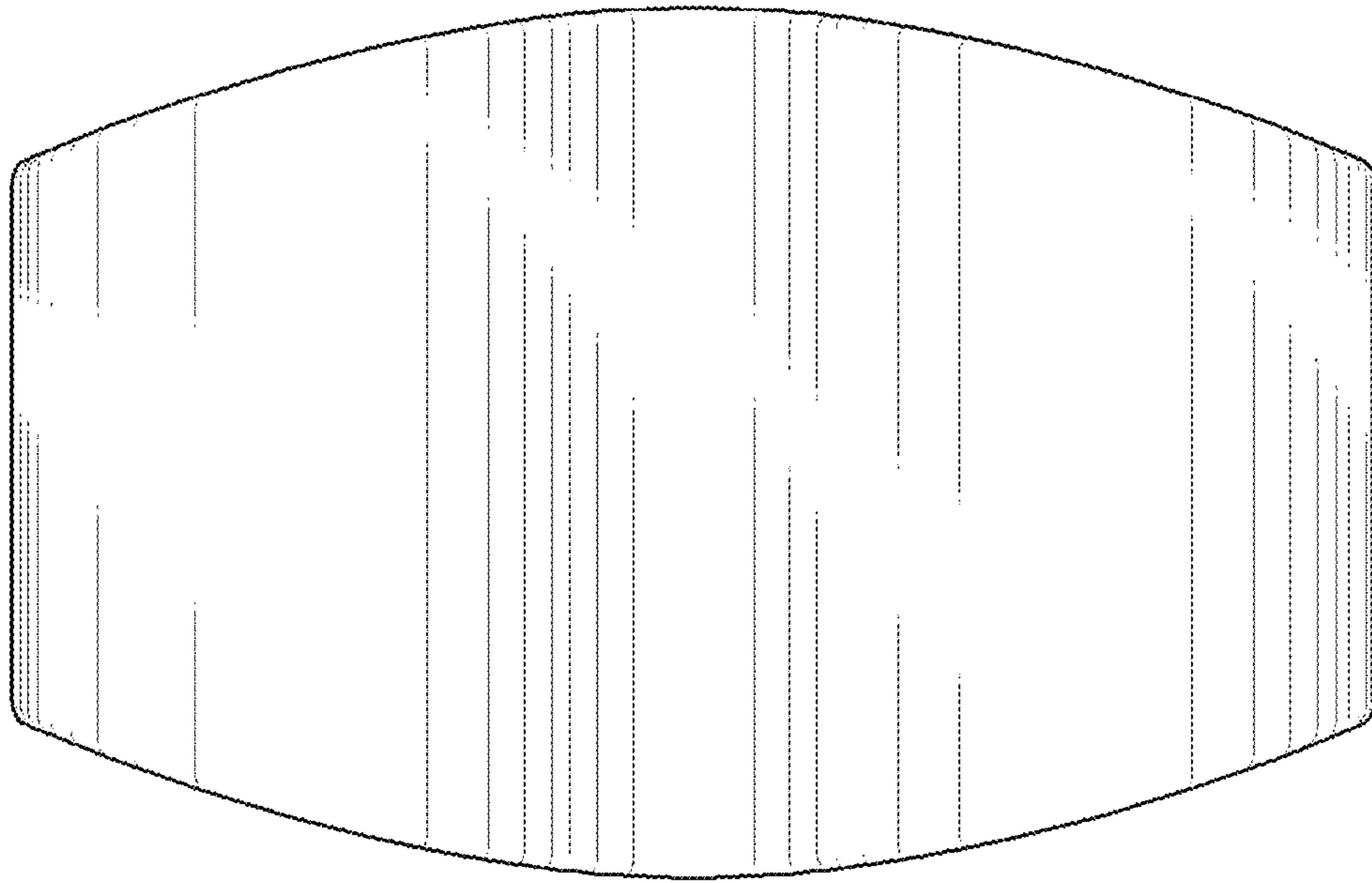

FIG. 27

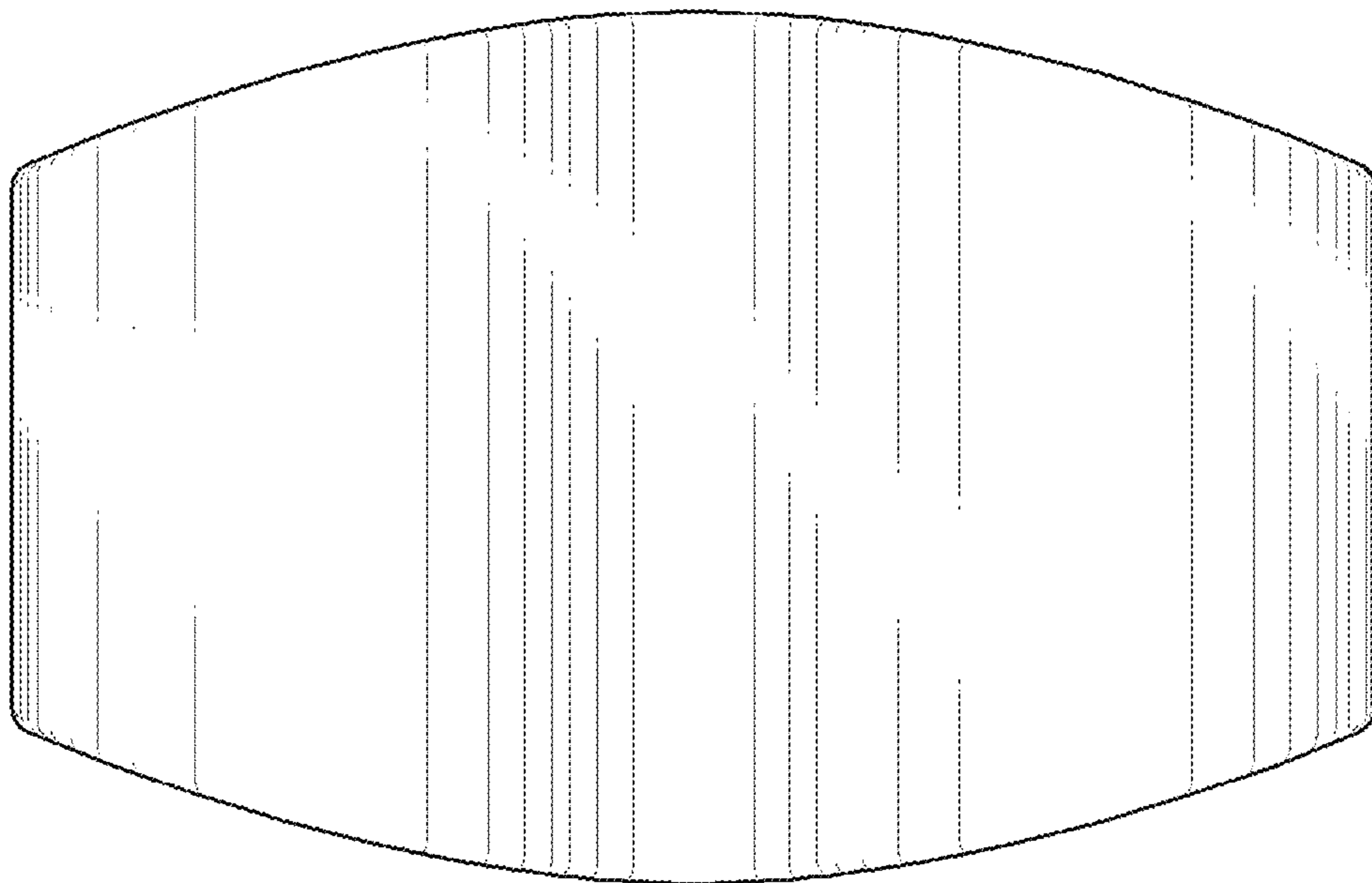

FIG. 28