



US00D763359S

(12) **United States Design Patent**
Kwong

(10) **Patent No.:** **US D763,359 S**

(45) **Date of Patent:** **** Aug. 9, 2016**

(54) **GAME CONTROLLER**

(71) Applicant: **VTech Electronics, Ltd.**, Tai Po (HK)

(72) Inventor: **Chin Fai Kwong**, Tuen Mun (HK)

(73) Assignee: **VTECH ELECTRONICS, LTD.**, Tai Po (HK)

(**) Term: **15 Years**

(21) Appl. No.: **29/528,598**

(22) Filed: **May 29, 2015**

(51) **LOC (10) Cl.** **21-01**

(52) **U.S. Cl.**
USPC **D21/333**; D14/401; D14/412

(58) **Field of Classification Search**
USPC D14/399-401, 412-418; 273/148 B;
463/1, 29-39, 46, 47; 345/156-161,
345/905; D21/333, 328
CPC A63F 13/02; A63F 9/24; A63F 13/12;
A63F 9/00; A63F 11/00; A63F 71/00; G06F
3/02; G06F 3/033; G09G 5/00
See application file for complete search history.

(56) **References Cited**

U.S. PATENT DOCUMENTS

D380,207 S * 6/1997 Wang D14/218
5,643,087 A * 7/1997 Marcus A63F 13/06
273/148 B
5,785,317 A * 7/1998 Sasaki A63F 13/06
273/148 B
D428,012 S * 7/2000 Cavacuiti D14/413

D441,760 S * 5/2001 Hibino D14/415
D638,841 S * 5/2011 Musick, Jr. D14/412
D658,184 S * 4/2012 Chang D14/413
D688,313 S * 8/2013 Brunner D14/400
8,523,675 B2 * 9/2013 Young A63F 13/06
273/148 B
D728,571 S * 5/2015 Perris D14/399
9,081,426 B2 * 7/2015 Armstrong A63F 13/06
D735,722 S * 8/2015 Amann D14/413
D740,369 S * 10/2015 Cho D21/333

* cited by examiner

Primary Examiner — Prabhakar Deshmukh

(74) *Attorney, Agent, or Firm* — McAndrews, Held & Malloy, Ltd.

(57) **CLAIM**

The ornamental design for a game controller, as shown and described.

DESCRIPTION

FIG. 1 is a top front perspective view of a game controller showing my new design;
FIG. 2 is a front view thereof;
FIG. 3 is a rear view thereof;
FIG. 4 is a right-side elevation view thereof;
FIG. 5 is a left-side elevation view thereof;
FIG. 6 is a top plan view thereof;
FIG. 7 is a bottom plan view thereof;
FIG. 8 is a top rear perspective view thereof;
FIG. 9 is a bottom front perspective view thereof; and,
FIG. 10 is a bottom rear perspective view thereof.

1 Claim, 8 Drawing Sheets

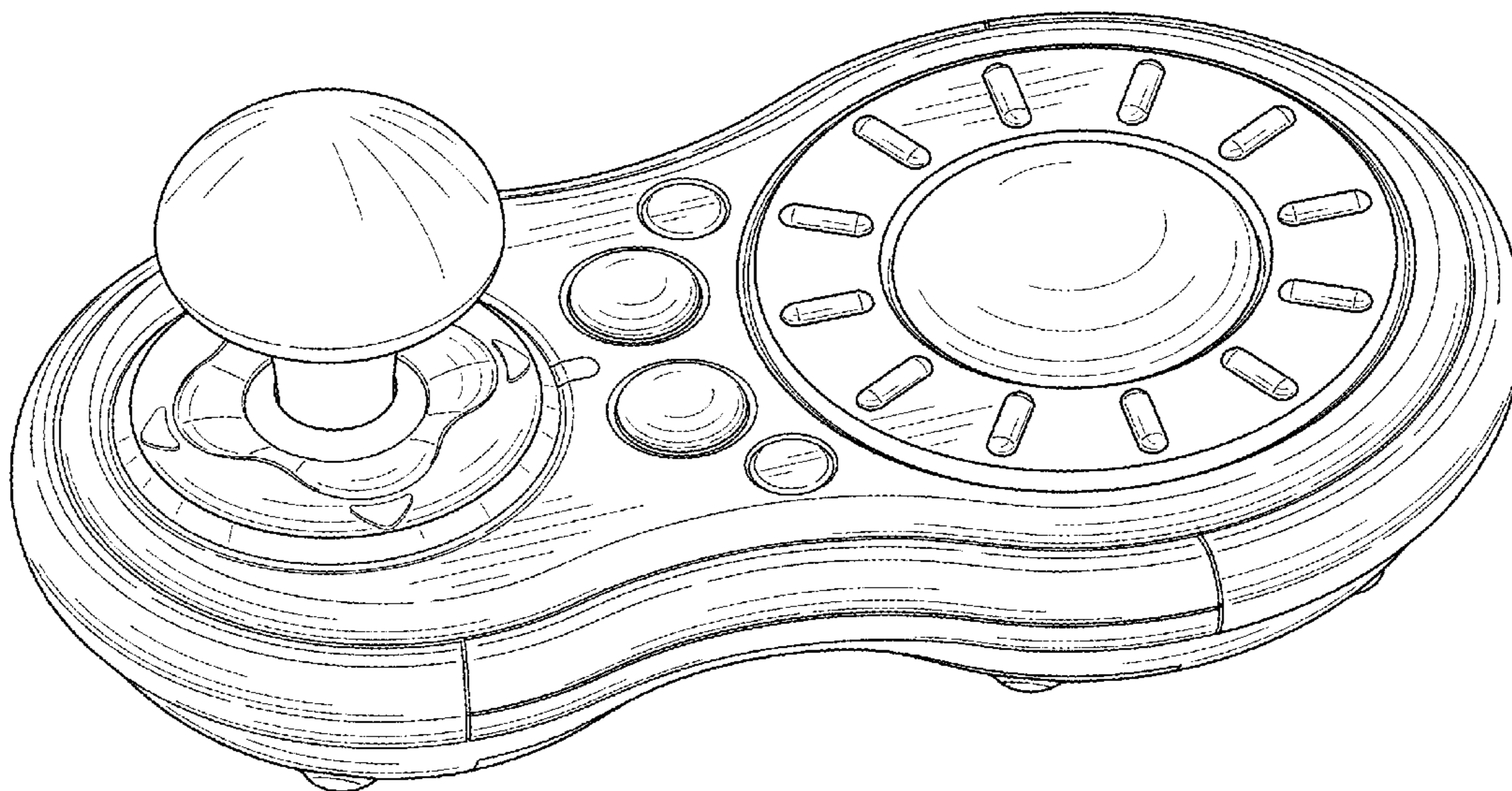

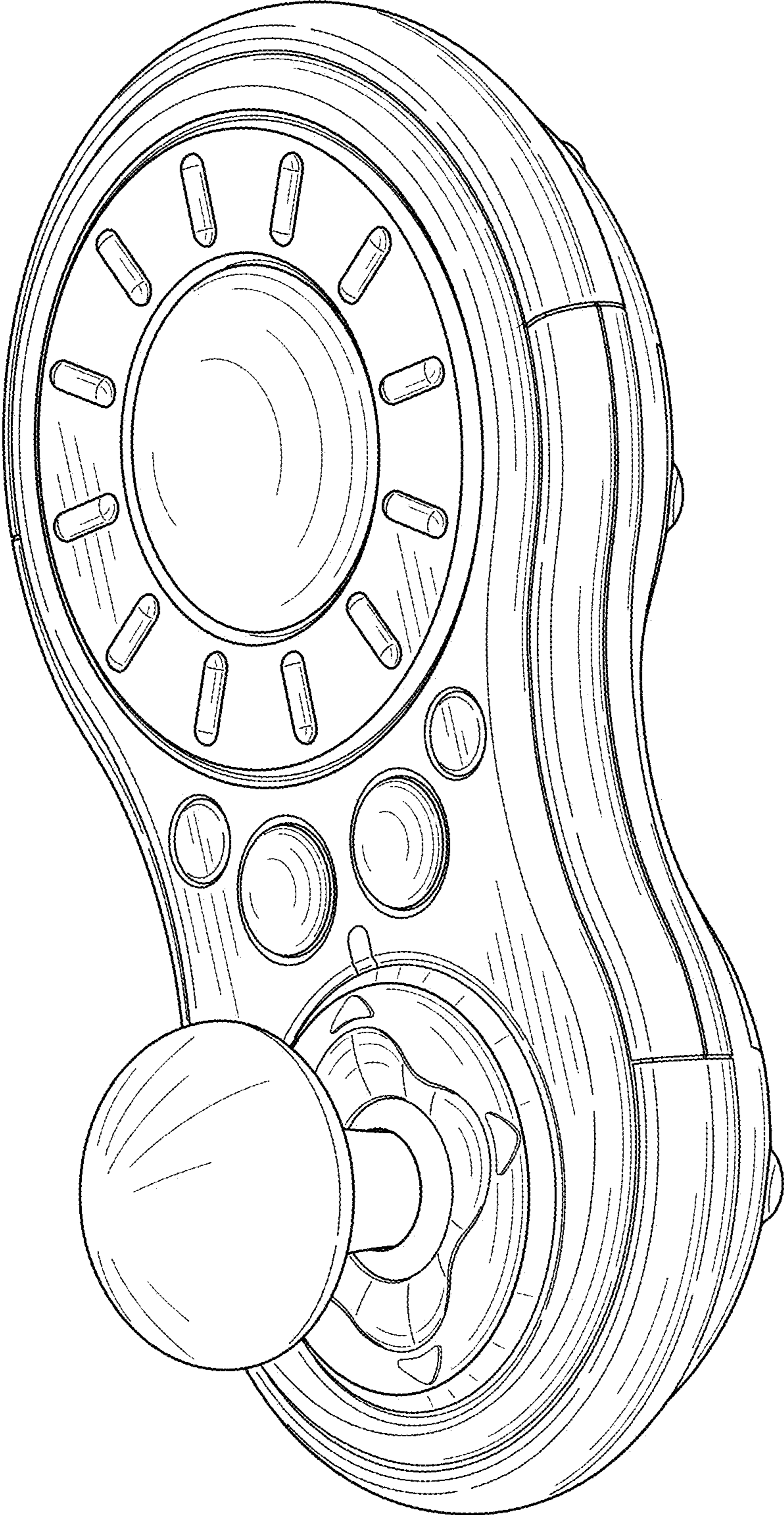

FIG. 1

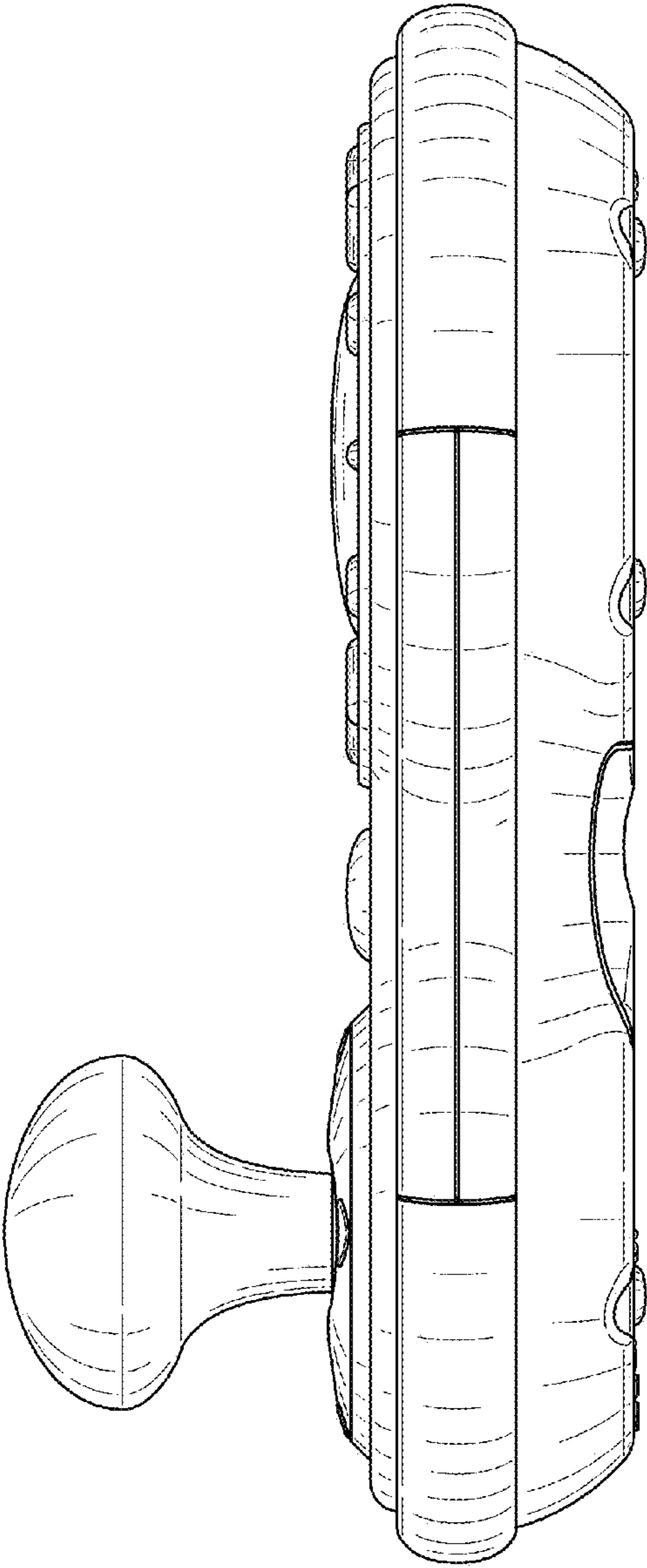

FIG. 2

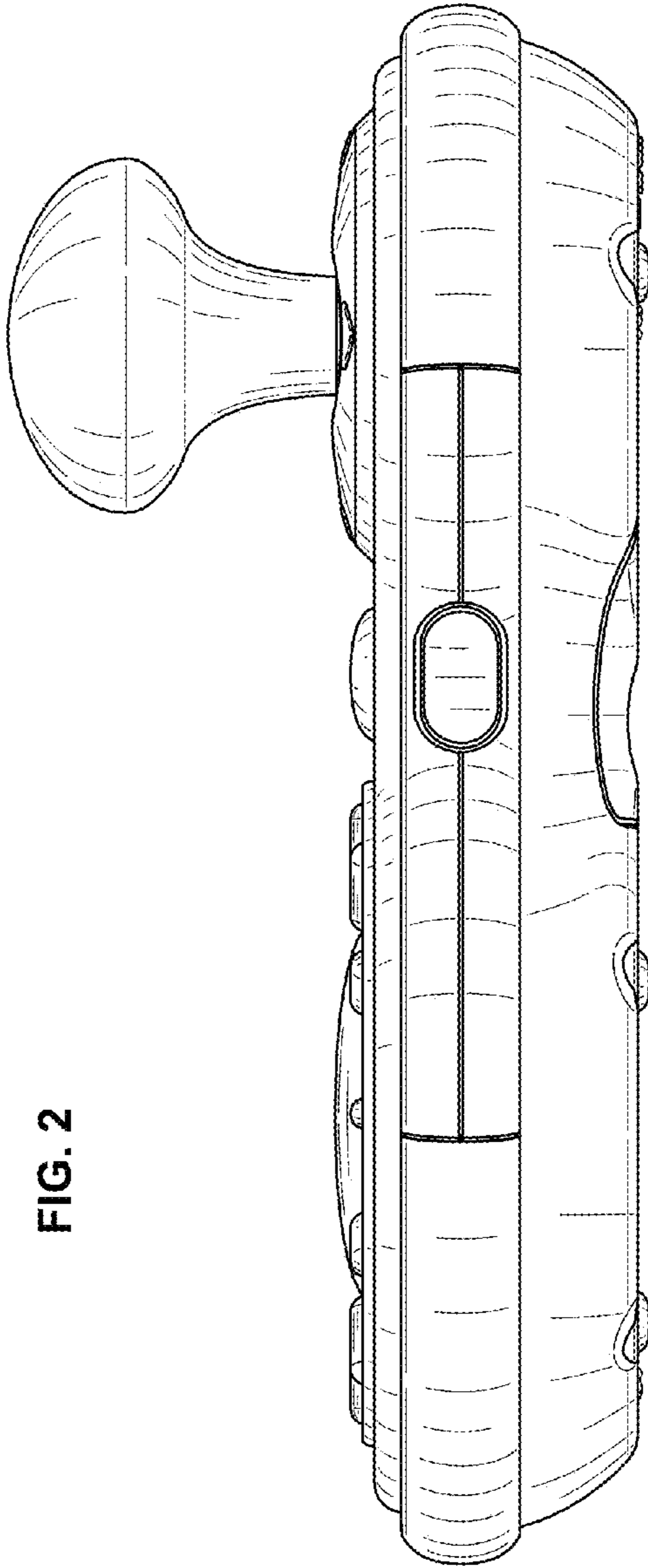

FIG. 3

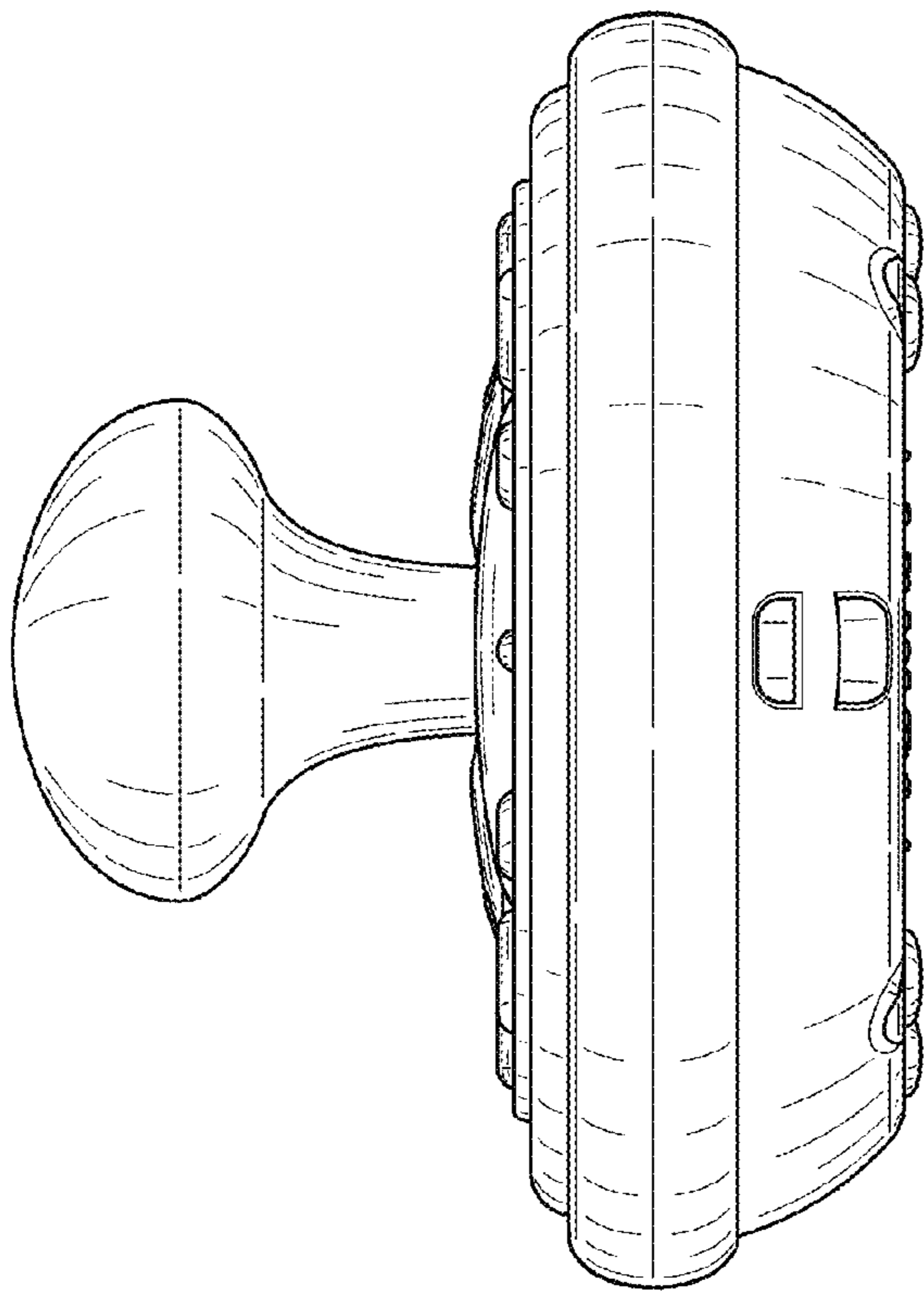

FIG. 4

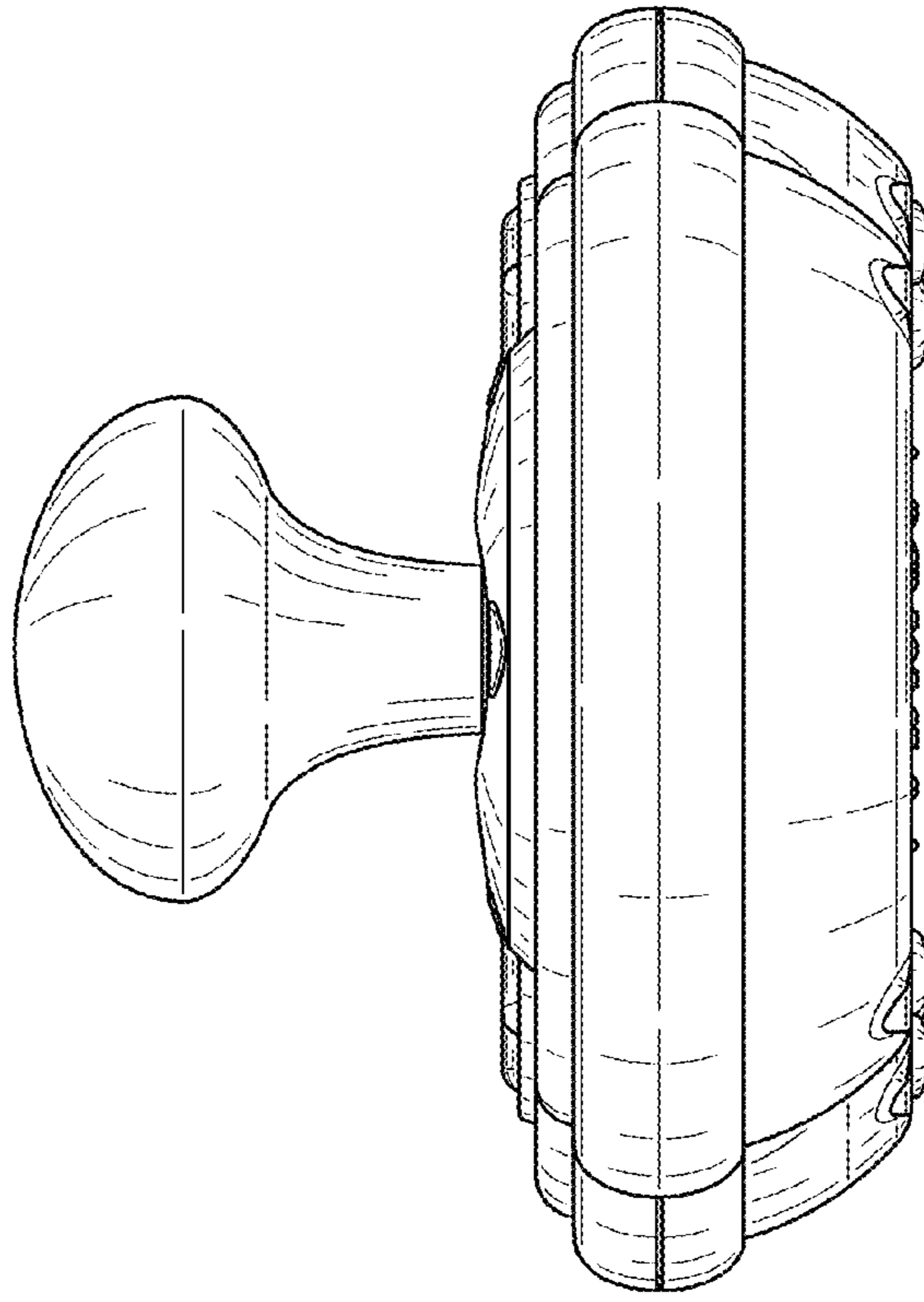

FIG. 5

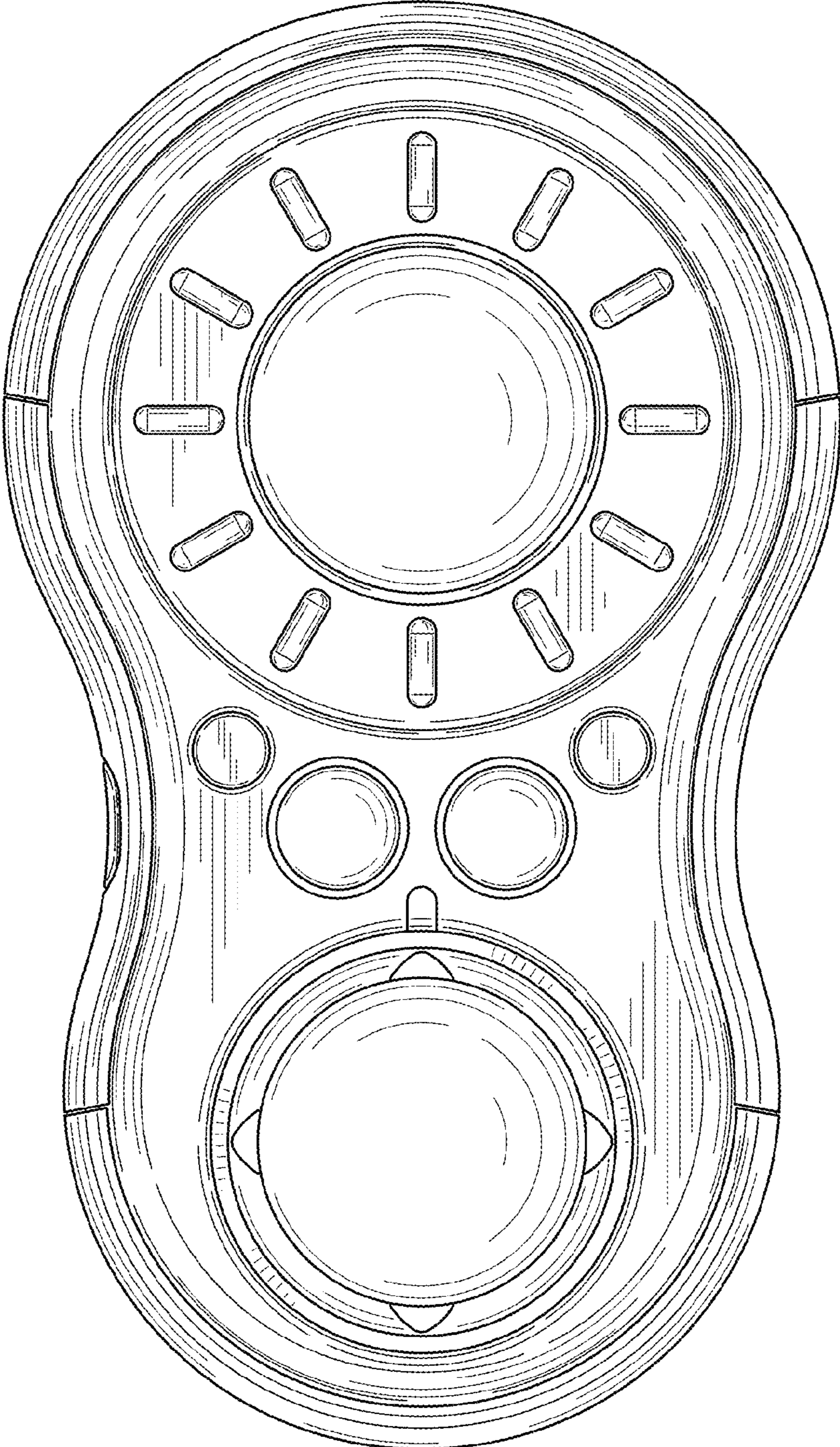

FIG. 6

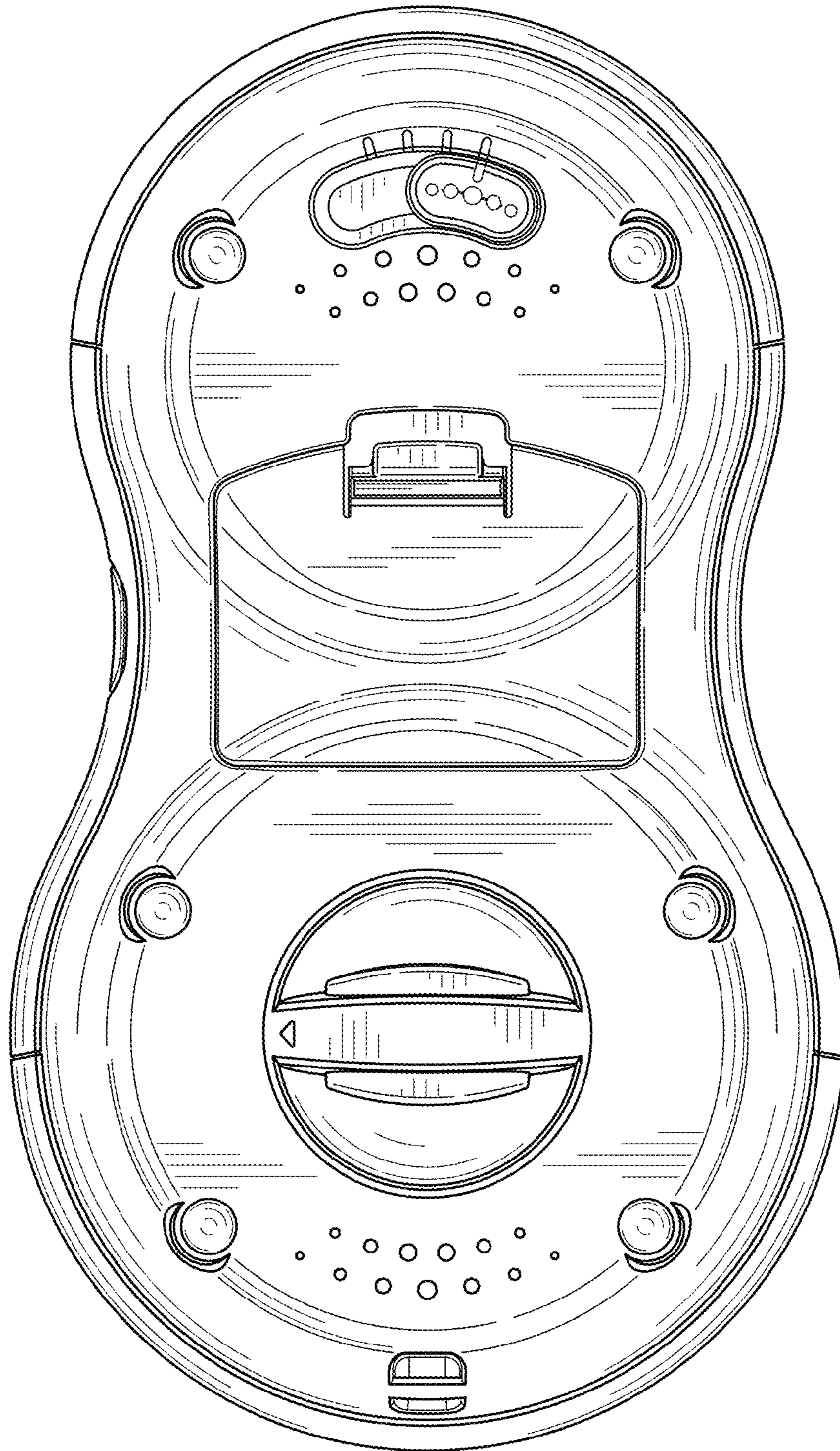

FIG. 7

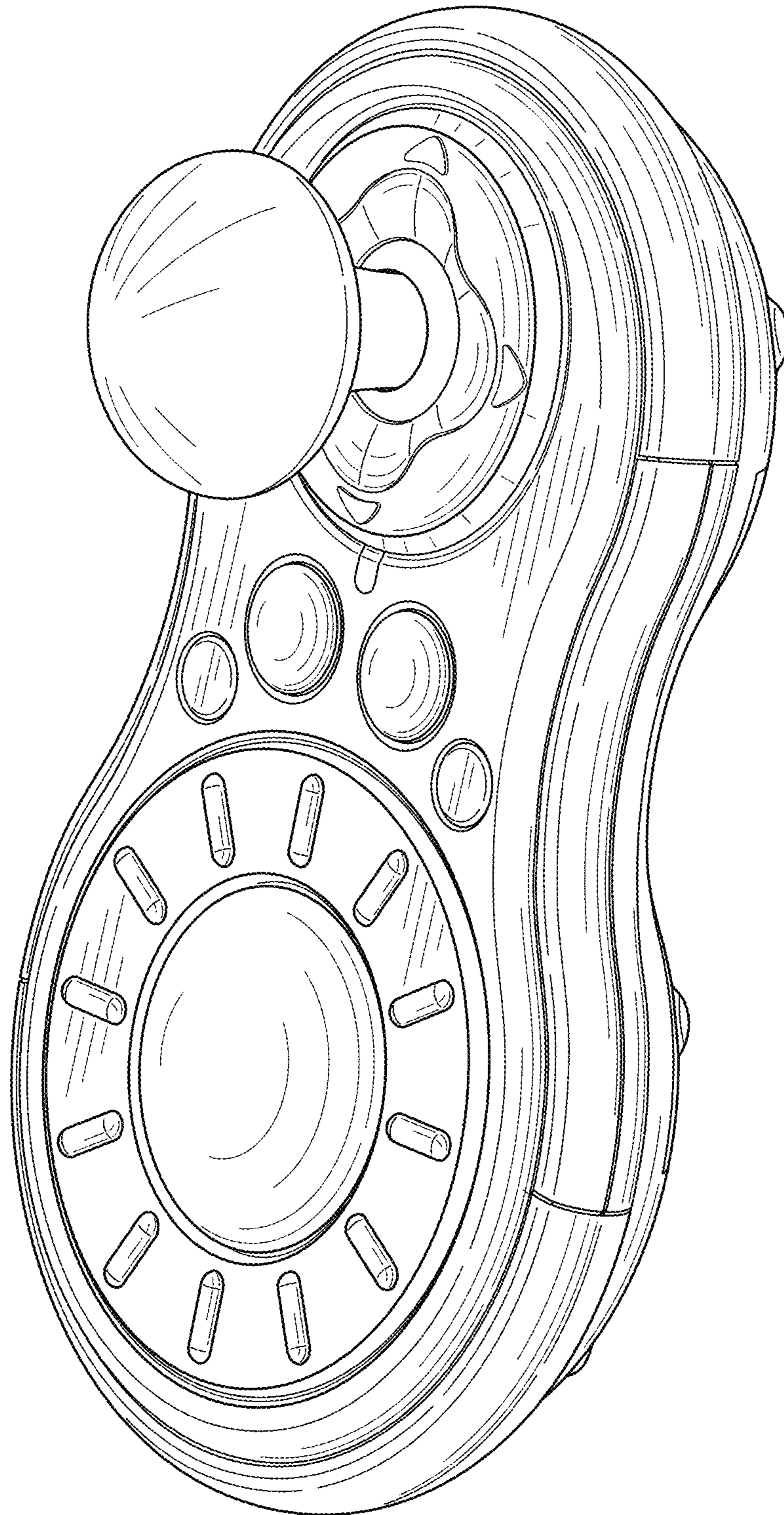

FIG. 8

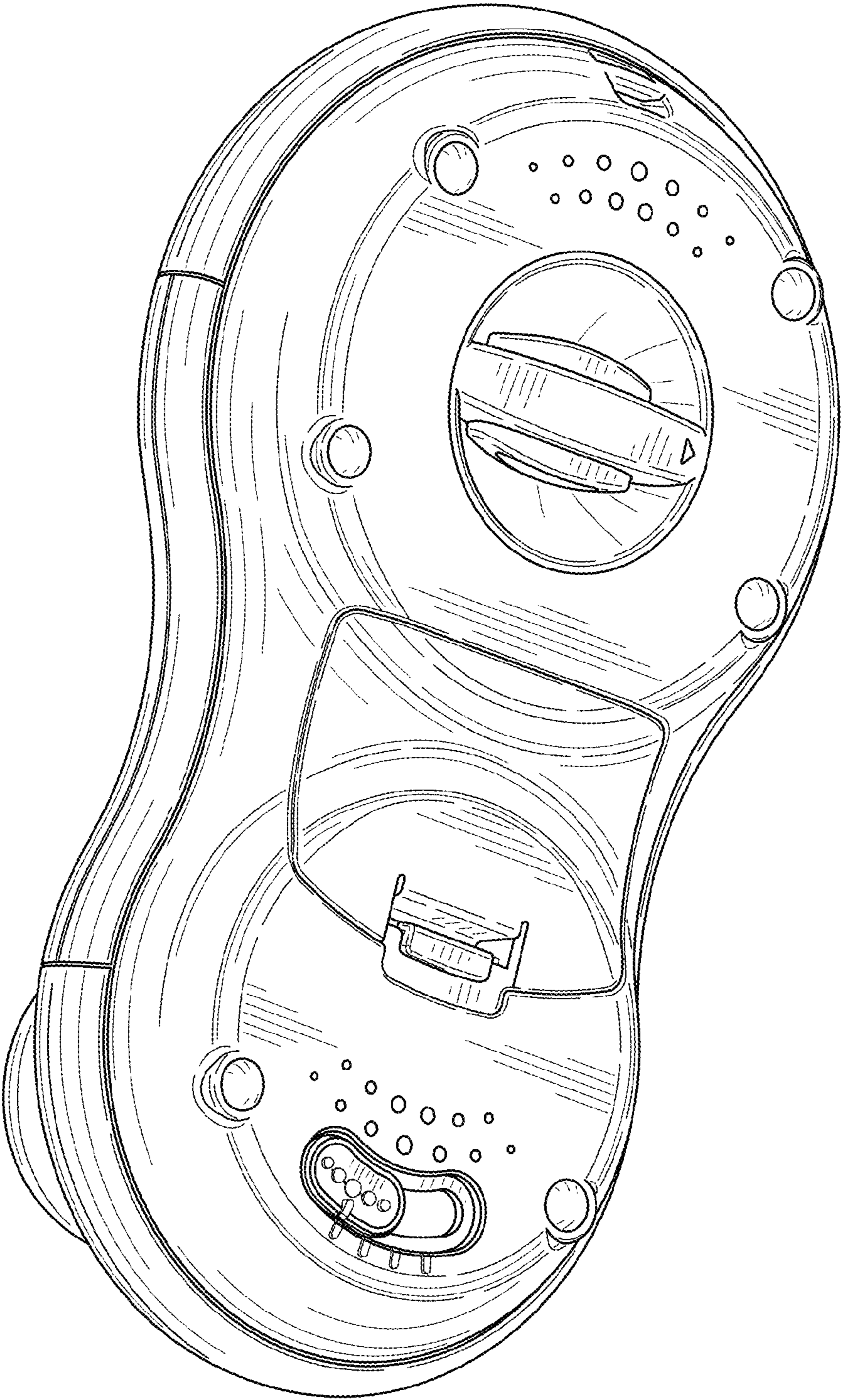

FIG. 9

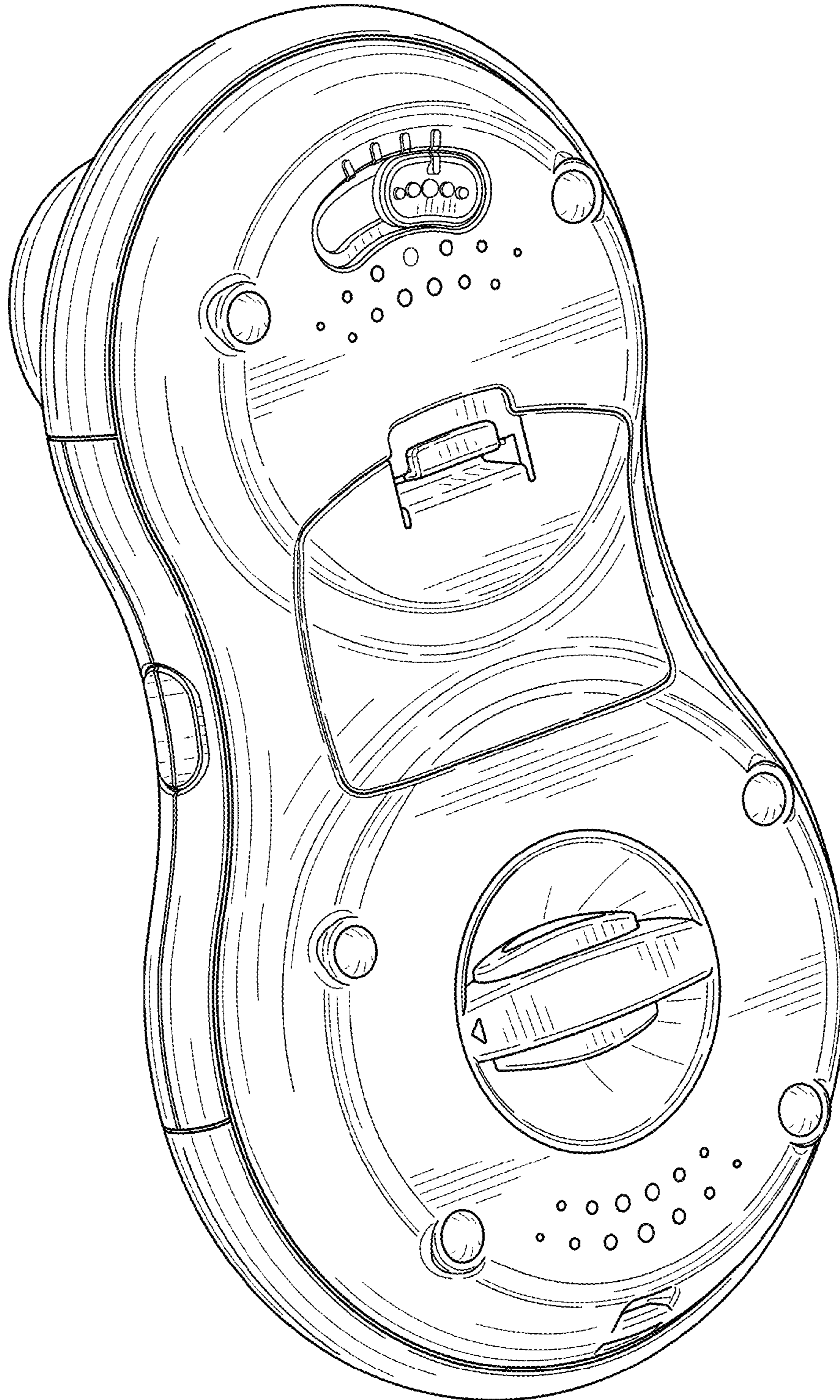

FIG. 10