



US00D763260S

(12) **United States Design Patent**  
**Wade et al.**

(10) **Patent No.:** **US D763,260 S**

(45) **Date of Patent:** **\*\* Aug. 9, 2016**

(54) **STYLUS**

*Primary Examiner* — Austin Murphy

(71) Applicants: **Lucas Wade**, Austin, TX (US); **Bastian Albinus**, Taipei (TW); **Willy Fan**, Taipei (TW); **Eugene Hung**, Taipei (TW)

(57) **CLAIM**  
The ornamental design for a stylus, as shown and described.

(72) Inventors: **Lucas Wade**, Austin, TX (US); **Bastian Albinus**, Taipei (TW); **Willy Fan**, Taipei (TW); **Eugene Hung**, Taipei (TW)

**DESCRIPTION**

(\*\*) Term: **14 Years**

(21) Appl. No.: **29/524,745**

(22) Filed: **Apr. 23, 2015**

(51) **LOC (10) Cl.** ..... **14-02**

(52) **U.S. Cl.**  
USPC ..... **D14/411**

(58) **Field of Classification Search**  
USPC ..... D14/411; D19/35, 36, 41–51, 54–58;  
401/55, 99, 100, 104–107, 196, 197,  
401/202, 208, 209, 213, 192, 195, 243;  
708/107; 345/179, 173; 178/19.01;  
700/94

CPC ..... G06F 3/016; G06F 3/033; G06F 3/0317;  
G06F 3/03545; G06F 3/041; G06K 9/222  
See application file for complete search history.

FIG. 1 is a perspective view from the lower right front of the stylus, with detachable cap screwed onto the top;  
FIG. 2 is a front view thereof;  
FIG. 3 is a left side view thereof;  
FIG. 4 is a right side view thereof;  
FIG. 5 is a rear view thereof;  
FIG. 6 is a top view thereof;  
FIG. 7 is a bottom view thereof;  
FIG. 8 is a perspective view from the upper left rear thereof, shown in use in a typical environment;  
FIG. 9 is a perspective view from the lower right front of the stylus, with detachable cap removed entirely;  
FIG. 10 is a front view thereof;  
FIG. 11 is a left side view thereof;  
FIG. 12 is a right side view thereof;  
FIG. 13 is a rear view thereof;  
FIG. 14 is a top view thereof;  
FIG. 15 is a bottom view thereof;  
FIG. 16 is a perspective view from the upper left rear thereof, shown in use in a typical environment;  
FIG. 17 is a perspective view from the lower right front of the stylus, with detachable cap screwed onto the bottom of the stylus;  
FIG. 18 is a front view thereof;  
FIG. 19 is a left side view thereof;  
FIG. 20 is a right side view thereof;  
FIG. 21 is a rear view thereof;  
FIG. 22 is a top view thereof; and,  
FIG. 23 is a bottom view thereof.  
The broken lines shown in the drawings illustrate unclaimed portions of the design and/or environmental structure and form no part of the claimed design.

(56) **References Cited**

U.S. PATENT DOCUMENTS

D623,650 S	*	9/2010	Ishibashi	.....	D14/411
D634,747 S	*	3/2011	Wong	.....	D14/411
D686,618 S	*	7/2013	Wilson	.....	D14/411
D686,620 S	*	7/2013	Chung	.....	D14/411
D710,854 S	*	8/2014	Huang	.....	D14/411
D715,297 S	*	10/2014	Li	.....	D14/411
D717,798 S	*	11/2014	Groene	.....	D14/411
D718,312 S	*	11/2014	Boisdevesys	.....	D14/411
D720,348 S	*	12/2014	Robinson	.....	D14/411
D724,087 S	*	3/2015	Sakatsume	.....	D14/411
D725,112 S	*	3/2015	Bo	.....	D14/411
D743,396 S	*	11/2015	Wade	.....	D14/411

\* cited by examiner

**1 Claim, 8 Drawing Sheets**

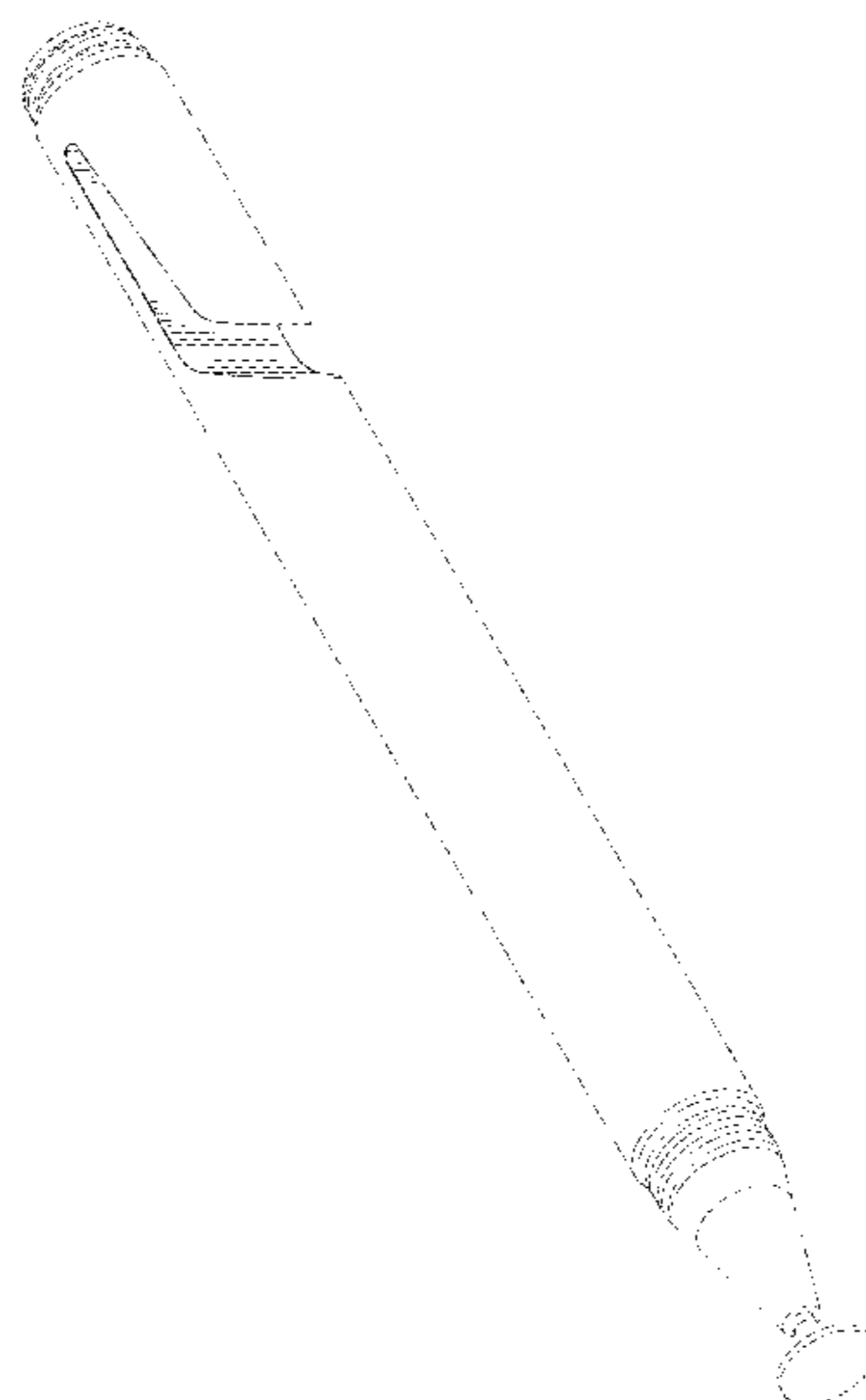

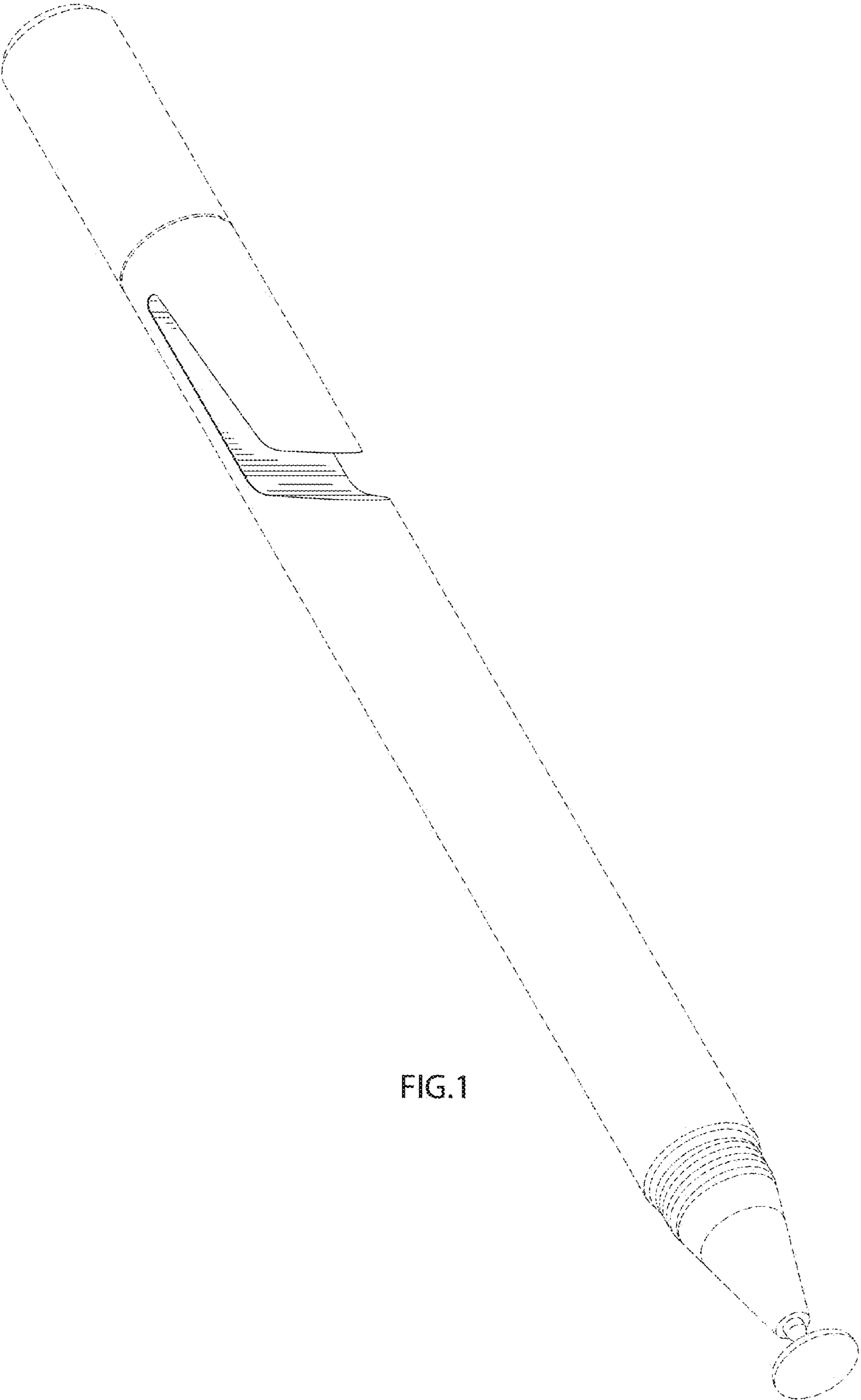

FIG.1

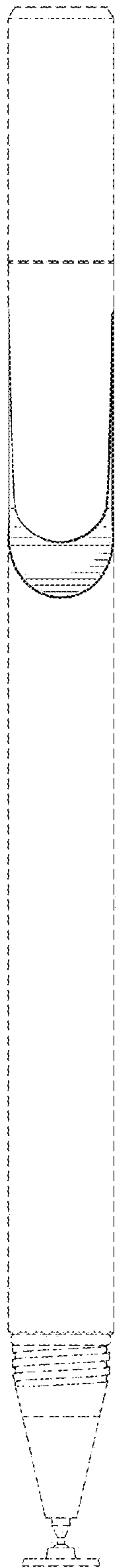

FIG. 2

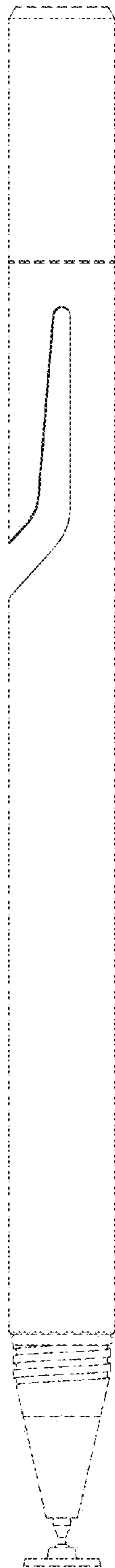

FIG. 3

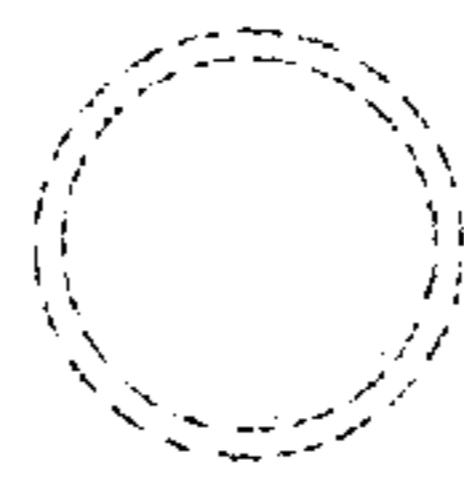

FIG. 6

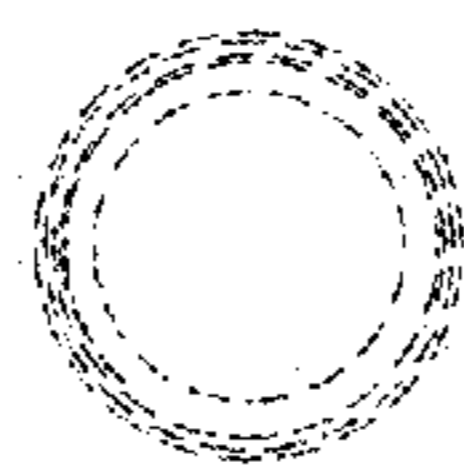

FIG. 7

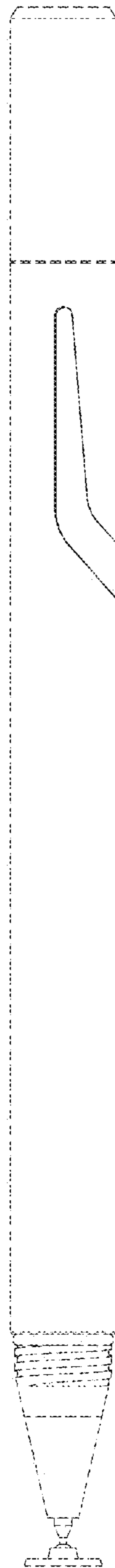

FIG. 4

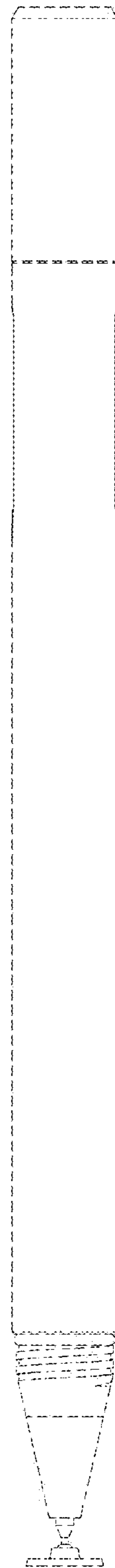

FIG. 5

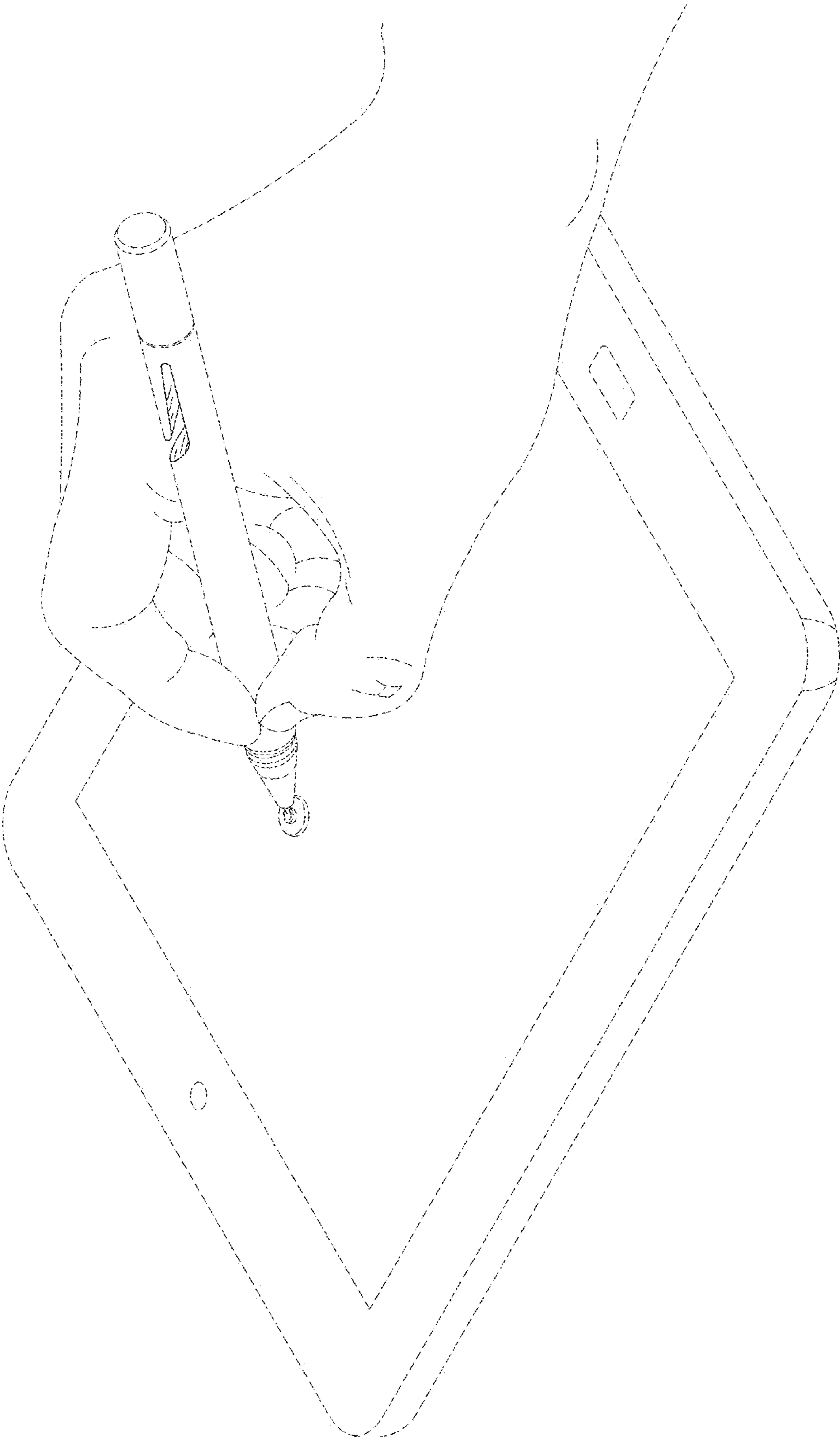

FIG.8

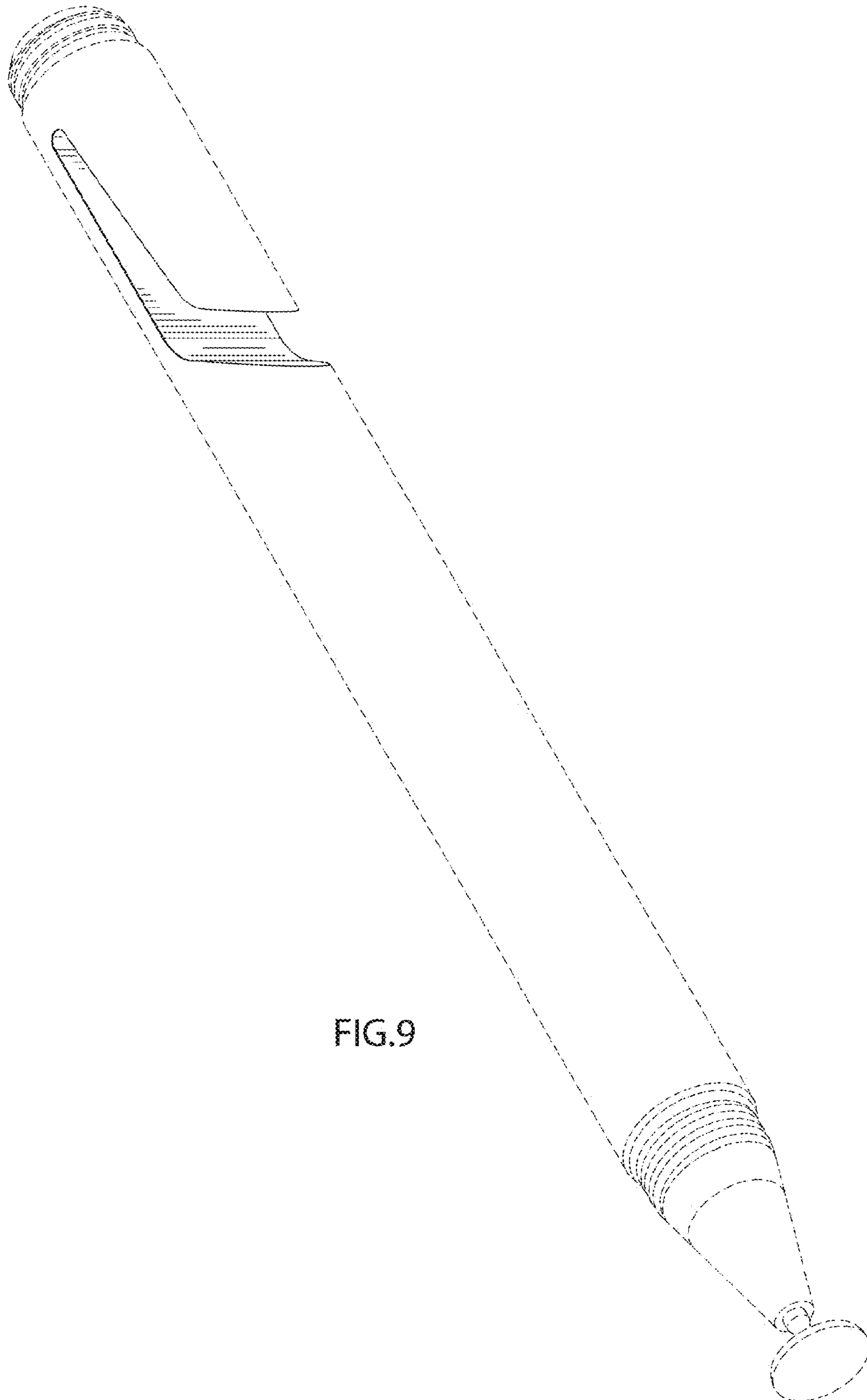

FIG.9

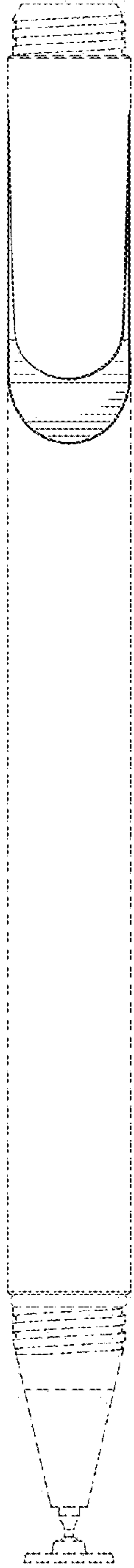

FIG. 10

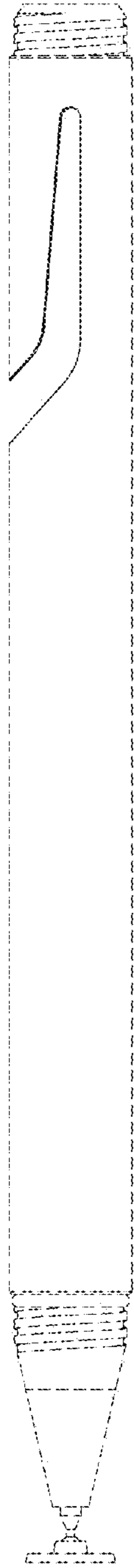

FIG. 11

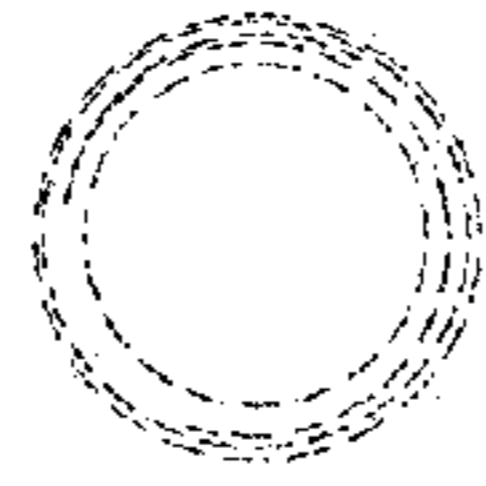

FIG. 14

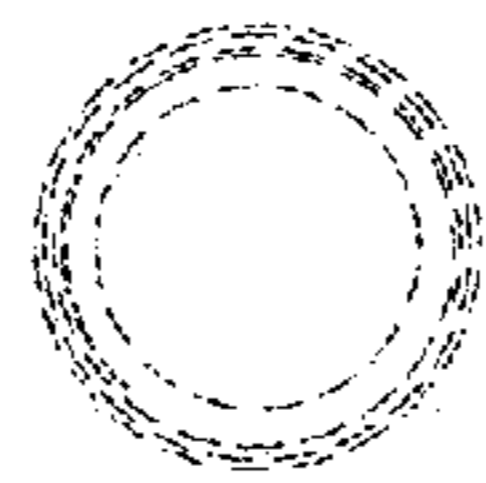

FIG. 15

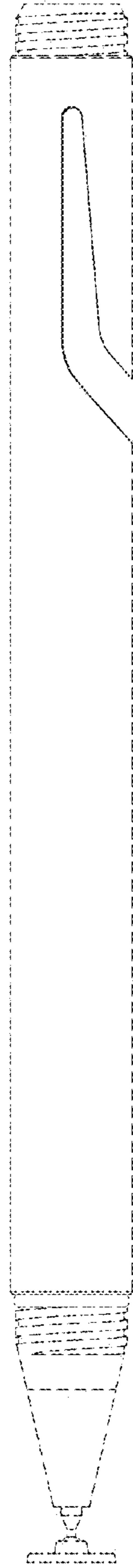

FIG. 12

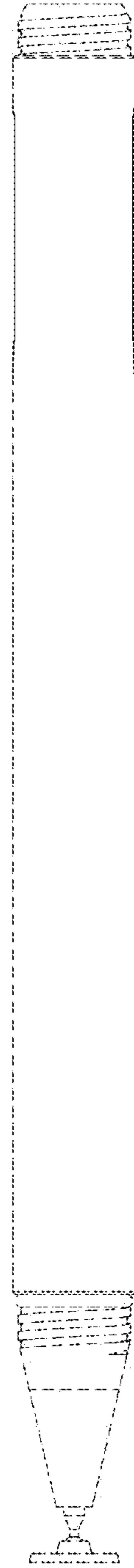

FIG. 13



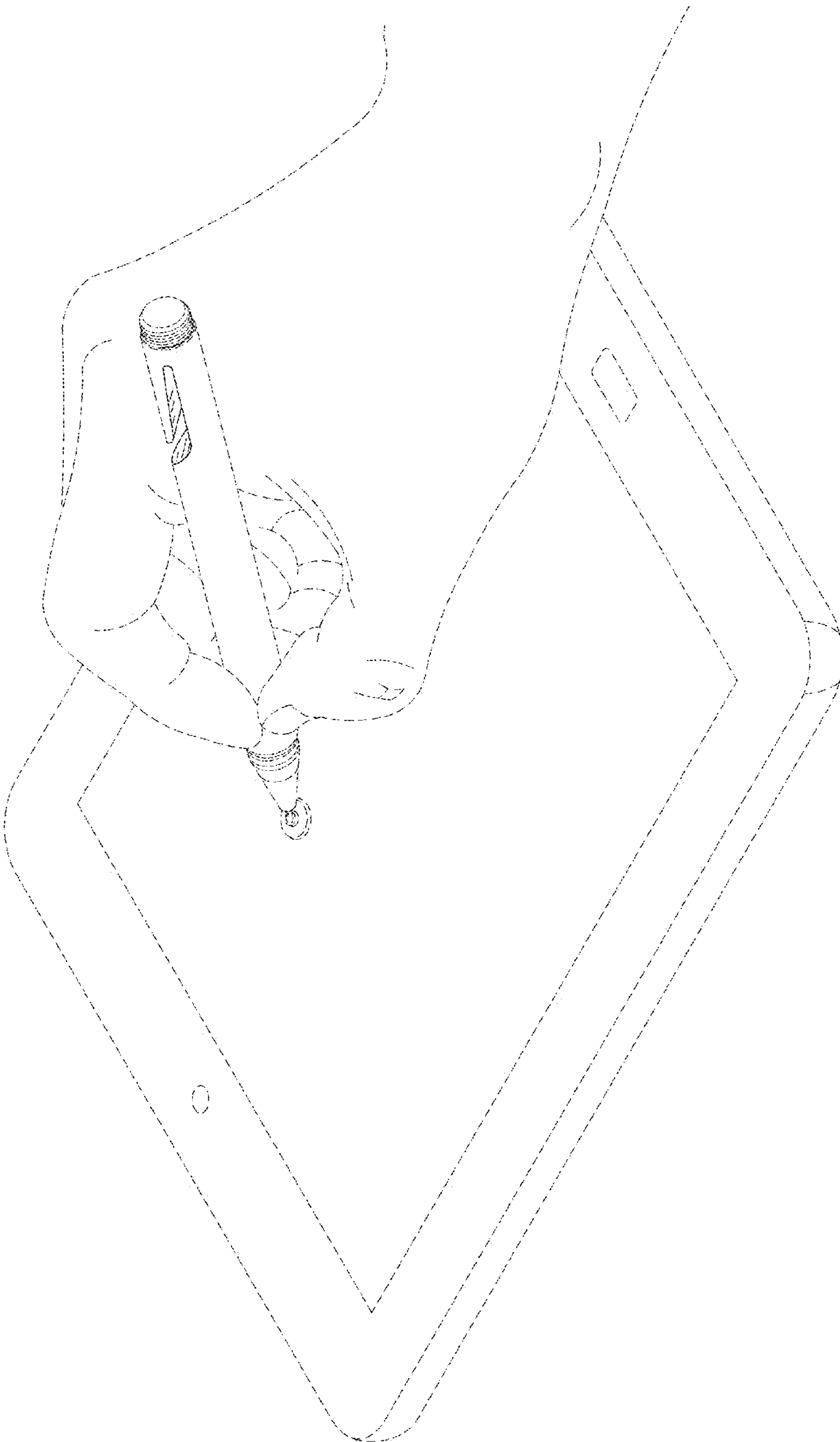

FIG.16

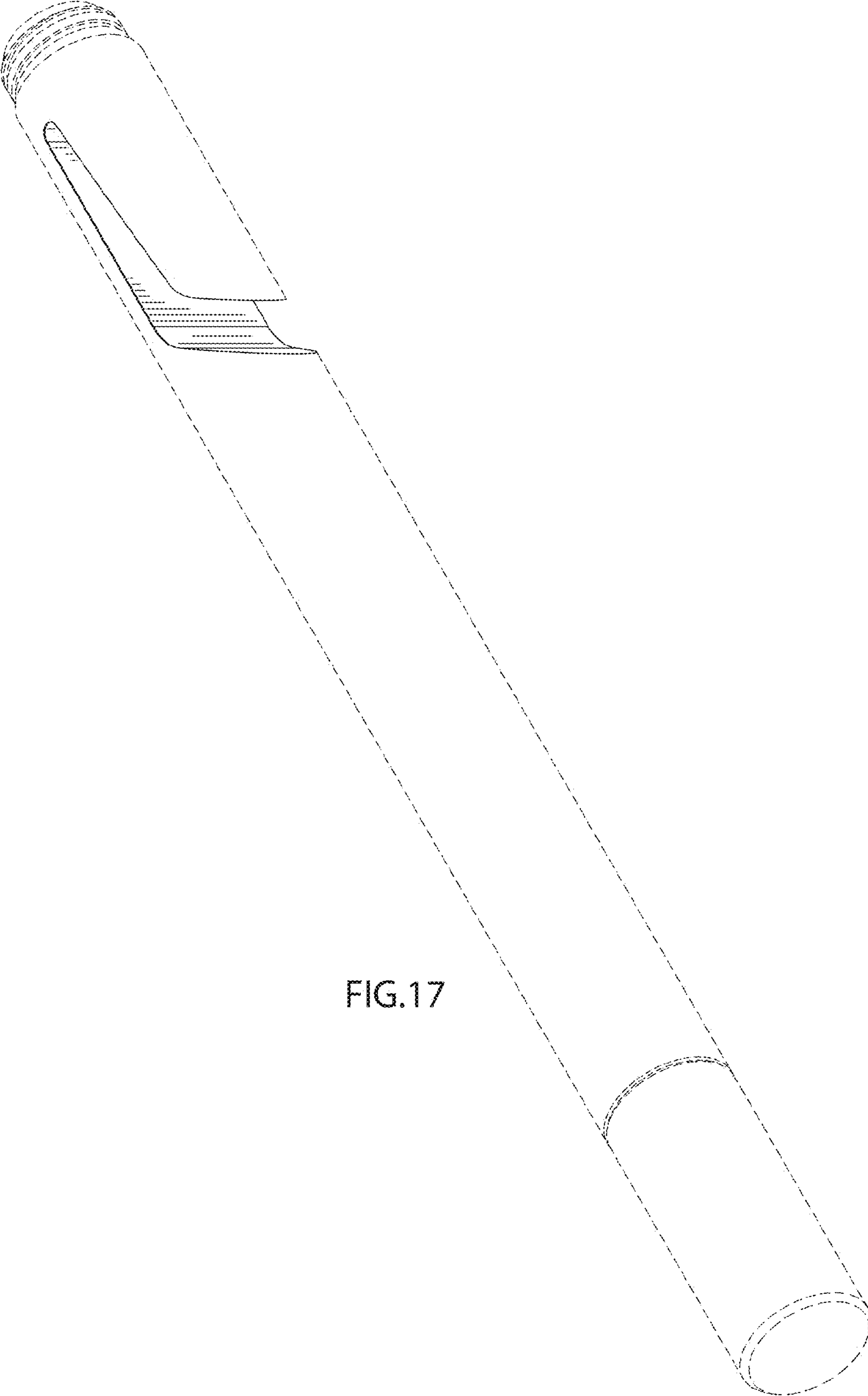

FIG.17



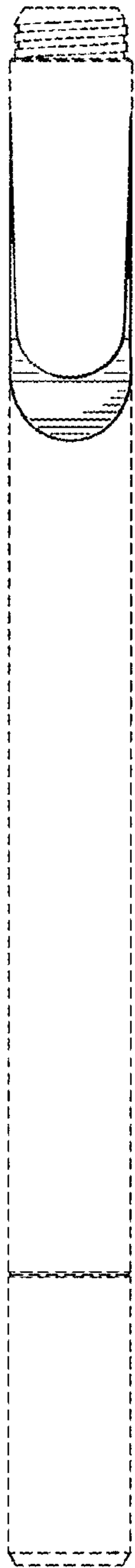

FIG.18

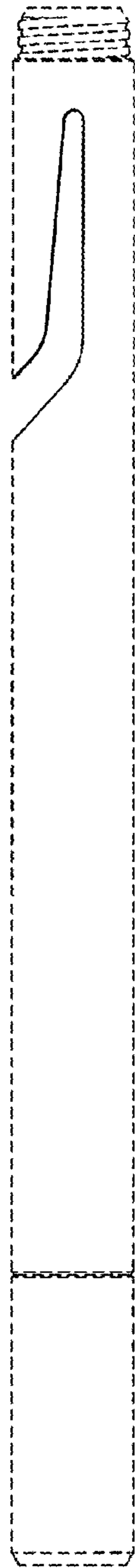

FIG.19

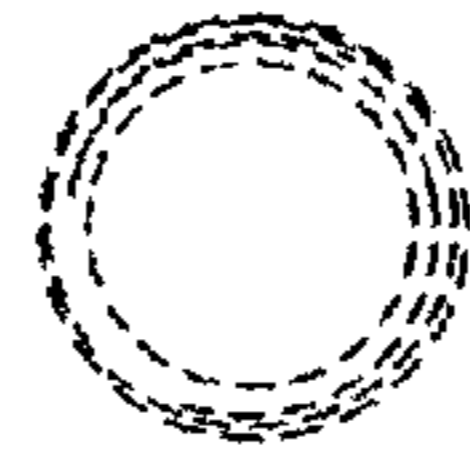

FIG.22

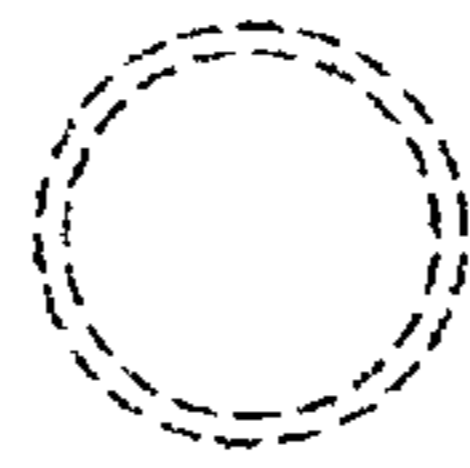

FIG.23

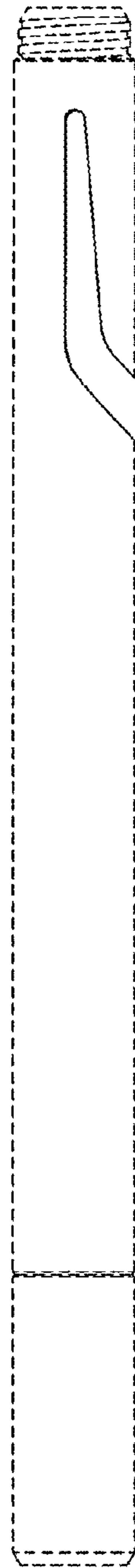

FIG.20

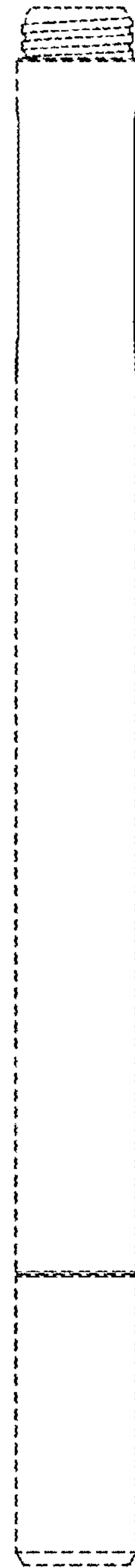

FIG.21