



US00D763201S

(12) **United States Design Patent**  
**Burkell et al.**

(10) **Patent No.:** **US D763,201 S**  
(45) **Date of Patent:** **\*\* Aug. 9, 2016**

(54) **SYSTEM CONTROLLER ENCLOSURE**

(71) Applicant: **General Electric Company**,  
Schenectady, NY (US)  
(72) Inventors: **Neil William Burkell**, Lawrence Park,  
PA (US); **Wing Yeung Chung**, Erie, PA  
(US); **Neil Patrick Bradley**, Lawrence  
Park, PA (US); **Michael Kjelson**, Erie,  
PA (US); **Ronald Majewski**, Lawrence  
Park, PA (US)  
(73) Assignee: **General Electric Company**,  
Schenectady, NY (US)

(\*\*) Term: **14 Years**  
(21) Appl. No.: **29/500,900**  
(22) Filed: **Aug. 29, 2014**  
(51) **LOC (10) Cl.** ..... **13-03**  
(52) **U.S. Cl.**  
USPC ..... **D13/162**  
(58) **Field of Classification Search**  
USPC ..... D13/147, 162, 162.1, 164; 307/147;  
361/735  
CPC .. G06F 13/00; H01R 9/14695; H01R 13/514;  
H05K 5/00; H05K 5/0026; H05K 5/03;  
H05K 7/1462; H05K 7/1472  
See application file for complete search history.

(56) **References Cited**

**U.S. PATENT DOCUMENTS**

D319,425 S \* 8/1991 Bibbiani ..... D13/123  
D355,887 S \* 2/1995 Rodeffer ..... D13/110  
D425,483 S \* 5/2000 Bechtold ..... D13/147  
D443,586 S \* 6/2001 Sakasegawa ..... D13/123  
6,527,599 B2 \* 3/2003 Bechtold ..... H01R 27/02  
439/209  
6,634,910 B2 \* 10/2003 Lieb ..... H05K 7/1465  
439/271  
6,802,737 B2 \* 10/2004 Bergner ..... H01R 9/2658  
439/532  
D544,836 S \* 6/2007 Sichner ..... D13/123  
7,397,668 B2 \* 7/2008 Sekine ..... H05K 7/1465  
361/728  
D576,562 S \* 9/2008 Kaluza ..... D13/162  
D593,962 S \* 6/2009 Ross ..... D13/123

7,619,898 B2 \* 11/2009 Jensen ..... H05K 5/0021  
361/715  
7,973,562 B1 \* 7/2011 Zhang ..... H03K 19/018507  
307/115  
8,256,456 B2 \* 9/2012 De Carolis ..... F15B 13/0857  
137/560  
D688,212 S \* 8/2013 Scheucher ..... D13/158  
D705,742 S \* 5/2014 Schneider ..... D13/162  
D744,956 S \* 12/2015 Sekine ..... D13/147

**OTHER PUBLICATIONS**

“M-Force SD500 Severe Duty AC Traction Drive System” Brochure,  
Magnetek Mining, Copyright 2014.

\* cited by examiner

*Primary Examiner* — Selina Sikder

(74) *Attorney, Agent, or Firm* — GE Global Patent Operation

(57) **CLAIM**

The ornamental design for a system controller enclosure, as  
shown and described.

**DESCRIPTION**

FIG. 1 is a perspective view of a system controller enclosure  
depicting a first embodiment of a new design;  
FIG. 2 is a front elevational view thereof;  
FIG. 3 is a rear elevational view thereof;  
FIG. 4 is a left side elevational view thereof;  
FIG. 5 is a right side elevational view thereof;  
FIG. 6 is a top plan view thereof; and  
FIG. 7 is a bottom plan view thereof;  
FIG. 8 is a perspective view of a system controller enclosure  
depicting second embodiment of a new design;  
FIG. 9 is a front elevational view thereof;  
FIG. 10 is a rear elevational view thereof;  
FIG. 11 is a left side elevational view thereof;  
FIG. 12 is a right side elevational view thereof;  
FIG. 13 is a top plan view thereof; and,  
FIG. 14 is a bottom plan view thereof.  
The broken line portion of the figure drawings is included to  
show unclaimed subject matter only and forms no part of the  
claimed designs.

**1 Claim, 8 Drawing Sheets**

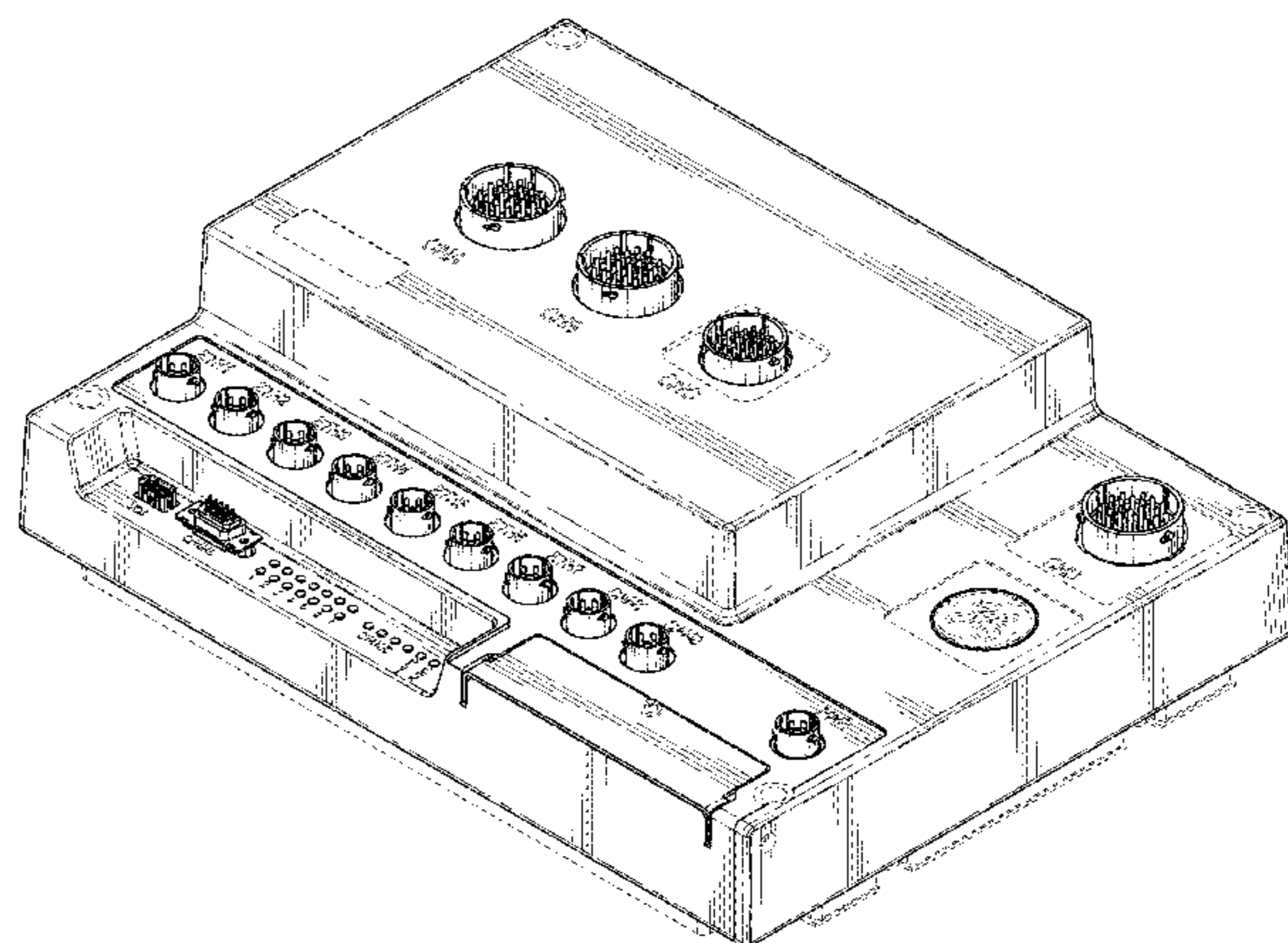
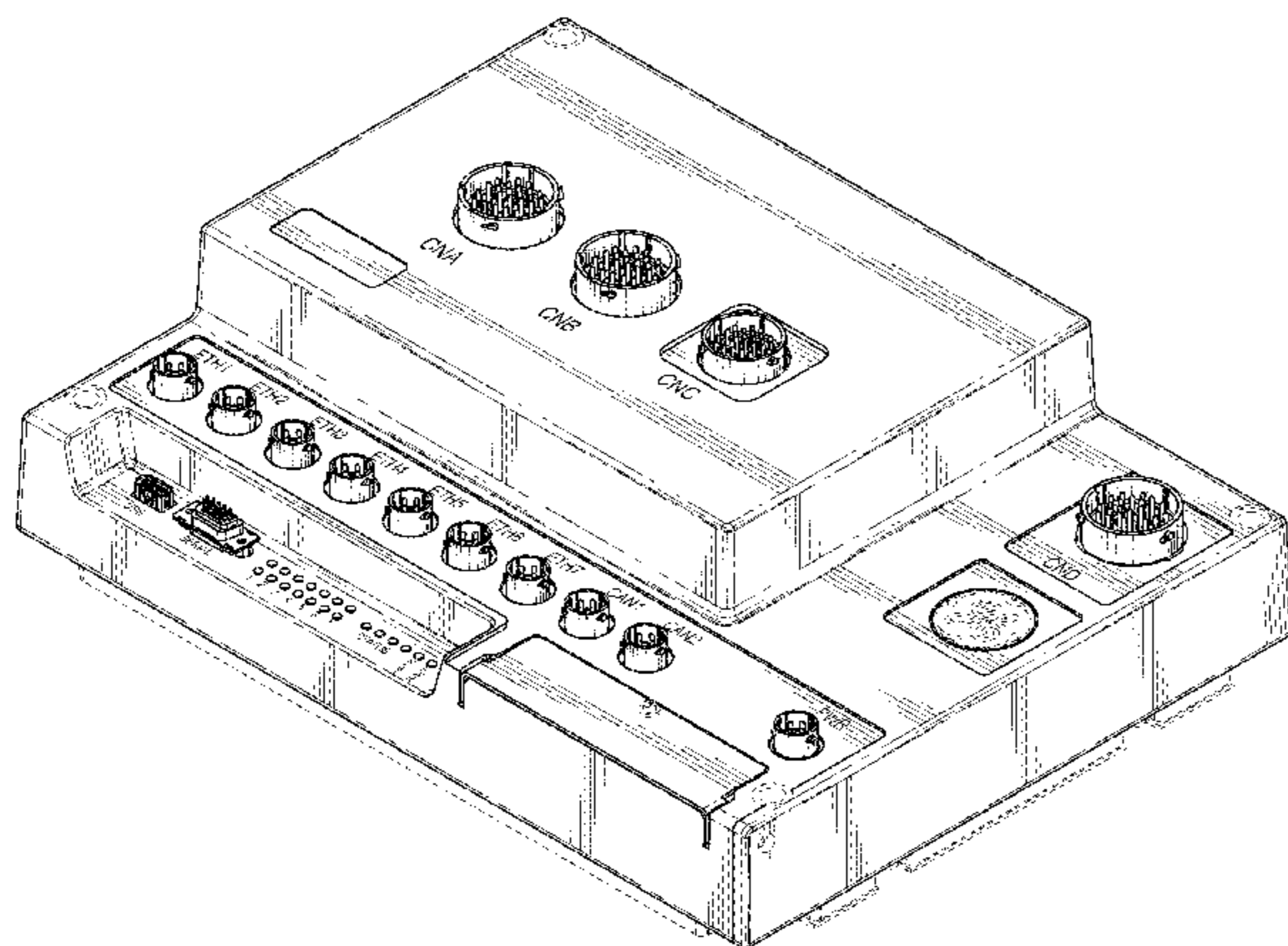

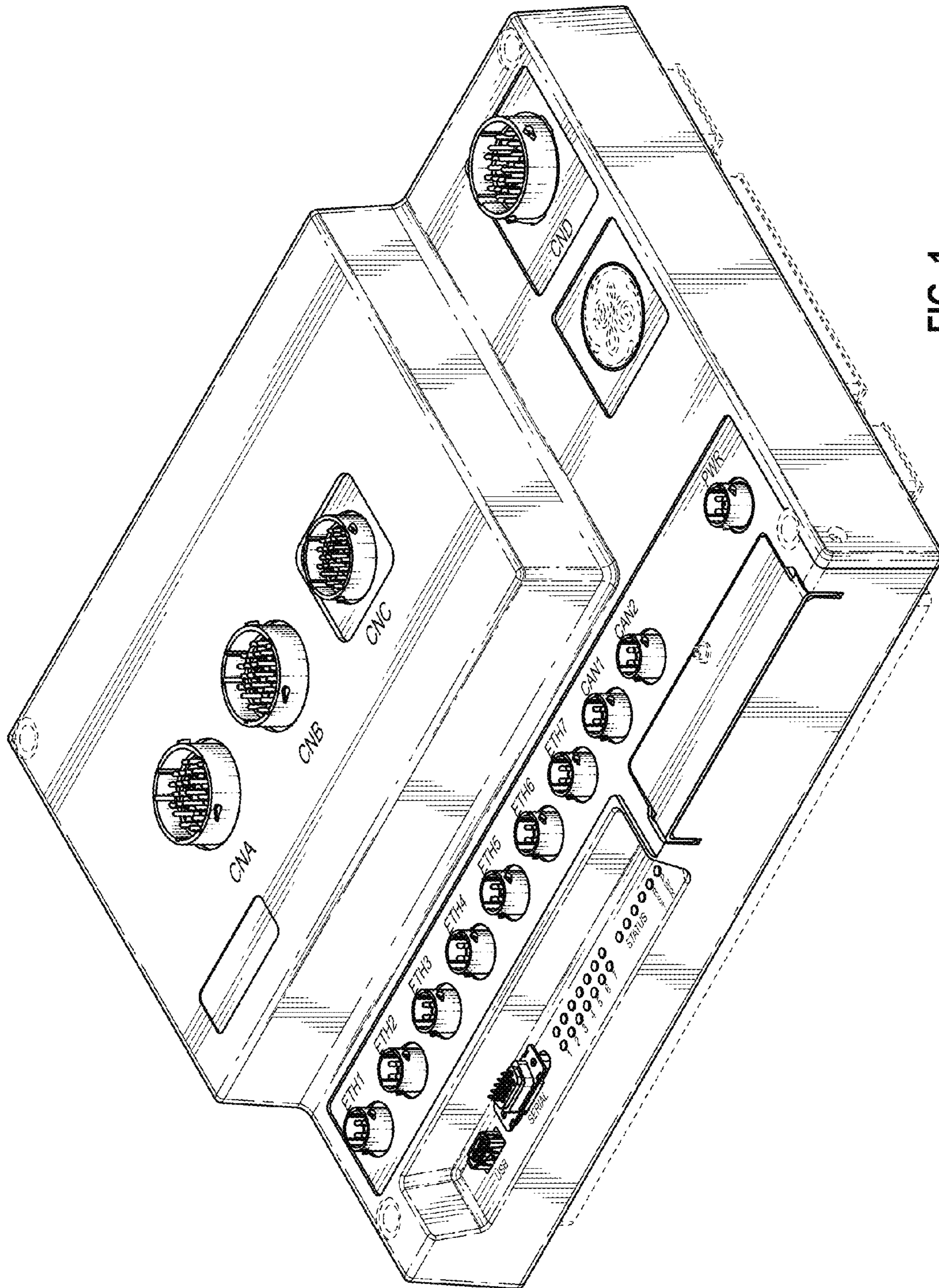

FIG. 1

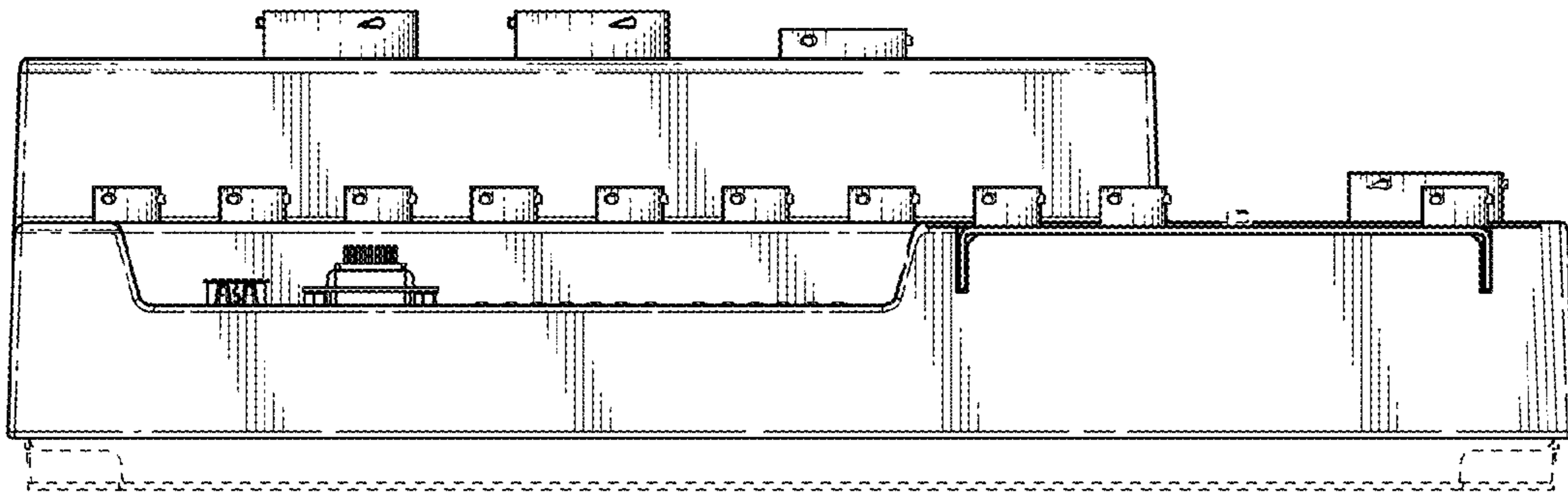

FIG. 2

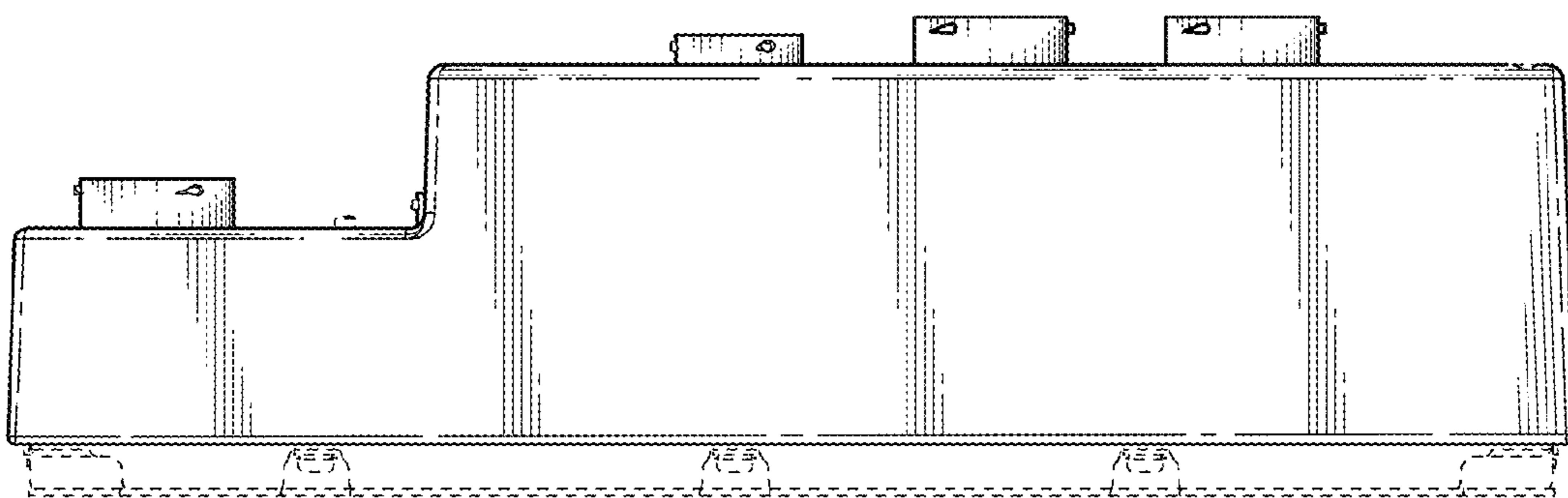

FIG. 3

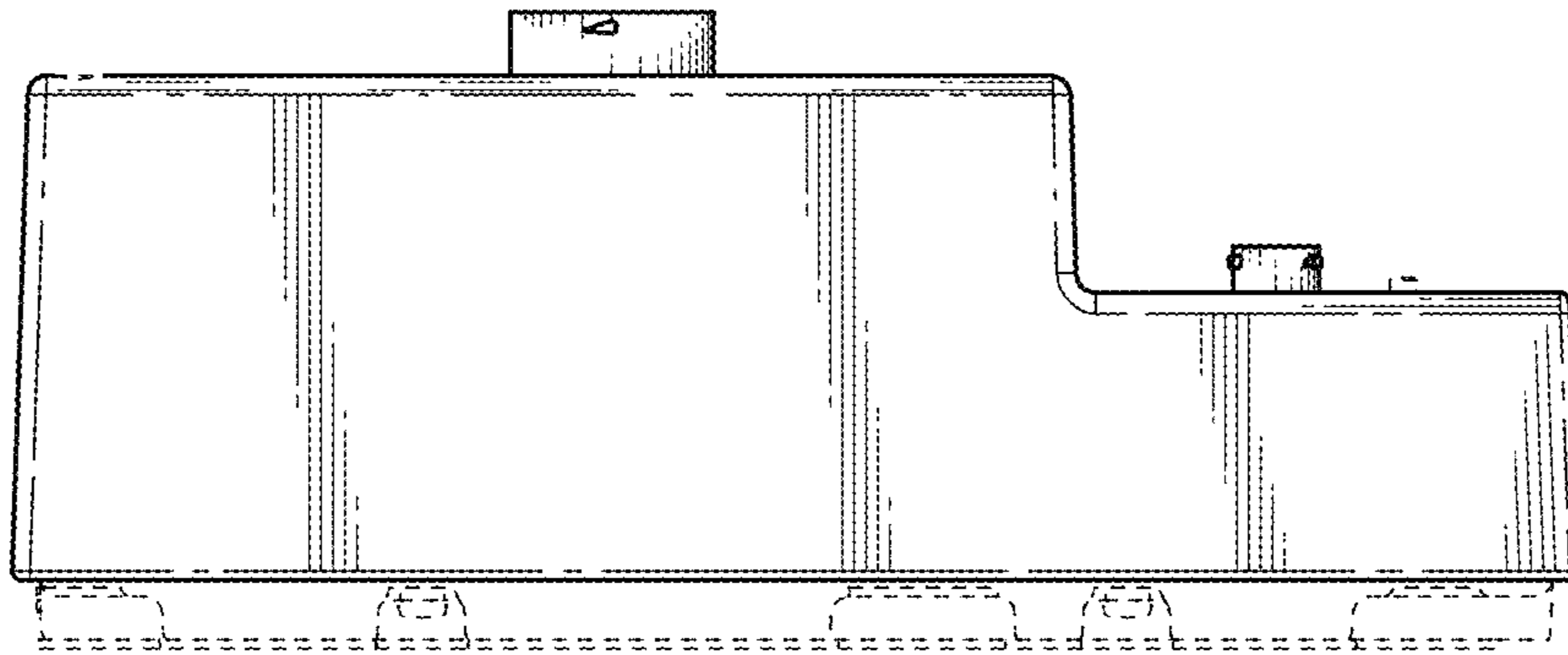

FIG. 4

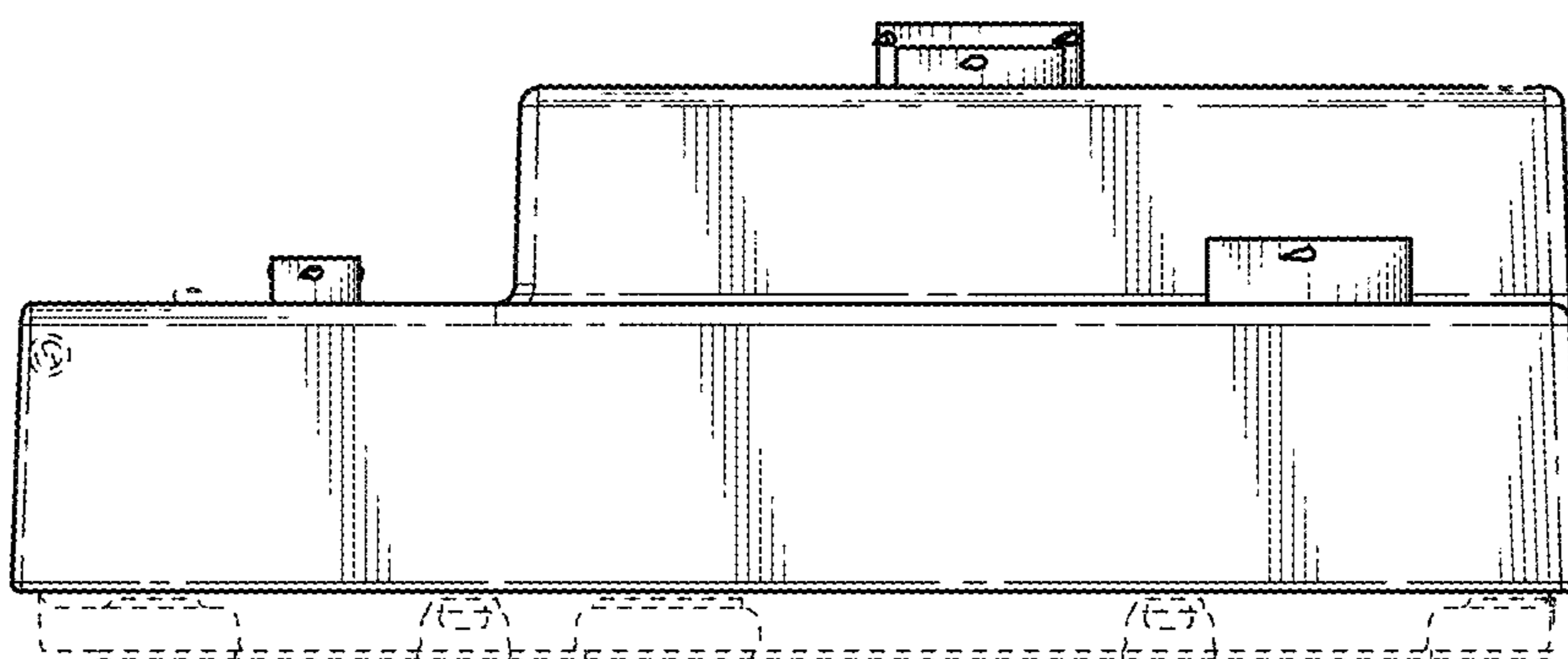

FIG. 5

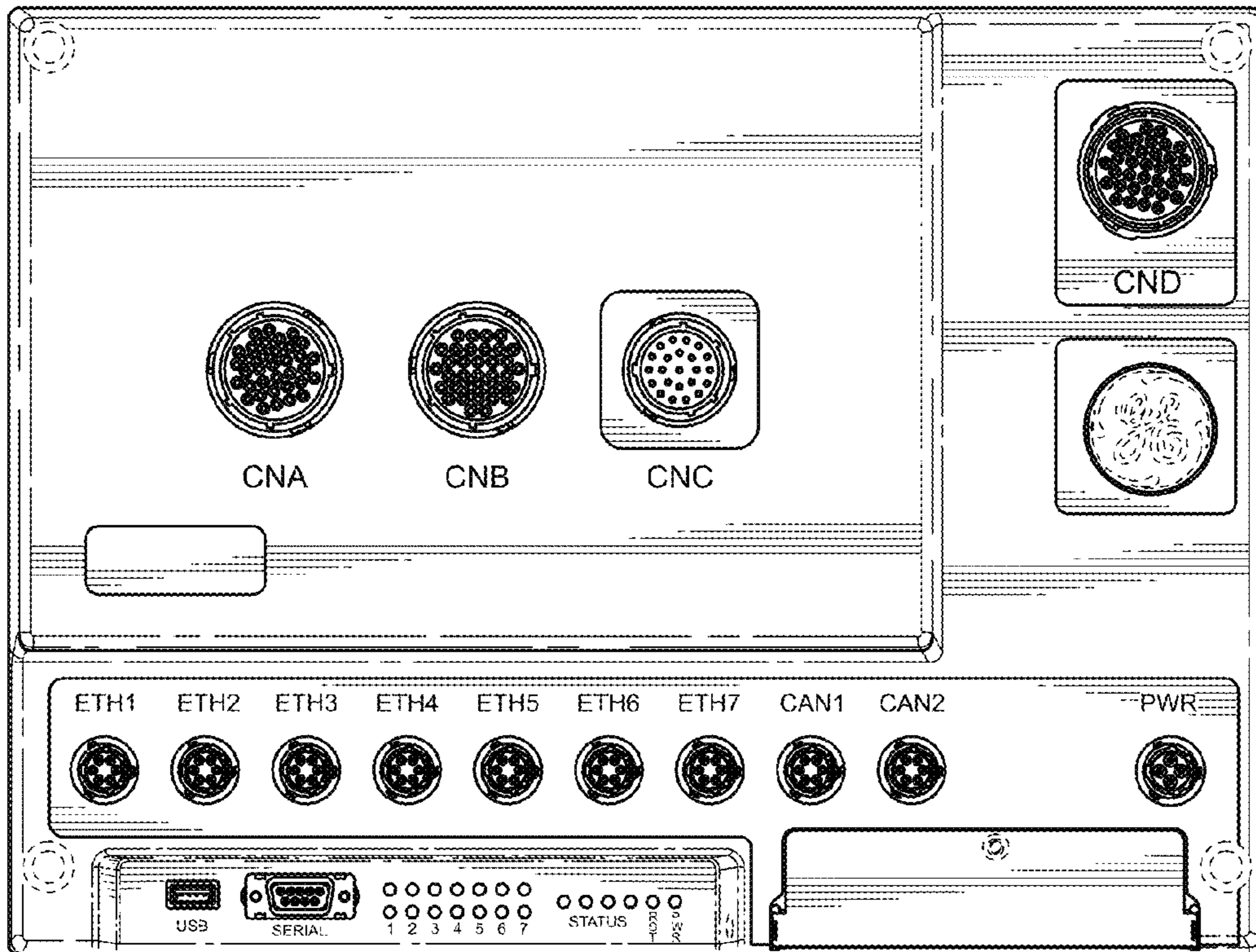

FIG. 6

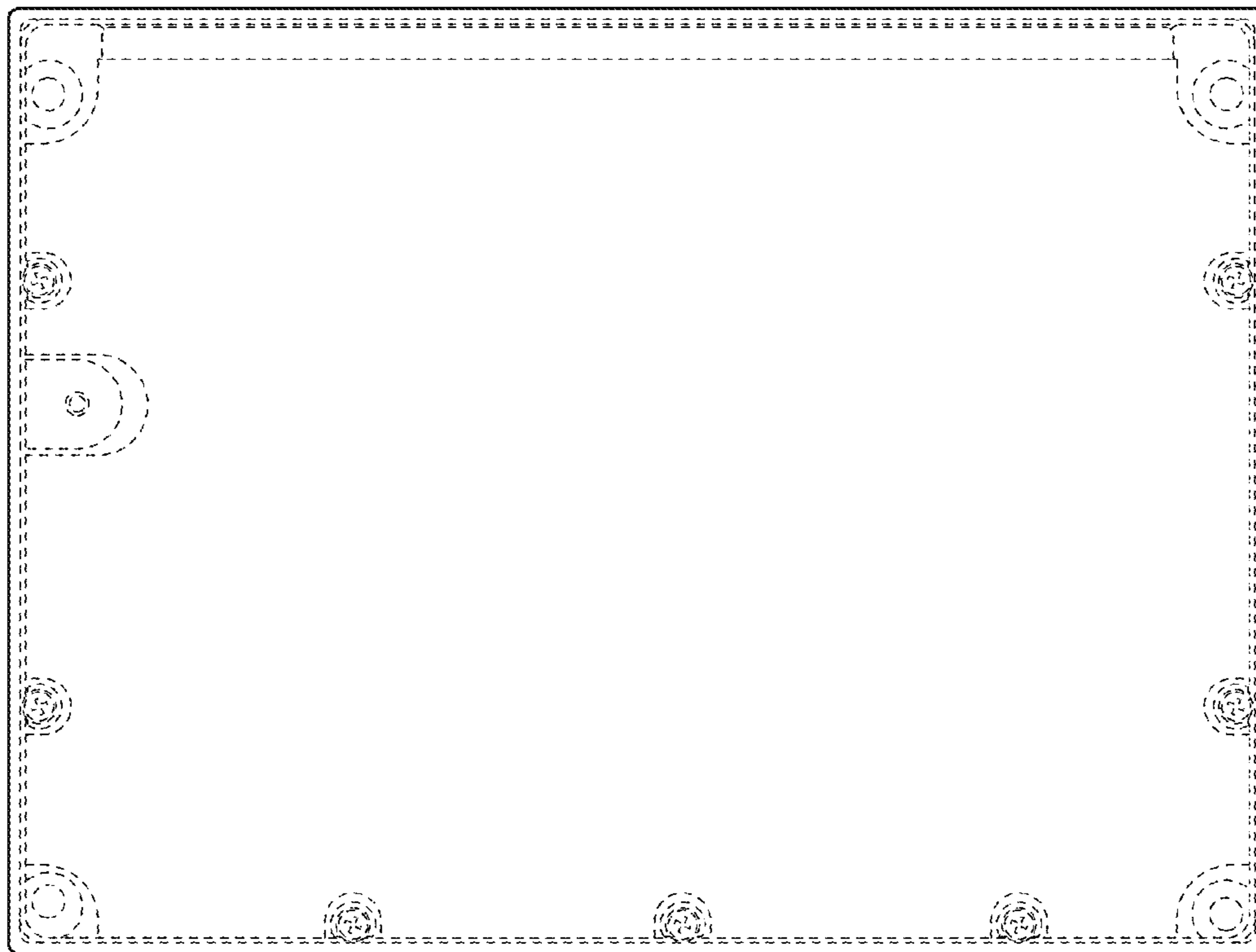

FIG. 7

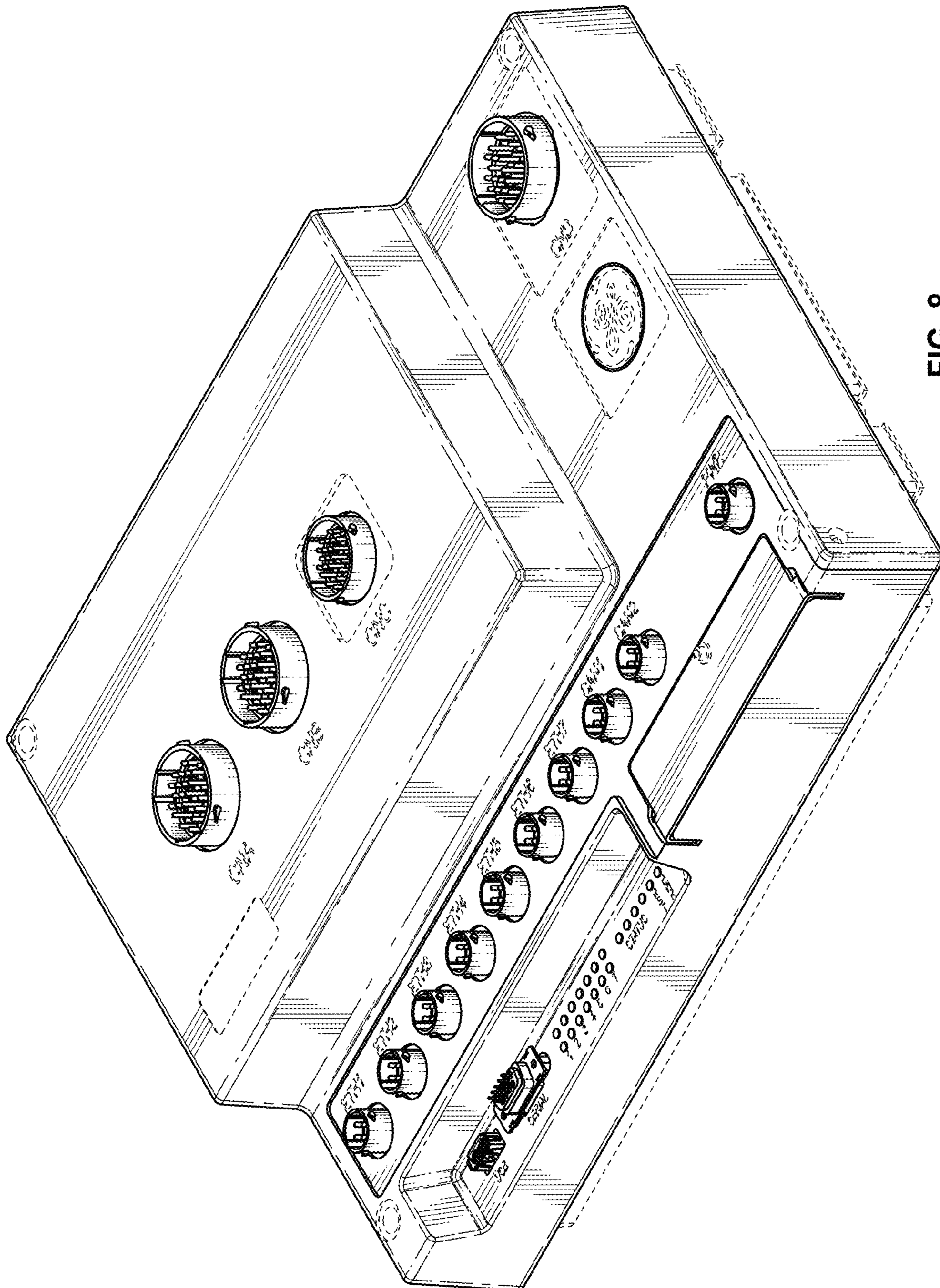

FIG. 8

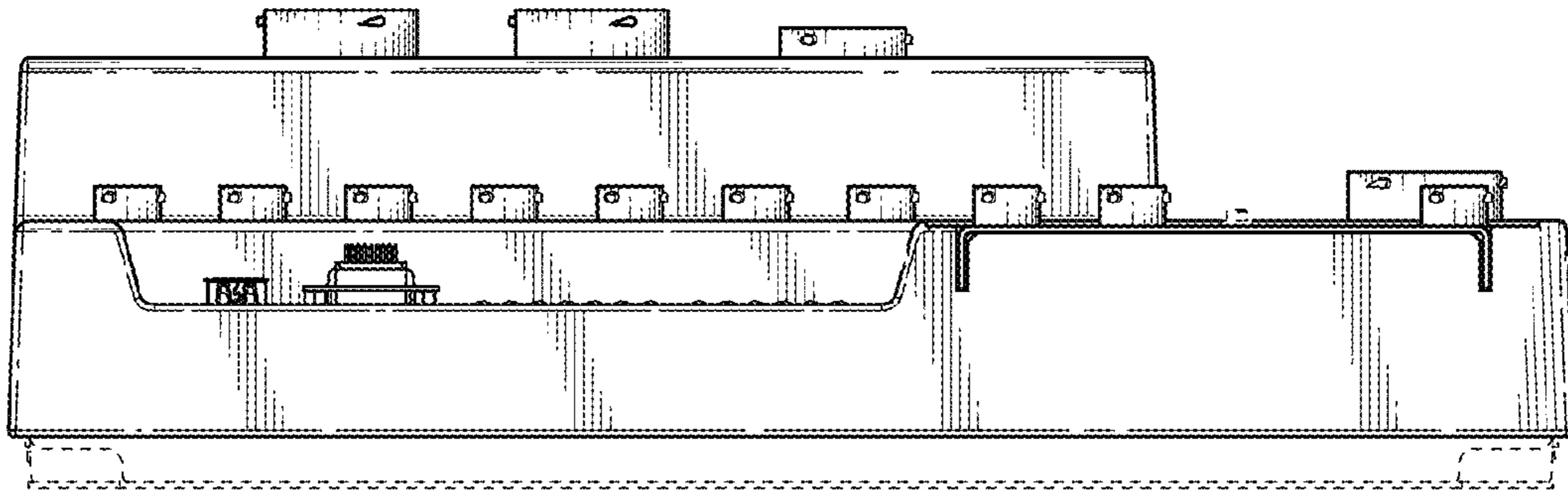

FIG. 9

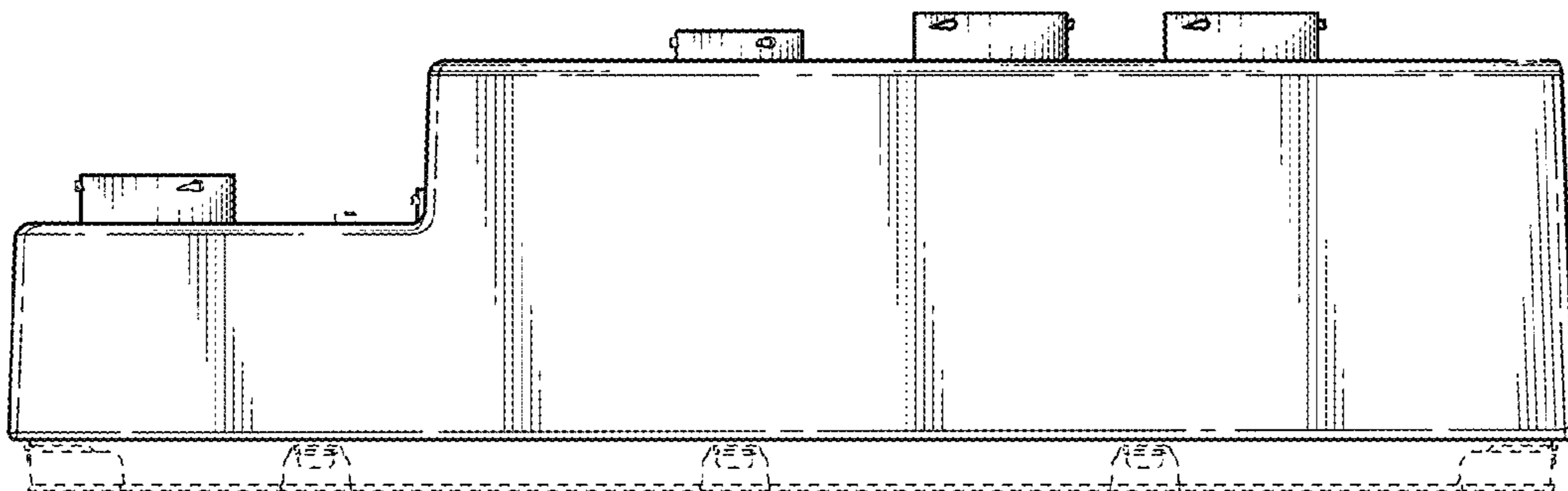

FIG. 10

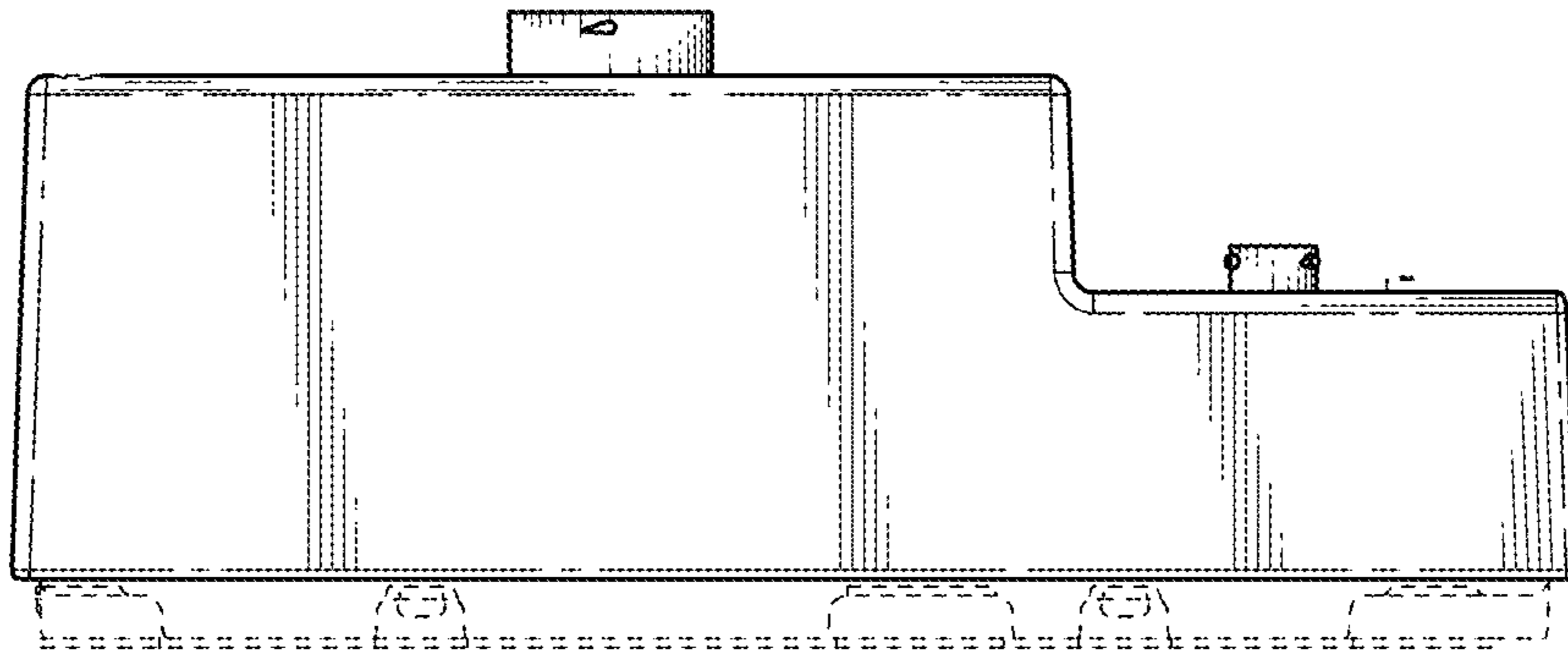

FIG. 11

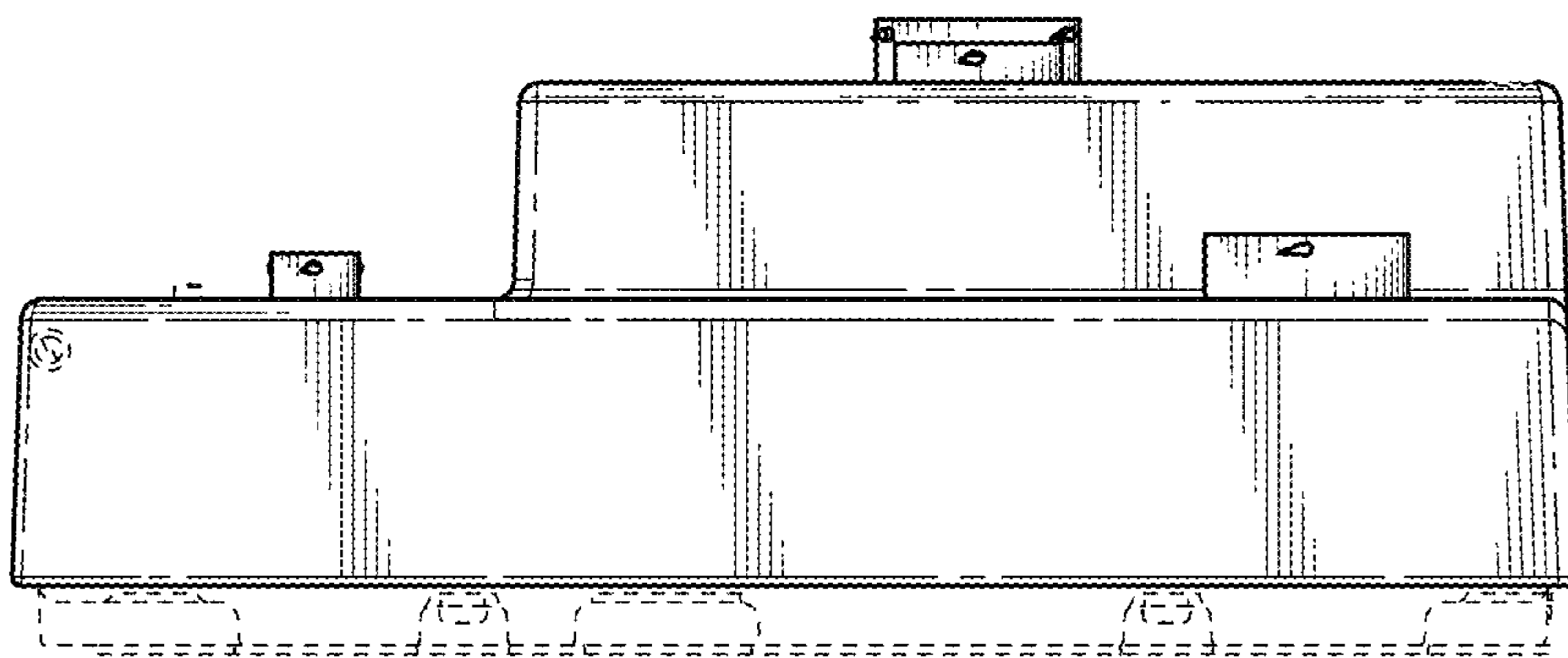

FIG. 12



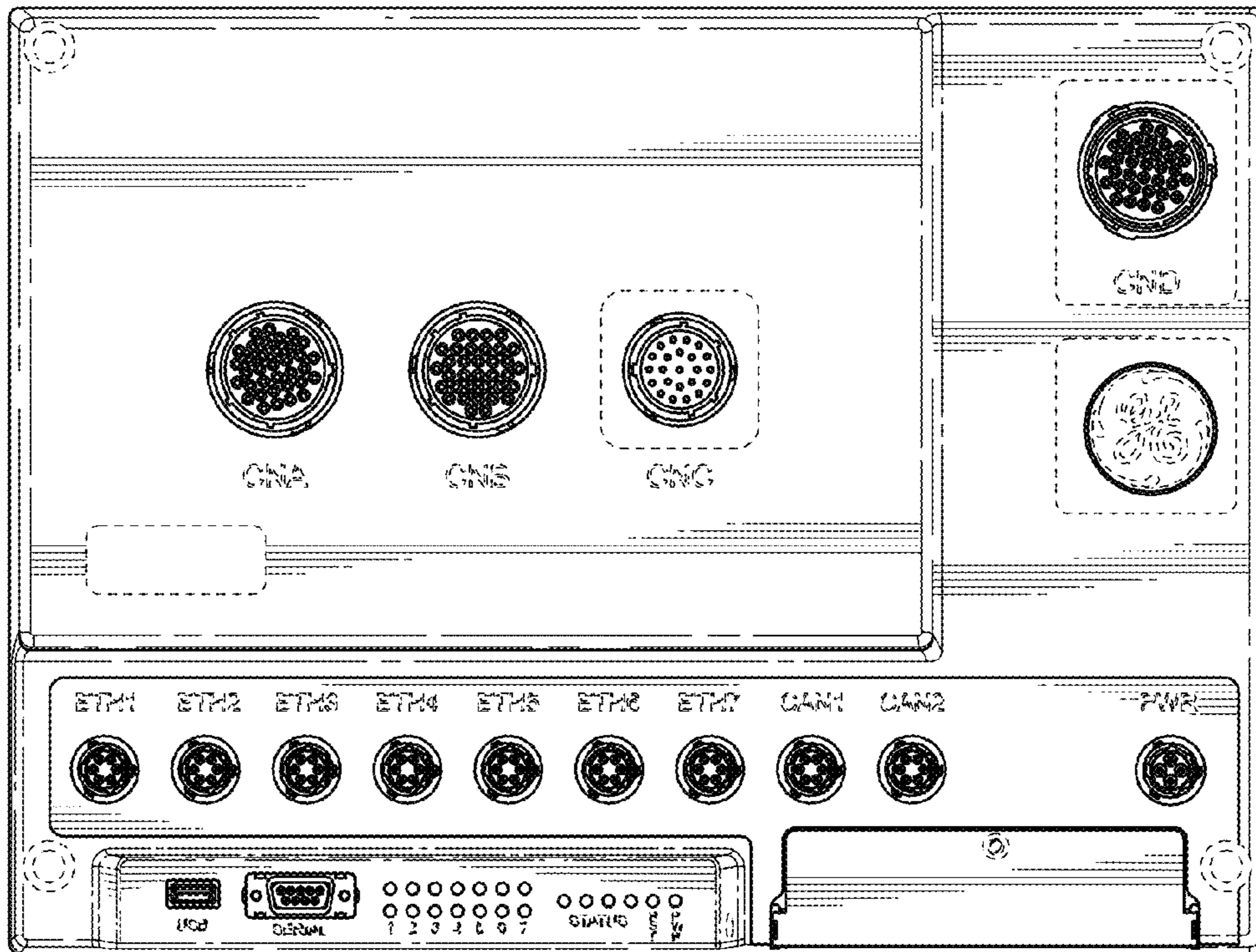

FIG. 13

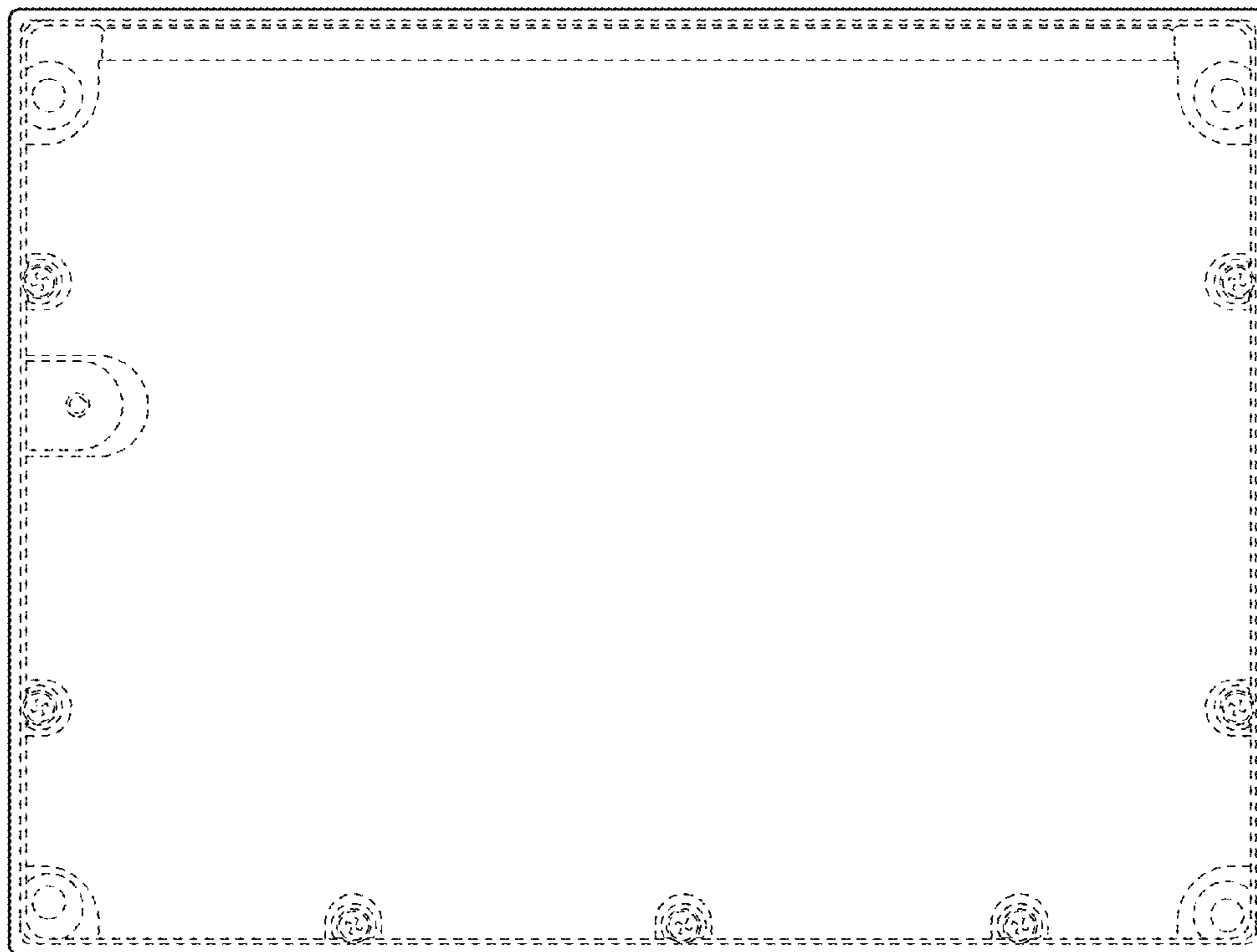

FIG. 14