



US00D762917S

(12) **United States Design Patent**  
**Nankil**

(10) **Patent No.:** **US D762,917 S**

(45) **Date of Patent:** **\*\* Aug. 2, 2016**

(54) **MOUNTING BRACKET FOR SUPPORTING A LUMINAIRE**

(71) Applicant: **Hubbell Incorporated**, Shelton, CT (US)

(72) Inventor: **Robert R. Nankil**, Buena Park, CA (US)

(73) Assignee: **Hubbell Incorporated**, Shelton, CT (US)

(\*\*) Term: **14 Years**

(21) Appl. No.: **29/491,215**

(22) Filed: **May 19, 2014**

**Related U.S. Application Data**

(62) Division of application No. 29/411,080, filed on Jan. 17, 2012, now Pat. No. Des. 707,882.

(51) **LOC (10) Cl.** ..... **26-99**

(52) **U.S. Cl.**  
USPC ..... **D26/142**

(58) **Field of Classification Search**

USPC ..... D26/25, 26, 28, 31, 35, 36, 37, 41, 42, D26/50, 51, 52, 64, 66, 67, 73, 75, 78, 85, D26/88, 89, 90, 103-106, 109, 110, 119, D26/123, 125, 129, 131, 135, 136, 138, 140, D26/143, 144; D13/179, 180; 362/92, 130, 362/132, 133, 183, 184, 190, 205, 216, 362/217.05, 218, 220, 223, 224, 241, 247, 362/249.03, 249.05-249.1, 249.11, 258, 362/260, 285, 287, 294.02, 297, 327, 345, 362/354, 373-379, 410, 418, 419, 510, 516, 362/558, 561; 248/339, 557, 558; D8/354, D8/373, 377, 382; D25/60, 119, 124, 125; 52/455; 349/59-62, 64-67, 113; 438/15; 345/102; D12/406; D10/111, D10/114.1; D11/121, 125, 144, 145; 428/11; 257/96, 97, 98, 99

CPC ..... F21S 8/086; F21S 8/036  
See application file for complete search history.

(56) **References Cited**

U.S. PATENT DOCUMENTS

168,705 A 10/1875 Barcellos  
D24,909 S 11/1895 Corscaden

(Continued)

*Primary Examiner* — Zenia Bennett

(74) *Attorney, Agent, or Firm* — Michael Best & Friedrich, LLP

(57) **CLAIM**

The ornamental design for a mounting bracket for supporting a luminaire, as shown and described.

**DESCRIPTION**

FIG. 1 is a perspective view of a mounting bracket for supporting a luminaire;

FIG. 2 is an elevation view of the mounting bracket for supporting a luminaire of FIG. 1;

FIG. 3 is a side elevation view of the mounting bracket for supporting a luminaire of FIG. 1;

FIG. 4 is a side elevation view of the mounting bracket for supporting a luminaire of FIG. 1, opposite the side elevation view of FIG. 3;

FIG. 5 is a plan view of the mounting bracket for supporting a luminaire of FIG. 1;

FIG. 6 is a plan view of the mounting bracket for supporting a luminaire of FIG. 1, opposite the plan view of FIG. 5;

FIG. 7 is a perspective view of a mounting bracket for supporting a luminaire according to another embodiment;

FIG. 8 is an elevation view of the mounting bracket for supporting a luminaire of FIG. 7;

FIG. 9 is a side elevation view of the mounting bracket for supporting a luminaire of FIG. 7;

FIG. 10 is a side elevation view of the mounting bracket for supporting a luminaire of FIG. 7, opposite the side elevation view of FIG. 9;

FIG. 11 is a plan view of the mounting bracket for supporting a luminaire of FIG. 7; and,

FIG. 12 is a plan view of the mounting bracket for supporting a luminaire of FIG. 7, opposite the plan view of FIG. 11.

The back views form no part of the claimed design. The aspects shown in broken lines do not form part of the claimed design.

**1 Claim, 10 Drawing Sheets**

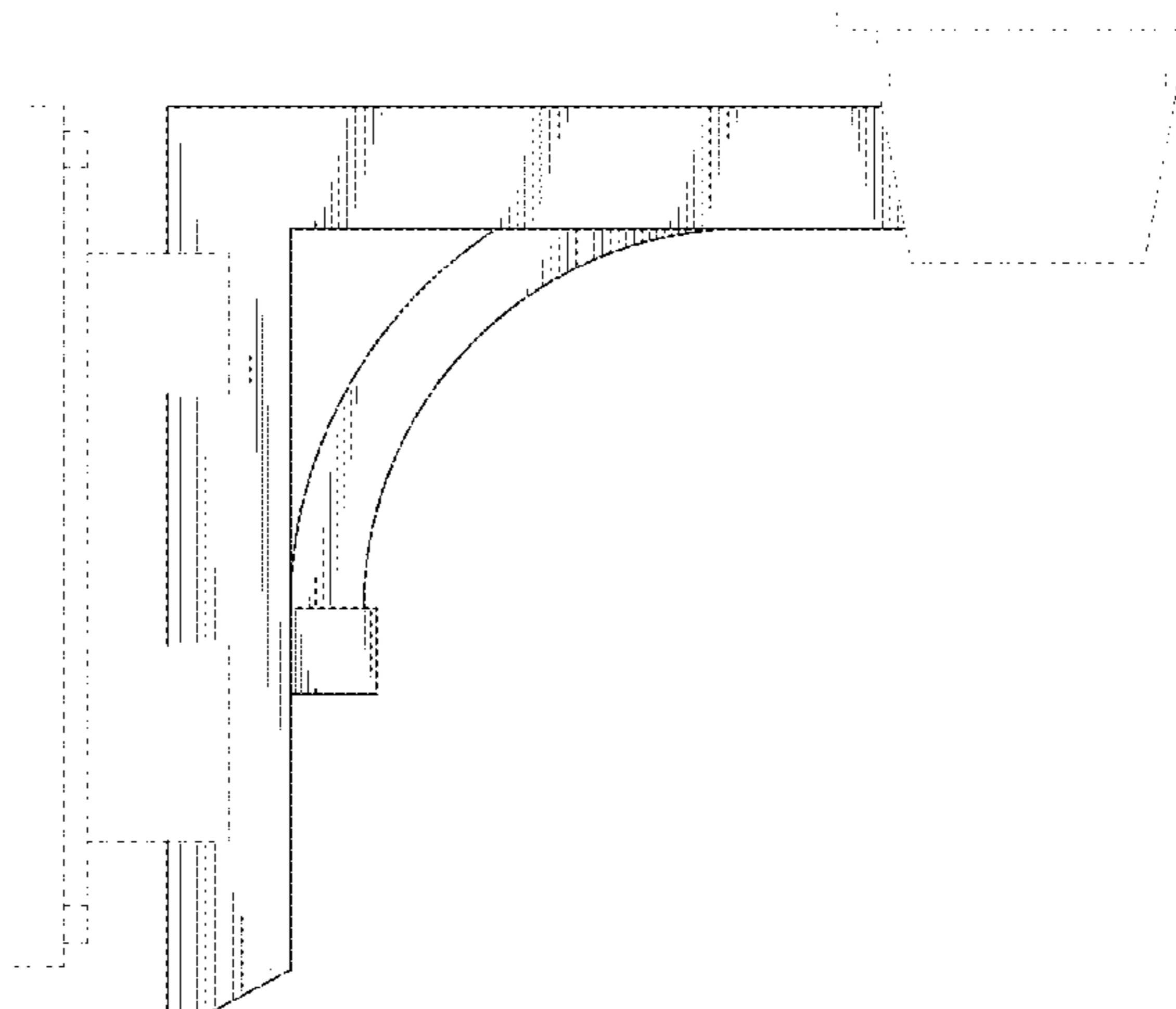
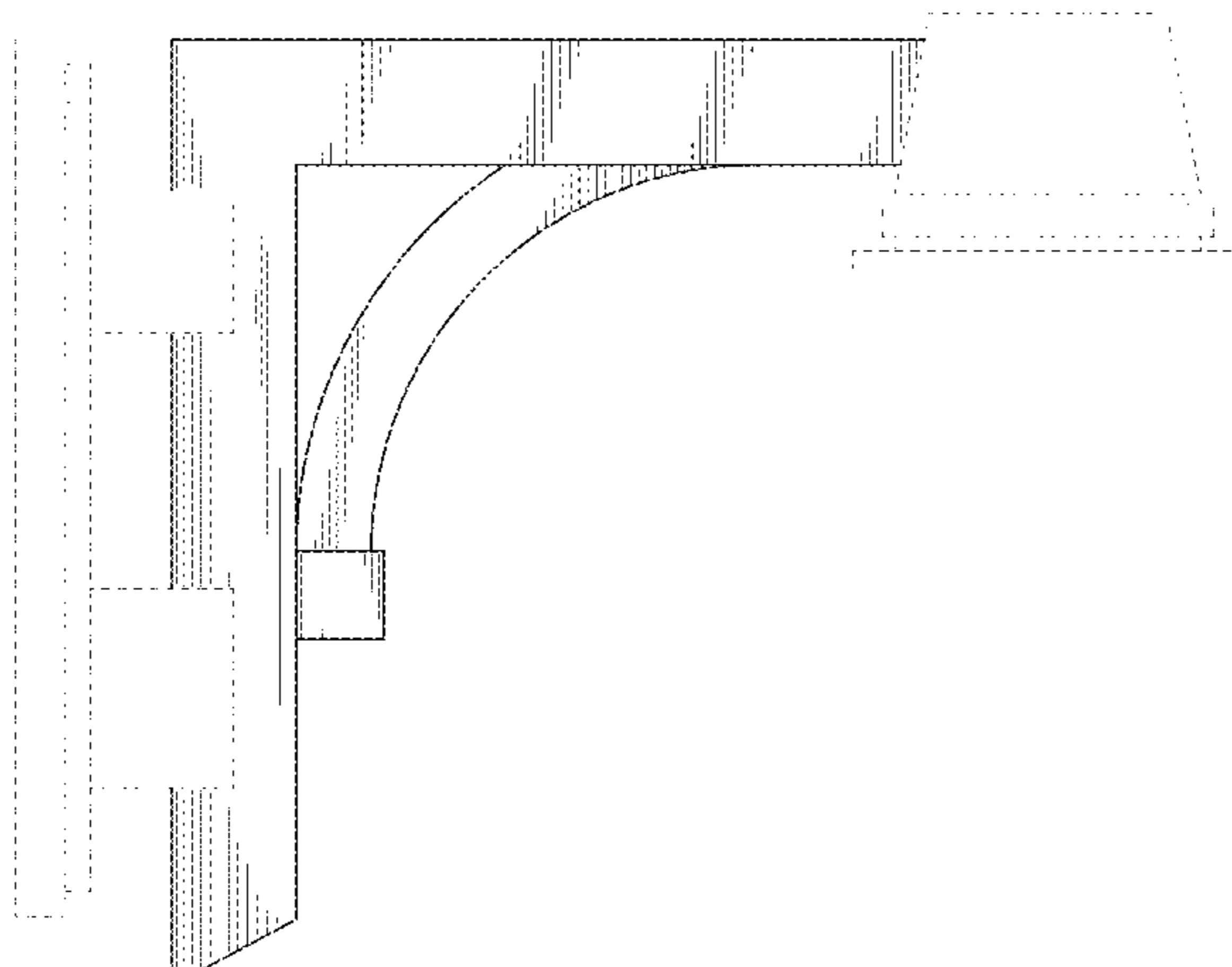

(56)

**References Cited**

U.S. PATENT DOCUMENTS

D52,076 S 6/1918 Holstein  
D340,405 S 10/1993 Anderson  
5,667,188 A \* 9/1997 Bettinsoli ..... 248/558  
D426,914 S 6/2000 Jaspers-Fayer et al.  
D444,260 S 6/2001 Dolan  
D454,975 S 3/2002 De'Armond et al.  
D461,592 S 8/2002 De'Armond et al.

D491,307 S 6/2004 Curtin  
D522,164 S 5/2006 Trivino et al.  
D537,189 S 2/2007 Zhang  
2001/0022728 A1 \* 9/2001 Klaus et al. .... 362/418  
2002/0136002 A1 9/2002 Hoernig  
2013/0027923 A1 \* 1/2013 Ramirez ..... 362/208  
2013/0322063 A1 \* 12/2013 Tittle ..... 362/183  
2014/0133164 A1 \* 5/2014 Pfund et al. .... 362/368  
2014/0246971 A1 \* 9/2014 Carpenter et al. .... 313/46

\* cited by examiner

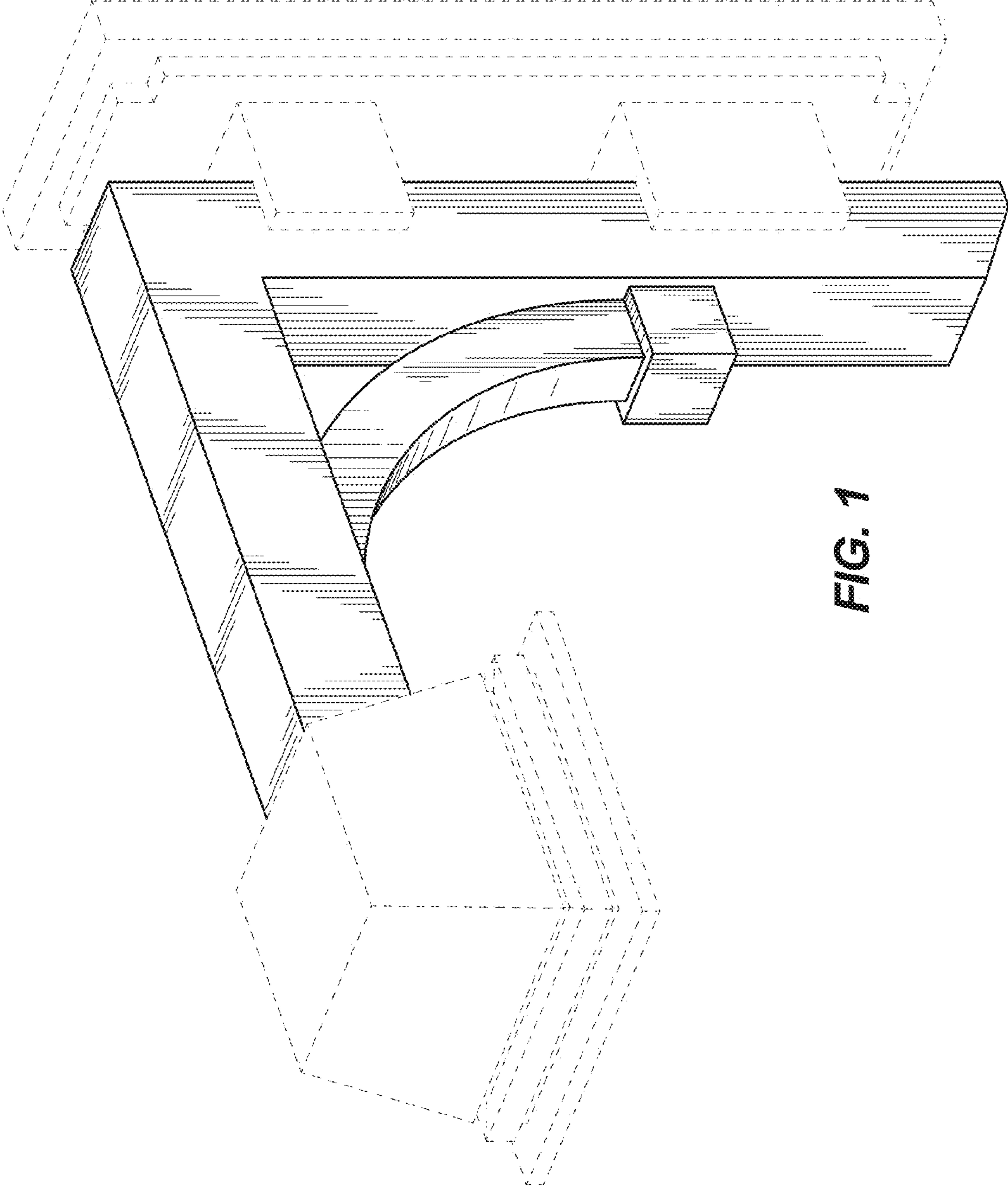
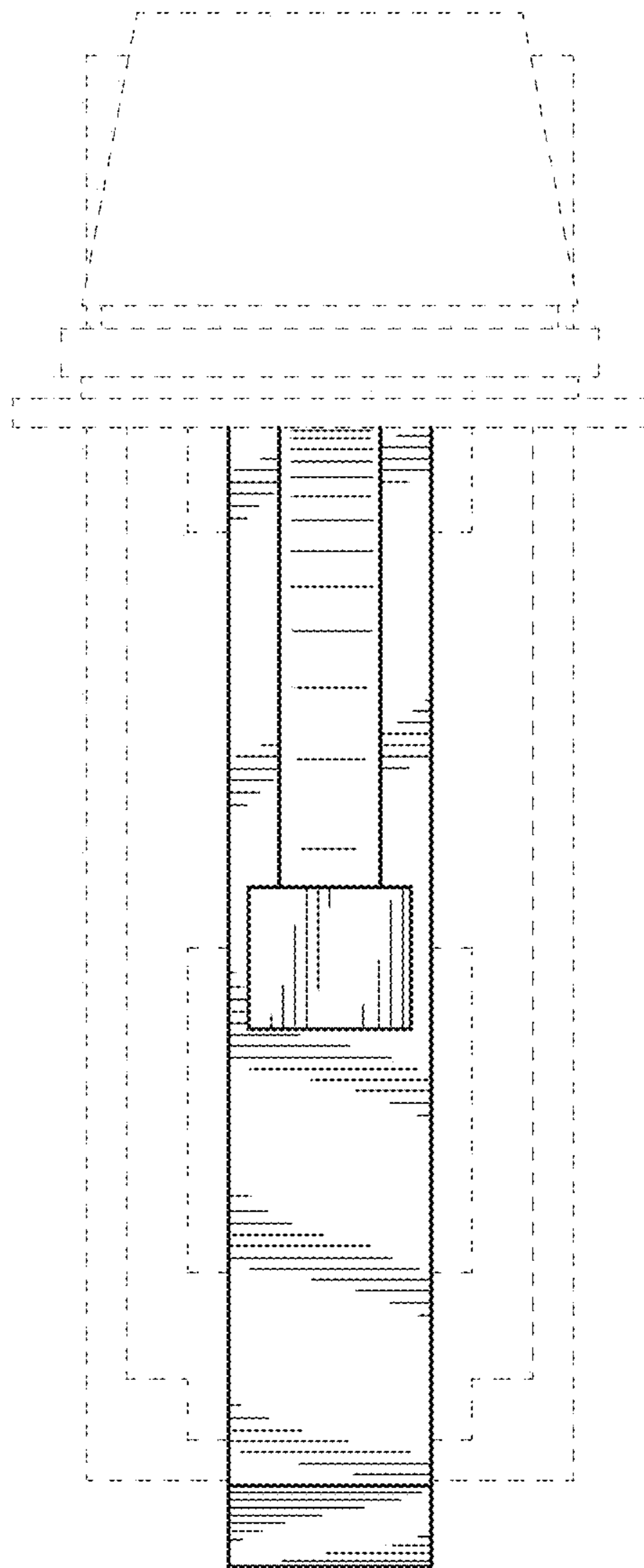
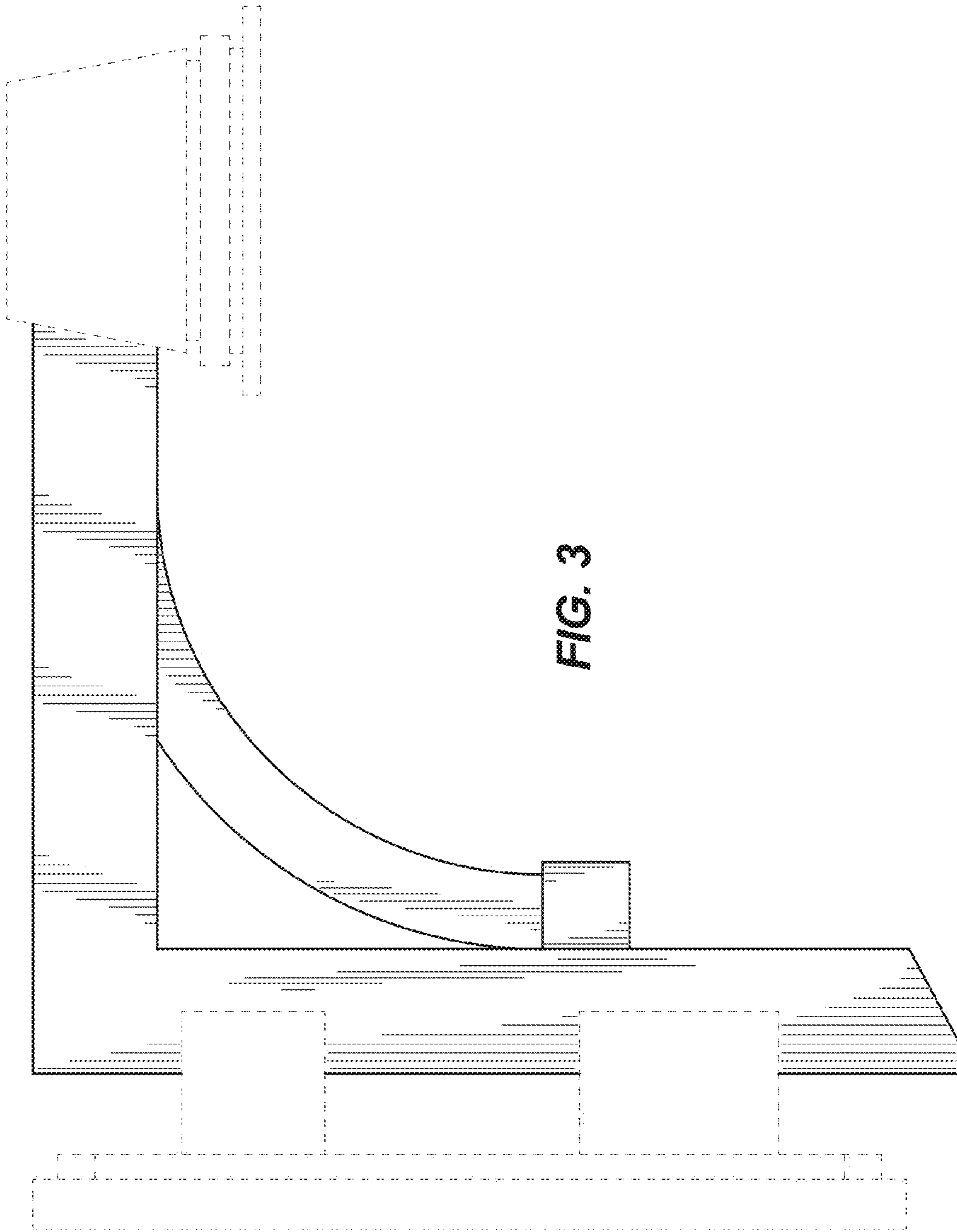

FIG. 1



**FIG. 2**



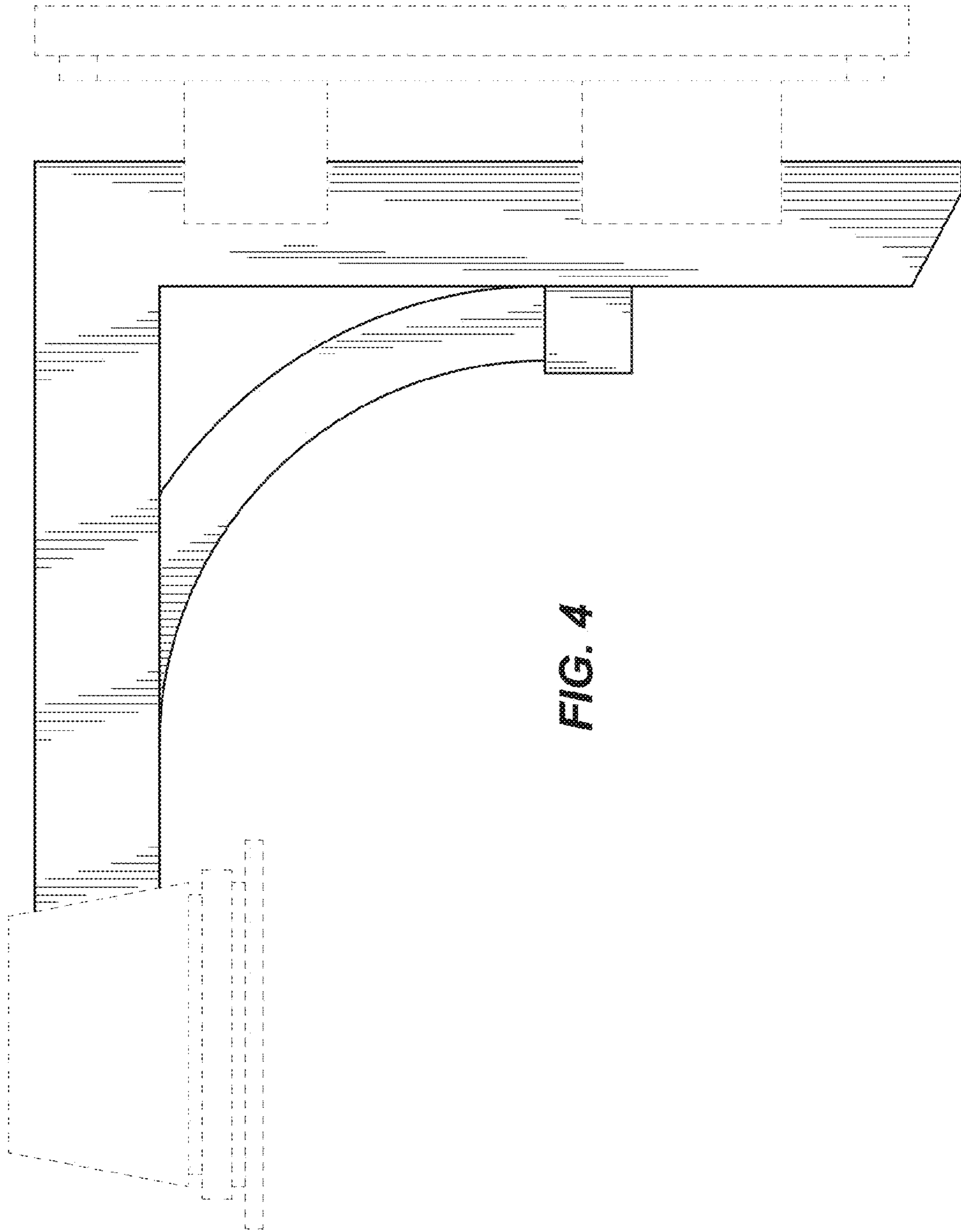
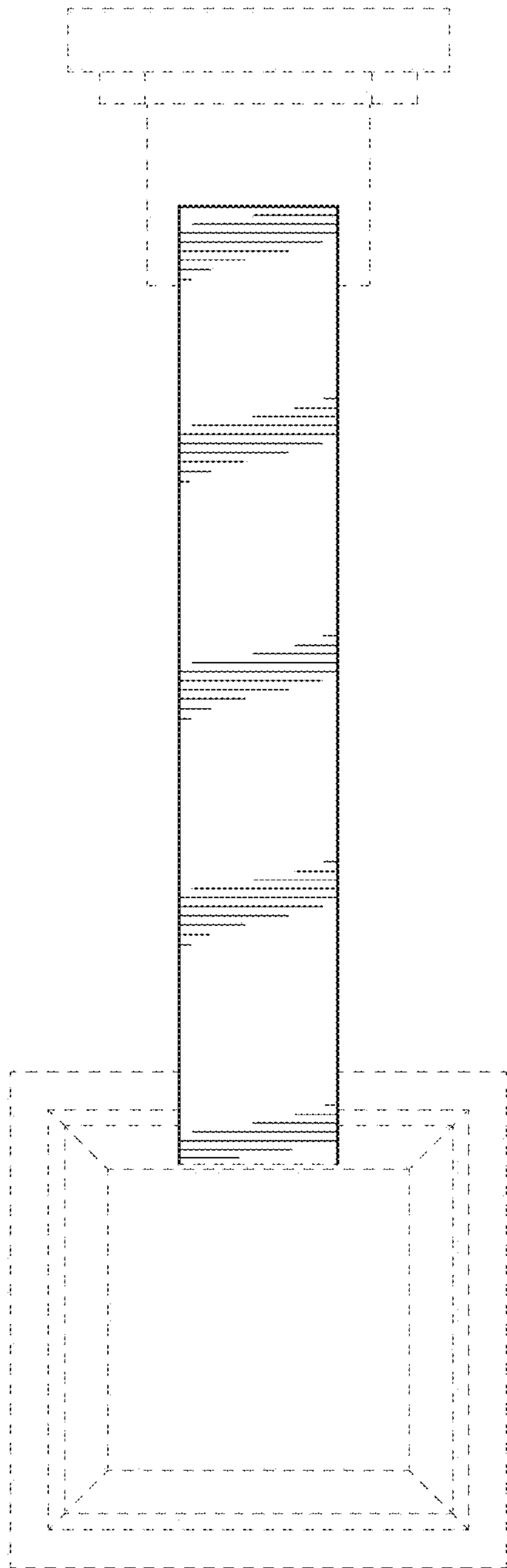
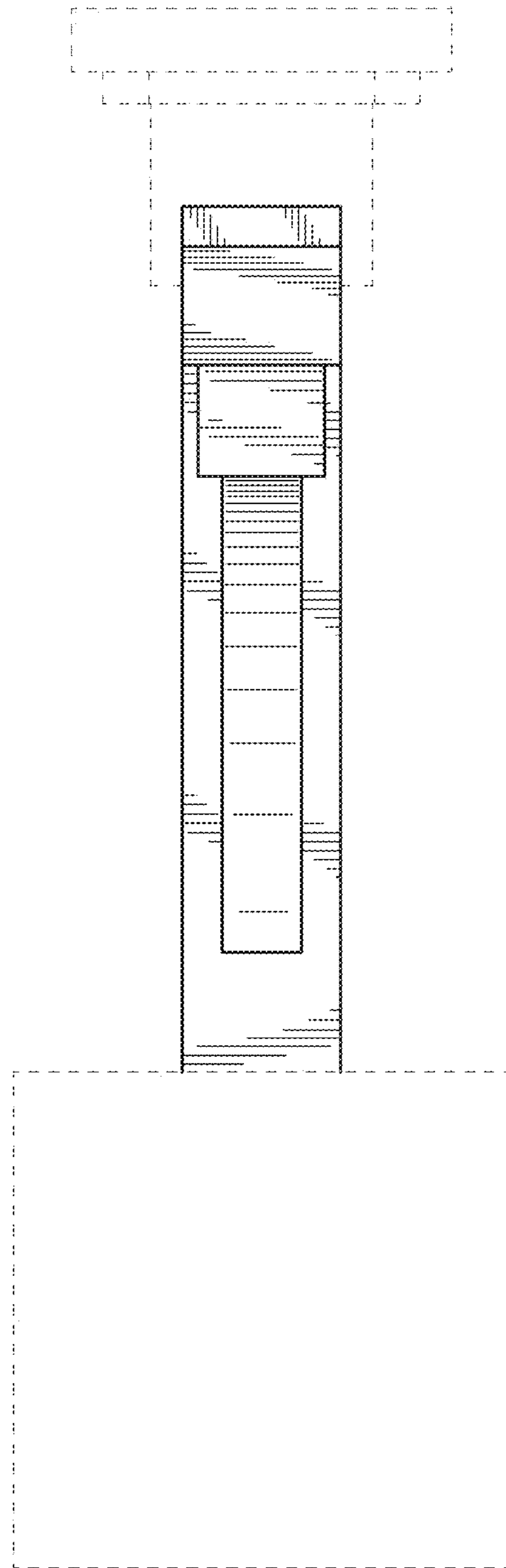

FIG. 4



**FIG. 5**



**FIG. 6**

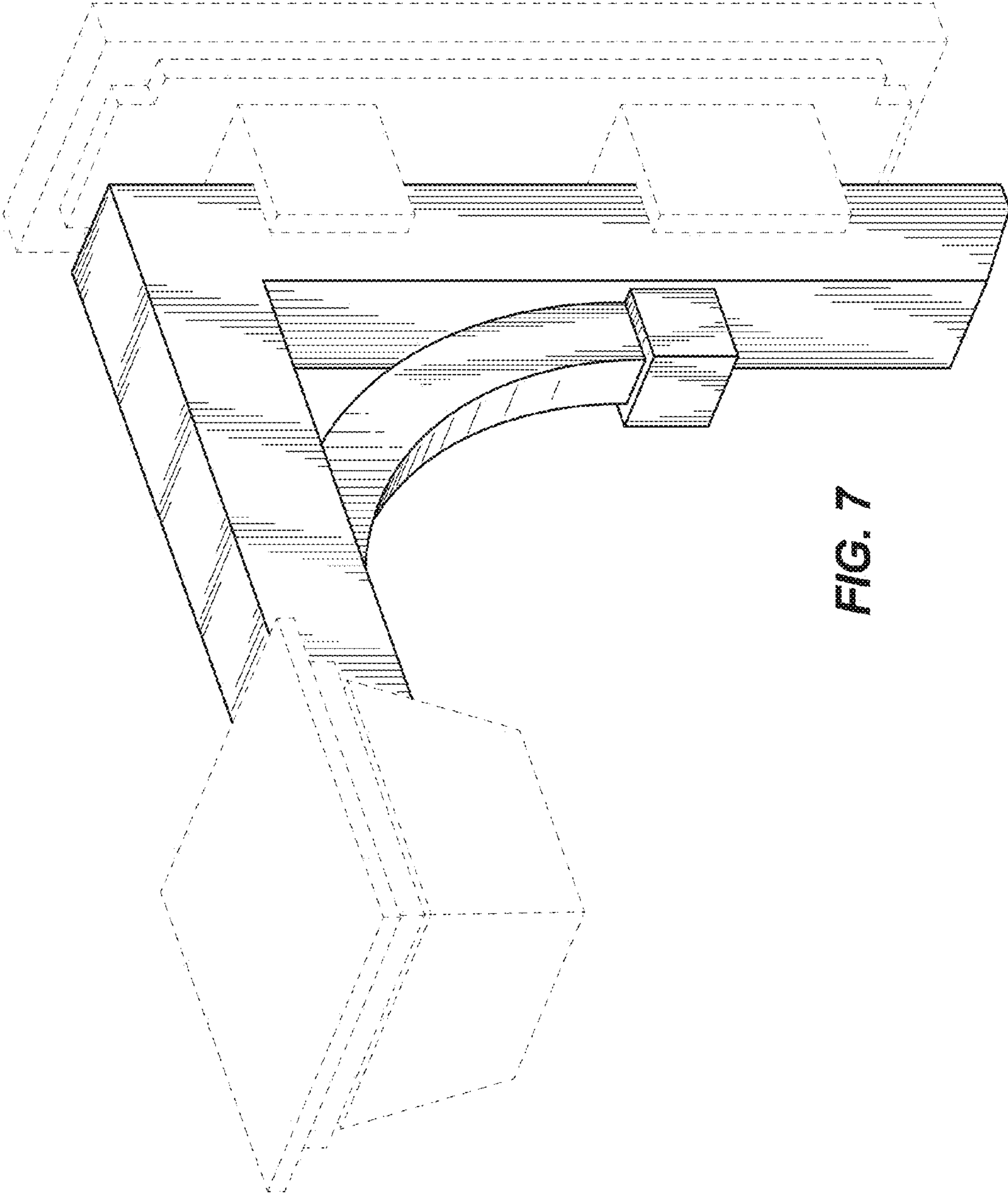
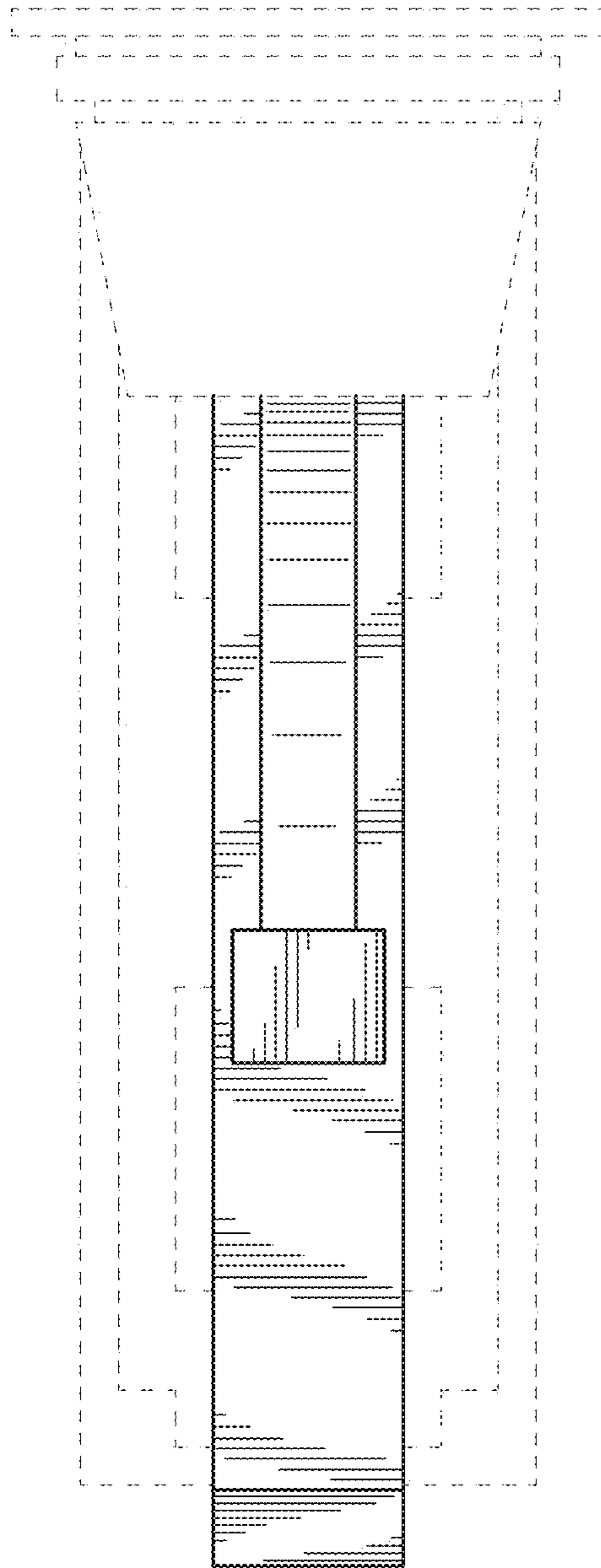

FIG. 7





**FIG. 8**

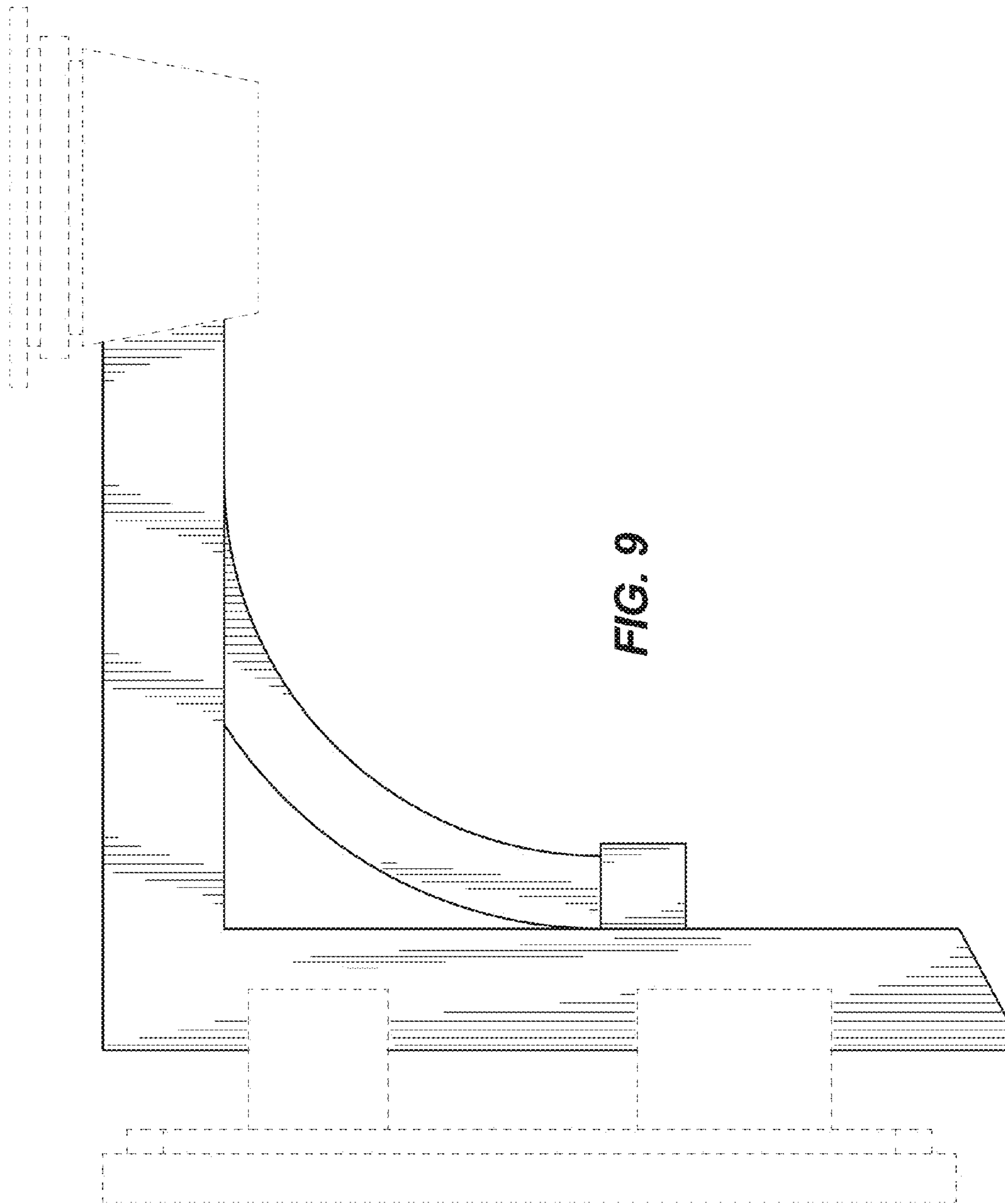

FIG. 9

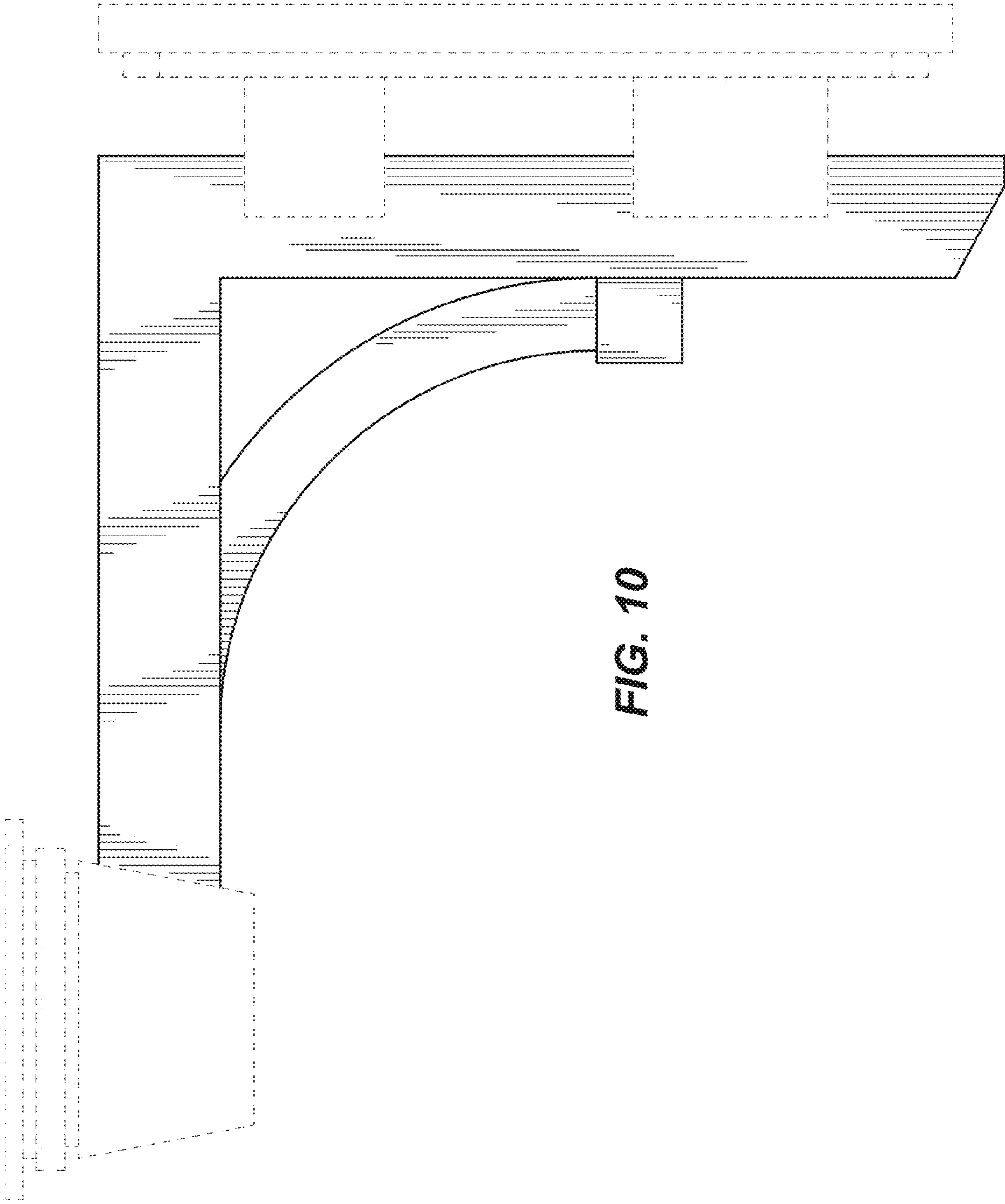
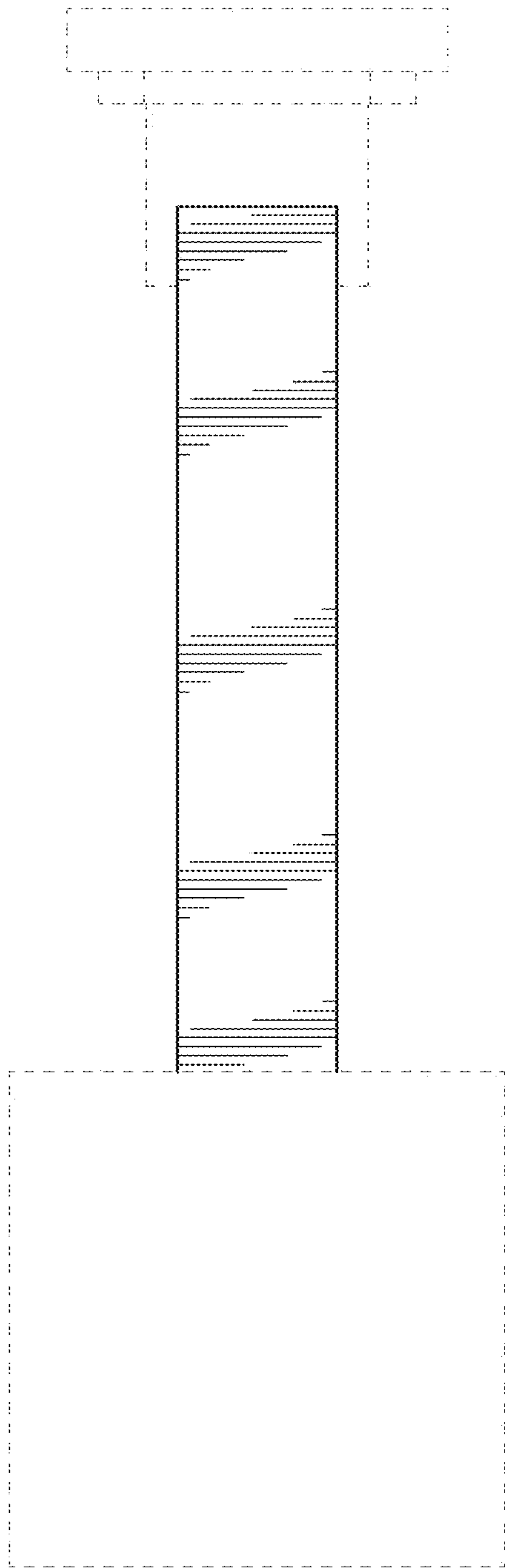
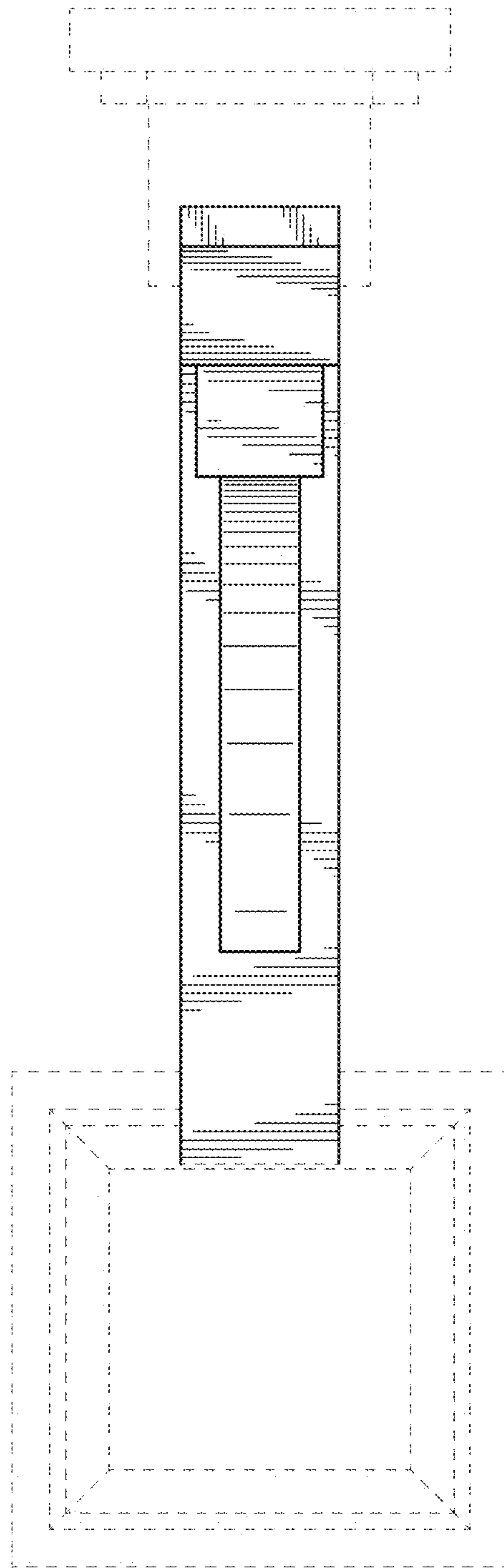

FIG. 10



**FIG. 11**



**FIG. 12**