



US00D762904S

(12) **United States Design Patent**
Schmitt

(10) **Patent No.:** **US D762,904 S**
(45) **Date of Patent:** **** Aug. 2, 2016**

(54) **PLANT GROW LIGHT**

(71) Applicant: **Robert D. Schmitt**, Littleton, CO (US)

(72) Inventor: **Robert D. Schmitt**, Littleton, CO (US)

(73) Assignee: **Heated Edge System, Inc.**, Littleton, CO (US)

(**) Term: **14 Years**

(21) Appl. No.: **29/525,347**

(22) Filed: **Apr. 29, 2015**

(51) **LOC (10) Cl.** **26-05**

(52) **U.S. Cl.**
USPC **D26/68; D26/71**

(58) **Field of Classification Search**

USPC D26/60, 63, 67-71
CPC ... F21V 3/0445; F21V 21/32; F21V 21/0824;
F21S 6/005; F21S 6/0032; F21S 8/081;
F21S 8/083; F21S 8/085; F21S 8/088; F21W
2131/103; F21W 2131/109

See application file for complete search history.

(56) **References Cited**

U.S. PATENT DOCUMENTS

D207,273 S * 3/1967 Muller D26/68
D236,909 S * 9/1975 Richilano D26/68

(Continued)

Primary Examiner — Clare E Hefflin

(74) *Attorney, Agent, or Firm* — Colorado Patents

(57) **CLAIM**

The ornamental design for a plant grow light, as shown and described.

DESCRIPTION

FIG. 1 is a perspective view of a first embodiment of my new design for a plant grow light shown mounted in a planter for a plant as also shown;

FIG. 2 is a top plan view of the plant grow light and planter of FIG. 1 as they would appear with the plant of FIG. 1 removed; FIG. 3 is a bottom plan view of the plant grow light and planter of FIG. 2;

FIG. 4 is a front view of the plant grow light and planter of FIG. 2;

FIG. 5 is a rear view of the plant grow light and planter of FIG. 2; and,

FIG. 6 is a left side view the plant grow light and planter of FIG. 2 and wherein the right side view of the plant grow light and planter is the mirror image of the left side view of FIG. 6; FIG. 7 is a perspective view of a second embodiment of my new design for a plant grow light shown mounted in a planter for a plant as also shown;

FIG. 8 is a top plan view of the plant grow light and planter of FIG. 7 as they would appear with the plant of FIG. 7 removed; FIG. 9 is a bottom plan view of the plant grow light and planter of FIG. 8;

FIG. 10 is a front view of the plant grow light and planter of FIG. 8;

FIG. 11 is a rear view of the plant grow light and planter of FIG. 8; and,

FIG. 12 is a left side view the plant grow light and planter of FIG. 8 and wherein the right side view of the plant grow light and planter is the mirror image of the left side view of FIG. 12; FIG. 13 is a perspective view of a third embodiment of my new design for a plant grow light shown mounted in a planter for a plant as also shown;

FIG. 14 is a top plan view of the plant grow light and planter of FIG. 13 as they would appear with the plant of FIG. 13 removed;

FIG. 15 is a bottom plan view of the plant grow light and planter of FIG. 14;

FIG. 16 is a front view of the plant grow light and planter of FIG. 14;

FIG. 17 is a rear view of the plant grow light and planter of FIG. 14; and,

FIG. 18 is a left side view the plant grow light and planter of FIG. 14 and wherein the right side view of the plant grow light and planter is the mirror image of the left side view of FIG. 18. The broken lines shown on the drawings depict environment only and form no part of the claimed design.

1 Claim, 6 Drawing Sheets

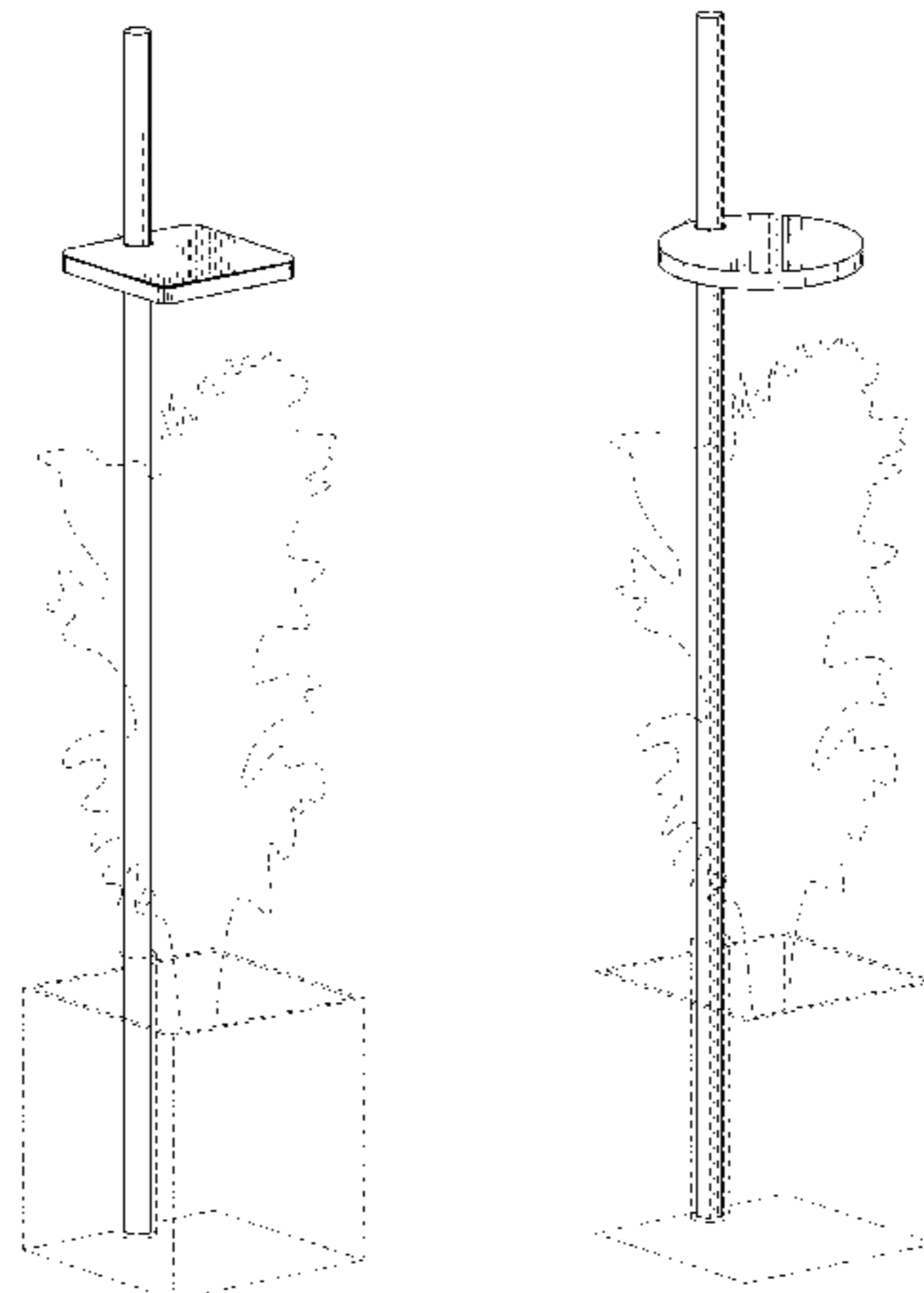

(56)

References Cited

U.S. PATENT DOCUMENTS

4,561,208 A 12/1985 Schultz
 D313,482 S * 1/1991 Compton D26/107
 D341,221 S * 11/1993 Elazari D26/68
 6,060,658 A * 5/2000 Yoshida F21S 8/086
 136/243
 D482,482 S * 11/2003 Schreder D26/71
 D522,163 S * 5/2006 Begasse D26/71
 7,040,053 B1 5/2006 Beesley
 D597,694 S * 8/2009 Dworschak D26/68
 D600,847 S * 9/2009 Wung D26/71
 D608,486 S * 1/2010 Chien D26/71

D610,731 S * 2/2010 Lenz D26/69
 D612,526 S * 3/2010 Lundin D26/71
 D620,171 S * 7/2010 Pauschitz D26/71
 D624,690 S * 9/2010 Thompson D26/71
 D625,453 S * 10/2010 Morton D26/68
 D679,042 S * 3/2013 Yu D26/69
 8,523,385 B2 9/2013 Lu et al.
 D711,033 S * 8/2014 Choi D26/71
 D743,080 S * 11/2015 Verelst D26/68
 D743,608 S * 11/2015 Verelst D26/68
 D743,609 S * 11/2015 Verelst D26/68
 2009/0000189 A1 1/2009 Black
 2010/0277078 A1 11/2010 Morton

* cited by examiner

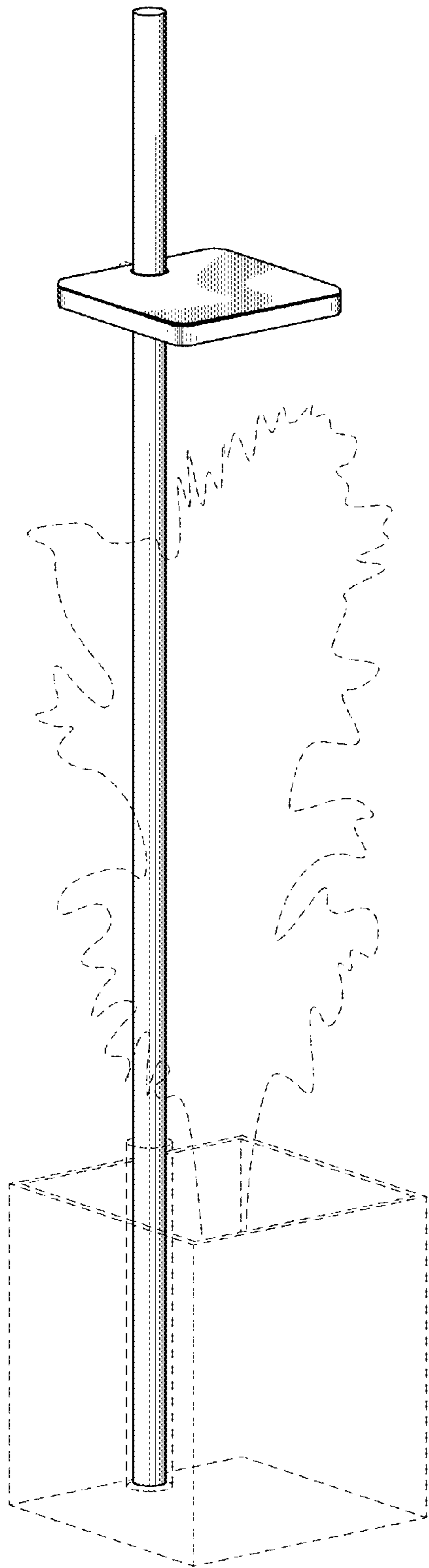

FIG. 1

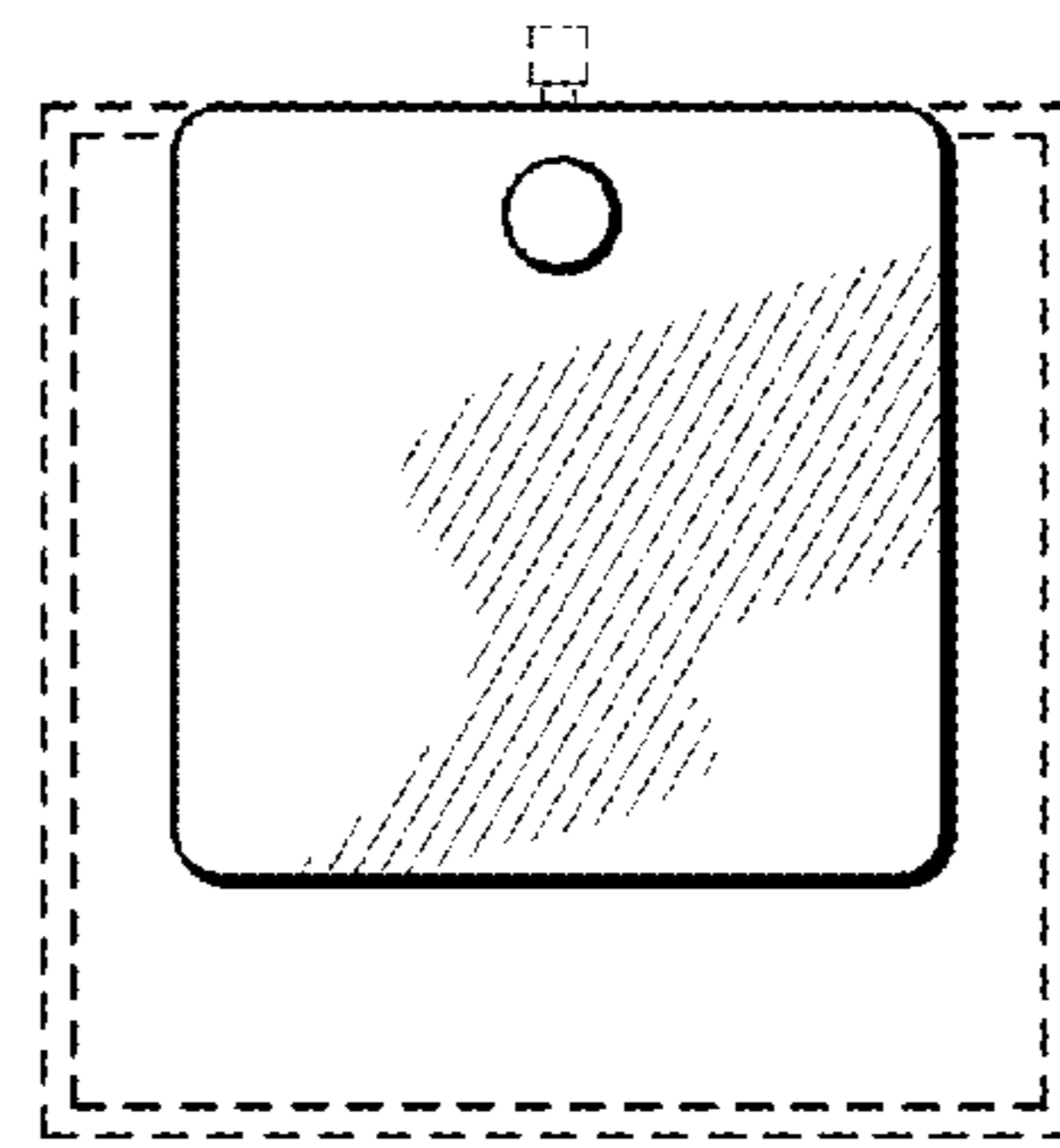

FIG. 2

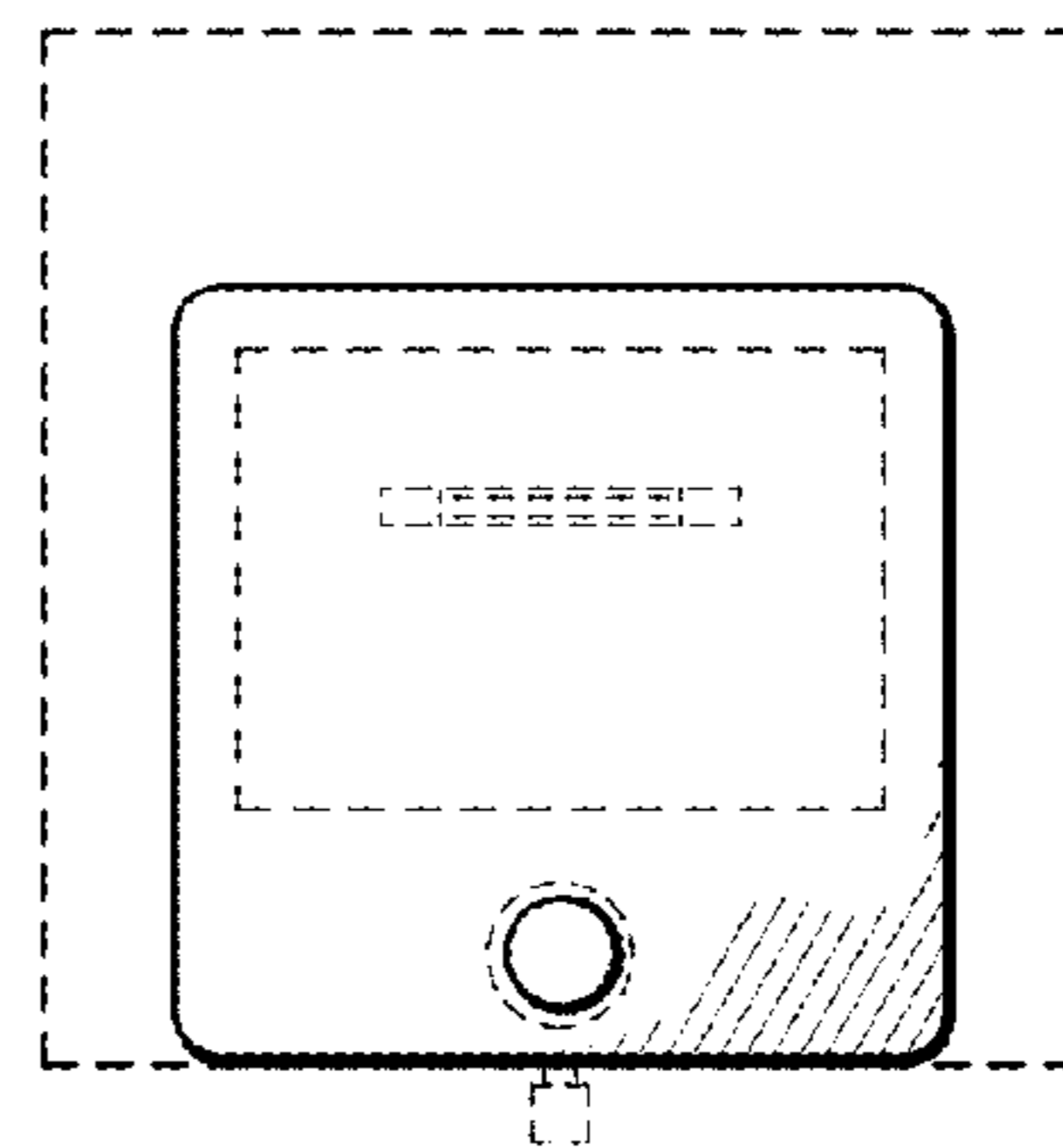

FIG. 3

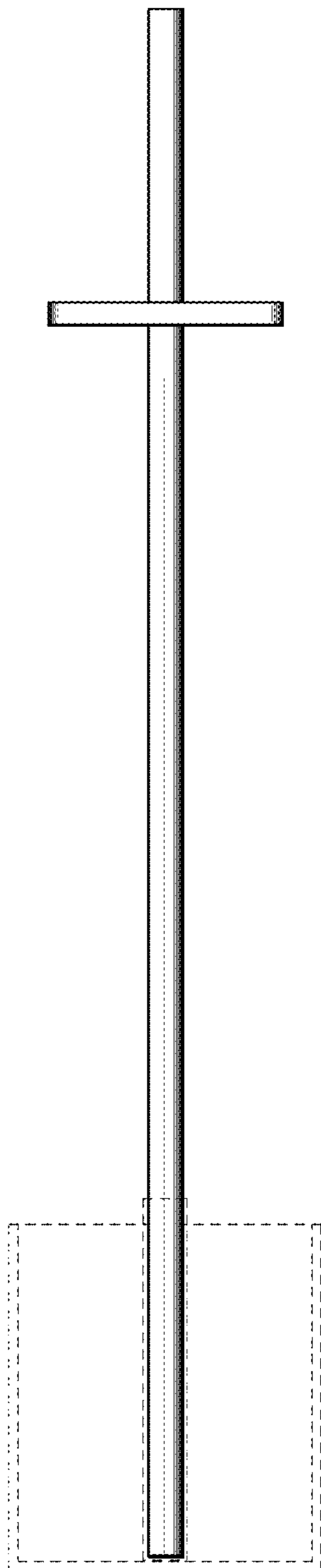

FIG. 4

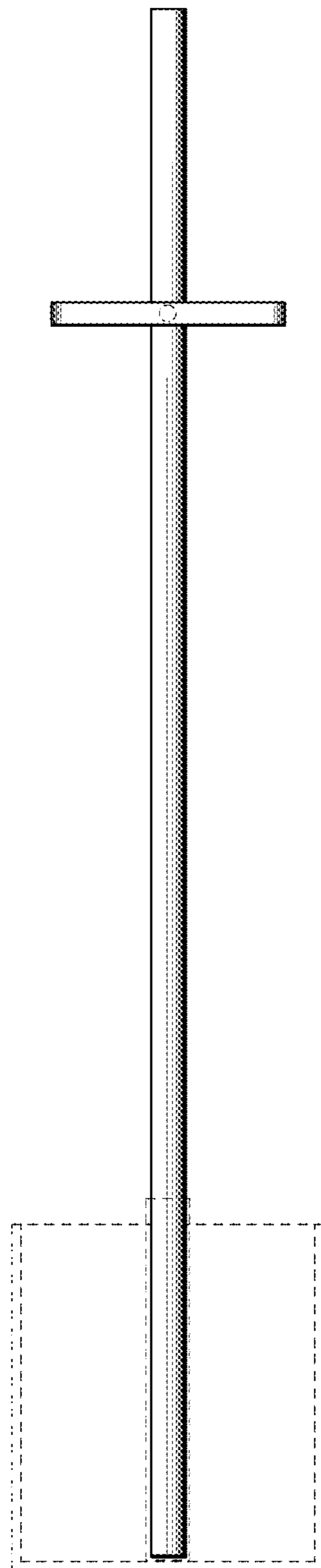

FIG. 5

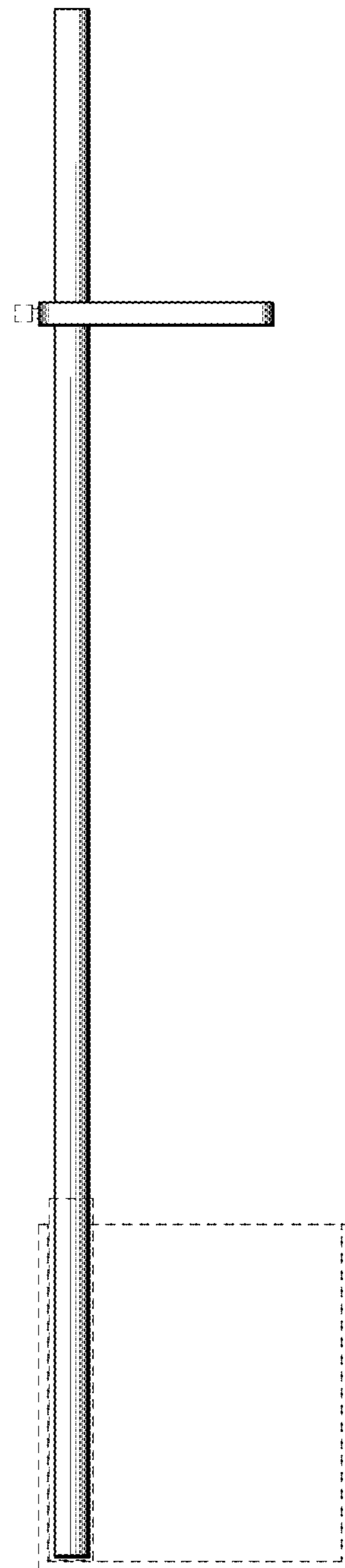

FIG. 6

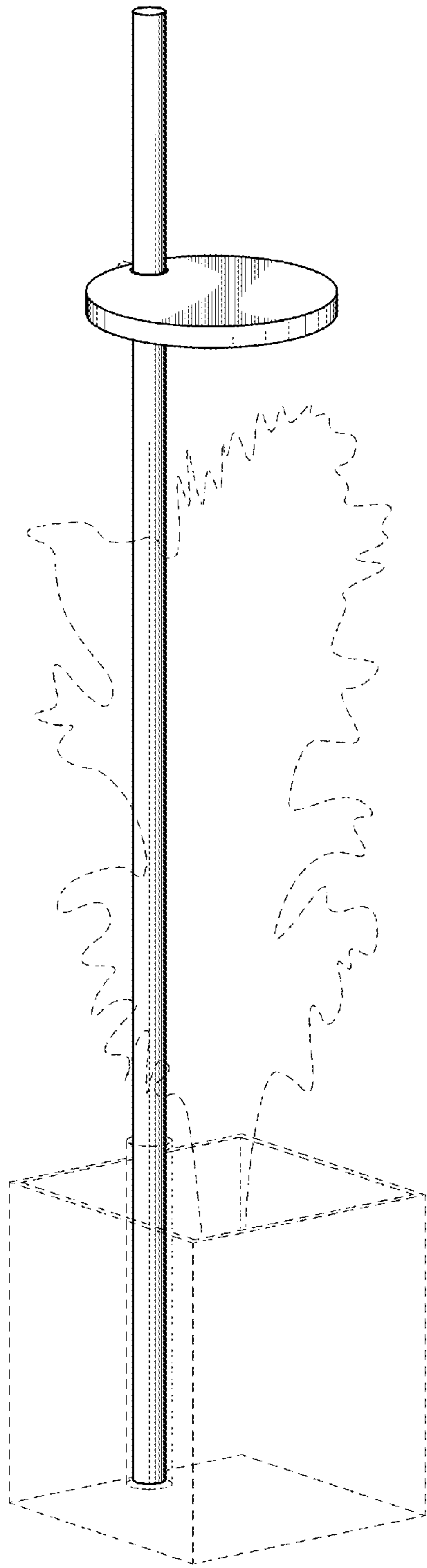

FIG. 7

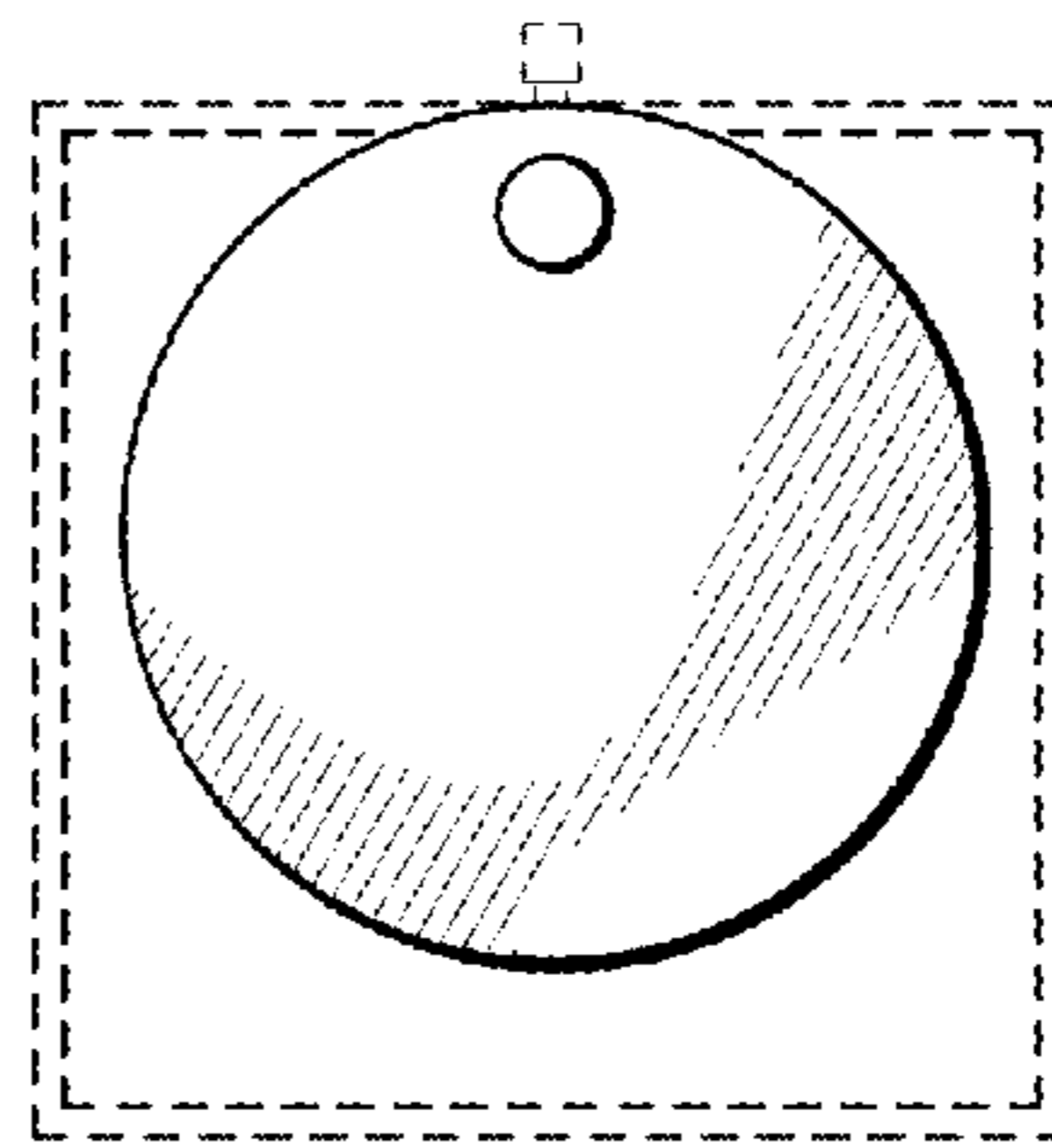

FIG. 8

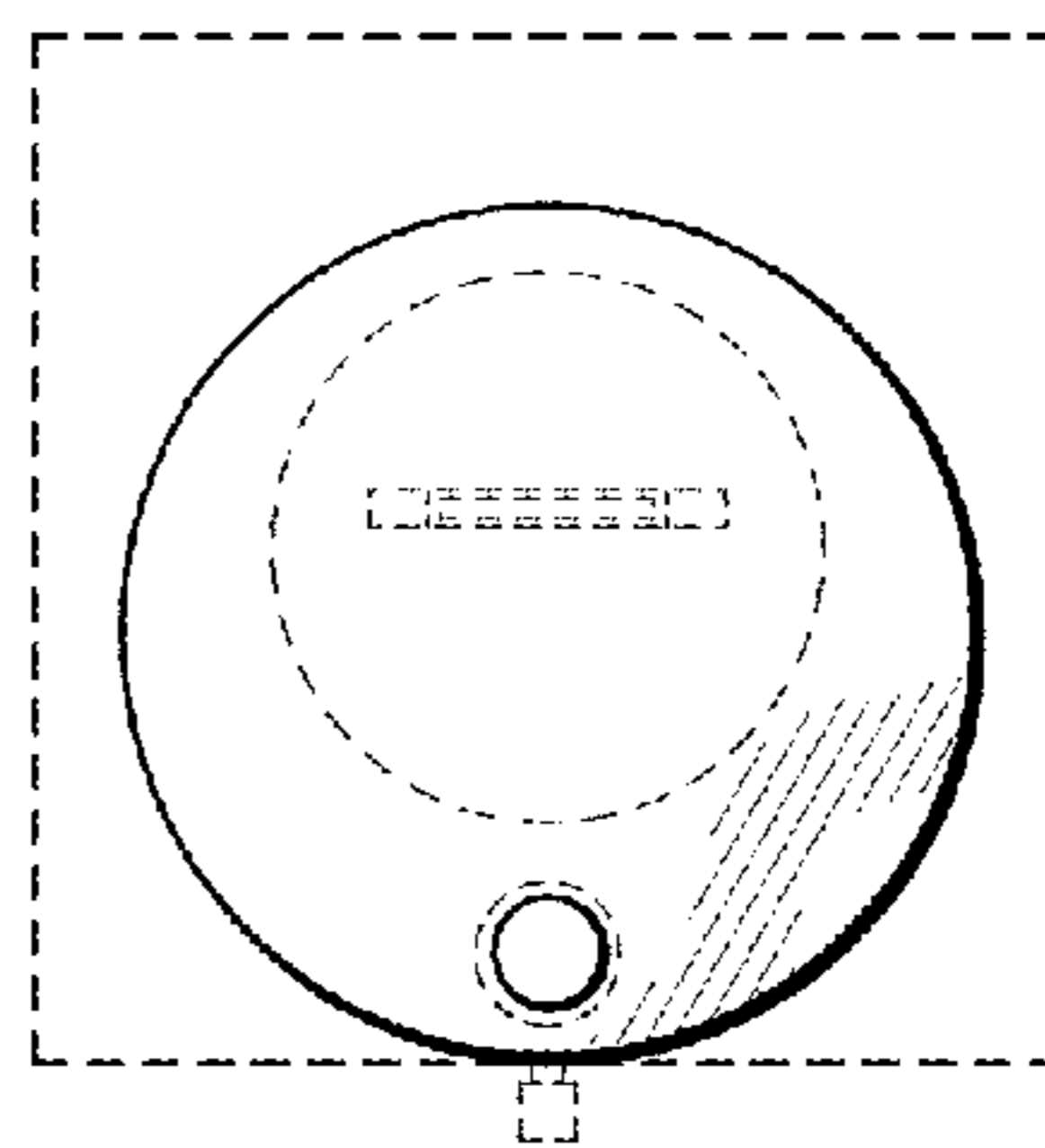

FIG. 9

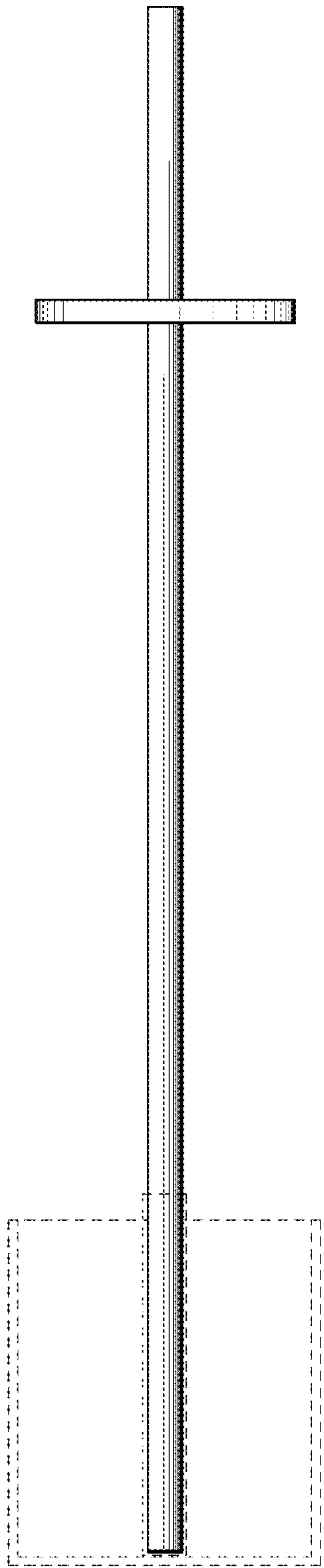

FIG. 10

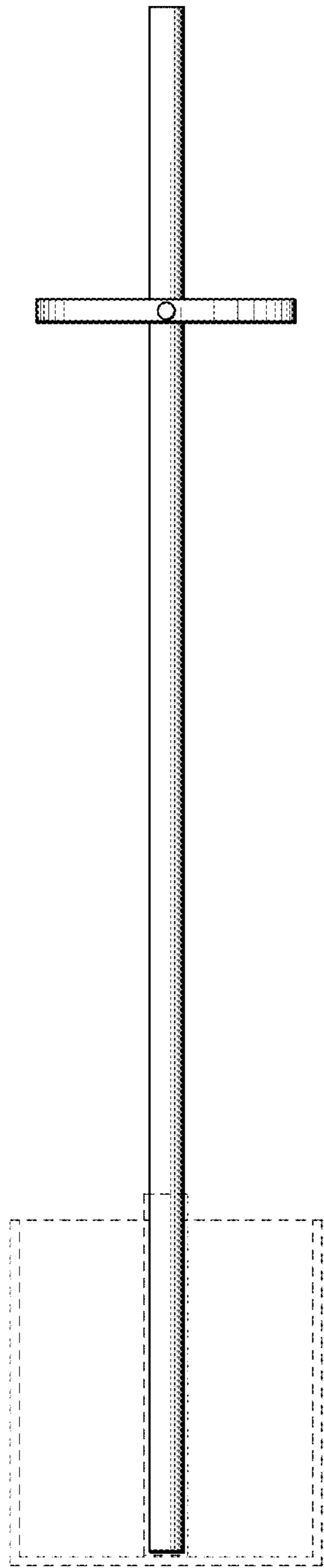

FIG. 11

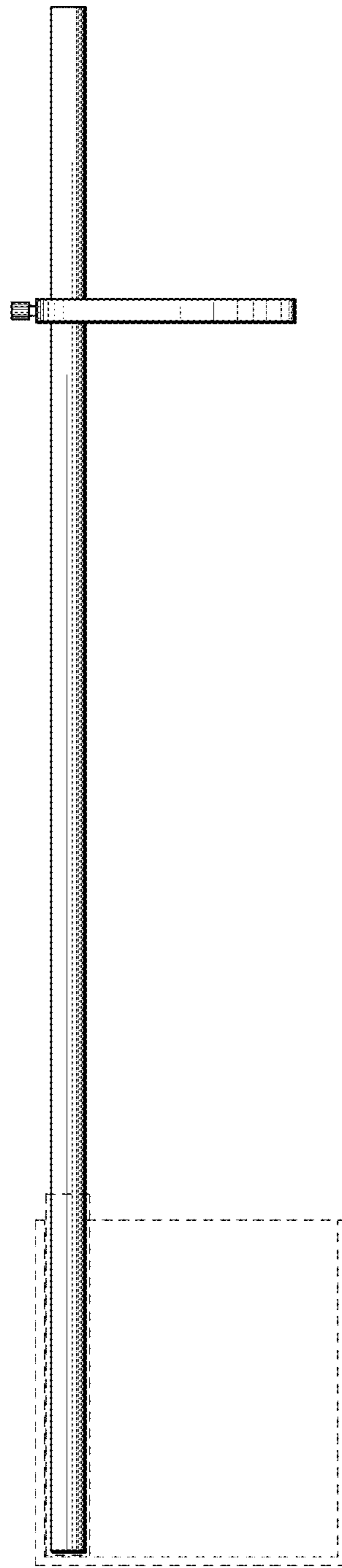

FIG. 12

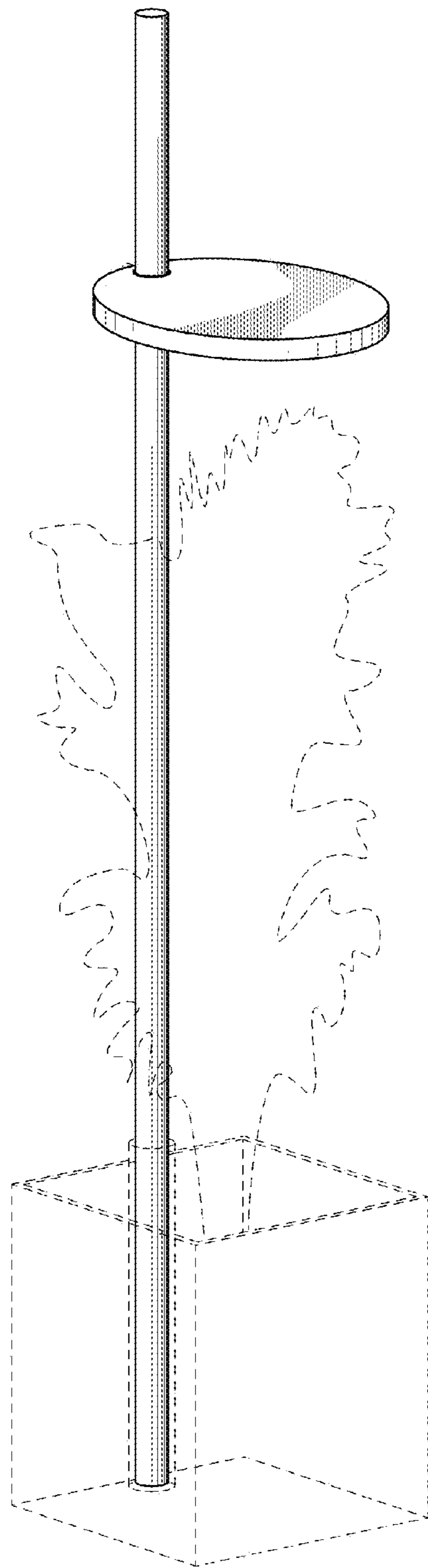

FIG. 13

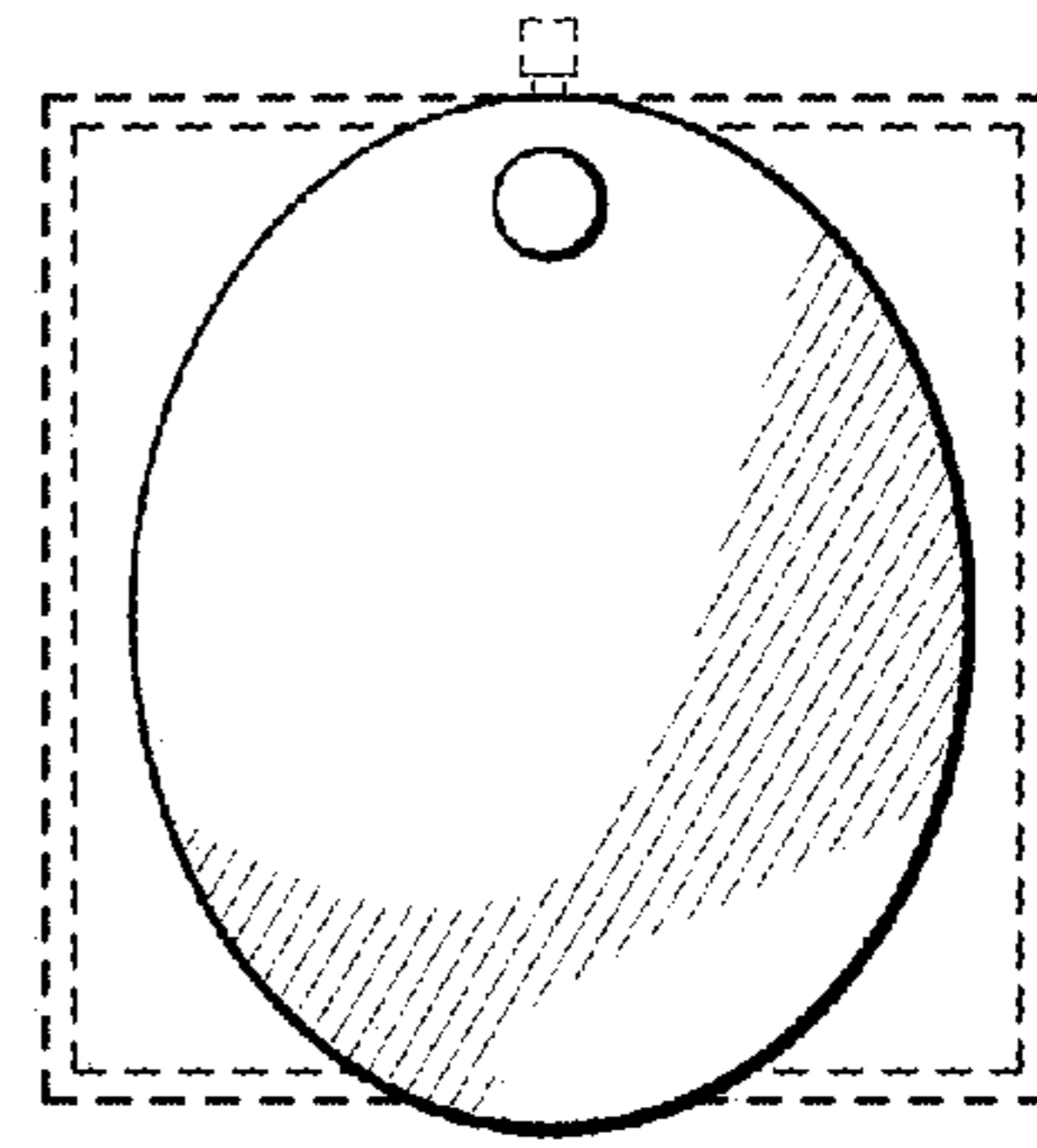

FIG. 14

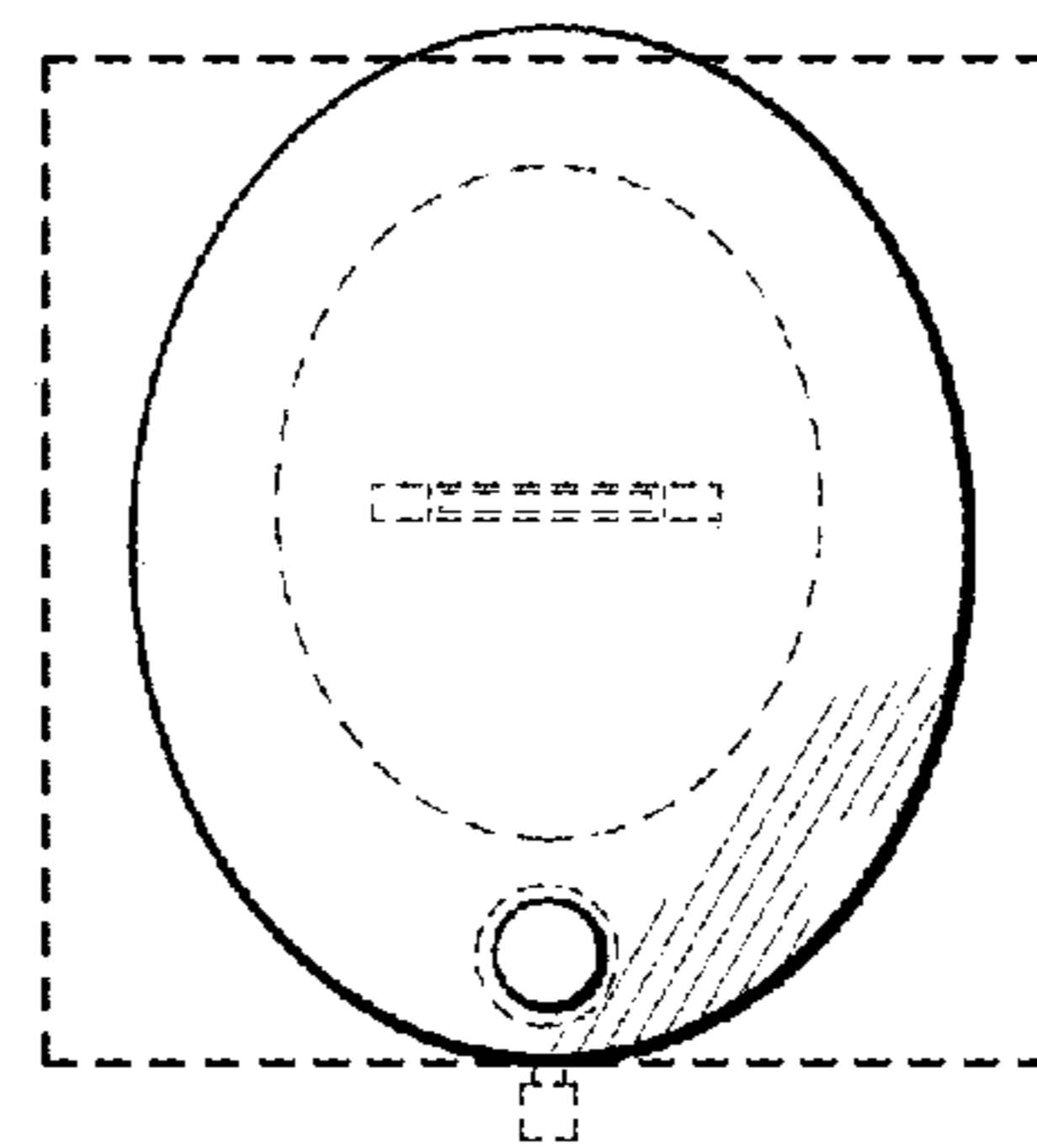

FIG. 15

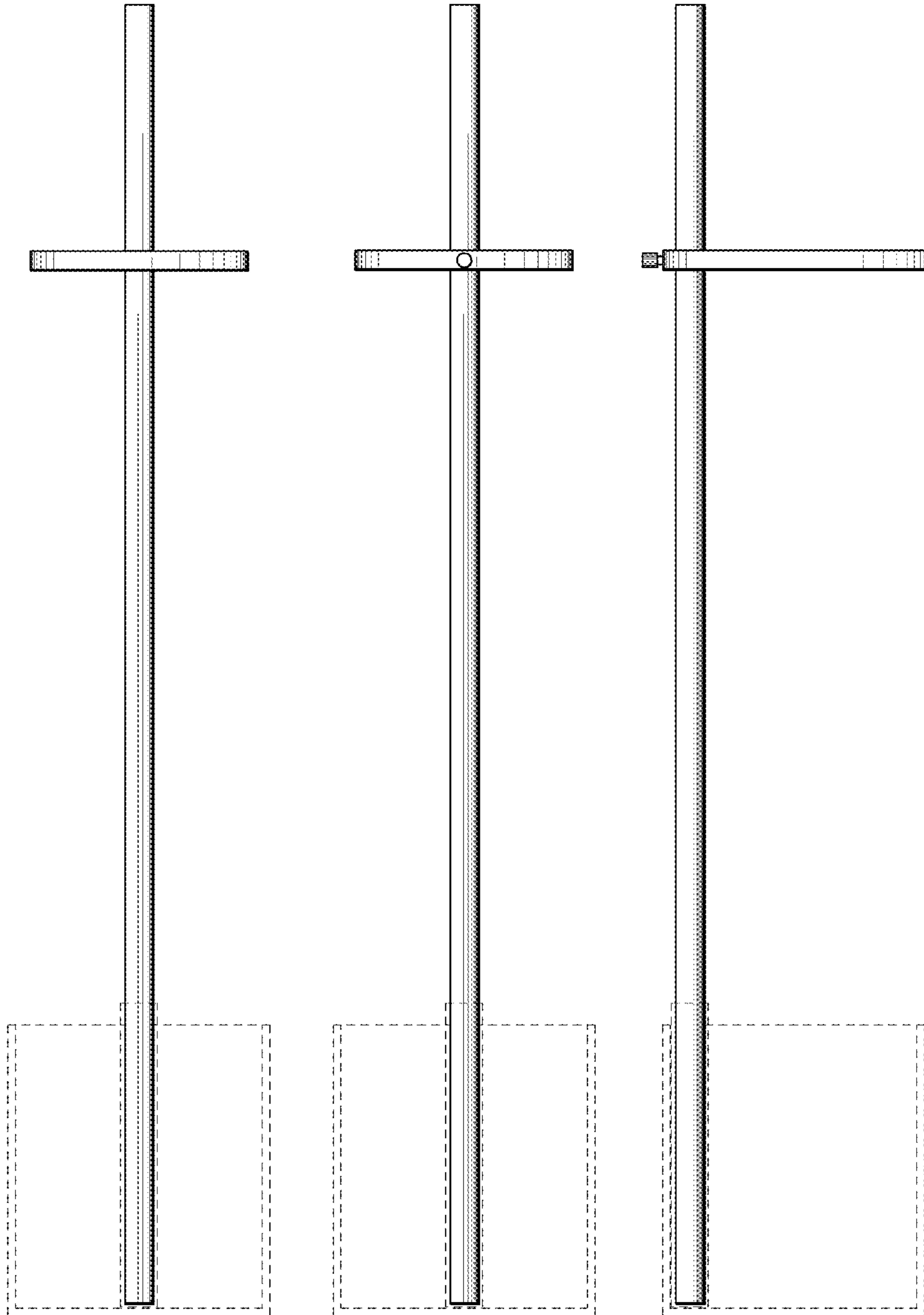

FIG. 16

FIG. 17

FIG. 18