



US00D762898S

(12) **United States Design Patent**
Sugesawa et al.

(10) **Patent No.:** **US D762,898 S**

(45) **Date of Patent:** **** Aug. 2, 2016**

(54) **LIGHT FIXTURE FOR A VEHICLE**

D576,754 S * 9/2008 Wang D26/31
D653,783 S * 2/2012 Biro D26/31
D714,480 S * 9/2014 Law D26/31

(71) Applicants: **CENTRAL JAPAN RAILWAY COMPANY**, Nagoya-shi, Aichi (JP);
NIPPON SHARYO, LTD., Nagoya-shi, Aichi (JP)

* cited by examiner

(72) Inventors: **Masahiro Sugesawa**, Nagoya (JP);
Tomoyuki Fukunaga, Nagoya (JP);
Yoshikazu Sumi, Motosu (JP);
Masayuki Hattori, Motosu (JP);
Kuniharu Matsuda, Osaka (JP); **Akira Nishikawa**, Osaka (JP); **Hiroki Tanaka**, Nagoya (JP); **Hiroyuki Ishikura**, Nagoya (JP)

Primary Examiner — Marcus Jackson

(74) *Attorney, Agent, or Firm* — Oliff PLC

(73) Assignees: **Nippon Sharyo, Ltd**, Nagoya (JP);
Central Japan Railway Company, Nagoya (JP)

(57) **CLAIM**

The ornamental design for a light fixture for a vehicle, as shown and described.

(**) Term: **14 Years**

DESCRIPTION

(21) Appl. No.: **29/521,062**

FIG. 1 is a front elevational view of the light fixture for a vehicle;

(22) Filed: **Mar. 19, 2015**

FIG. 2 is a rear elevational view thereof;

FIG. 3 is a right elevational view thereof;

(30) **Foreign Application Priority Data**

Sep. 19, 2014 (JP) 2014-020850

FIG. 4 is a left elevational view thereof;

FIG. 5 is a top plan view thereof;

FIG. 6 is a bottom plan view thereof;

FIG. 7 is an enlarged view of the area 7 in FIG. 1;

FIG. 8 is an enlarged view of the area 8 in FIG. 1;

FIG. 9 is an enlarged view of the area 9 in FIG. 1;

FIG. 10 is an enlarged view of the area 10 in FIG. 1;

FIG. 11 is an enlarged view of the area 11 in FIG. 2;

FIG. 12 is an enlarged view of the area 12 in FIG. 2;

FIG. 13 is an enlarged view of the area 13 in FIG. 5;

FIG. 14 is a cross-sectional view along line 14 in FIG. 9;

FIG. 15 is a cross-sectional view along line 15 in FIG. 10; and,

FIG. 16 is a cross-sectional view along line 16 in FIG. 7.

The broken lines depict environmental subject matter only and form no part of the claimed design. The dot-dot-dash chain lines indicate enlargement areas and form no part of the claimed design. The appearance of the portion of the article between the bracketed break forms no part of the claimed design.

(51) **LOC (10) Cl.** **26-06**

(52) **U.S. Cl.**
USPC **D26/31**

(58) **Field of Classification Search**
USPC D26/28–36; 362/61, 80–83, 267–269,
362/459–468, 475–478, 485–487
CPC F21S 48/00; F21S 48/10; F21S 48/115;
F21S 48/225; F21S 48/1233; F21S 48/1266;
F21S 48/1388; F21S 48/2268; F21V 21/04
See application file for complete search history.

(56) **References Cited**

U.S. PATENT DOCUMENTS

D526,430 S * 8/2006 Hernandez D26/31

1 Claim, 9 Drawing Sheets

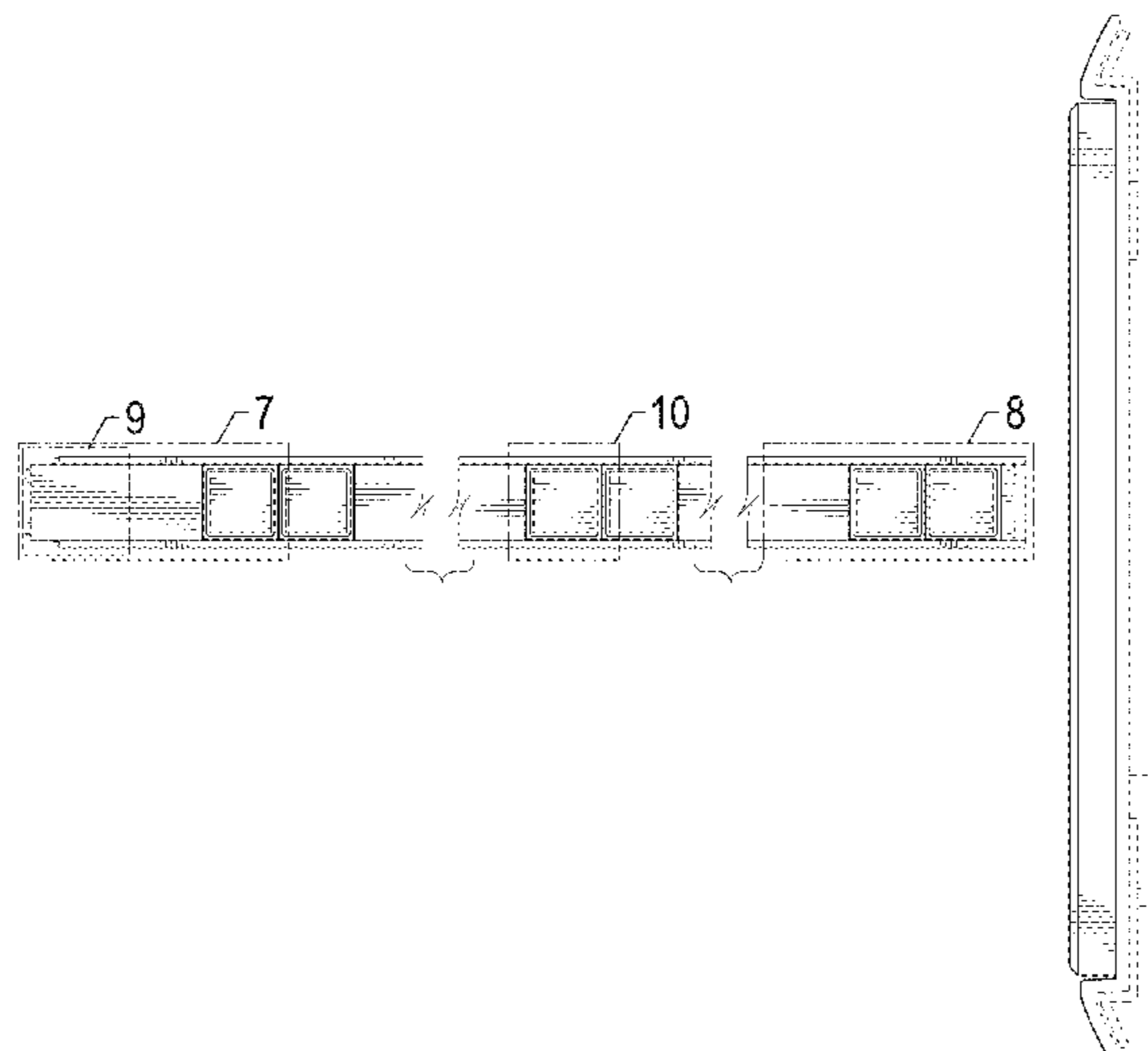

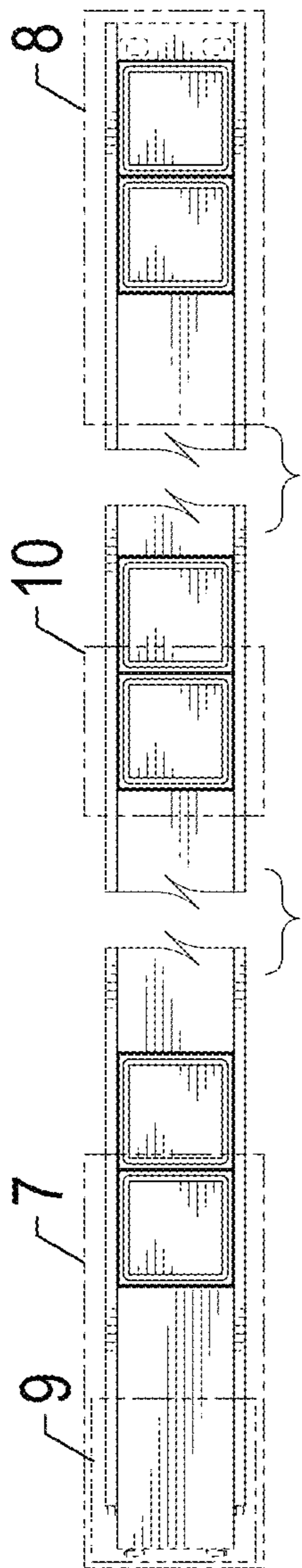

FIG. 1

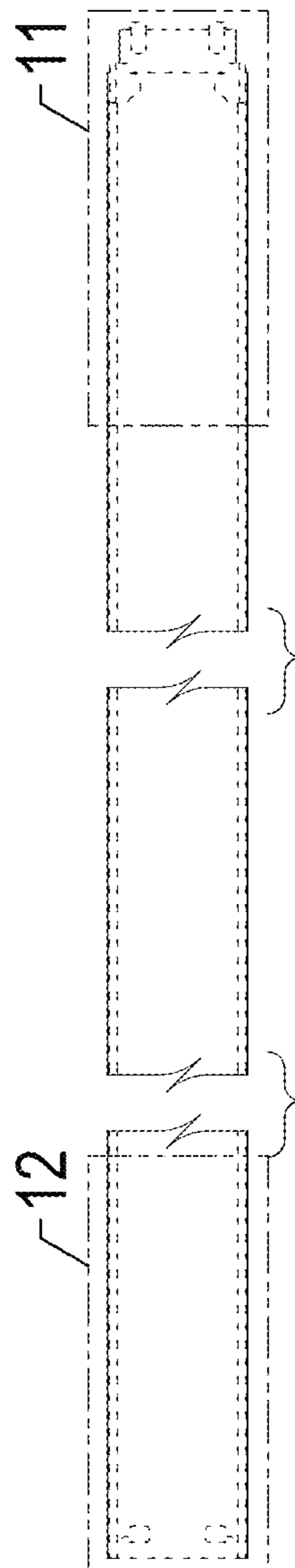

FIG. 2

FIG. 4

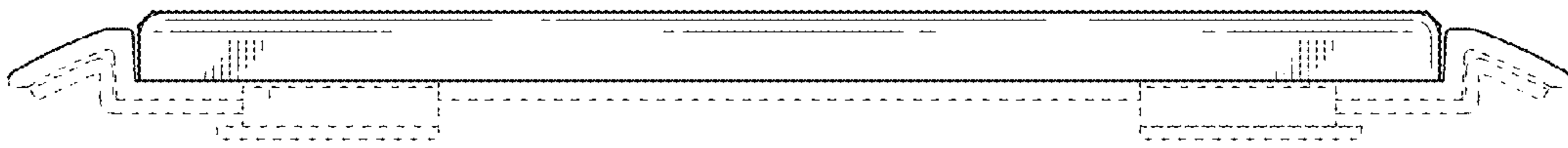
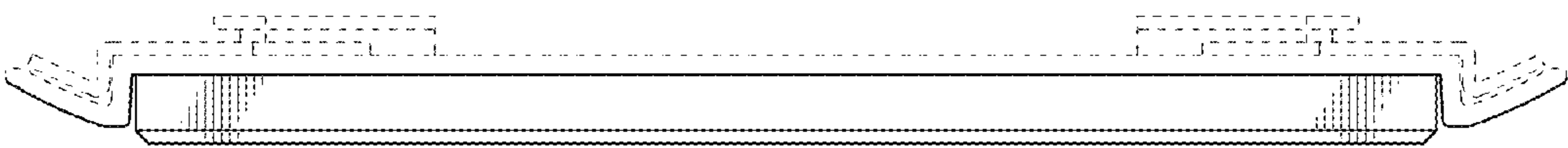

FIG. 3



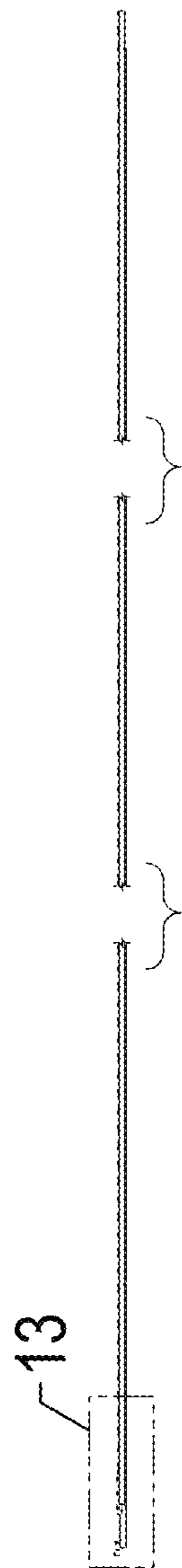

FIG. 5

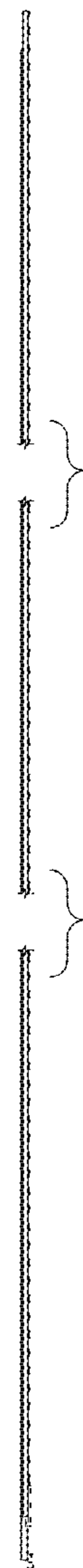

FIG. 6

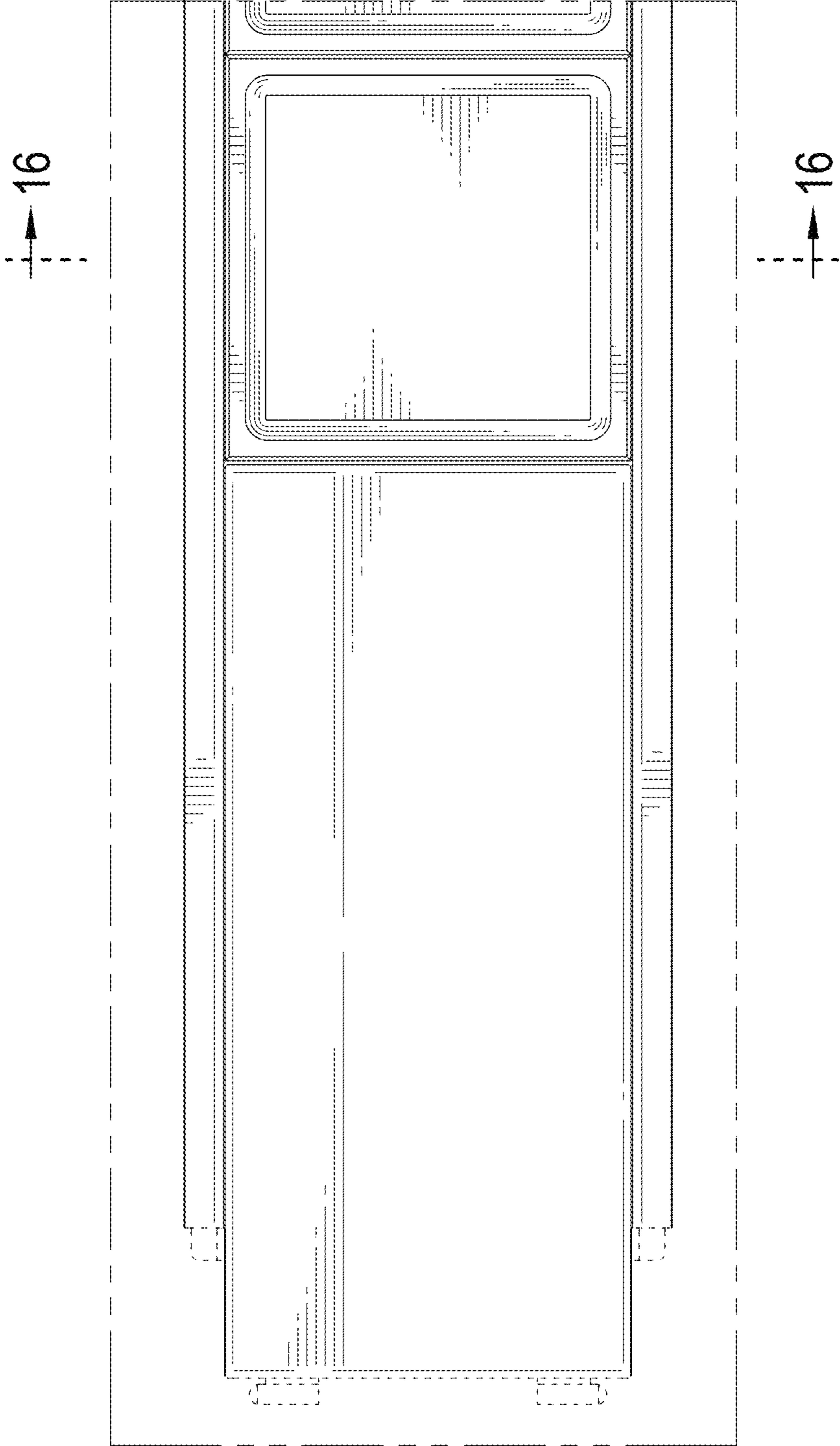

FIG. 7

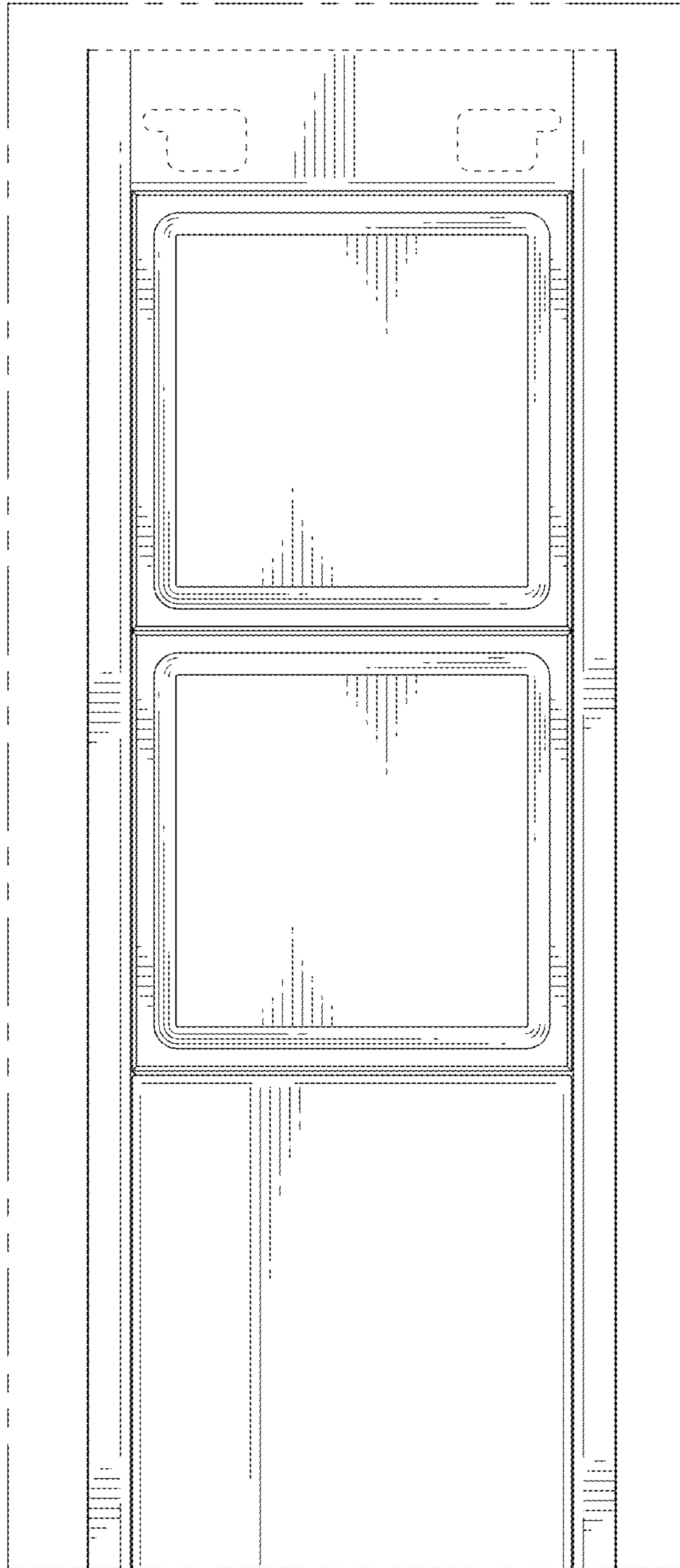

FIG. 8

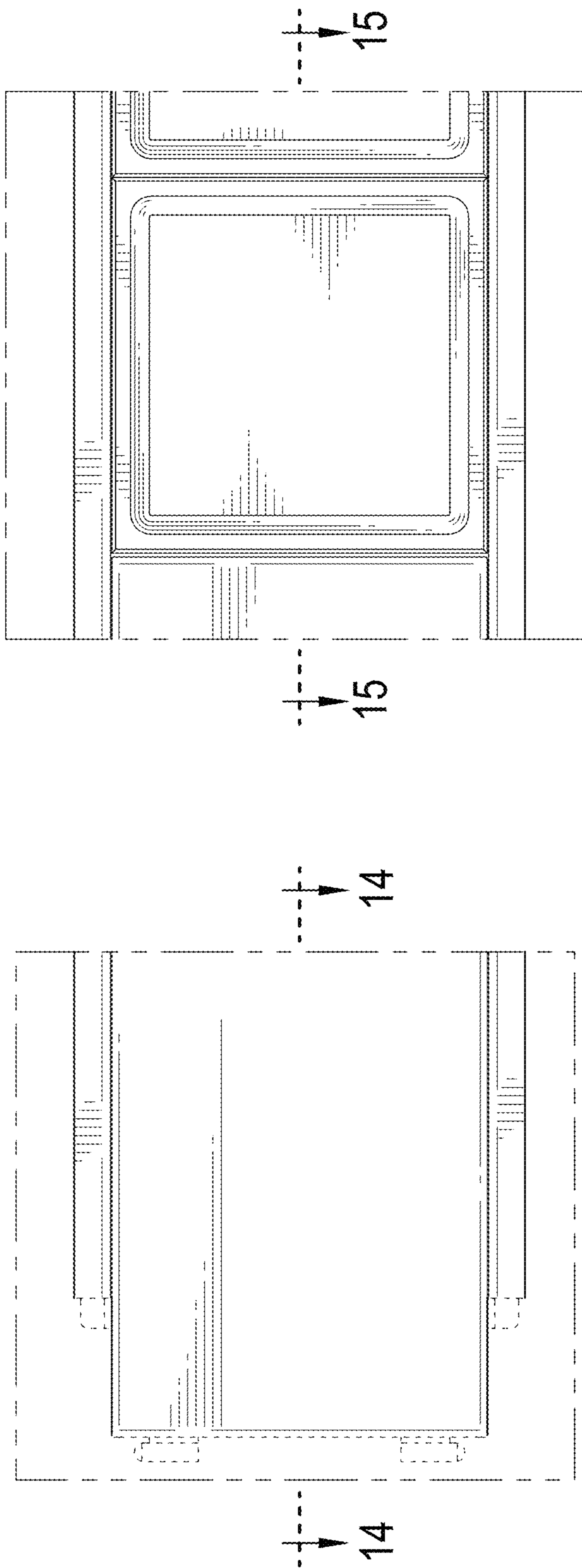

FIG. 10

FIG. 9

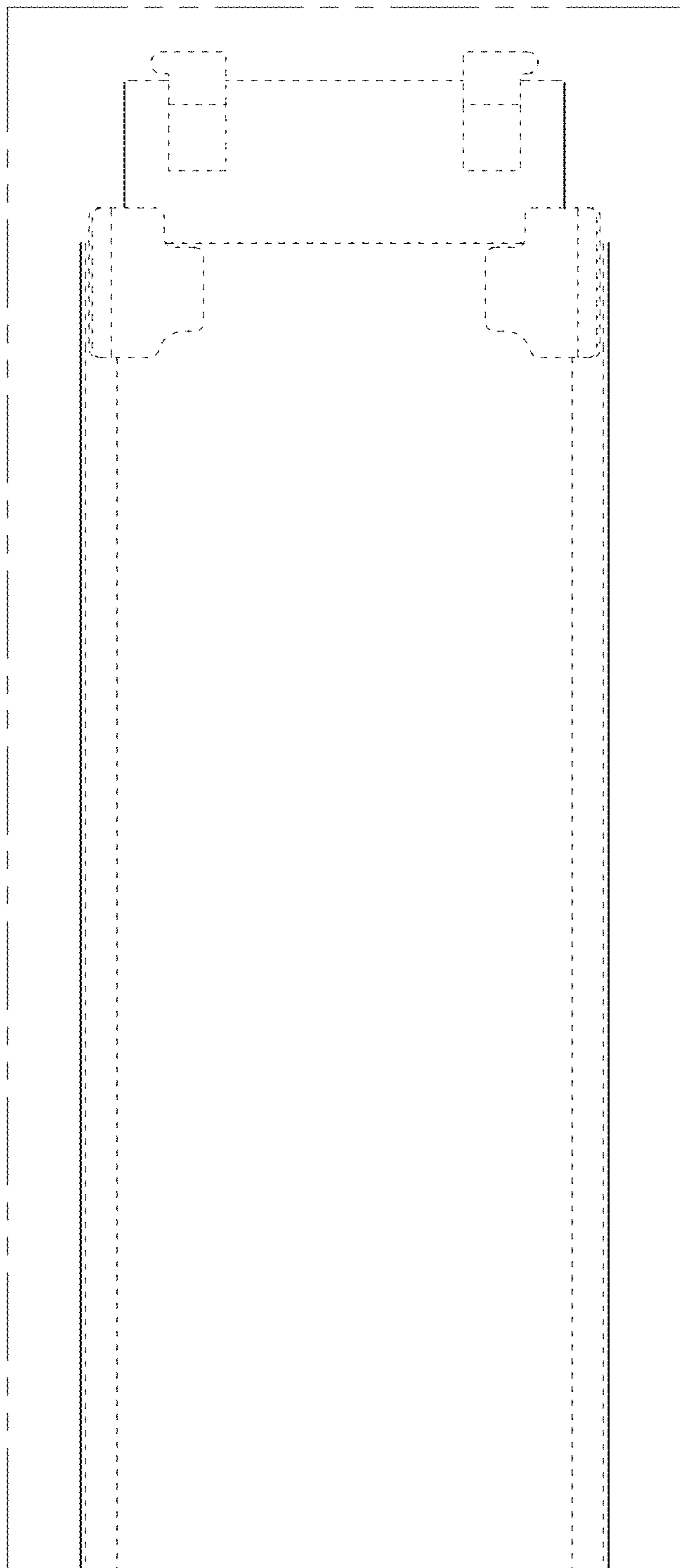

FIG. 11

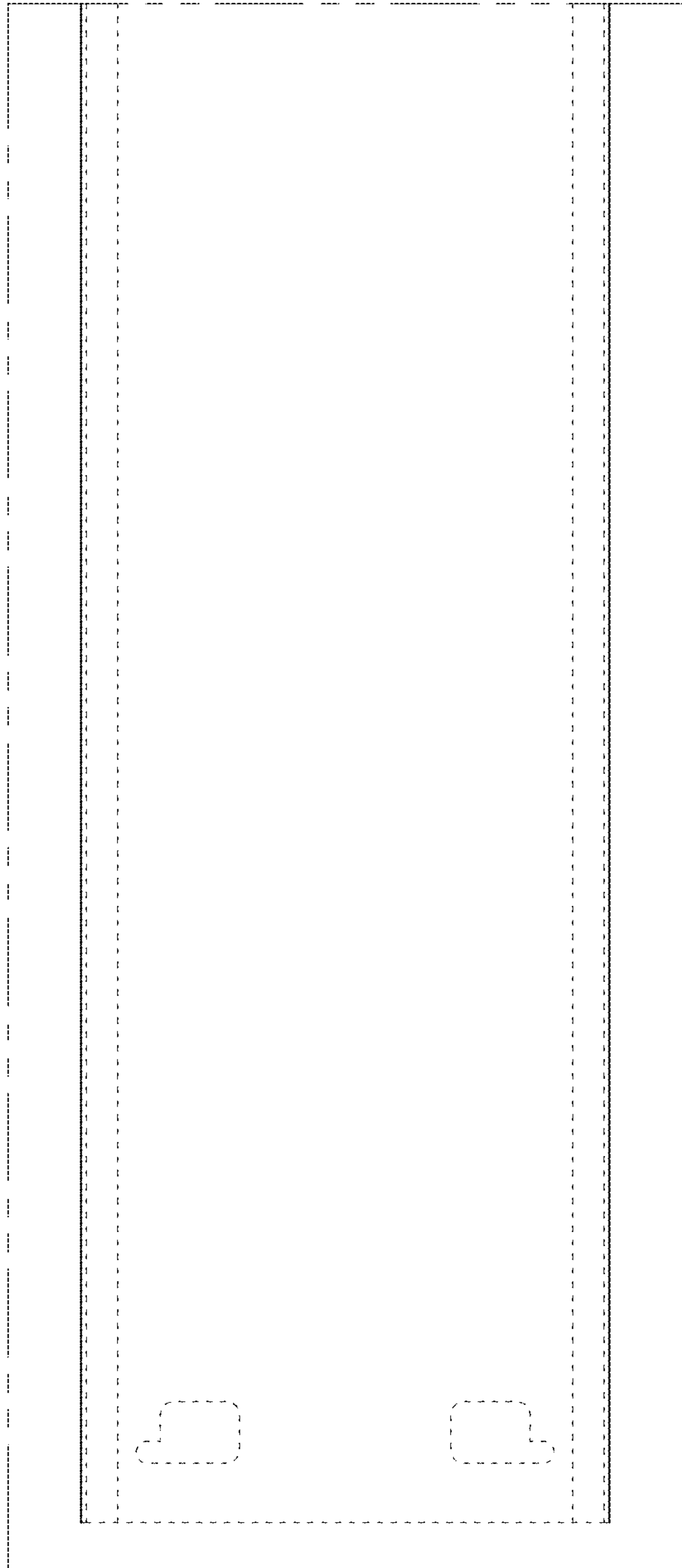

FIG. 12

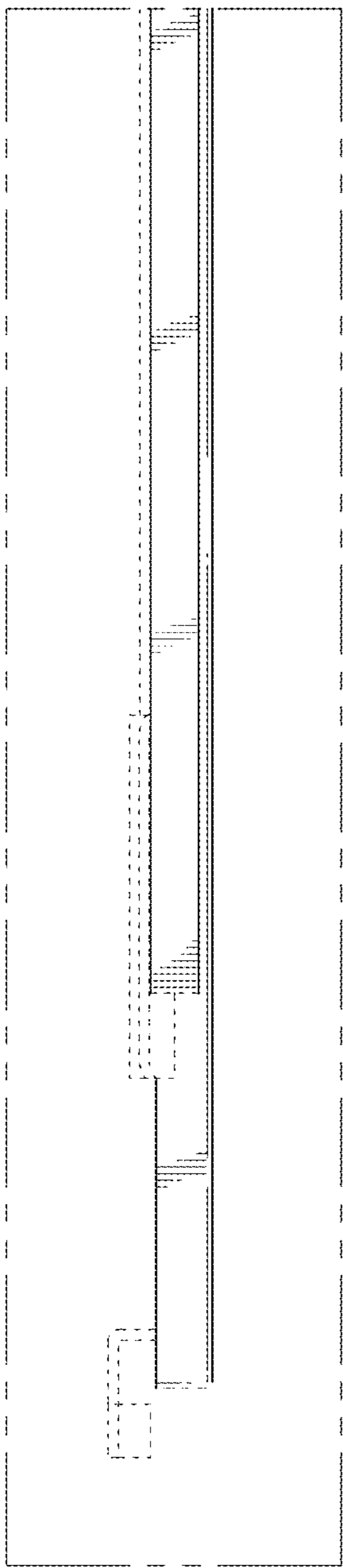

FIG. 13

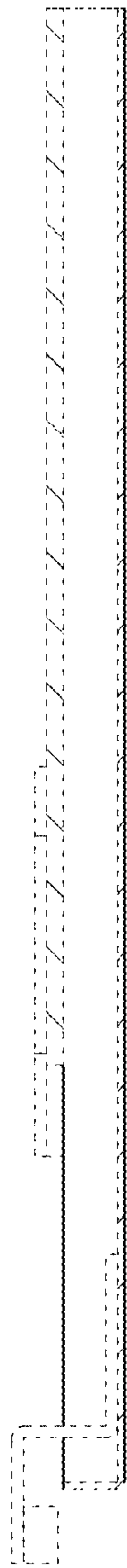

FIG. 14

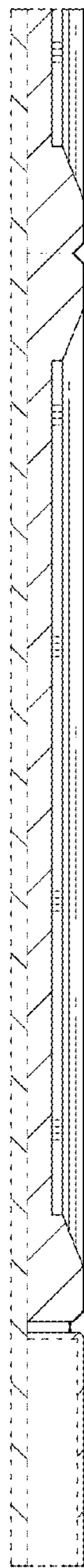

FIG. 15

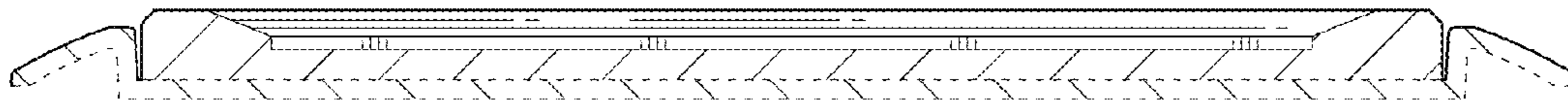

FIG. 16