



US00D762850S

(12) **United States Design Patent**
Harr et al.

(10) **Patent No.:** **US D762,850 S**
(45) **Date of Patent:** **** Aug. 2, 2016**

- (54) **CASSETTE**
- (71) Applicant: **Covidien LP**, Mansfield, MA (US)
- (72) Inventors: **James M. Harr**, Wentzville, MO (US);
Joel D. Wiesner, St. Peters, MO (US);
Kenneth M. Breitweiser, Brighton, IL (US)
- (73) Assignee: **Covidien LP**, Mansfield, MA (US)
- (**) Term: **14 Years**
- (21) Appl. No.: **29/452,920**
- (22) Filed: **Apr. 23, 2013**
- (51) **LOC (10) Cl.** **24-01**
- (52) **U.S. Cl.**
USPC **D24/129**
- (58) **Field of Classification Search**
USPC D24/127–131, 112–114, 133, 186, 118;
606/181, 185; 604/264, 272, 115, 232,
604/187, 158, 164.08, 192, 263, 163, 181,
604/184, 198, 227, 332, 333, 151; 600/101,
600/139, 143; 128/200.24, 207.14, 207.15,
128/DIG. 24; 417/477.2
CPC A61M 5/14232; F04B 43/1253; F04B
43/1269; F04B 43/1223
See application file for complete search history.

5,096,393 A	3/1992	Van Steenderen et al.	
5,256,041 A	10/1993	Tucker	
5,470,211 A	11/1995	Knott et al.	
5,655,897 A	8/1997	Nefel et al.	
5,927,956 A	7/1999	Lim et al.	
5,971,726 A	10/1999	Yoshida et al.	
6,027,459 A *	2/2000	Shain et al.	600/573
6,062,829 A	5/2000	Ognier	
D437,058 S *	1/2001	Gozani	D24/186
D456,509 S *	4/2002	Schultz	D24/133
D479,325 S *	9/2003	Tyce	D24/114
6,736,617 B2	5/2004	Domroese	
7,092,797 B2	8/2006	Gaines et al.	
D562,985 S *	2/2008	Brefka et al.	D24/186
7,374,545 B2 *	5/2008	Alroy	600/583
7,534,099 B2	5/2009	Knauper et al.	
7,608,059 B2	10/2009	Harr et al.	

(Continued)

FOREIGN PATENT DOCUMENTS

FR 2598182 A1 11/1987
Primary Examiner — David Muller
Assistant Examiner — Nathan Johnston

(57) **CLAIM**
 The ornamental design for a cassette, as shown and described.

DESCRIPTION

FIG. 1 is a front perspective view of a cassette;
 FIG. 2 is a front elevation view thereof;
 FIG. 3 is a right side elevation view thereof;
 FIG. 4 is a left side elevation view thereof;
 FIG. 5 is a rear side elevation view thereof;
 FIG. 6 is a top plan view thereof; and,
 FIG. 7 is a bottom plan view thereof.
 The dash dot lines immediately adjacent to the claimed areas in FIG. 7 represent the boundaries of the claimed design. The dashed lines in the figures illustrate the portions of the design that form no part of the claimed design. None of the broken lines form any part of the claimed design.

1 Claim, 6 Drawing Sheets

- (56) **References Cited**
- U.S. PATENT DOCUMENTS
- | | | |
|-------------|---------|-------------------|
| 3,353,491 A | 11/1967 | Bastian |
| 3,597,124 A | 8/1971 | Adams |
| 4,138,205 A | 2/1979 | Wallach |
| 4,545,744 A | 10/1985 | Weber et al. |
| 4,558,996 A | 12/1985 | Becker |
| 4,559,040 A | 12/1985 | Horres et al. |
| 4,650,471 A | 3/1987 | Tamari |
| 4,666,598 A | 5/1987 | Heath et al. |
| 4,886,431 A | 12/1989 | Soderquist et al. |
| 4,976,590 A | 12/1990 | Baldwin |

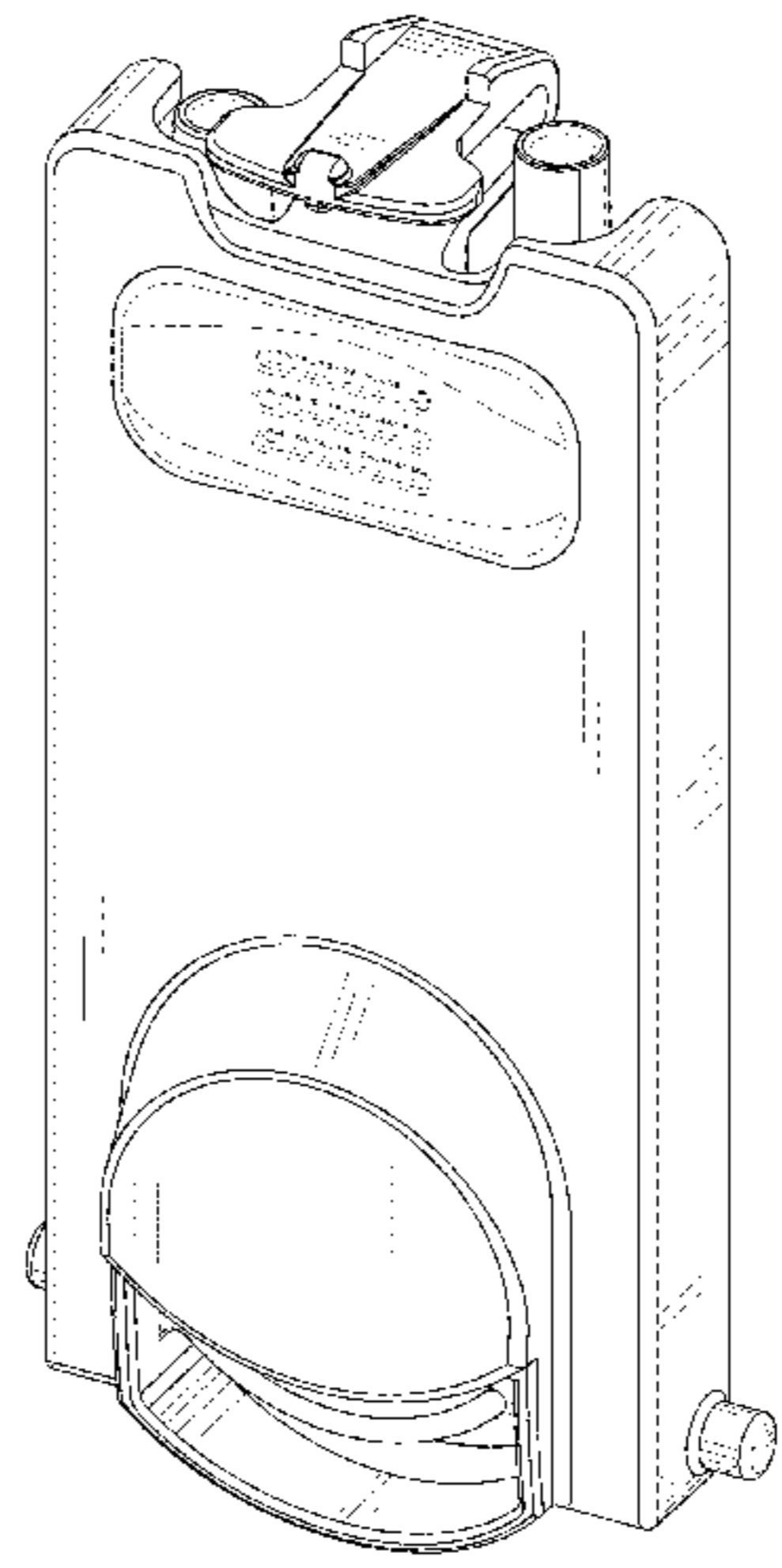

(56)

References Cited

U.S. PATENT DOCUMENTS

D603,968 S *	11/2009	Brefka	D24/186	2005/0069436 A1	3/2005	Shibasaki	
7,722,338 B2	5/2010	Nordell et al.		2006/0067845 A1	3/2006	Kojima et al.	
7,934,912 B2	5/2011	Voltenburg, Jr. et al.		2007/0217932 A1	9/2007	Voyeux et al.	
8,043,077 B2	10/2011	Miyazaki		2008/0112828 A1	5/2008	Muri et al.	
8,047,819 B2	11/2011	Lawrence et al.		2009/0053085 A1	2/2009	Thompson et al.	
8,128,382 B2	3/2012	Smits		2010/0129247 A1	5/2010	Lauer	
8,197,236 B2	6/2012	McIntosh		2010/0129248 A1	5/2010	Mou	
D664,258 S *	7/2012	Harkin et al.	D24/186	2010/0301071 A1	12/2010	Alstad et al.	
8,262,616 B2 *	9/2012	Grant et al.	604/151	2011/0286870 A1	11/2011	Bach	
8,353,683 B2	1/2013	Miyazaki et al.		2011/0313358 A1	12/2011	Hariharsan et al.	
8,545,198 B2	10/2013	Artsyukhovich et al.		2012/0034117 A1	2/2012	Pfouts et al.	
8,550,310 B2	10/2013	Alstad et al.		2012/0083735 A1	4/2012	Pfouts	
D697,626 S *	1/2014	Laplante et al.	D24/186	2012/0130309 A1	5/2012	Hariharsan et al.	
D715,924 S *	10/2014	Green	D24/127	2012/0143151 A1 *	6/2012	Low et al.	604/263
2002/0131881 A1	9/2002	Kagawa et al.		2012/0195777 A1	8/2012	Stejskal et al.	
2004/0057856 A1	3/2004	Saxer et al.		2013/0071272 A1	3/2013	Juretich et al.	
				2013/0280104 A1	10/2013	Heide et al.	
				2014/0135731 A1 *	5/2014	Breitweiser et al.	604/500

* cited by examiner

FIG. 1

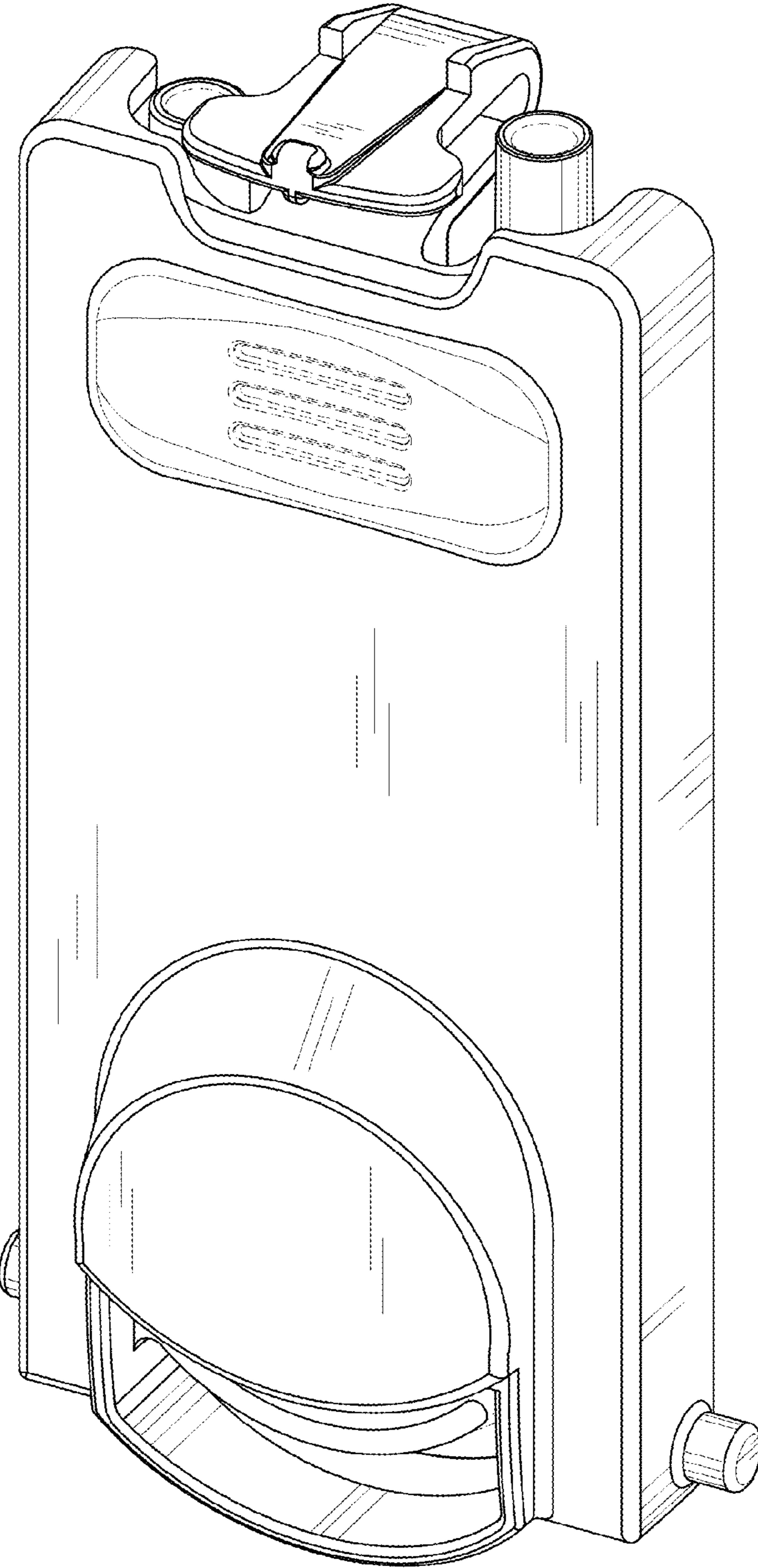

FIG. 2

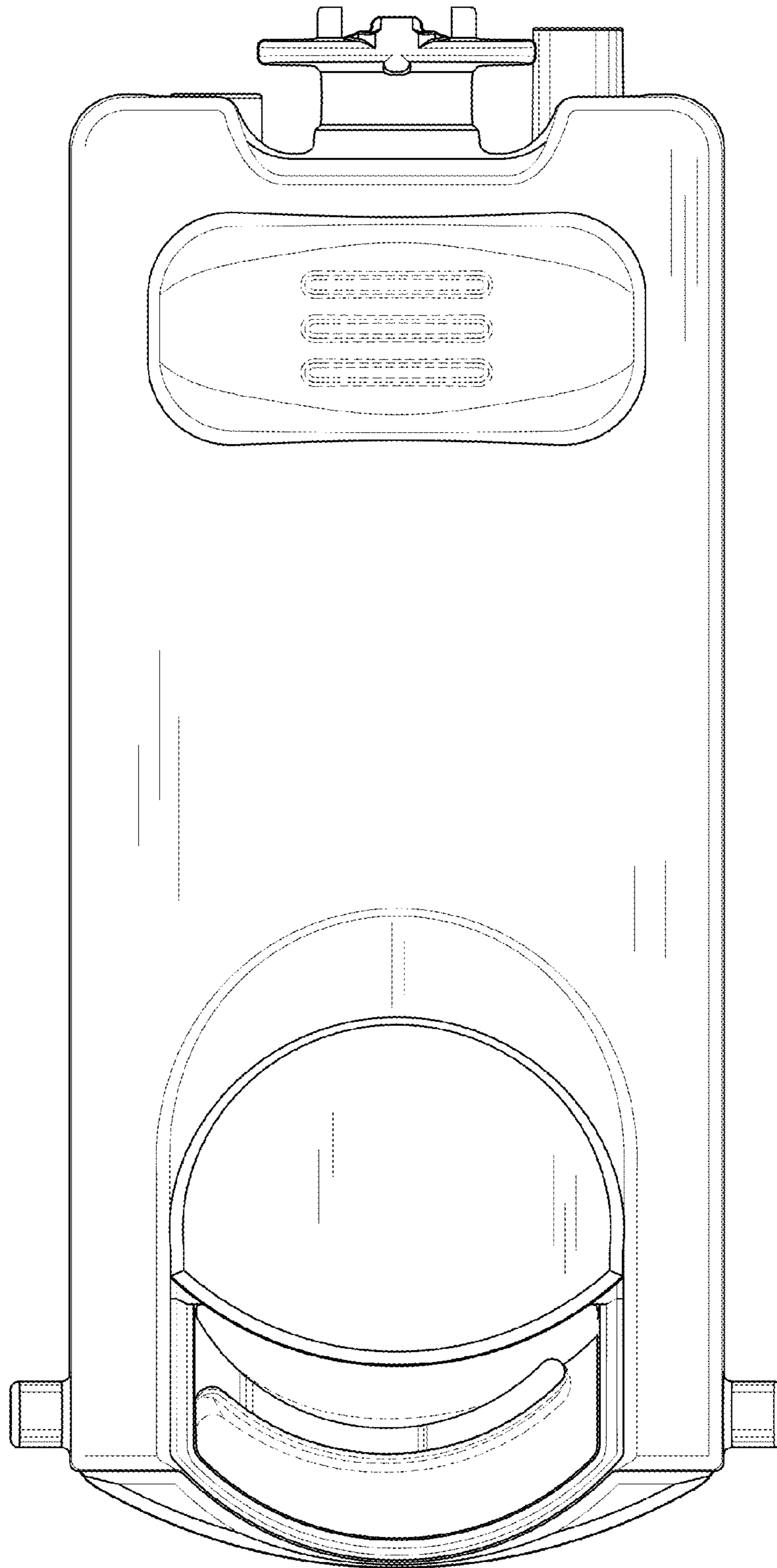

FIG. 3

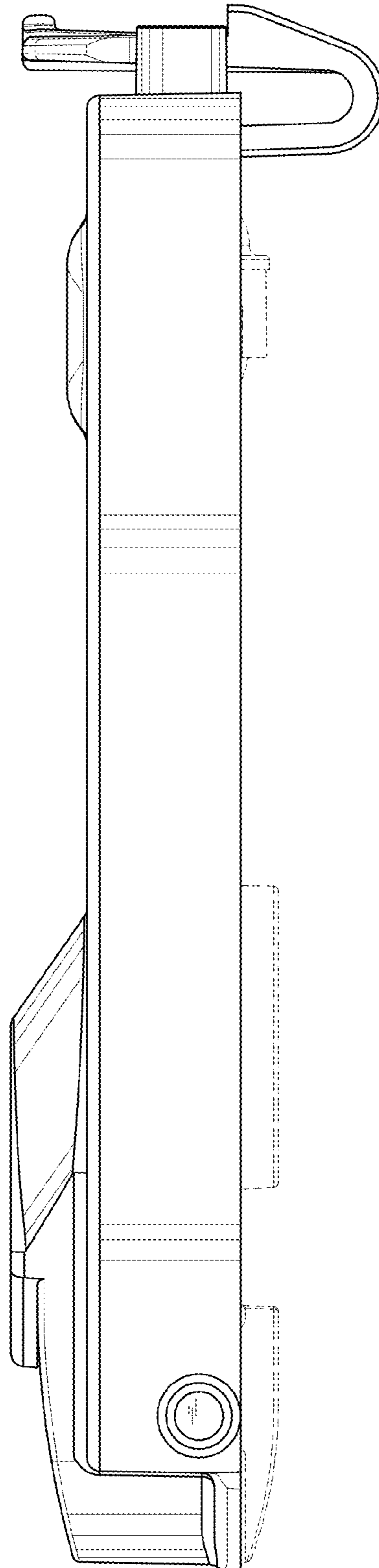

FIG. 4

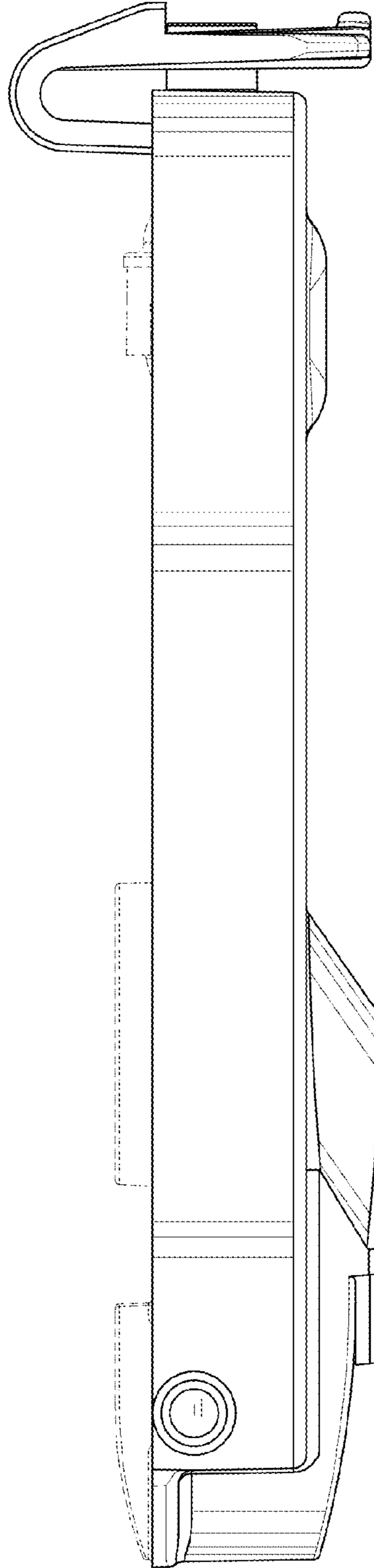

FIG. 5

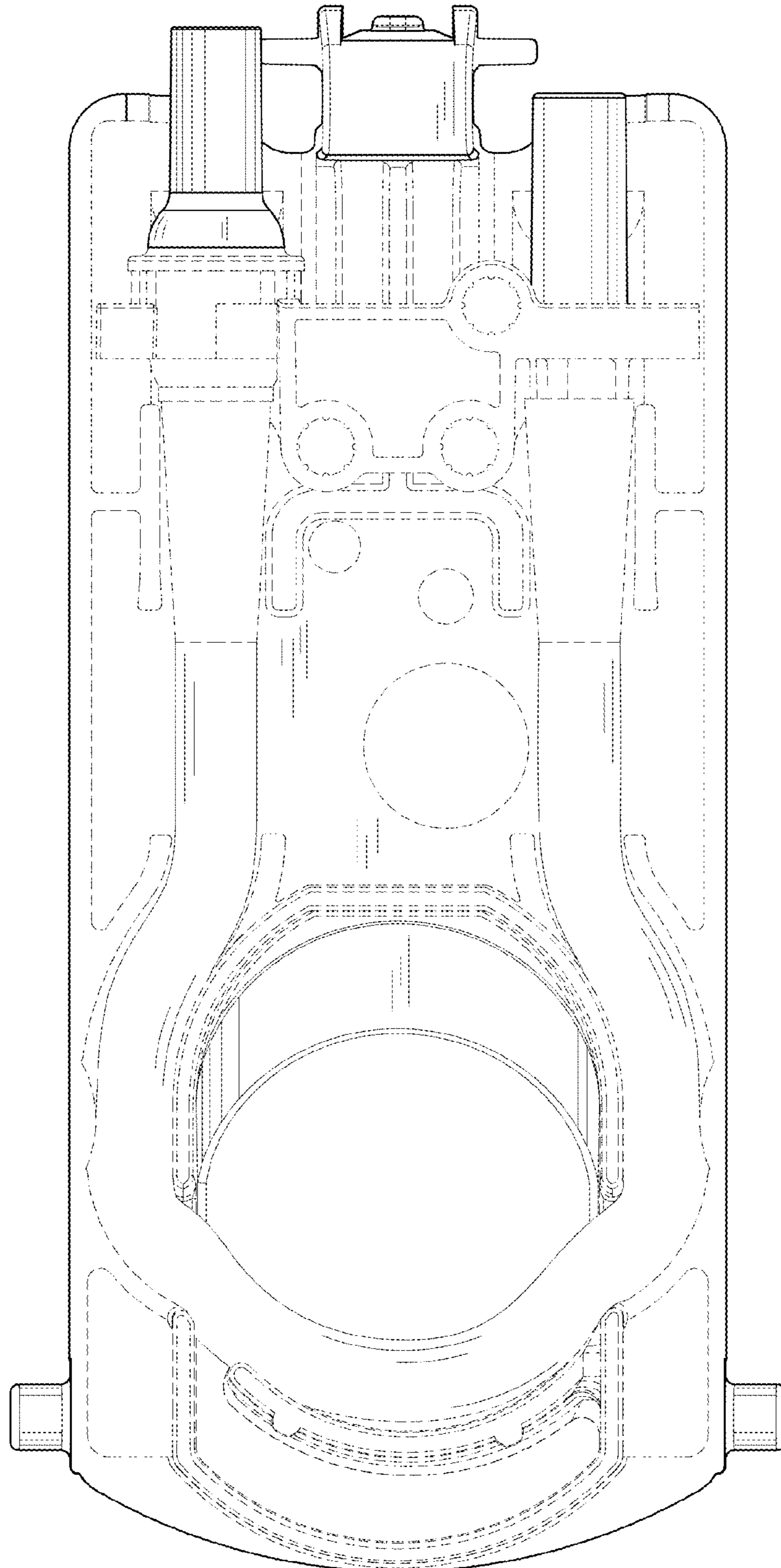

FIG. 6

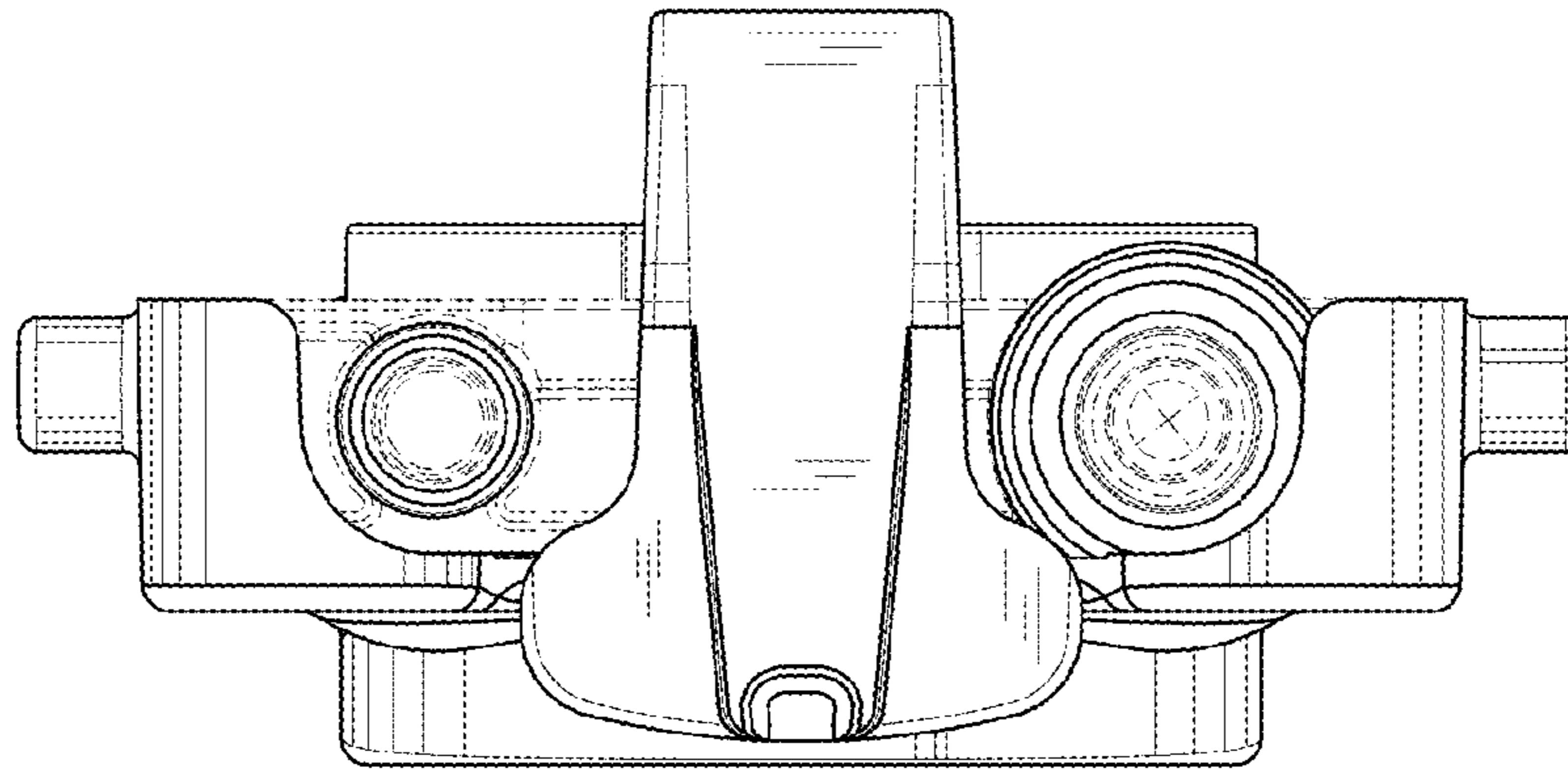

FIG. 7

