



US00D762805S

(12) **United States Design Patent**  
**Serbu**

(10) **Patent No.:** **US D762,805 S**

(45) **Date of Patent:** **\*\* Aug. 2, 2016**

(54) **FIREARM BUTTSTOCK**

(71) Applicant: **Mark Serbu**, Tampa, FL (US)

(72) Inventor: **Mark Serbu**, Tampa, FL (US)

(73) Assignee: **Mark Serbu**, Tampa, FL (US)

(\*\*) Term: **14 Years**

(21) Appl. No.: **29/513,945**

(22) Filed: **Jan. 7, 2015**

(51) **LOC (10) Cl.** ..... **22-01**

(52) **U.S. Cl.**  
USPC ..... **D22/108**

(58) **Field of Classification Search**  
USPC ..... D22/103, 108; D21/571-575  
CPC ..... F41C 23/04; F41C 23/14; F41C 23/06;  
F41C 23/22; F41C 33/007  
See application file for complete search history.

(56) **References Cited**

**U.S. PATENT DOCUMENTS**

D640,342 S *	6/2011	Fitzpatrick	.....	D22/108
D668,311 S *	10/2012	Rogers	.....	D22/108
D683,808 S *	6/2013	Elkaim	.....	D22/108
D688,768 S *	8/2013	Fitzpatrick	.....	D22/108

D691,234 S *	10/2013	Fitzpatrick	.....	D22/108
D692,087 S *	10/2013	Fitzpatrick	.....	D22/108
D692,514 S *	10/2013	Vera	.....	D22/108
D701,281 S *	3/2014	Cottle	.....	D22/108
D704,294 S *	5/2014	Jarboe	.....	D22/108
D710,477 S *	8/2014	Kauranen	.....	D22/108
D731,023 S *	6/2015	Hirt	.....	D22/108

\* cited by examiner

*Primary Examiner* — Michael A Pratt

(74) *Attorney, Agent, or Firm* — Carter Scholer Arnett Hamada Mockler PLLC

(57) **CLAIM**

The ornamental design for a firearm buttstock, as shown and described.

**DESCRIPTION**

FIG. 1 is a top perspective view of the firearm buttstock; FIG. 2 is a back view of the firearm buttstock of FIG. 1; FIG. 3 is a front view of the firearm buttstock of FIG. 1; FIG. 4 is a left side view of the firearm buttstock of FIG. 1; FIG. 5 is a right side view of the firearm buttstock of FIG. 1; FIG. 6 is a top view of the firearm buttstock of FIG. 1; and, FIG. 7 is a bottom view of the firearm buttstock of FIG. 1.

The broken lines shown in the drawings illustrate features of the article that form no part of the claim.

**1 Claim, 5 Drawing Sheets**

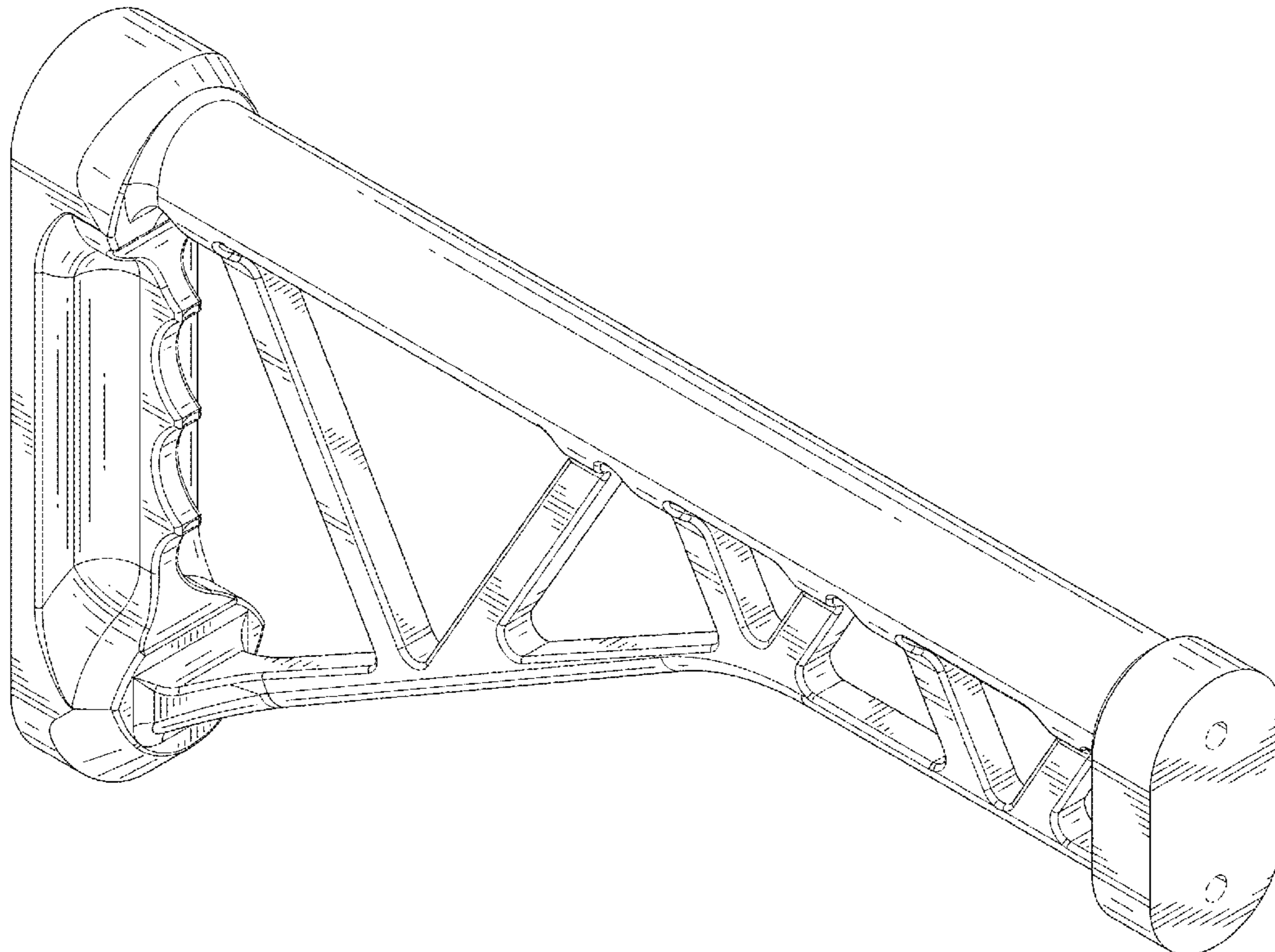

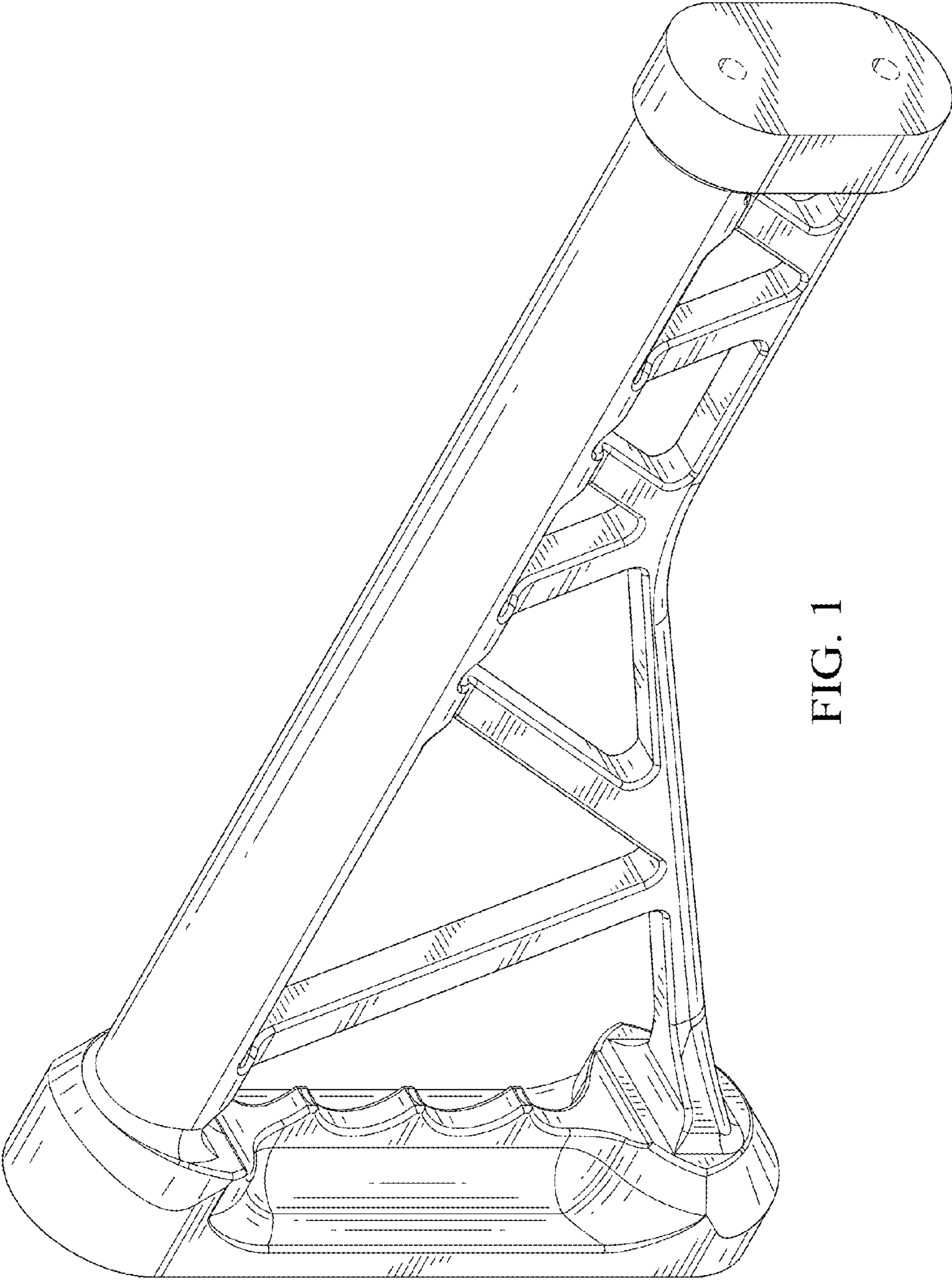

FIG. 1

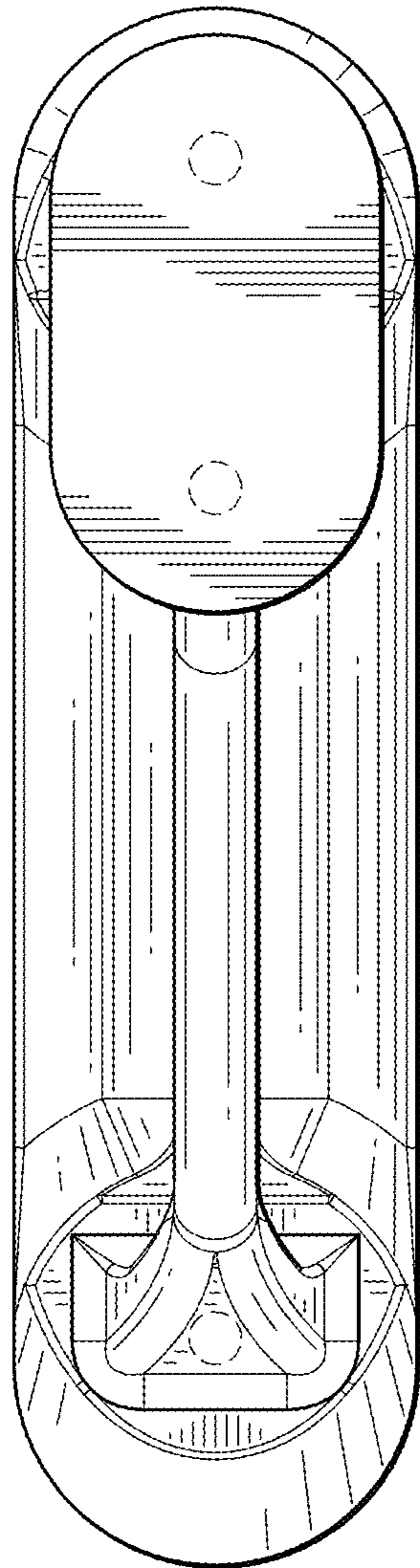

FIG. 2

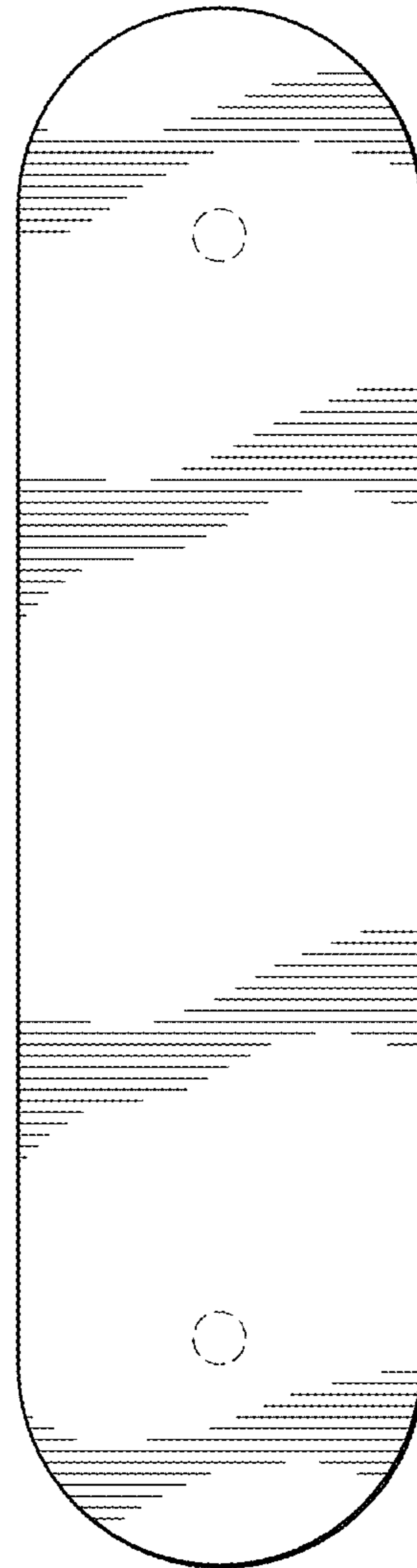

FIG. 3

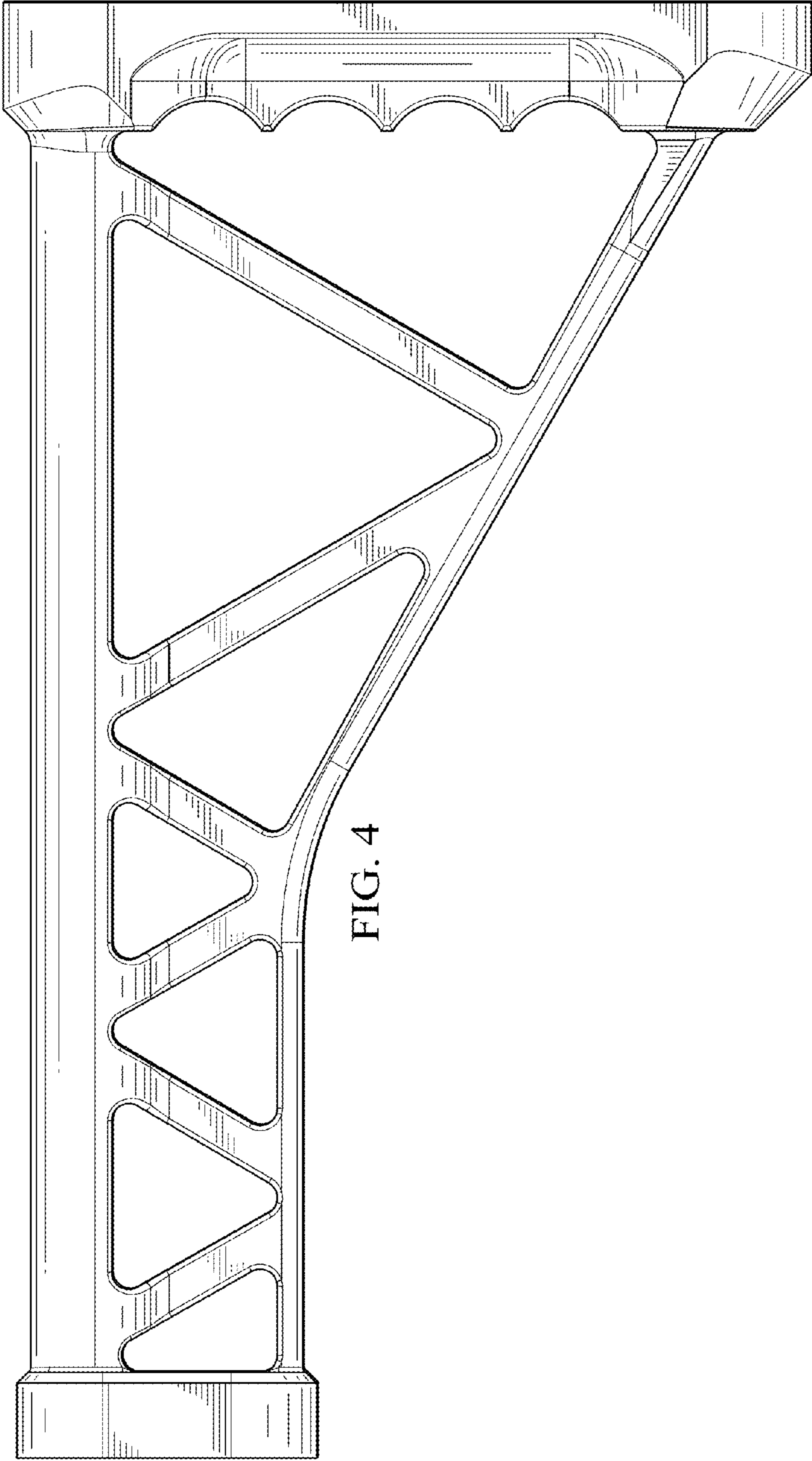

FIG. 4

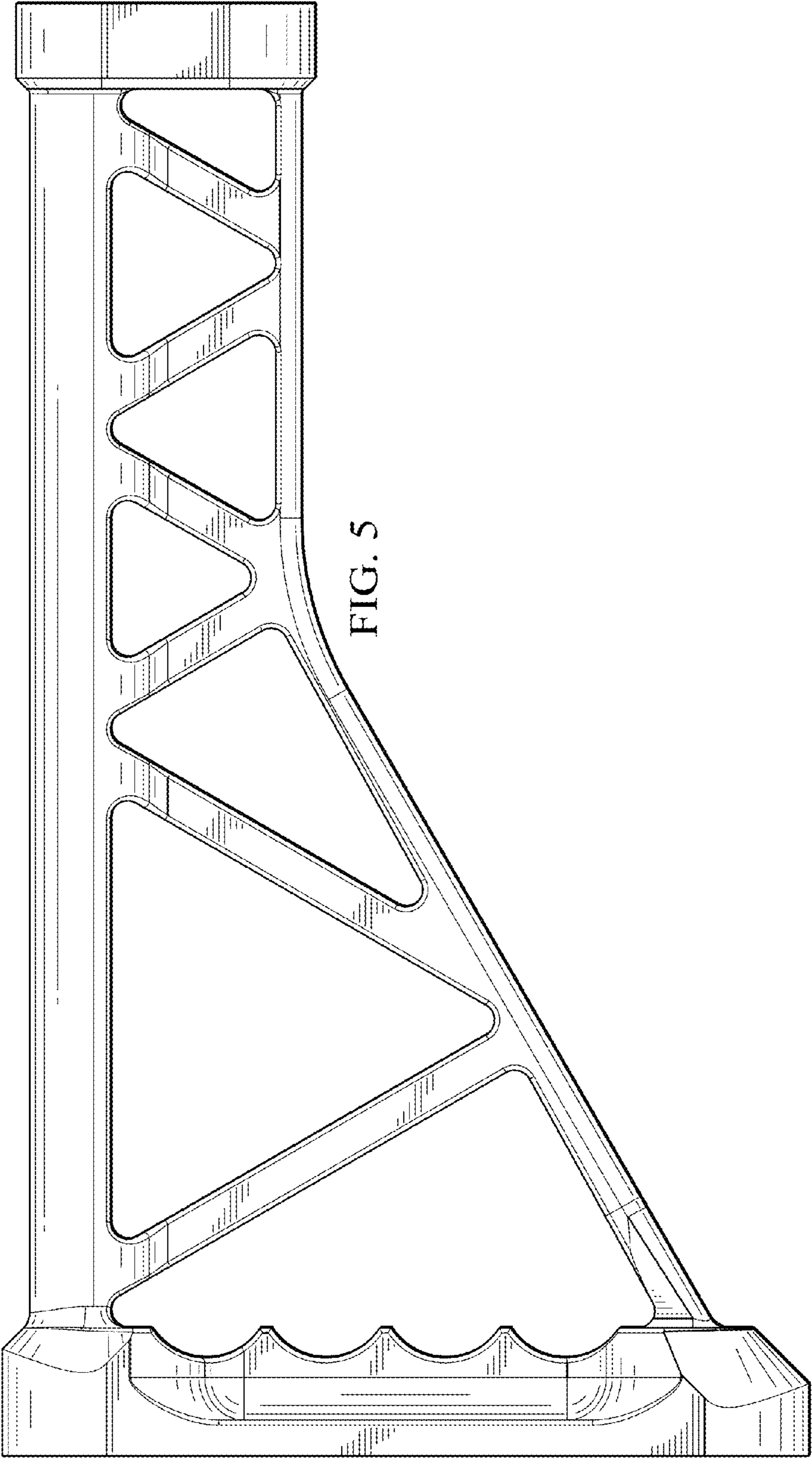

FIG. 6

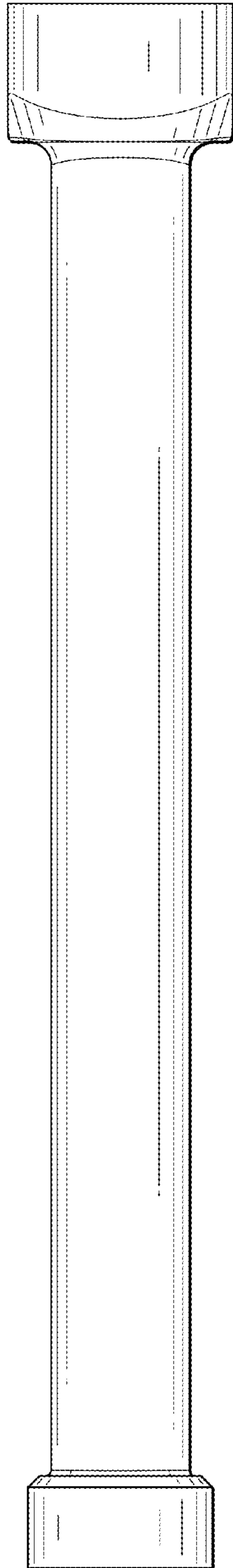

FIG. 7

