



US00D762775S

(12) **United States Design Patent**
Zhang

(10) **Patent No.:** **US D762,775 S**

(45) **Date of Patent:** **** Aug. 2, 2016**

(54) **WRITING INSTRUMENT**

(71) Applicant: **RiteLine LLC**, Dallas, TX (US)

(72) Inventor: **Enmin Zhang**, Southlake, TX (US)

(73) Assignee: **Riteline LLC**, Dallas, TX (US)

(**) Term: **14 Years**

(21) Appl. No.: **29/522,224**

(22) Filed: **Mar. 27, 2015**

(51) **LOC (10) Cl.** **19-06**

(52) **U.S. Cl.**
USPC **D19/172; D19/913; D19/914**

(58) **Field of Classification Search**
USPC D14/411; D19/115–204
CPC B43K 5/00; B43K 5/005; B43K 7/00;
B43K 7/10; B43K 7/12; B43K 8/04
See application file for complete search history.

(56) **References Cited**

U.S. PATENT DOCUMENTS

D265,212 S	6/1982	Spiegel	
D476,364 S *	6/2003	Bain	D19/172
D490,852 S *	6/2004	Finney	D19/172
D494,219 S *	8/2004	Arita	D19/174
D553,191 S *	10/2007	Qiu	D19/167
D559,318 S *	1/2008	Qiu	D19/172
D559,909 S *	1/2008	Qiu	D19/172
D570,414 S *	6/2008	Qiu	D19/168
D583,414 S	12/2008	Booker	
D592,248 S *	5/2009	Gerules	D19/174
D602,085 S *	10/2009	Matsumura	D19/172
D607,932 S *	1/2010	Zhang	D19/172
D611,537 S *	3/2010	Rolion	D19/121

D619,169 S *	7/2010	Kent	D19/172
D619,170 S *	7/2010	Kent	D19/199
D624,965 S *	10/2010	Li	D19/172
D628,641 S *	12/2010	Zhang	D19/172
D641,408 S *	7/2011	Zhang	D19/172
D641,788 S *	7/2011	Rolion	D19/171
D647,137 S *	10/2011	Uchiyama	D19/172
D651,245 S *	12/2011	Yuan	D19/172
D667,882 S *	9/2012	Uchiyama	D19/172
D672,812 S *	12/2012	Zhang	D19/172
D672,813 S *	12/2012	Zhang	D19/172
D692,483 S *	10/2013	Laemle	D19/172
D692,484 S *	10/2013	Laemle	D19/172
D700,238 S	2/2014	Slemp	
D706,348 S	6/2014	Inoue et al.	
D726,825 S *	4/2015	Casciotti	D19/171

* cited by examiner

Primary Examiner — Elizabeth Albert

(74) *Attorney, Agent, or Firm* — Wei Wei Jeang; Grable Martin Fulton PLLC

(57) **CLAIM**

The ornamental design for a writing instrument, as shown and described.

DESCRIPTION

FIG. 1 is a front elevational view of a writing instrument showing our new design;
FIG. 2 is a rear elevational view thereof;
FIG. 3 is a right side elevational view thereof;
FIG. 4 is a left side elevational view thereof
FIG. 5 is a left, front bottom perspective view thereof;
FIG. 6 is a right, front, bottom perspective view thereof; and,
FIG. 7 is a bottom plan view thereof.

1 Claim, 3 Drawing Sheets

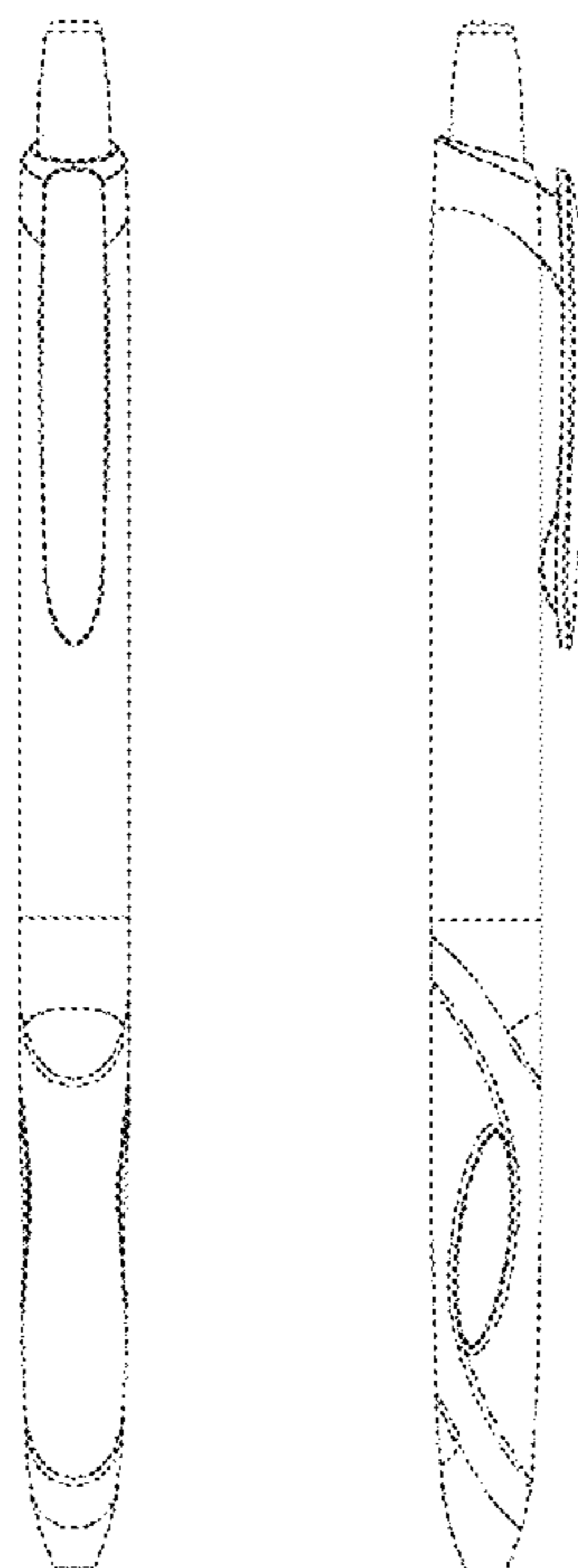

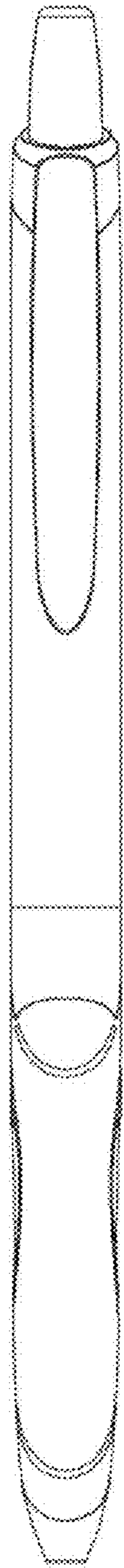

FIG .1

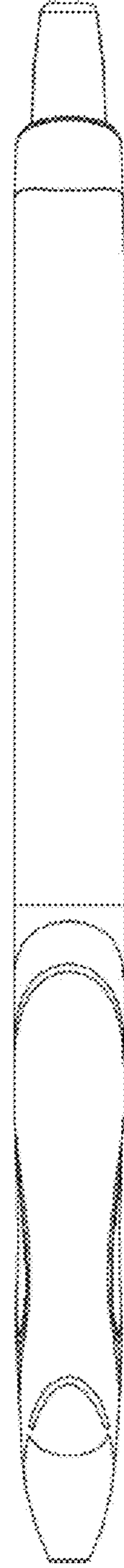

FIG .2

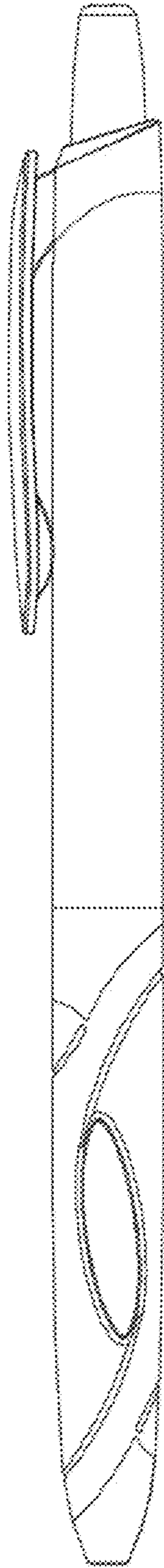

FIG .3

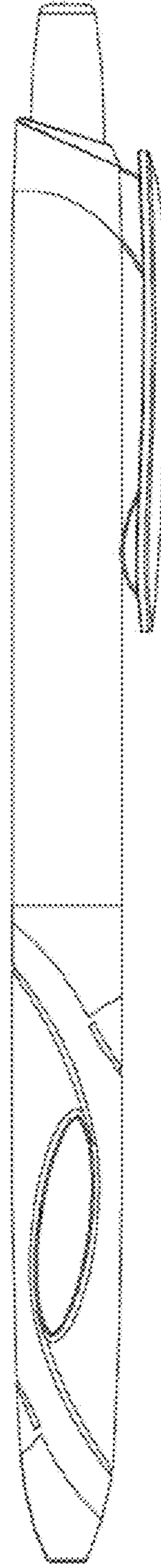

FIG .4

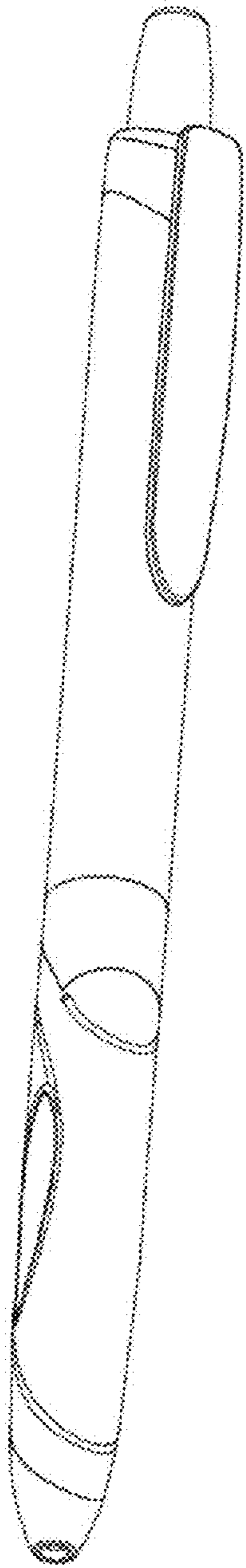

FIG .5

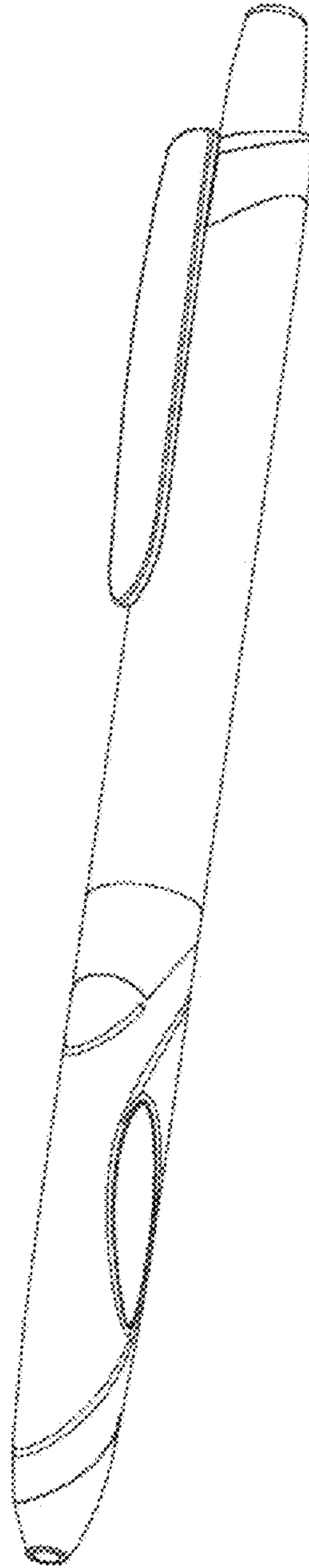

FIG .6

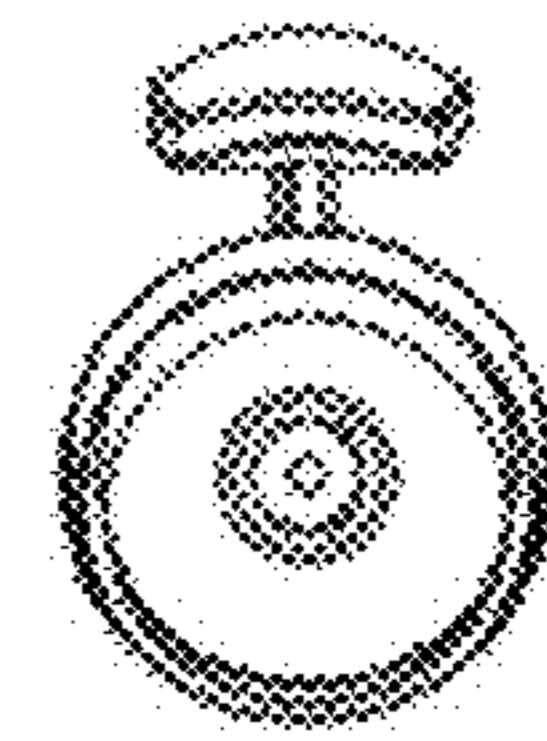

FIG .7