



US00D762716S

(12) **United States Design Patent**
Yang et al.

(10) **Patent No.:** **US D762,716 S**
(45) **Date of Patent:** **** Aug. 2, 2016**

(54) **DISPLAY SCREEN OR PORTION THEREOF WITH ANIMATED GRAPHICAL USER INTERFACE**

D724,621	S	*	3/2015	Rydenhag	D14/489
D740,300	S	*	10/2015	Lee	D14/485
D743,992	S	*	11/2015	Lee	D14/487
D751,606	S	*	3/2016	Yu	D14/494
2013/0162571	A1	*	6/2013	Tamegai	G06F 3/0412 345/173

(71) Applicant: **Huawei Device Co., LTD**, Shenzhen (CN)

(72) Inventors: **Huan Yang**, Beijing (CN); **Min Liu**, Beijing (CN)

(73) Assignee: **Huawei Device Co., Ltd.**, Shenzhen (CN)

(**) Term: **14 Years**

(21) Appl. No.: **29/482,794**

(22) Filed: **Feb. 21, 2014**

(51) **LOC (10) CL.** **14-04**

(52) **U.S. CL.**
USPC **D14/489**

(58) **Field of Classification Search**
USPC D14/485-495
CPC G06T 13/80; G06T 15/02; H04N 1/00424;
G06F 3/04817; G06F 3/0481
See application file for complete search history.

(56) **References Cited**

U.S. PATENT DOCUMENTS

7,489,297	B2	*	2/2009	Hohmann	G06F 3/043 345/156
D599,814	S	*	9/2009	Ogura	D14/489
D644,661	S	*	9/2011	Gardner	D14/495
D650,789	S	*	12/2011	Arnold	D14/488
D650,790	S	*	12/2011	Jeans	D14/488
D652,841	S	*	1/2012	Arnold	D14/488
D656,954	S	*	4/2012	Arnold	D14/489
D669,497	S	*	10/2012	Lee	D14/489
D669,499	S	*	10/2012	Gardner	D14/495

OTHER PUBLICATIONS

Babiak, Olly. 'circle'. dribbble.com [online]. Nov. 27, 2014 [retrieved Apr. 12, 2016]. Retrieved from the Internet: <URL: https://dribbble.com/shots/1825518-circle>.*

(Continued)

Primary Examiner — Eric Goodman

Assistant Examiner — Megan M Majcher Hartnett

(74) *Attorney, Agent, or Firm* — Slater Matsil, LLP

(57) **CLAIM**

The ornamental design for a display screen or portion thereof with animated graphical user interface, as shown and described.

DESCRIPTION

FIG. 1 is a front view of a first image of a display screen or portion thereof with animated graphical user interface showing our new design;

FIG. 2 is a front view of a second image thereof;

FIG. 3 is a front view of a third image thereof; and

FIG. 4 is a front view of a fourth image thereof.

FIG. 5 is a front view of a fifth image thereof; and,

FIG. 6 is a front view of a sixth image thereof.

The appearance of the image transitions sequentially between the images shown in FIGS. 1-6. The process or period in which an image transitions to another forms no part of the claimed design.

The broken lines showing of the display screen, images and text form no part of the claimed design.

1 Claim, 6 Drawing Sheets

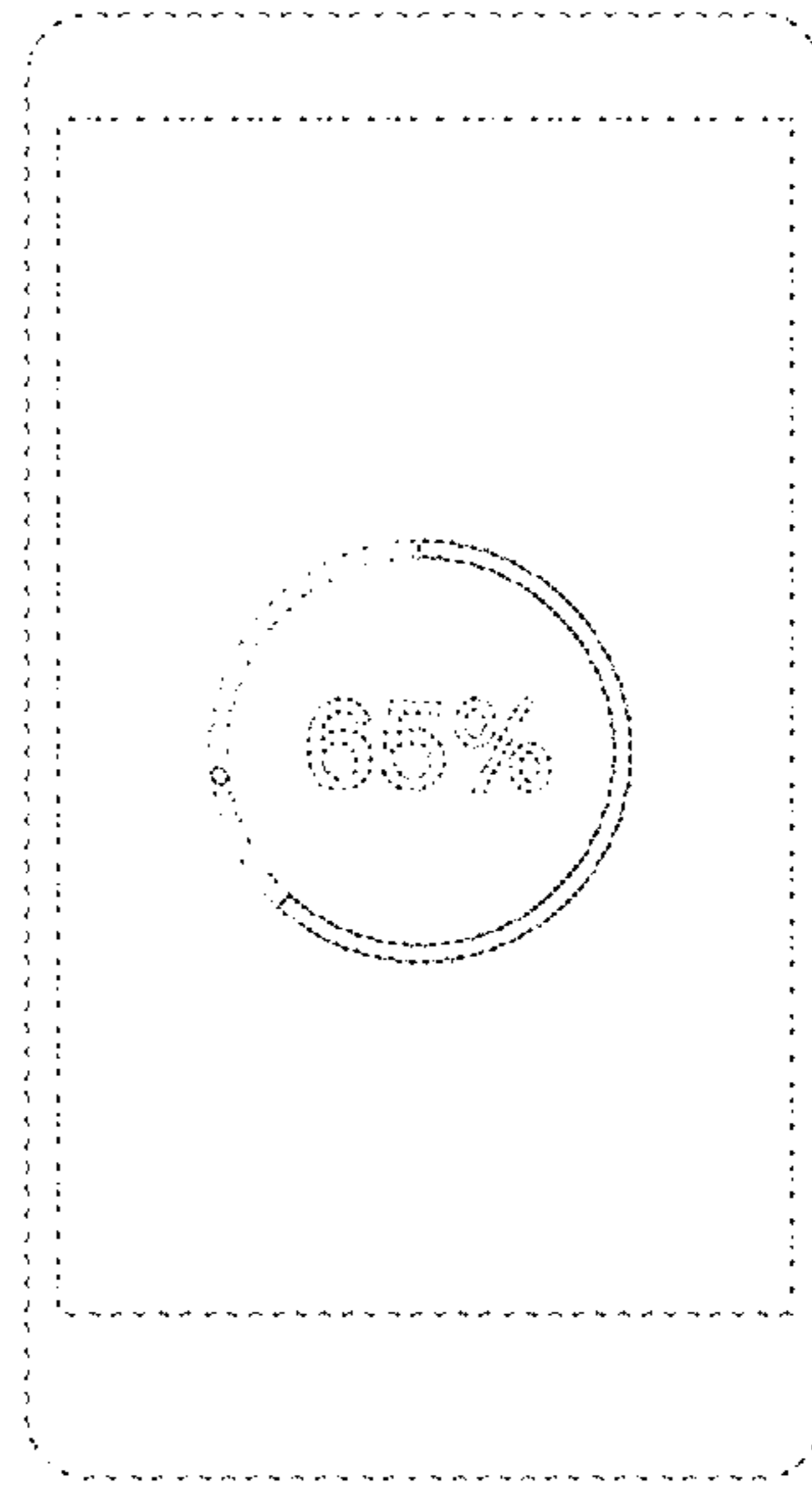
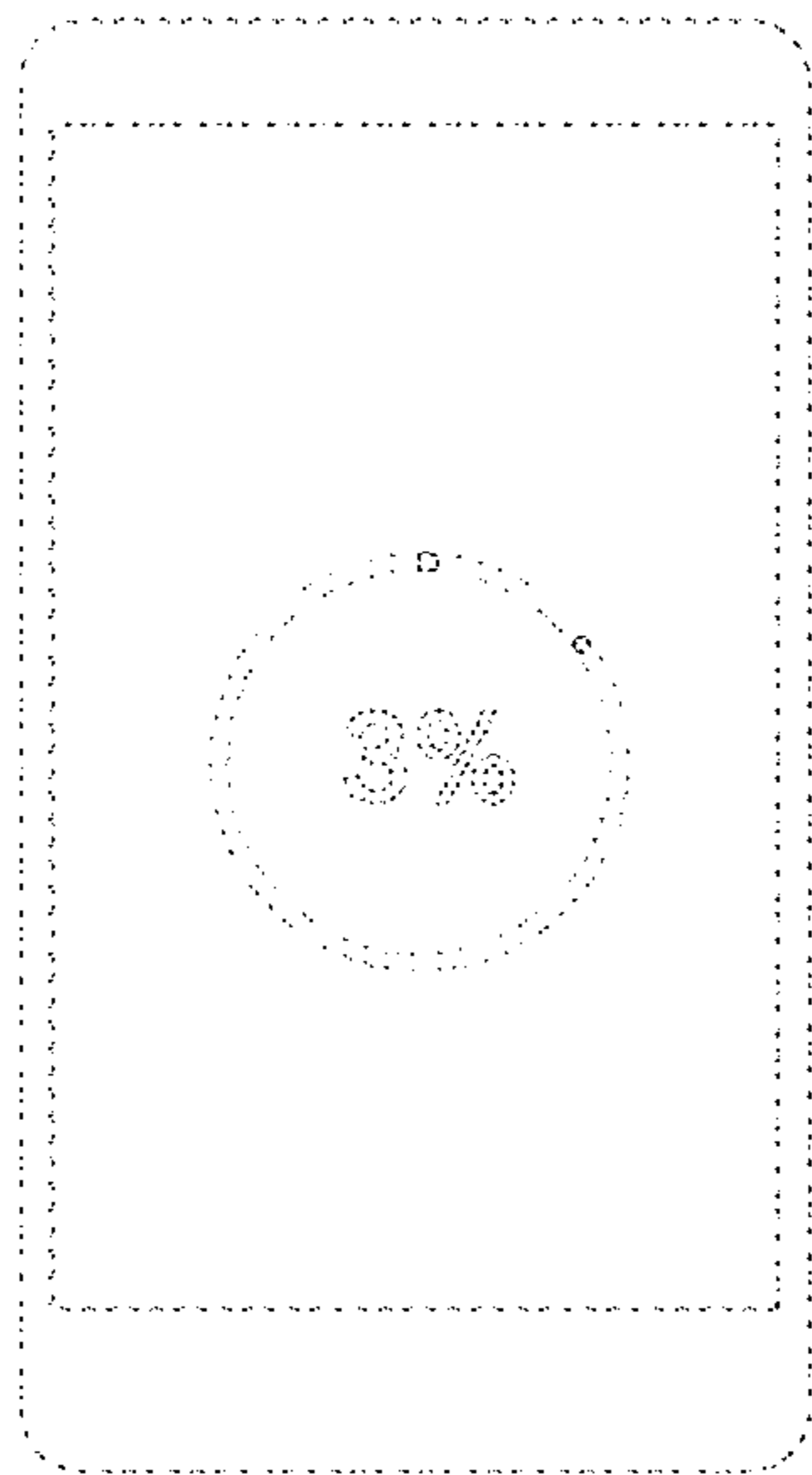

(56)

References Cited

OTHER PUBLICATIONS

'Video Tutorial: Circle Loading Animation'. youtube.com [online]. Feb. 20, 2014 [retrieved Apr. 12, 2016]. Retrieved from the Internet: <URL: <https://www.youtube.com/watch?v=hqKOec1z5ko>>.*
Khoury, Adam. 'Circular Dynamic Preloader Tutorial—Flash CS4 CS5.5 ActionScript 3.0 Website Content Loader'. youtube.com [online]. Dec. 13, 2009 [retrieved Apr. 12, 2016]. Retrieved from the

Internet: <URL: <https://www.youtube.com/watch?v=y-Nimeht-Vo>>.*

Cacho, Christopher P. 'Loading Color'. dribbble.com [online]. Mar. 25, 2014 [retrieved Apr. 11, 2016]. Retrieved from the Internet: <URL: <https://dribbble.com/shots/1478895-Loading-Color>>.*

Frolov, Oleg. 'Spinner III'. dribbble.com [online]. Sep. 20, 2015 [retrieved Apr. 12, 2016]. Retrieved from the Internet: <URL: <https://dribbble.com/shots/2253433-Spinner-III>>.*

* cited by examiner

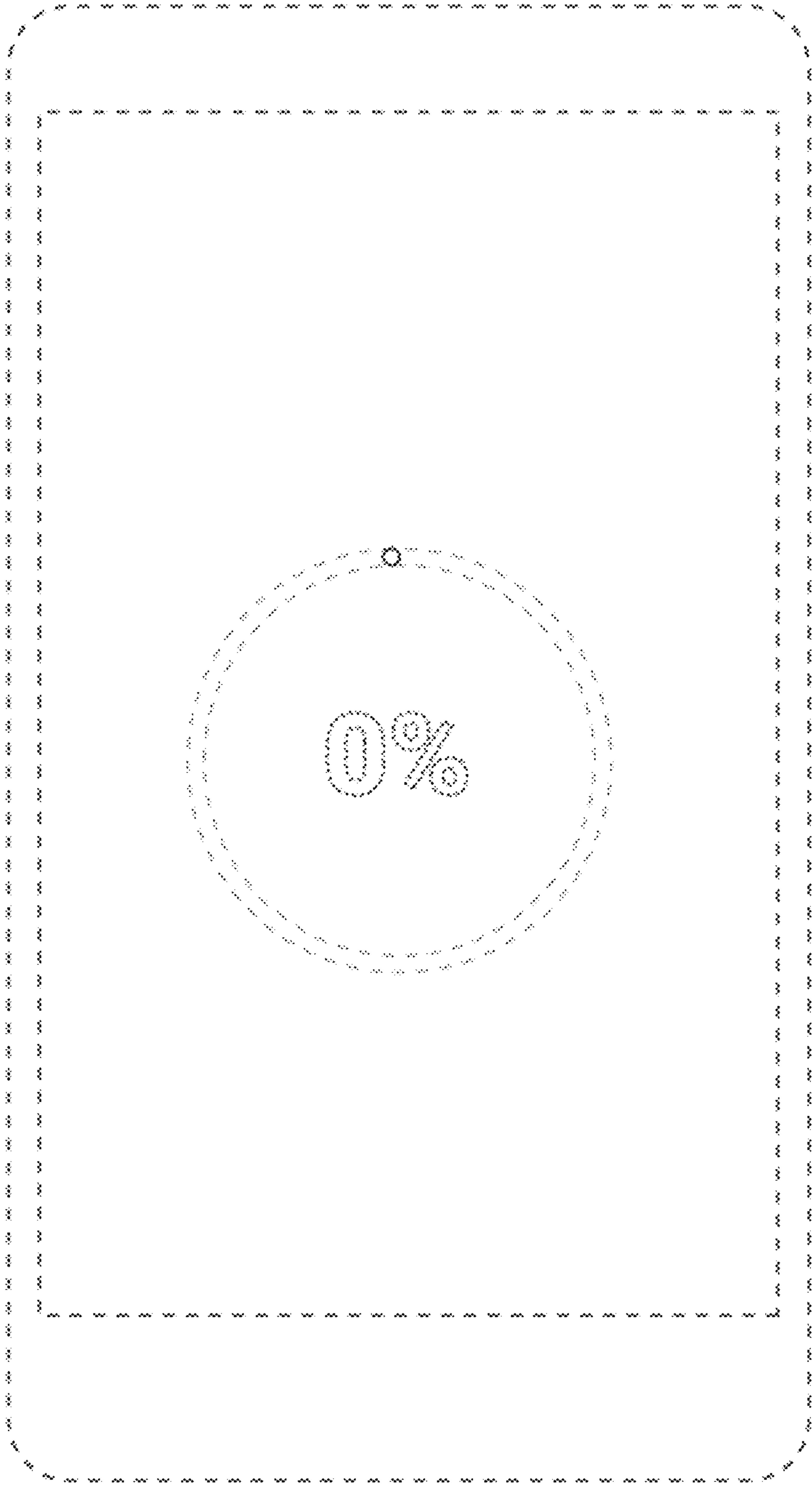

Figure 1

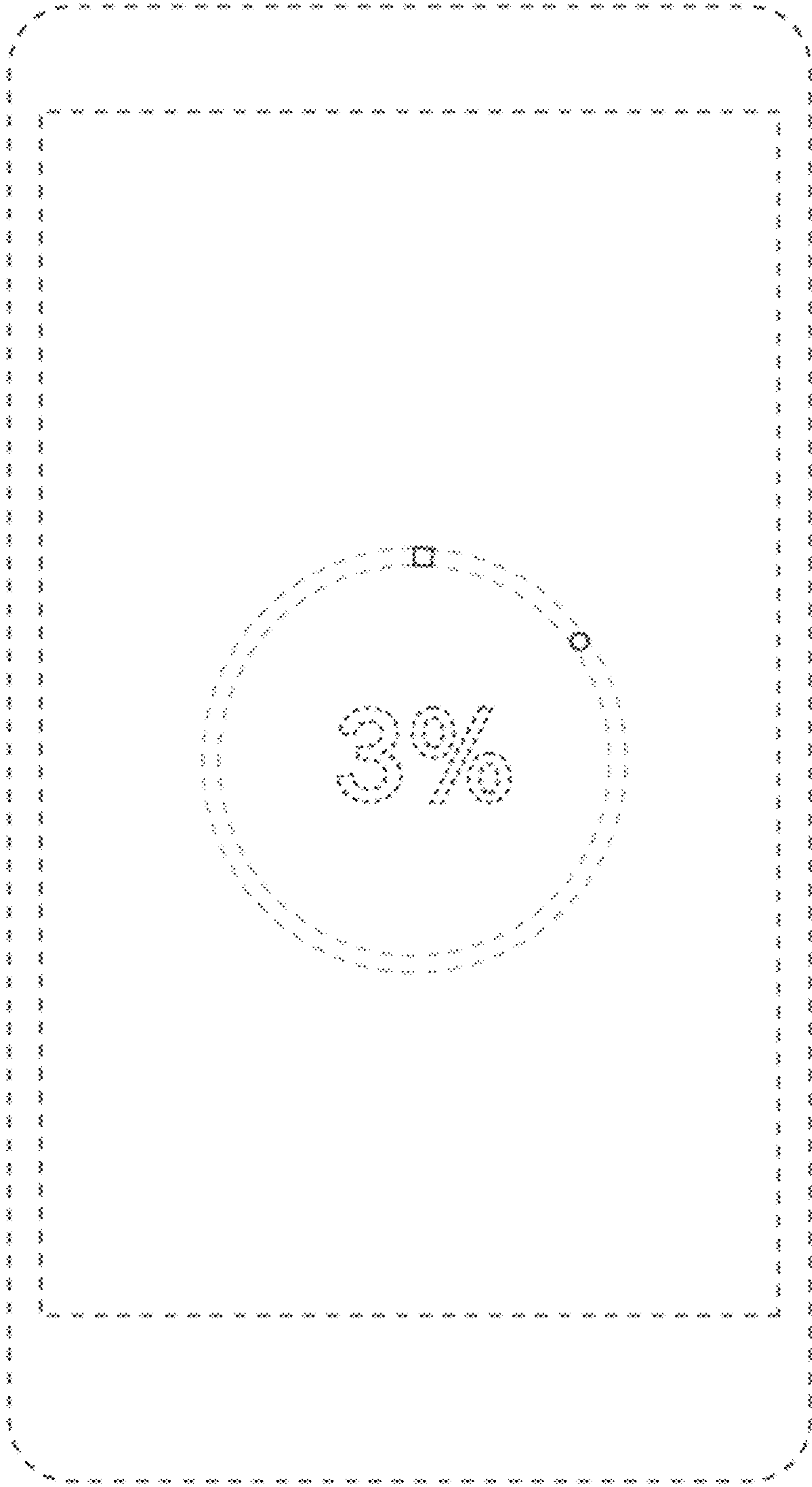

Figure 2

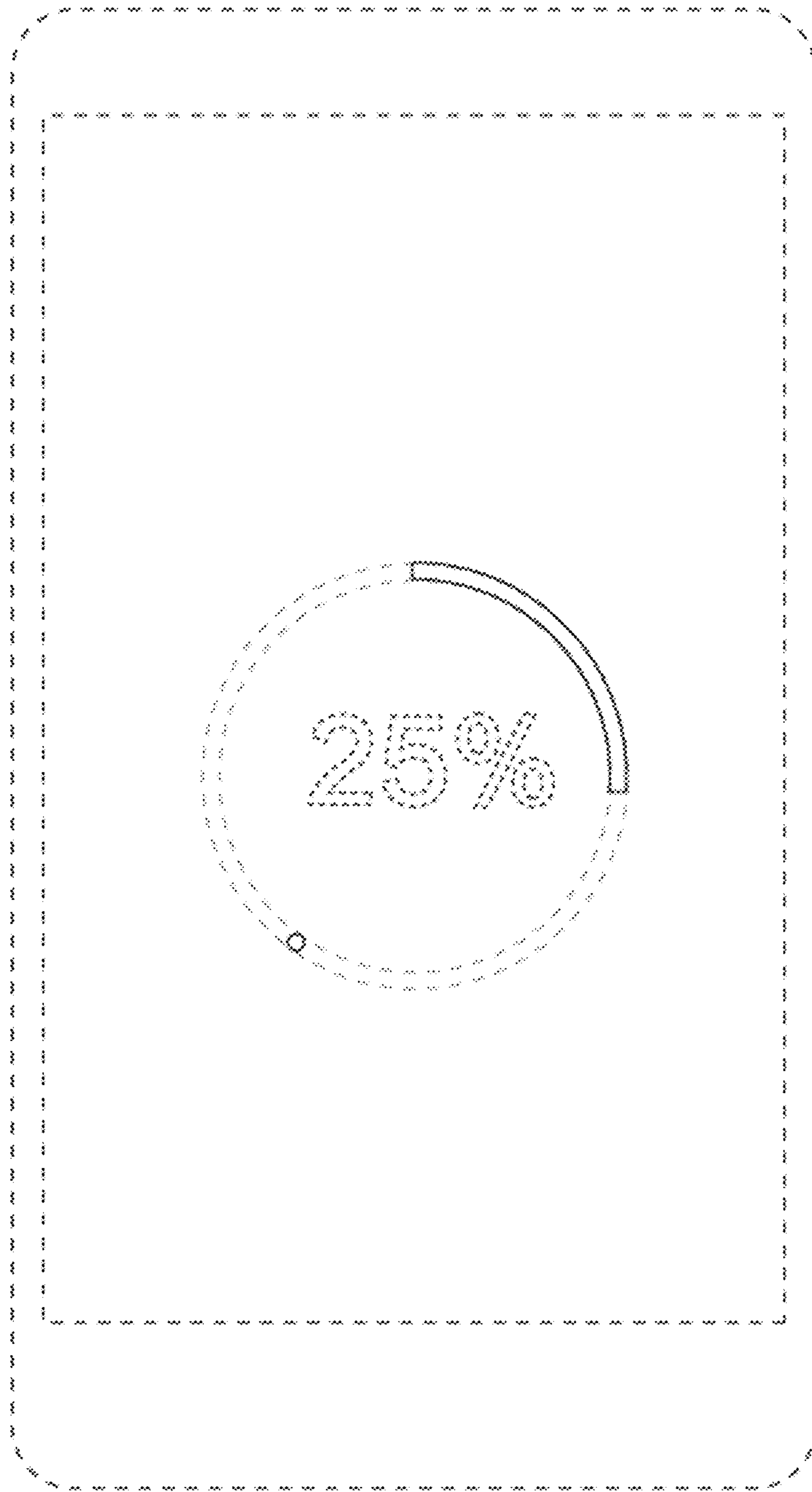

Figure 3

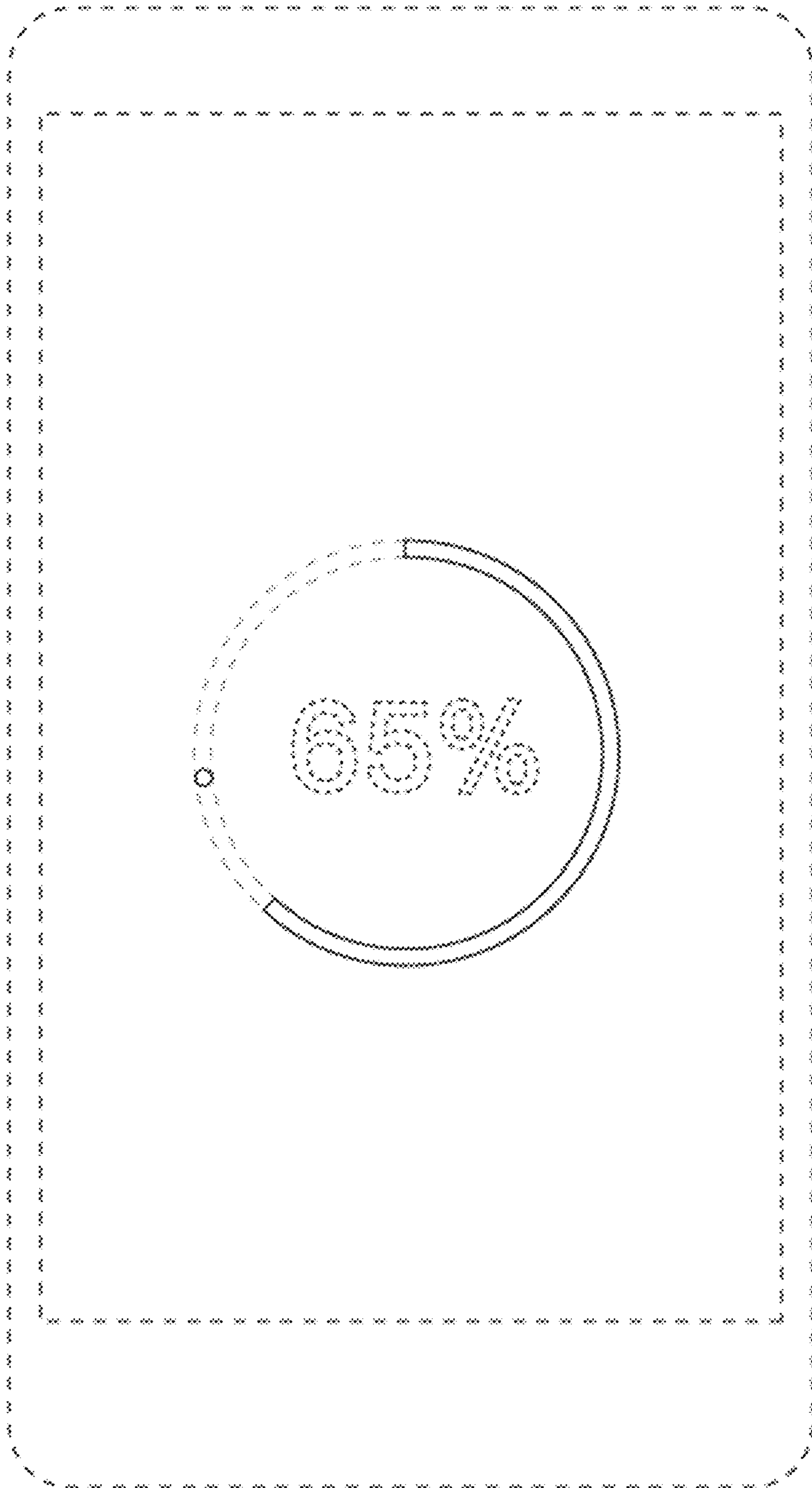

Figure 4

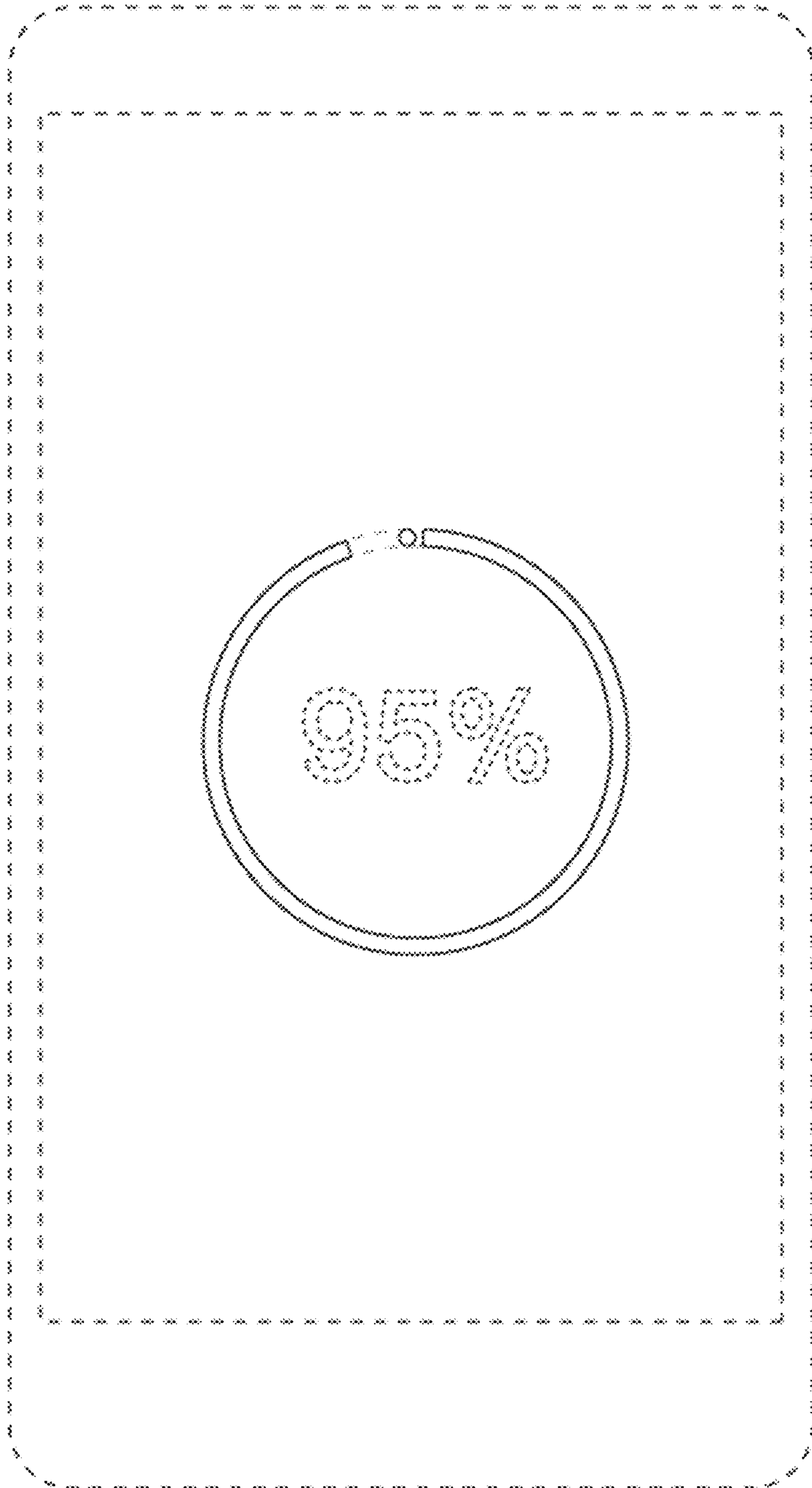

Figure 5

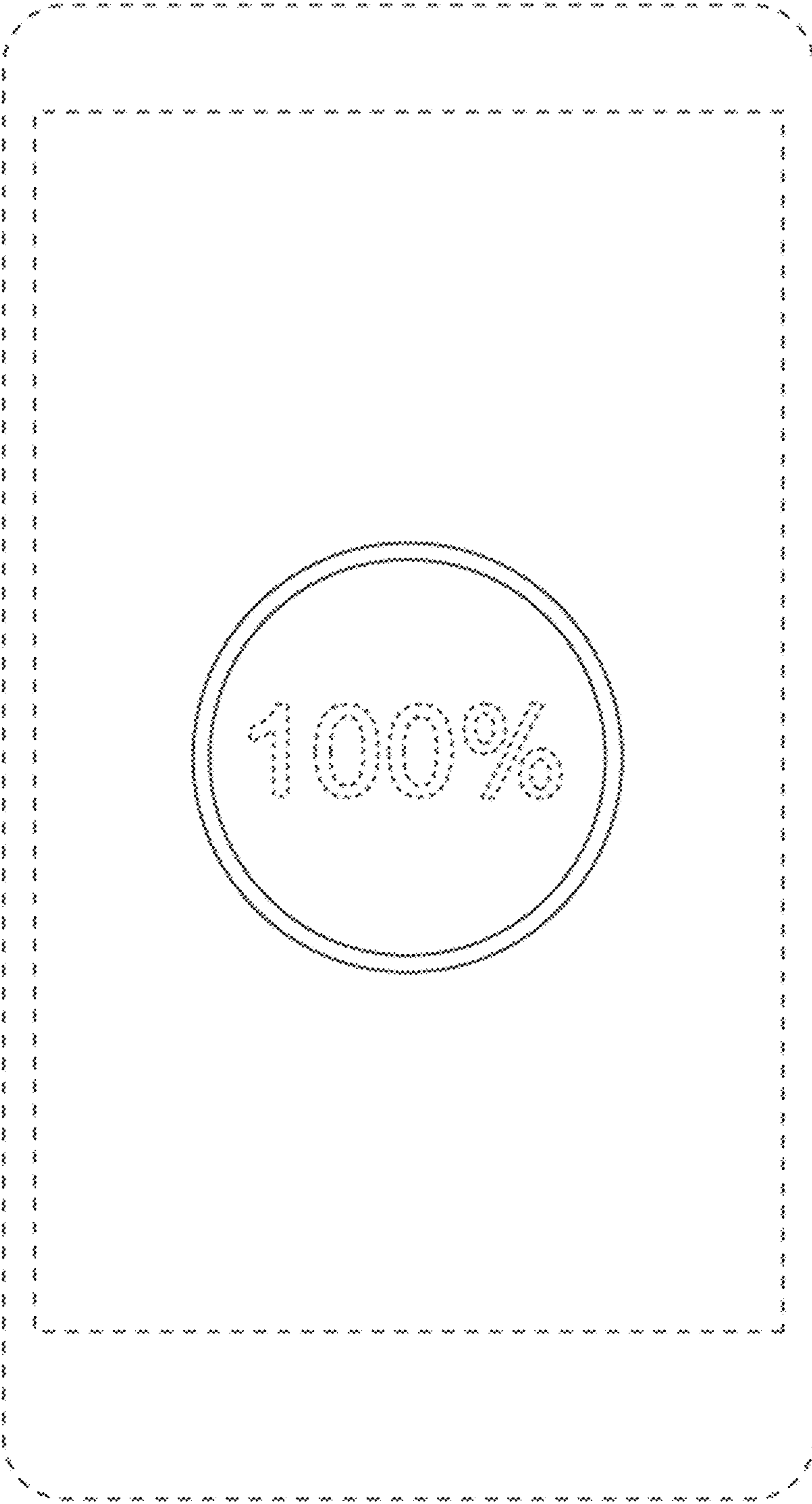

Figure 6