

US00D762546S

(12) **United States Design Patent**
Giolito

(10) **Patent No.:** **US D762,546 S**

(45) **Date of Patent:** **** Aug. 2, 2016**

(54) **WHEEL**

(71) Applicant: **FCA Italy S.p.A.**, Turin (IT)

(72) Inventor: **Roberto Giolito**, Turin (IT)

(73) Assignee: **FCA ITALY S.p.A.**, Turin (IT)

(**) Term: **15 Years**

(21) Appl. No.: **29/544,875**

(22) Filed: **Nov. 6, 2015**

(30) **Foreign Application Priority Data**

May 21, 2015 (EM) 002704932

(51) **LOC (10) Cl.** **12-16**

(52) **U.S. Cl.**

USPC **D12/209**

(58) **Field of Classification Search**

USPC D12/204–213

CPC B60B 7/00; B60B 7/02; B60B 7/04;

B60B 7/01; B60B 7/06; B60B 3/02; B60B

3/04; B60B 3/06; B60B 3/10; B60B 1/00;

B60B 1/08; B60B 1/10; B60B 1/12

See application file for complete search history.

(56) **References Cited**

U.S. PATENT DOCUMENTS

D351,582 S *	10/1994	Echazabel	D12/209
D385,843 S *	11/1997	Cullen	D12/209
D410,613 S *	6/1999	Brown	D12/209
D504,096 S *	4/2005	Nakagawa	D12/209
D573,932 S *	7/2008	Laengerer	D12/209
D616,799 S *	6/2010	Zhao	D12/209
D723,445 S *	3/2015	Hodges	D12/209
D734,235 S *	7/2015	Juergens	D12/209
D740,197 S *	10/2015	Valencia Pollex	D12/209

* cited by examiner

Primary Examiner — Stacia Cadmus

(74) *Attorney, Agent, or Firm* — Cowan, Liebowitz & Latman, P.C.

(57) **CLAIM**

The ornamental design for a wheel, as shown and described.

DESCRIPTION

FIG. 1 is a perspective view of the wheel showing my design thereof;

FIG. 2 is a front view thereof;

FIG. 3 is a right side view thereof;

FIG. 4 is a left side view thereof;

FIG. 5 is a top view thereof; and,

FIG. 6 is a bottom view thereof.

1 Claim, 6 Drawing Sheets

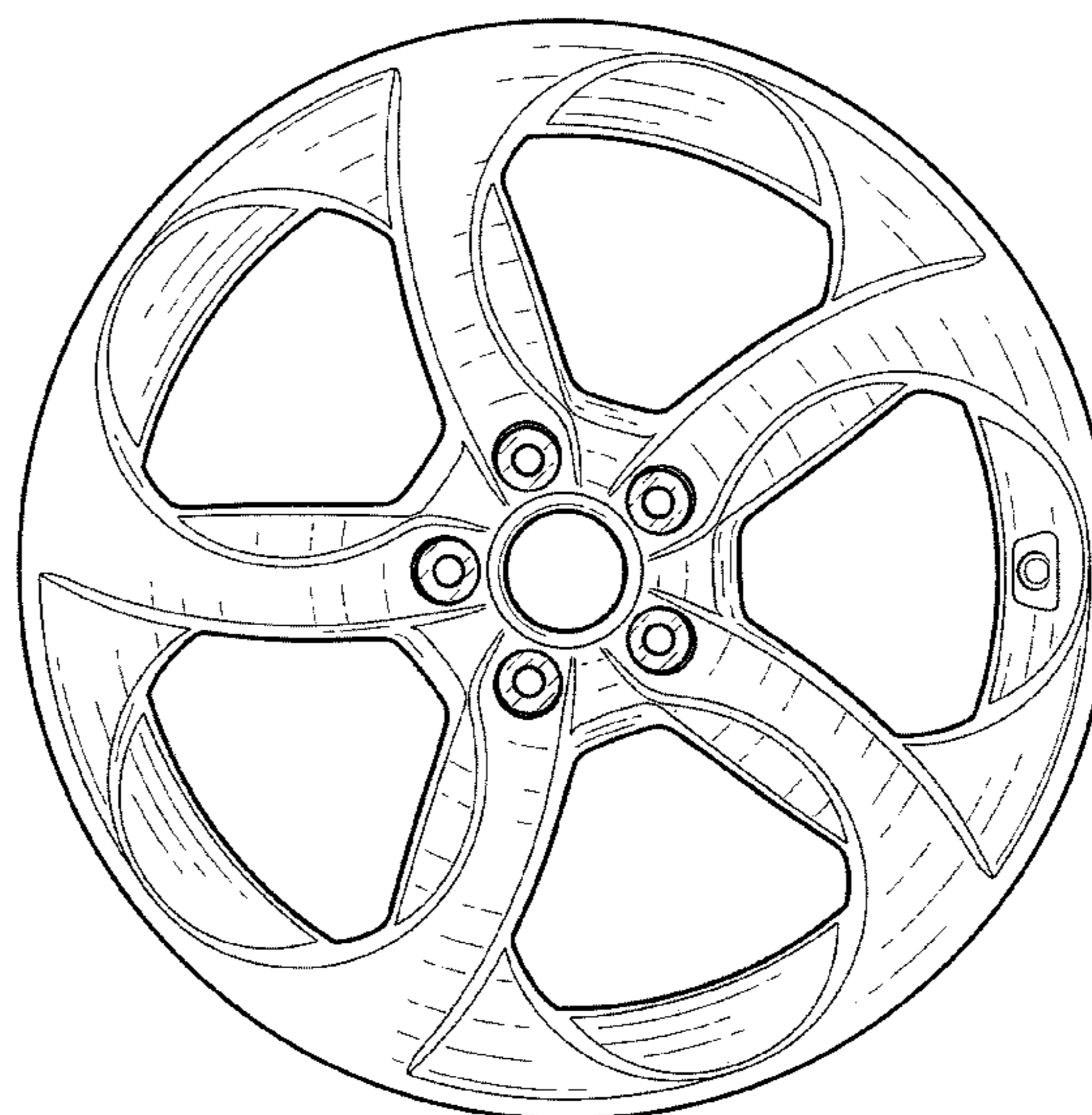
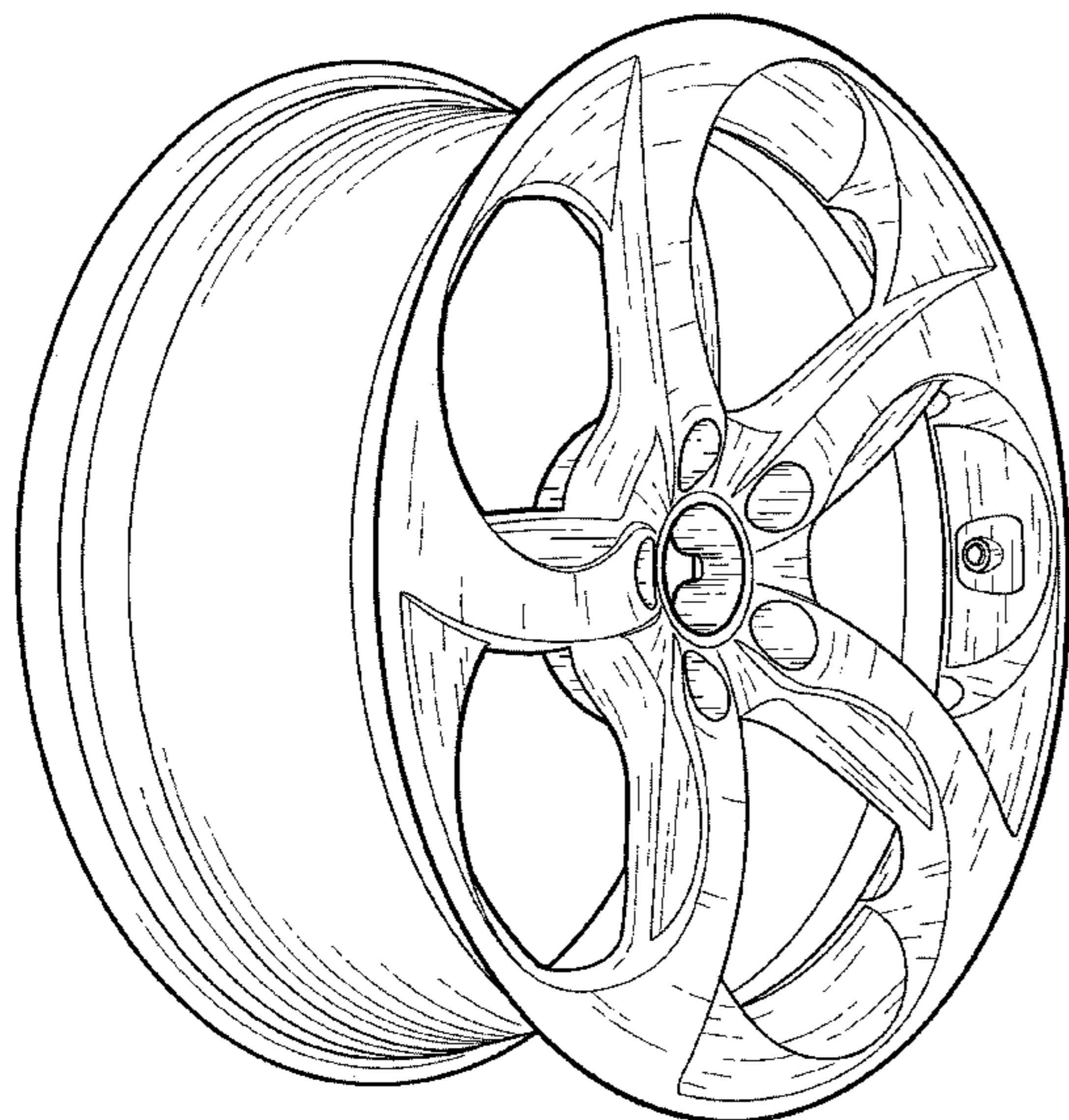

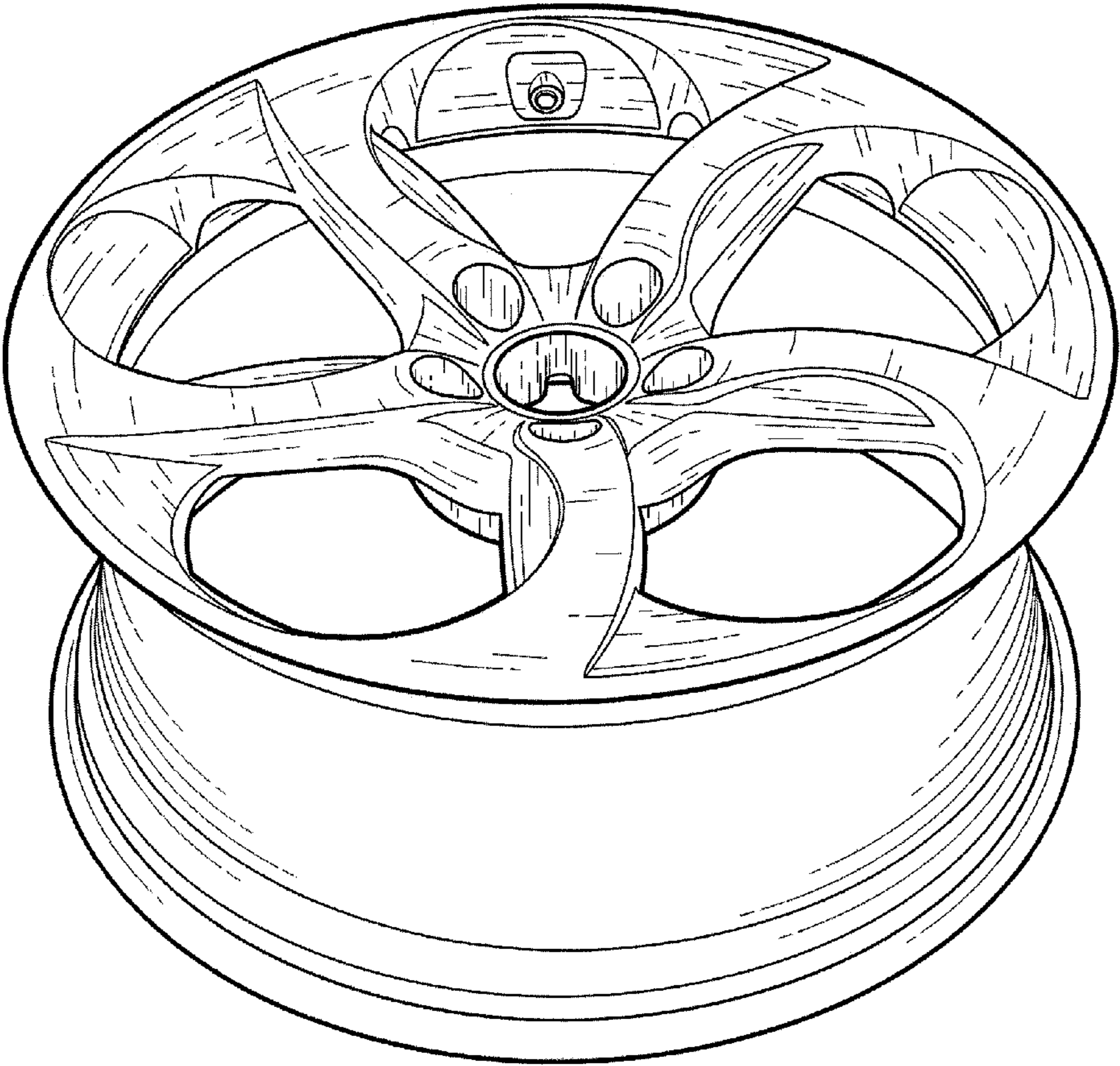

Fig. 1

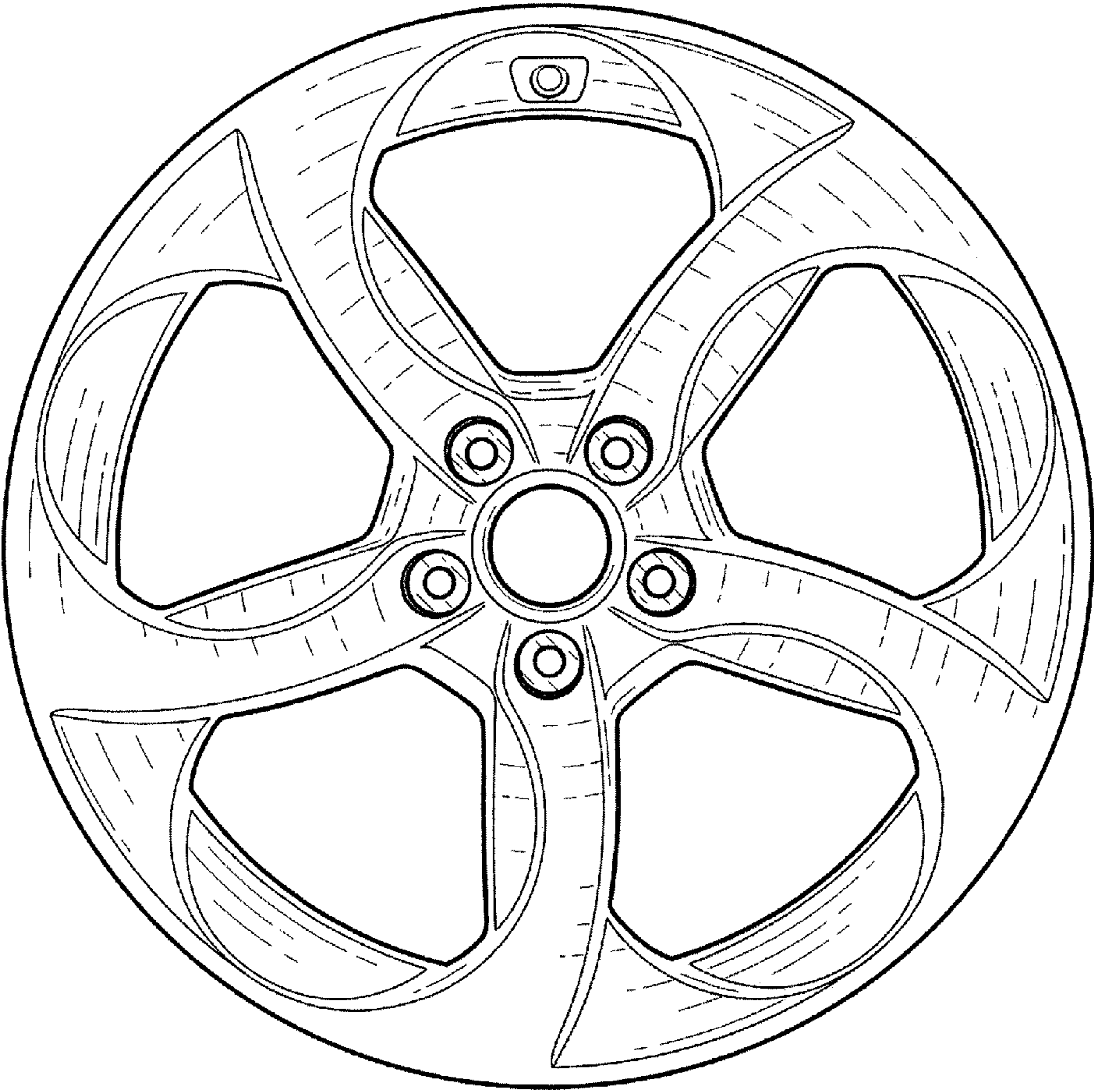

Fig. 2

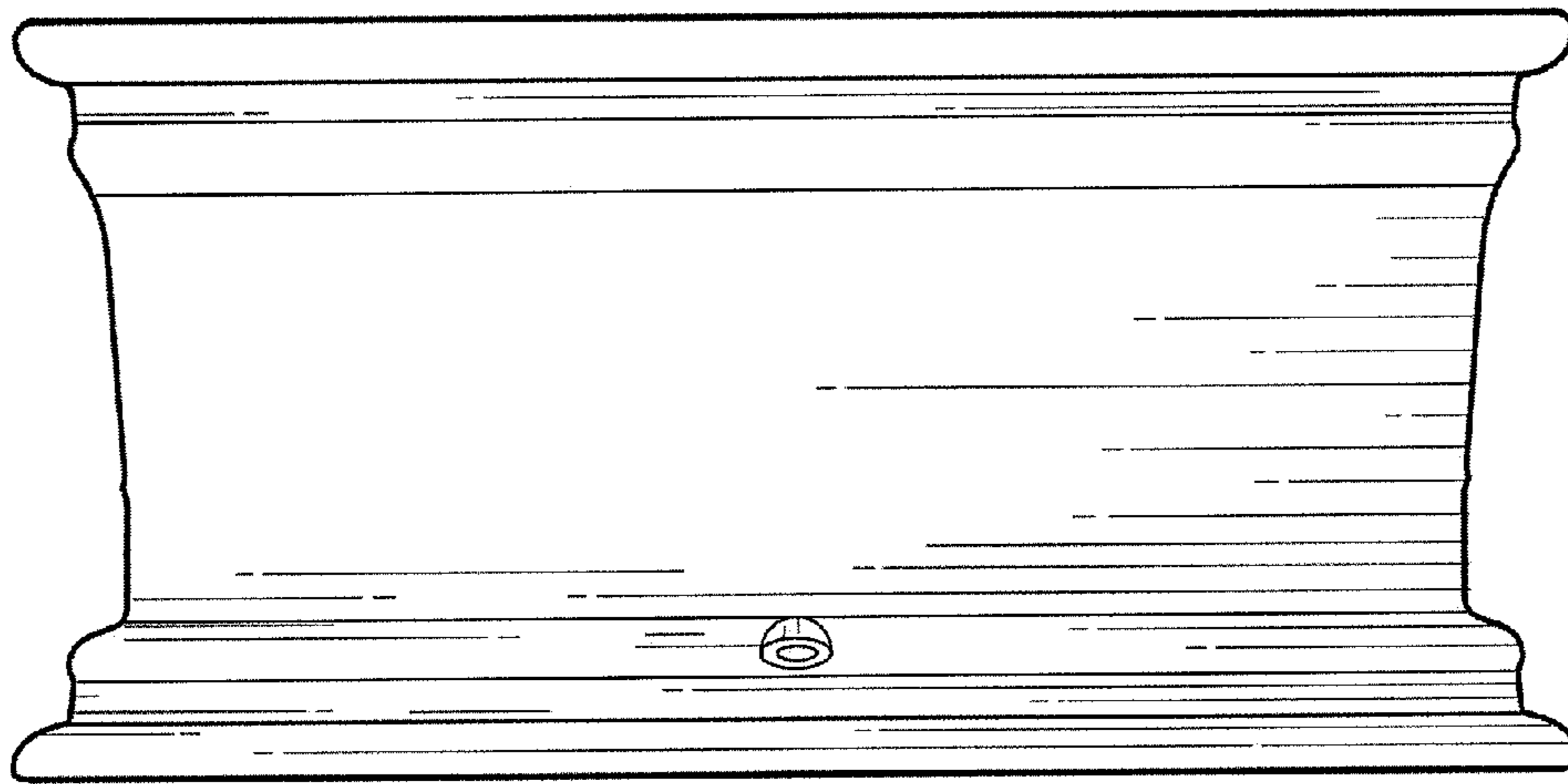

Fig. 3

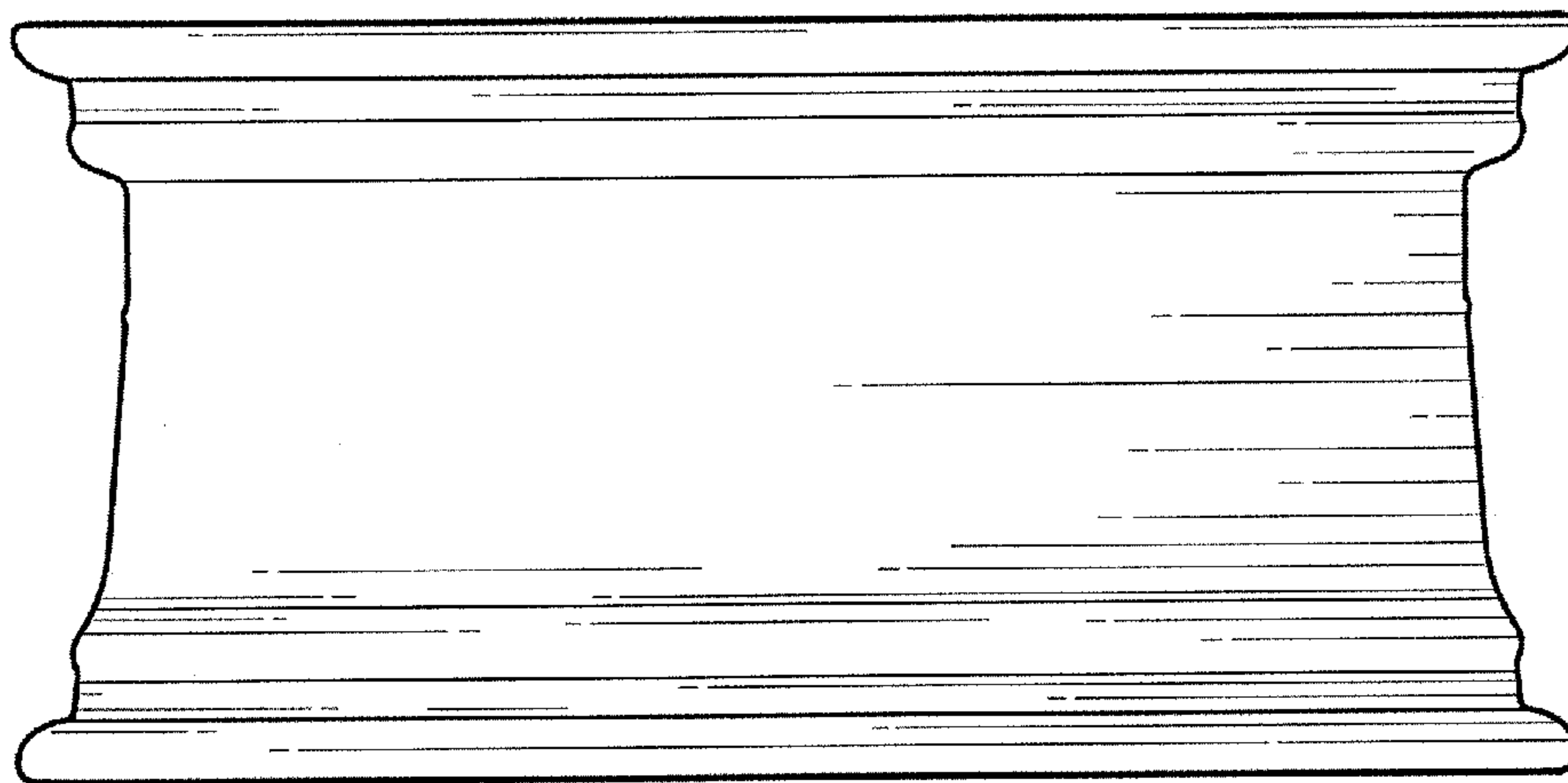

Fig. 4

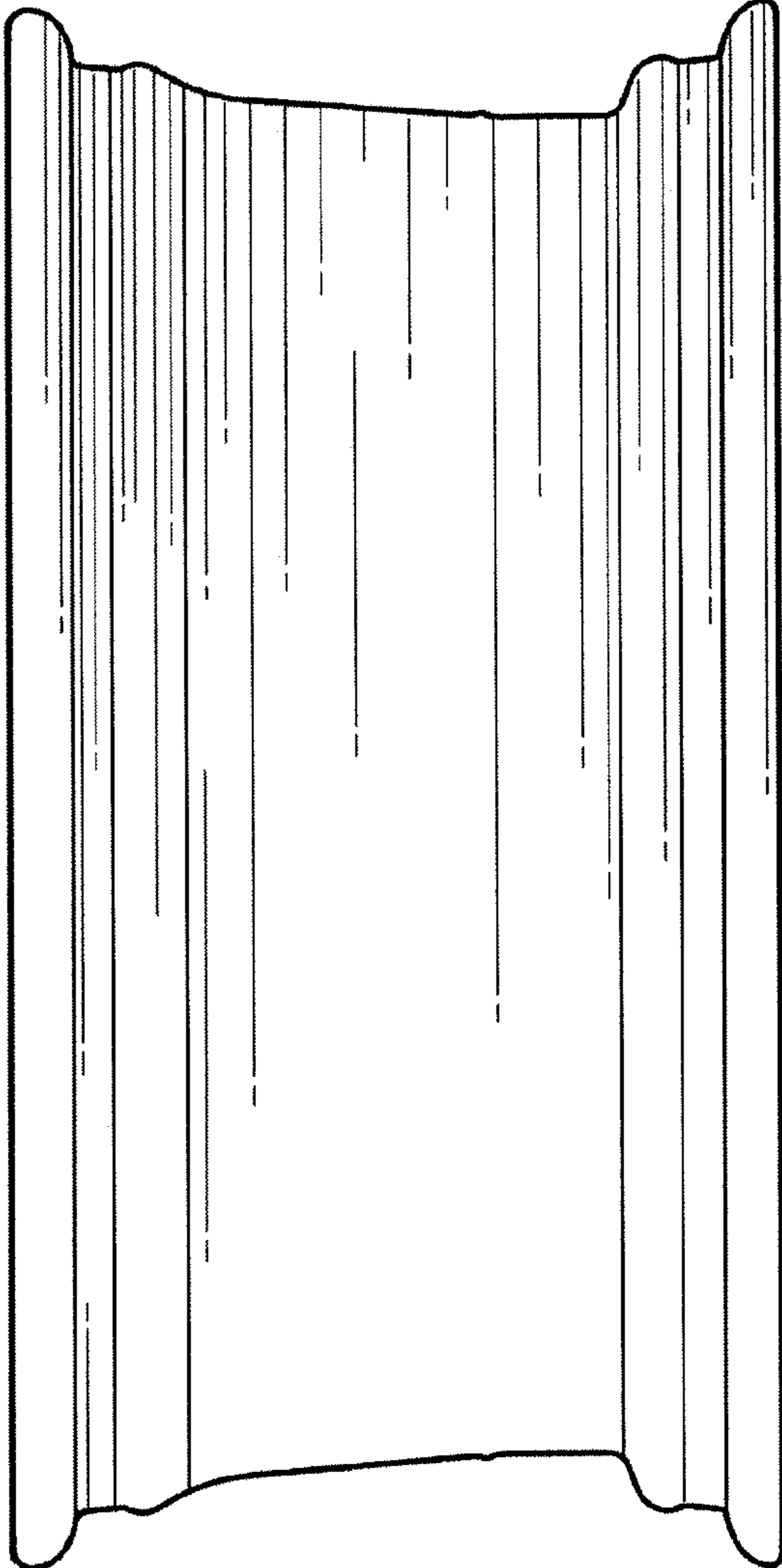

Fig. 5

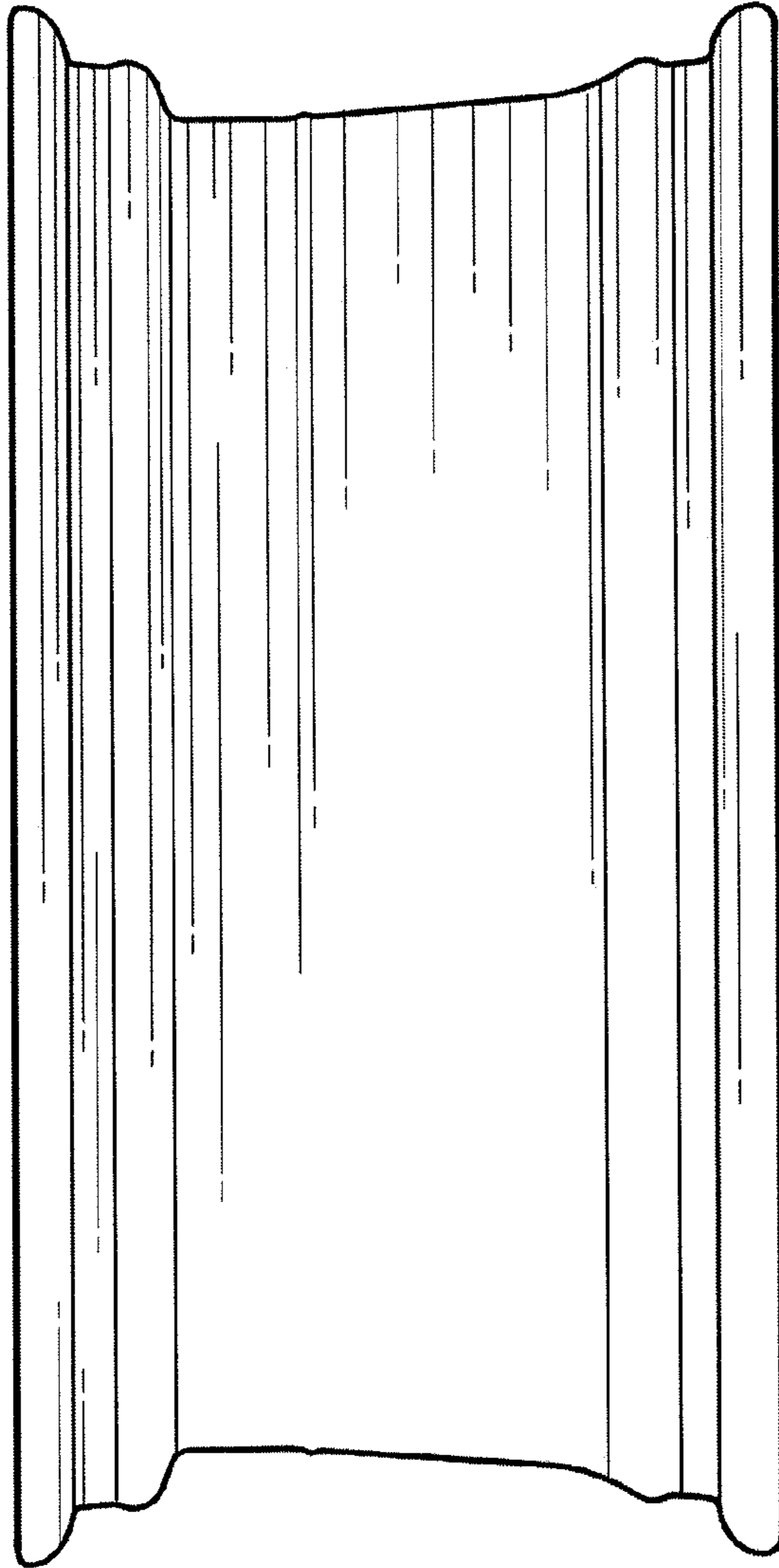

Fig. 6