



US00D762517S

(12) **United States Design Patent**
Hashimoto et al.

(10) **Patent No.:** **US D762,517 S**
(45) **Date of Patent:** **** Aug. 2, 2016**

(54) **FRONT STRUCTURE OF UTILITY VEHICLE**

(71) Applicant: **Kawasaki Jukogyo Kabushiki Kaisha,**
Hyogo (JP)

(72) Inventors: **Naoki Hashimoto,** Kakogawa (JP);
Minoru Kobayashi, Kakogawa (JP);
Norikazu Matsumura, Akashi (JP)

(73) Assignee: **Kawasaki Jukogyo Kabushiki Kaisha,**
Hyogo (JP)

(**) Term: **15 Years**

(21) Appl. No.: **29/528,684**

(22) Filed: **May 29, 2015**

(51) **LOC (10) Cl.** **12-13**

(52) **U.S. Cl.**
USPC **D12/14**

(58) **Field of Classification Search**
USPC D12/1, 2, 13, 12, 15, 14, 16, 86, 87, 3,
D12/4, 5, 85, 107, 110, 173; D21/14, 424,
D21/433, 803; D15/30; 296/1.01, 24.33,
296/181.1, 181.2, 181.4, 187.01, 187.09,
296/187.11, 187.12, 190.08, 192, 193.05,
296/193.11, 181.5; 280/183-185, DIG. 5, 1,
280/16, 82, 88, 90, 14, 756; 180/233, 908,
180/89.1, 89.11, 6.5
CPC B62D 35/00; B62D 39/00; B62D 47/00;
B62D 47/003; B62D 63/02; B62D 33/0617;
B62D 33/00; A01B 59/02; B60L 2200/22;
B60Y 2200/86; B60Y 2200/91; B60R 21/13
See application file for complete search history.

(56) **References Cited**

U.S. PATENT DOCUMENTS

D555,036 S * 11/2007 Eck D12/87
D604,201 S * 11/2009 Kawaguchi D12/14
D631,395 S * 1/2011 Tandrup D12/14

D631,792 S * 2/2011 Sanschagrin D12/14
D633,006 S * 2/2011 Sanschagrin D12/1
D636,295 S * 4/2011 Eck D12/1
D642,493 S * 8/2011 Goebert D12/87
D709,798 S * 7/2014 Matsumura D12/14
D717,695 S * 11/2014 Matsumura D12/14
D737,724 S * 9/2015 Schroeder D12/14
2011/0115259 A1 * 5/2011 Mizuta B62D 25/12
296/193.11
2013/0087395 A1 * 4/2013 Kaku B60N 3/02
180/68.1
2013/0087403 A1 * 4/2013 Ito F16H 57/0416
180/339
2014/0144719 A1 * 5/2014 Morgan B60K 1/00
180/65.31

* cited by examiner

Primary Examiner — T. Chase Nelson
Assistant Examiner — Ania Aman

(57) **CLAIM**

The ornamental design for a front structure of utility vehicle,
as shown and described.

DESCRIPTION

FIG. 1 is a front elevational view of a front structure of utility vehicle showing our new design;
FIG. 2 is a rear elevational view thereof;
FIG. 3 is a left side elevational view thereof;
FIG. 4 is a right side elevational view thereof;
FIG. 5 is a top plan view thereof;
FIG. 6 is a bottom plan view thereof;
FIG. 7 is a front and right-side isometric view thereof; and,
FIG. 8 is a rear and right-side isometric view thereof.
The claimed design is for a front structure of utility vehicle, the portions of which are dark-gray-colored in the drawings, and the light-grayed-out portions depict environmental subject matter only and form no part of the claimed design. The dark and light grayed surfaces do not represent a color nor a pattern but are intended to represent shading on the surface of the drawings.

1 Claim, 8 Drawing Sheets

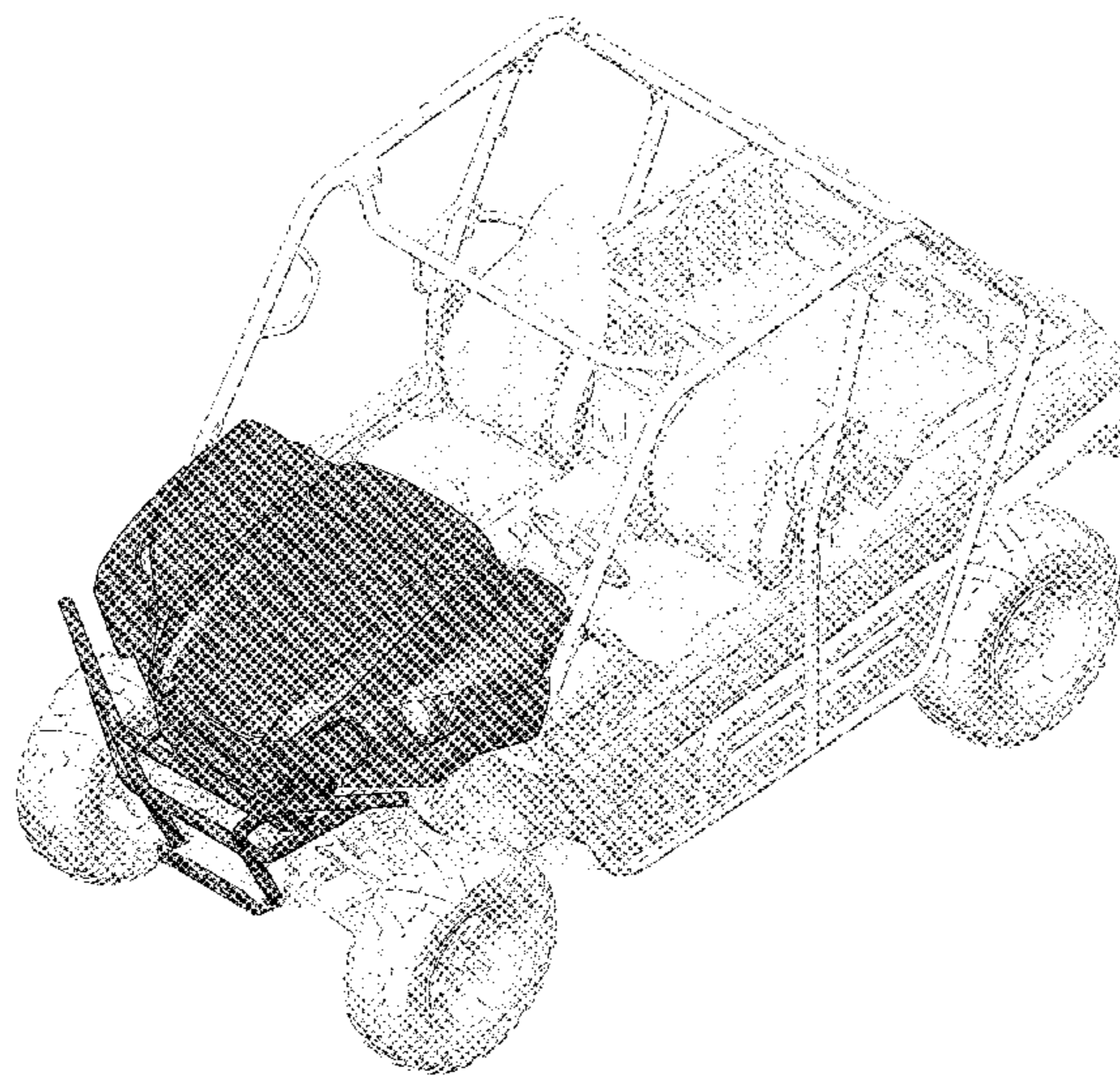

Fig. 1

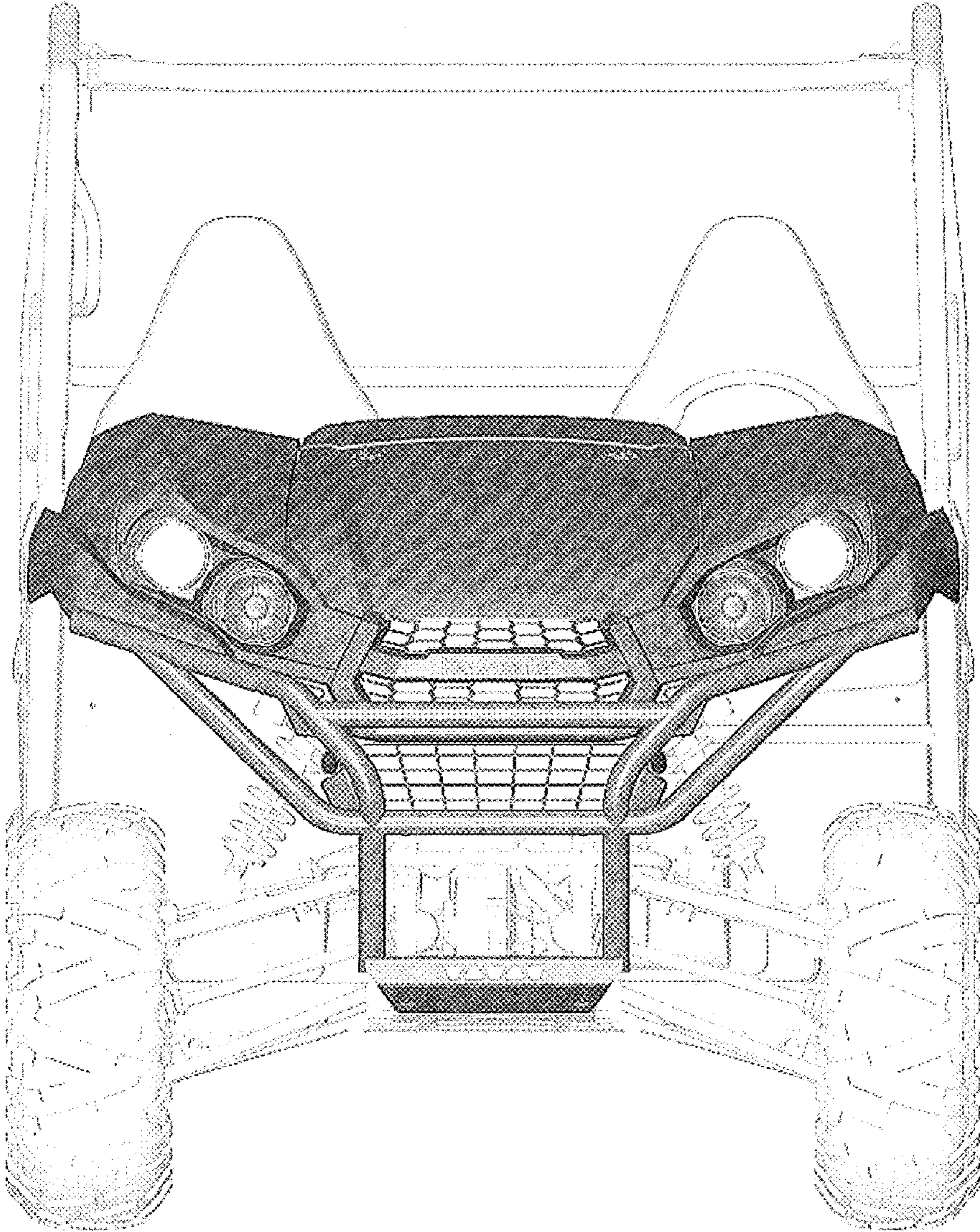
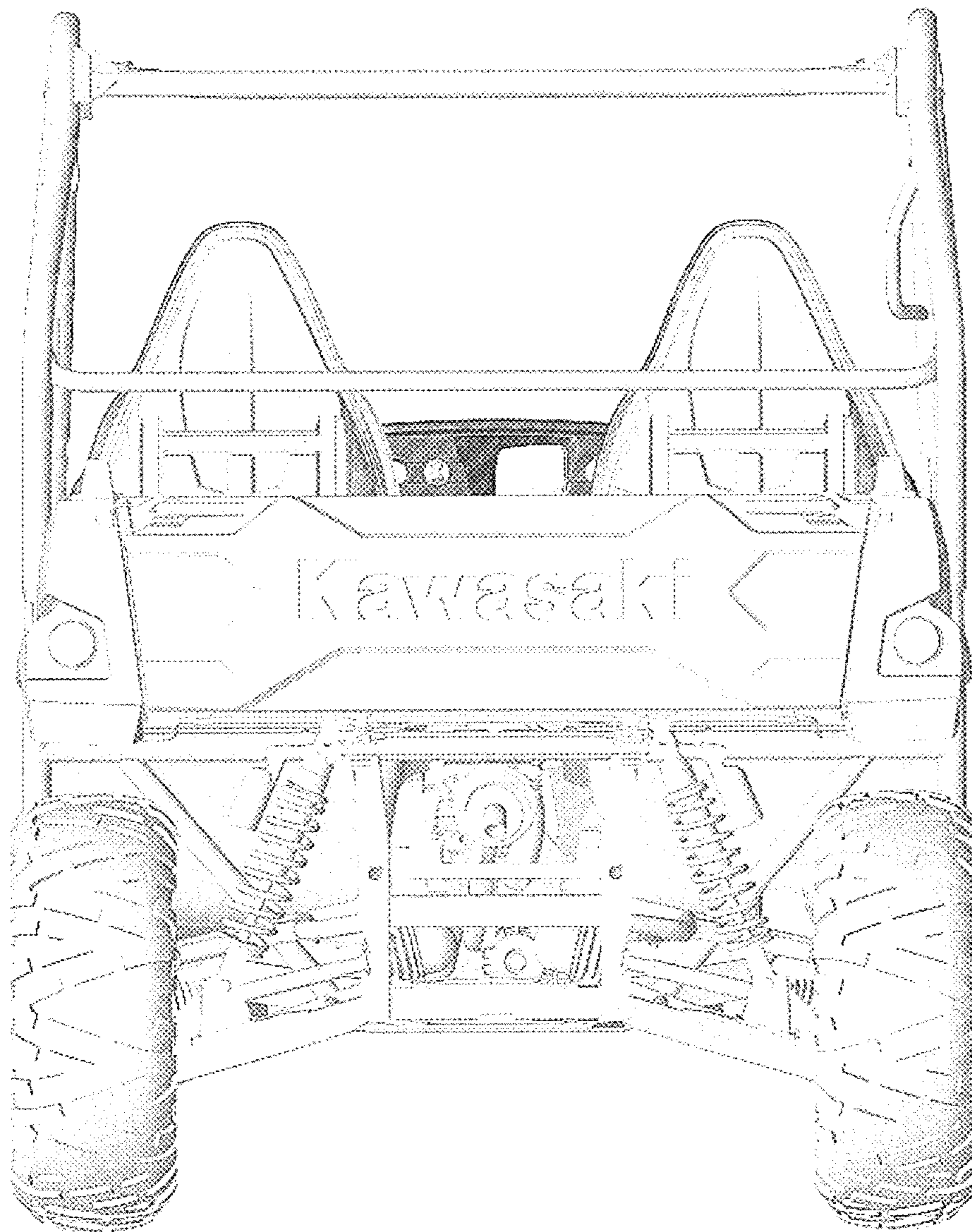

Fig. 2



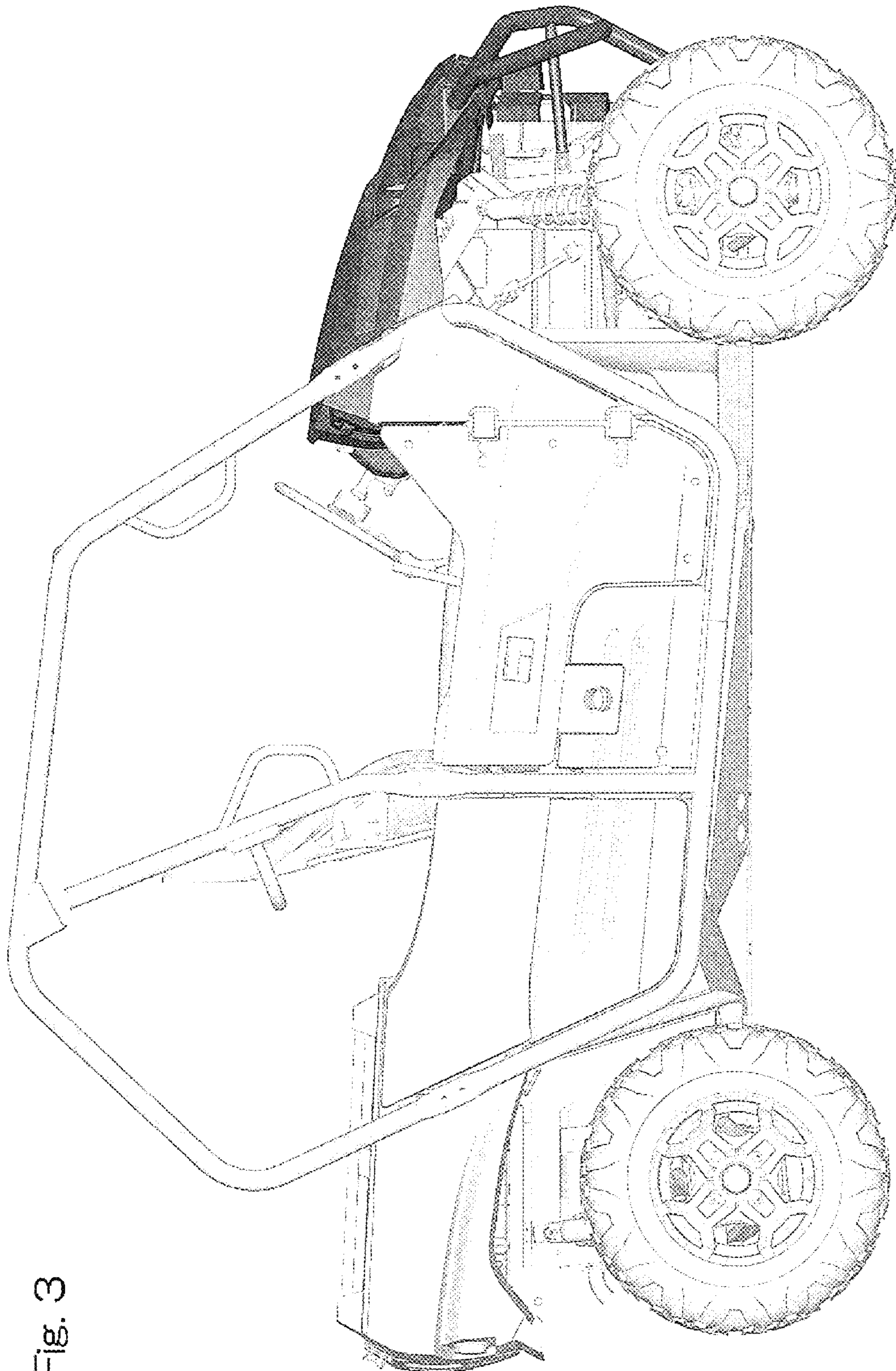

Fig. 3

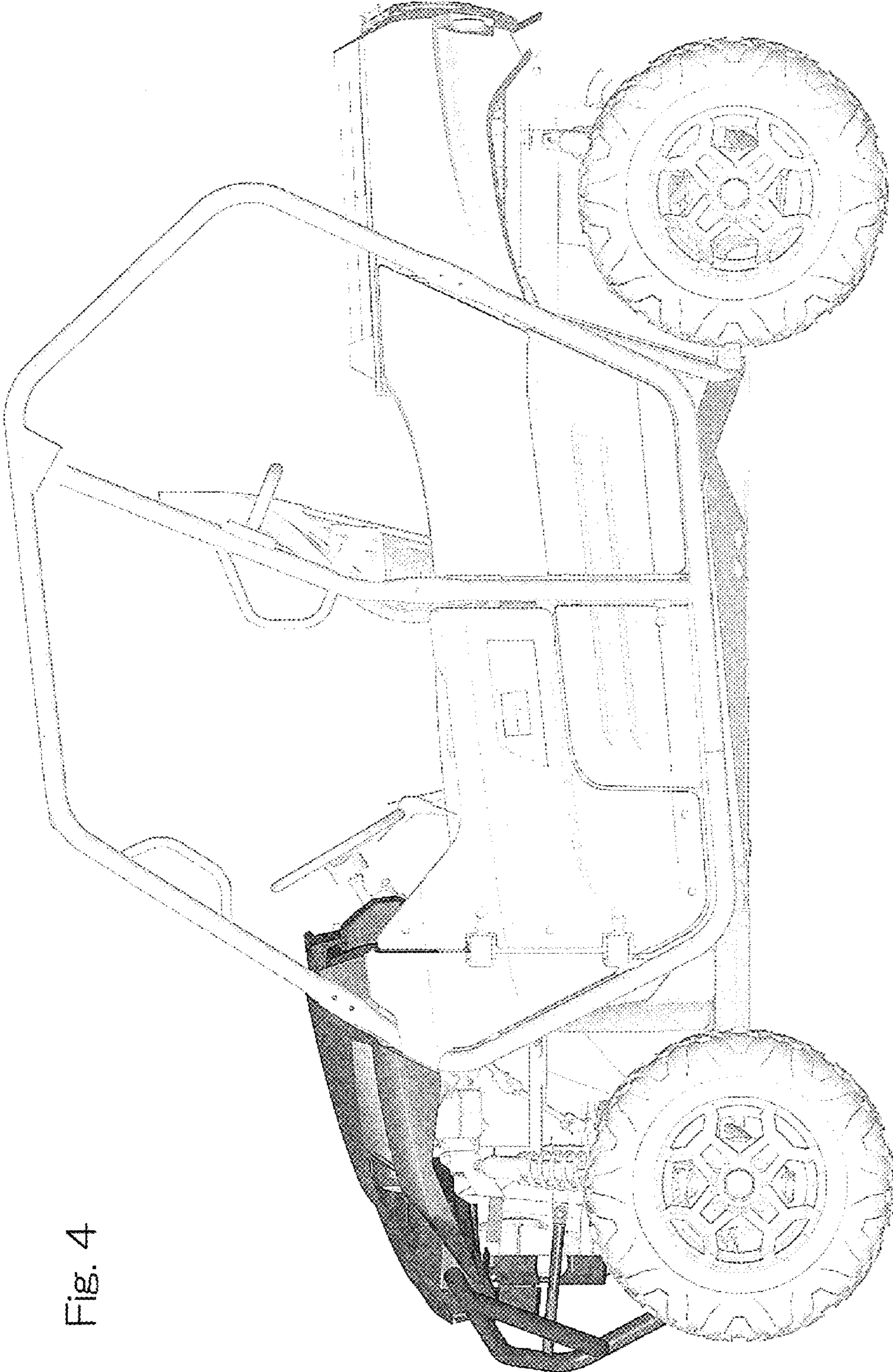

Fig. 4

Fig. 5

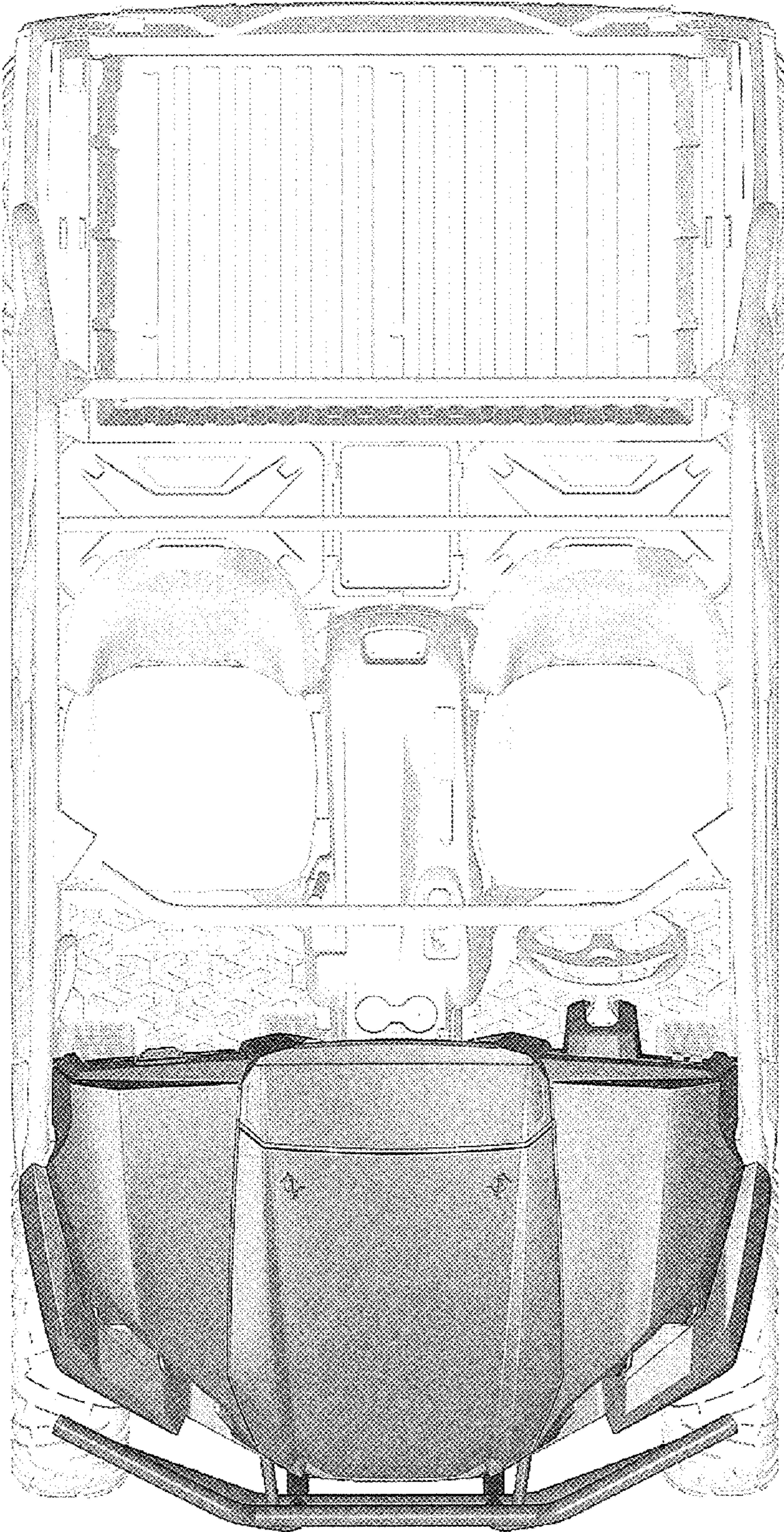
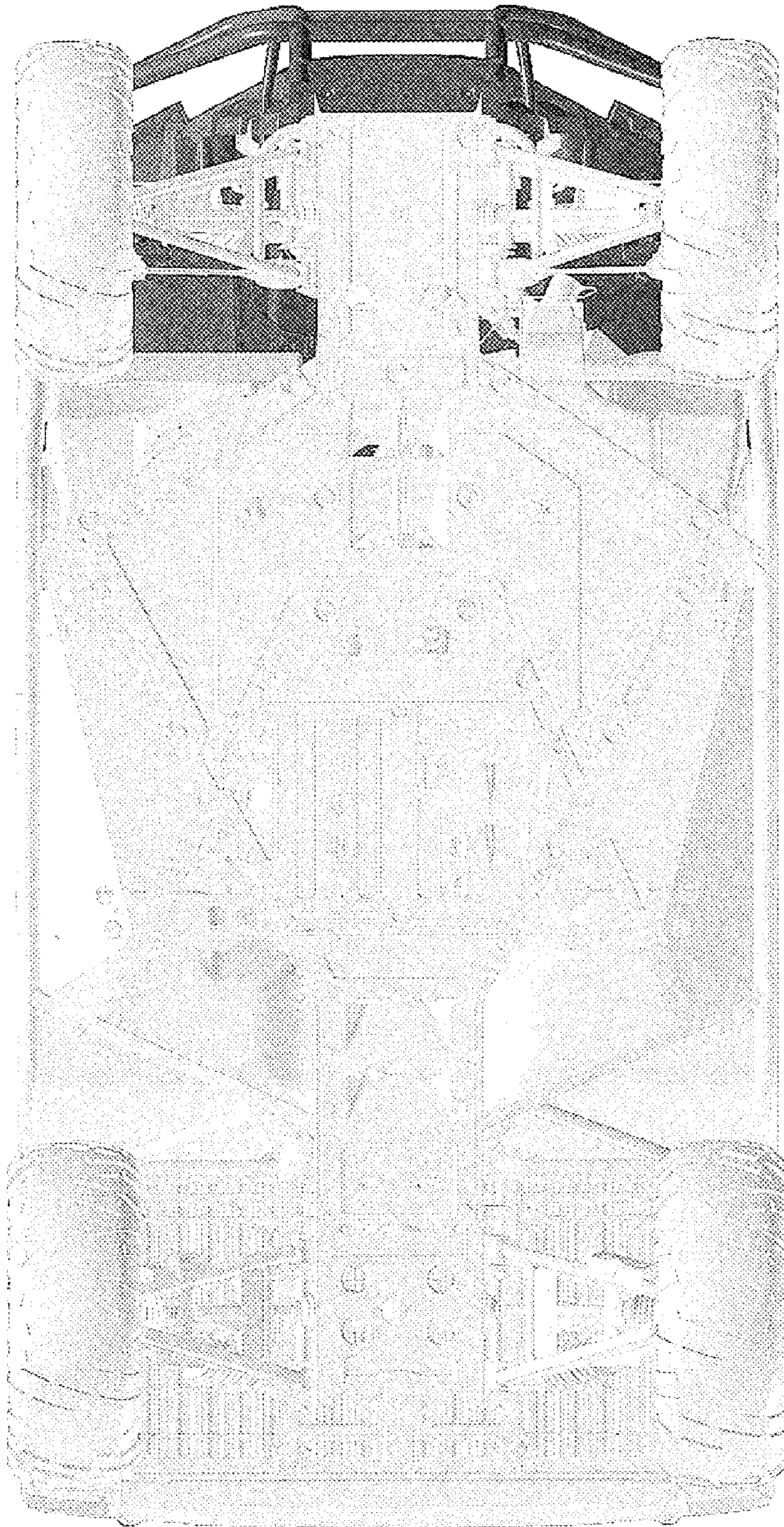

Fig. 6



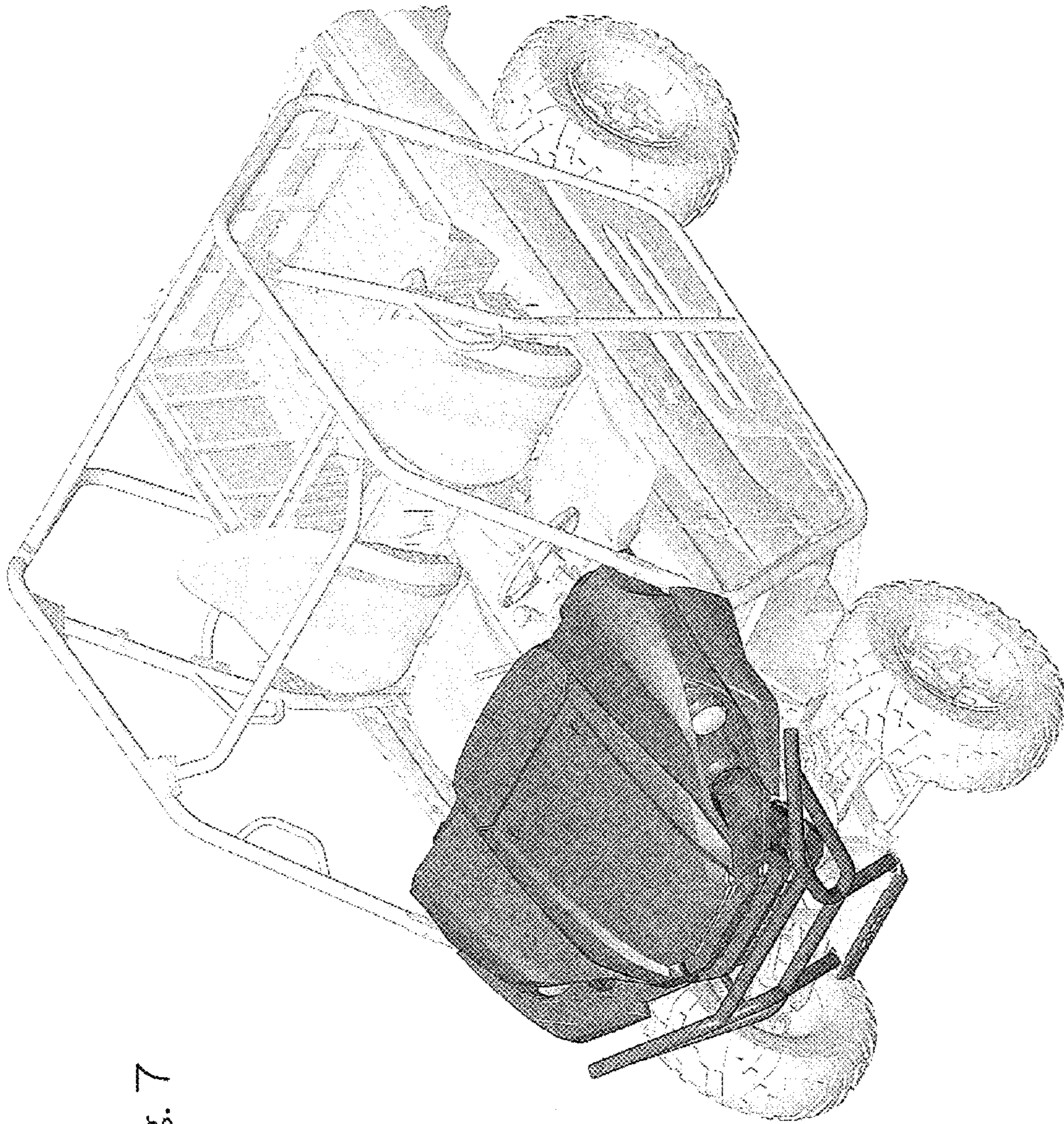

Fig. 7

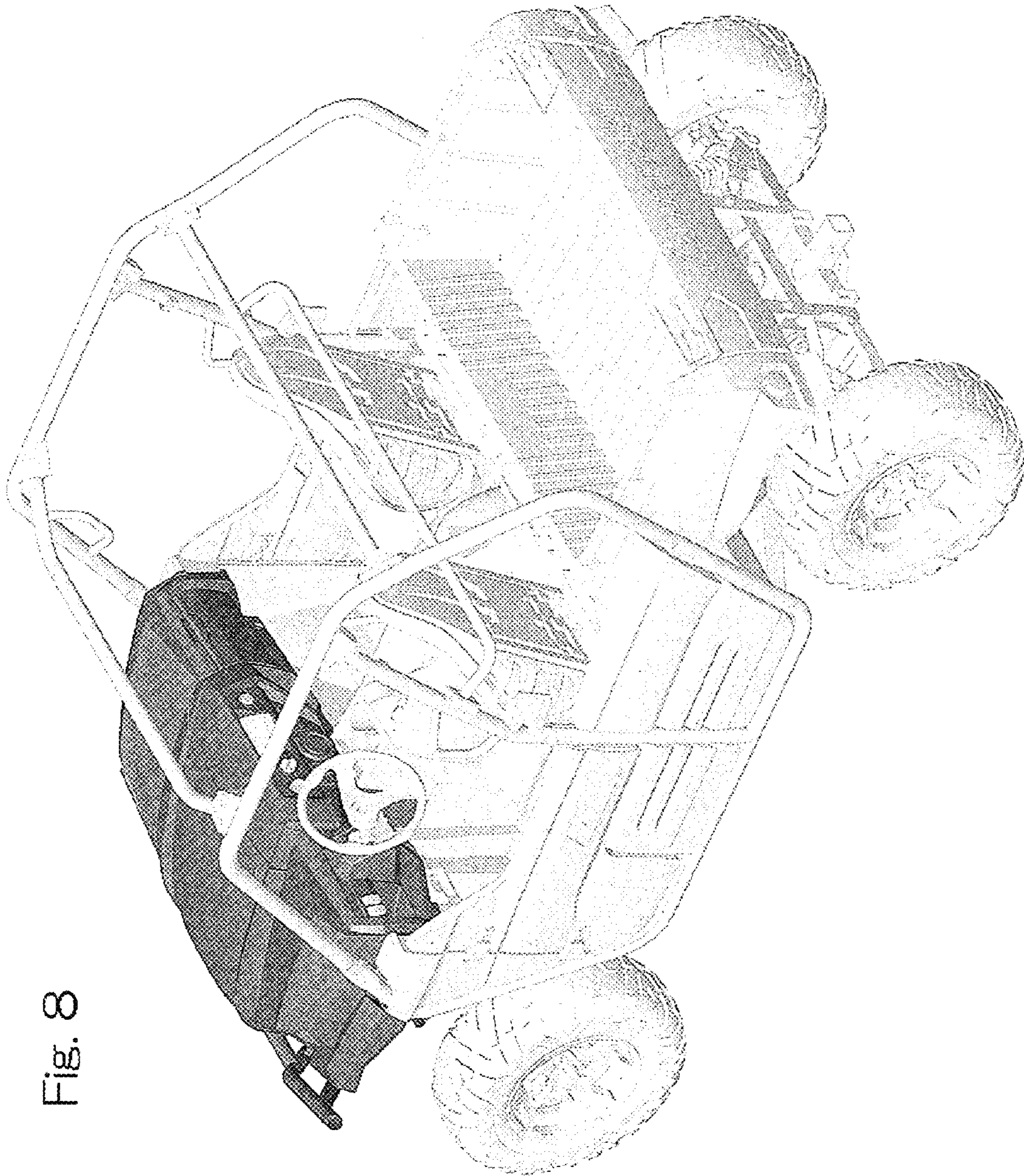

Fig. 8