



US00D762500S

(12) **United States Design Patent**
Hays

(10) **Patent No.:** **US D762,500 S**
(45) **Date of Patent:** **** Aug. 2, 2016**

(54) **PRESENCE SENSOR DEVICE**
(71) Applicant: **Hogman-Outdoors, LLC**, Cypress, TX (US)
(72) Inventor: **DeWayne L. Hays**, Cypress, TX (US)
(73) Assignee: **Hogman-Outdoors, LLC**, Cypress, TX (US)

(**) Term: **14 Years**

(21) Appl. No.: **29/524,439**

(22) Filed: **Apr. 20, 2015**

(51) **LOC (10) Cl.** **10-04**

(52) **U.S. Cl.**
USPC **D10/70**; D10/65; D10/106.7; D16/203

(58) **Field of Classification Search**
USPC D10/65, 70, 106.7; D16/201, 203, 208, D16/209
CPC G08B 13/19678; G08B 13/1968; G08B 13/19682; G08B 13/19684; G08B 13/19686; G08B 13/19689; G08B 13/19691; G08B 13/19695
See application file for complete search history.

(56) **References Cited**

U.S. PATENT DOCUMENTS

5,111,288 A * 5/1992 Blackshear G08B 13/19619 348/143
6,831,699 B2 * 12/2004 Chang G08B 13/19619 348/151
D552,649 S * 10/2007 Logan D16/200

D554,602 S * 11/2007 Hakoda D14/506
D690,344 S * 9/2013 Hollinger D16/200
D723,604 S * 3/2015 Mohan D16/203
D724,967 S * 3/2015 Miller D10/65
D731,579 S * 6/2015 Bart D16/203
D743,280 S * 11/2015 Miller D10/65
D745,910 S * 12/2015 Hollinger D16/203
9,204,622 B2 * 12/2015 Wong A01K 15/023
D749,661 S * 2/2016 Yang D16/203

* cited by examiner

Primary Examiner — Antoine D Davis

(74) *Attorney, Agent, or Firm* — Vinson & Elkins LLP

(57) **CLAIM**

The ornamental design for a presence sensor device, as shown and described.

DESCRIPTION

FIG. 1 is a perspective view of my presence sensor design.
FIG. 2 is a perspective view of my presence sensor design.
FIG. 3 is a perspective view of my presence sensor design.
FIG. 4 perspective view of my presence sensor design.
FIG. 5 is a left side view of my presence sensor design. The right side of my sensor is a mirror image of the left side and is not included.
FIG. 6 is a rear view of my presence sensor design.
FIG. 7 is a front view of my presence sensor design.
FIG. 8 is a top view of my presence sensor design; and,
FIG. 9 is a bottom view of my presence sensor design.
Broken lines in the figures indicate boundaries that form no part of the claimed design.

1 Claim, 2 Drawing Sheets

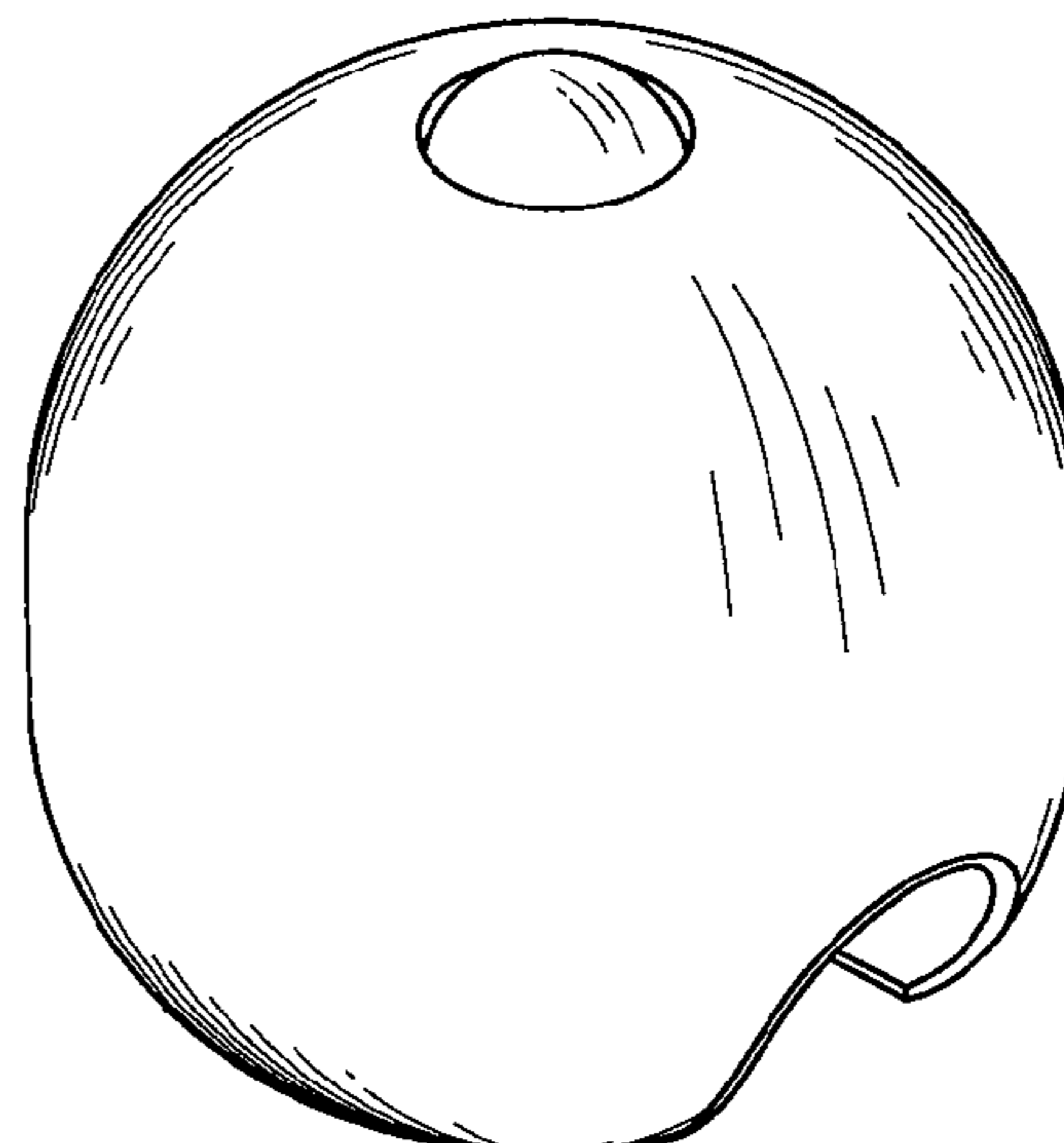
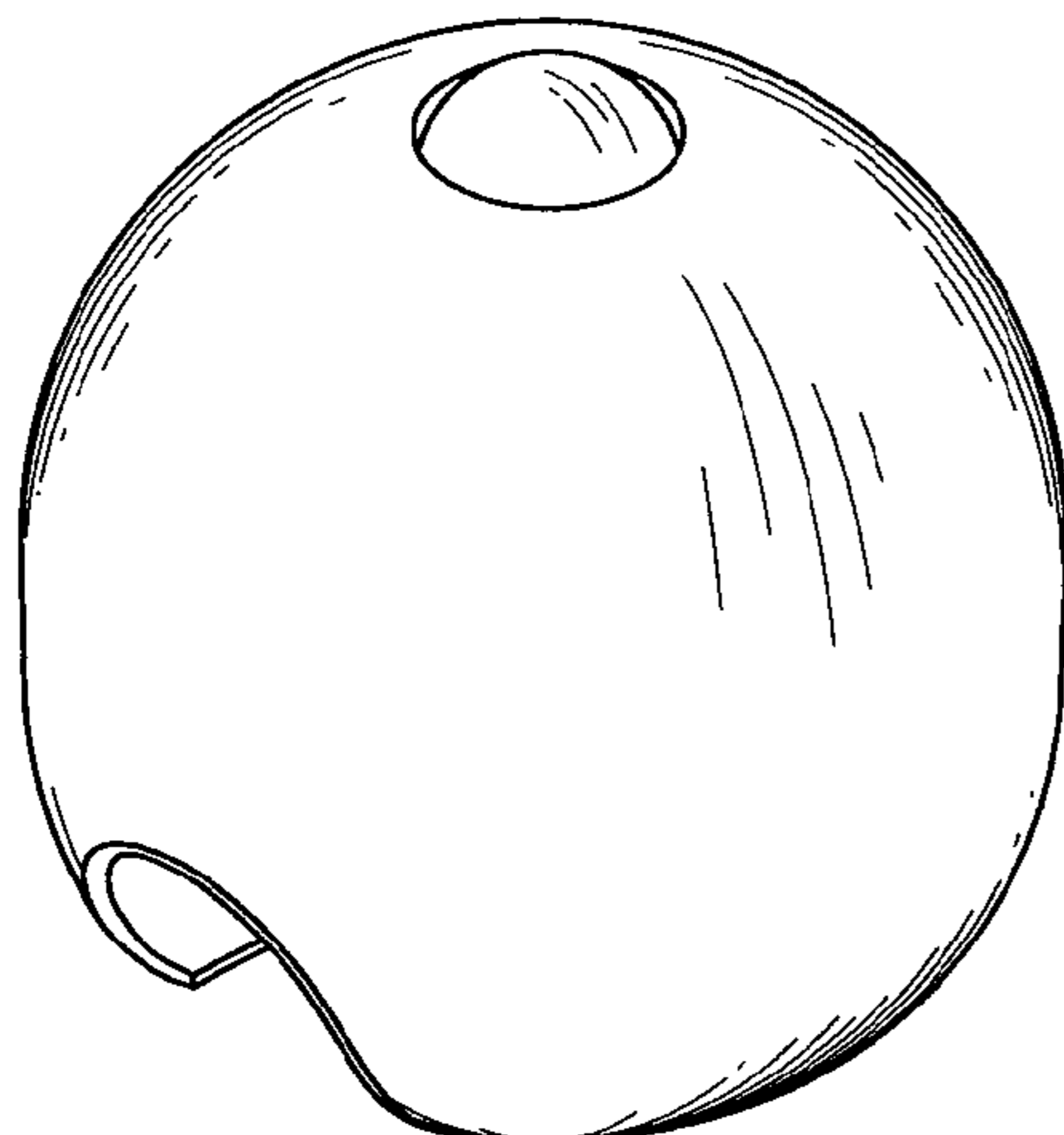

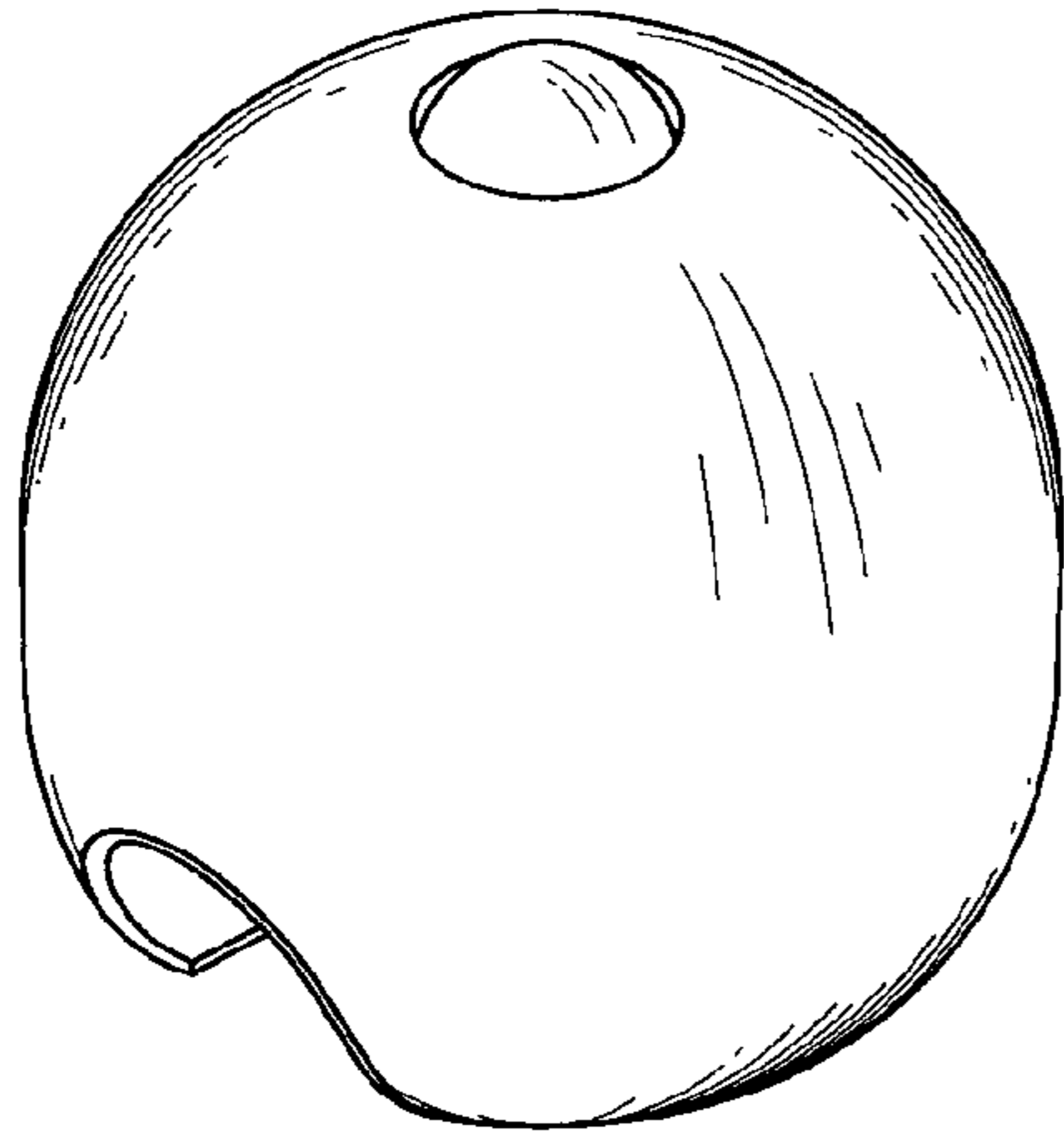

FIG. 1

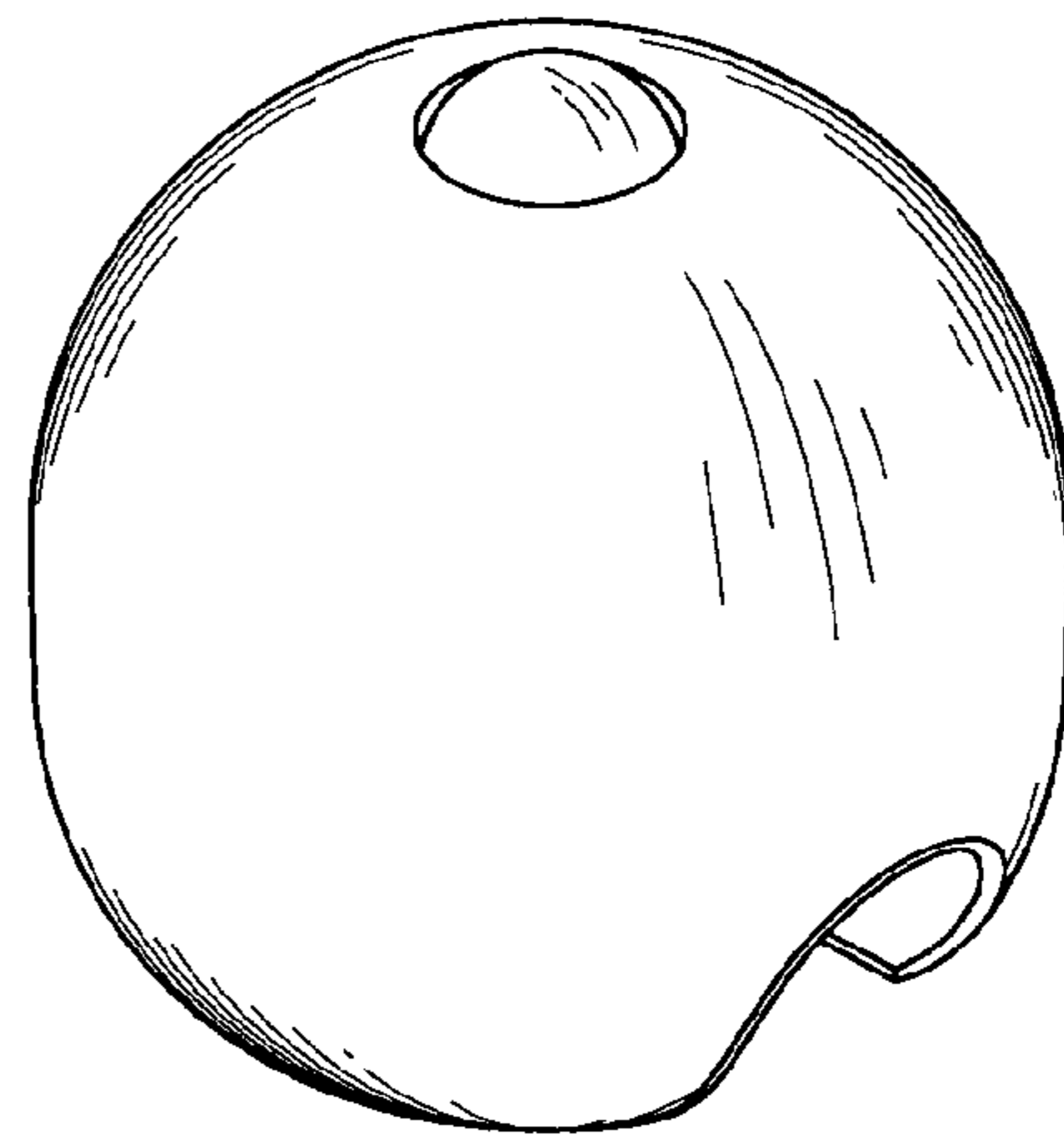

FIG. 2

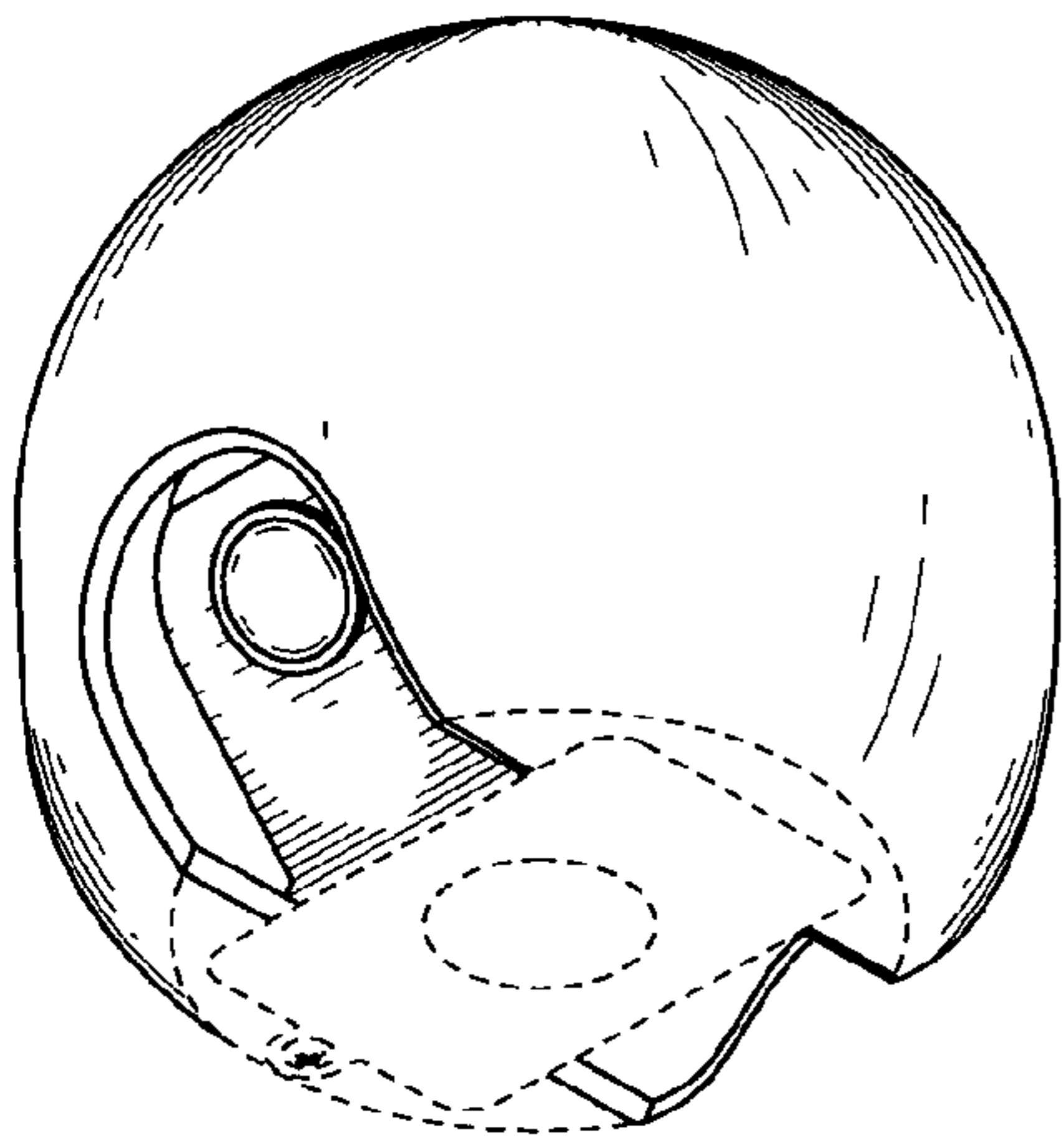

FIG. 3

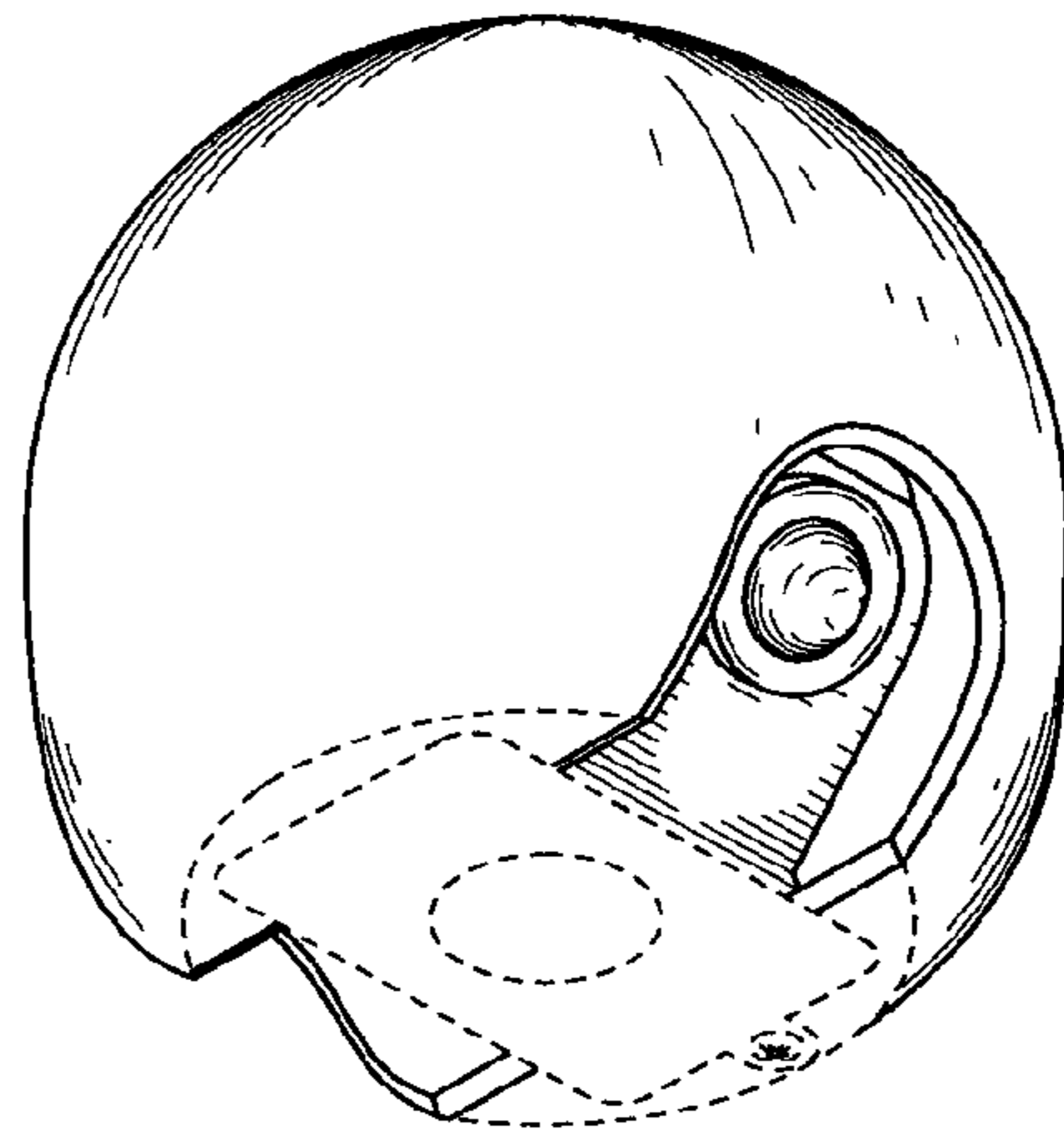

FIG. 4

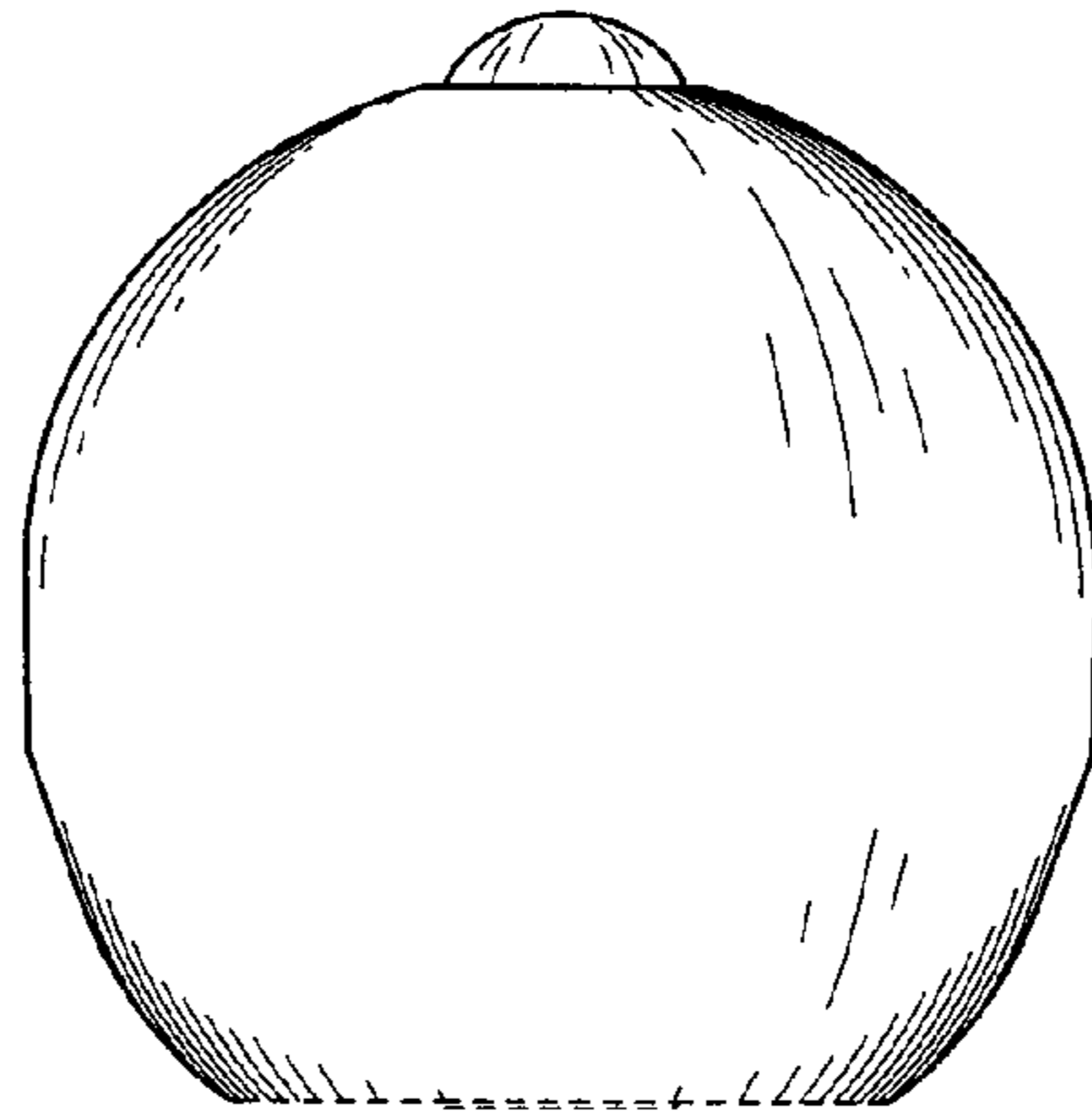

FIG. 5

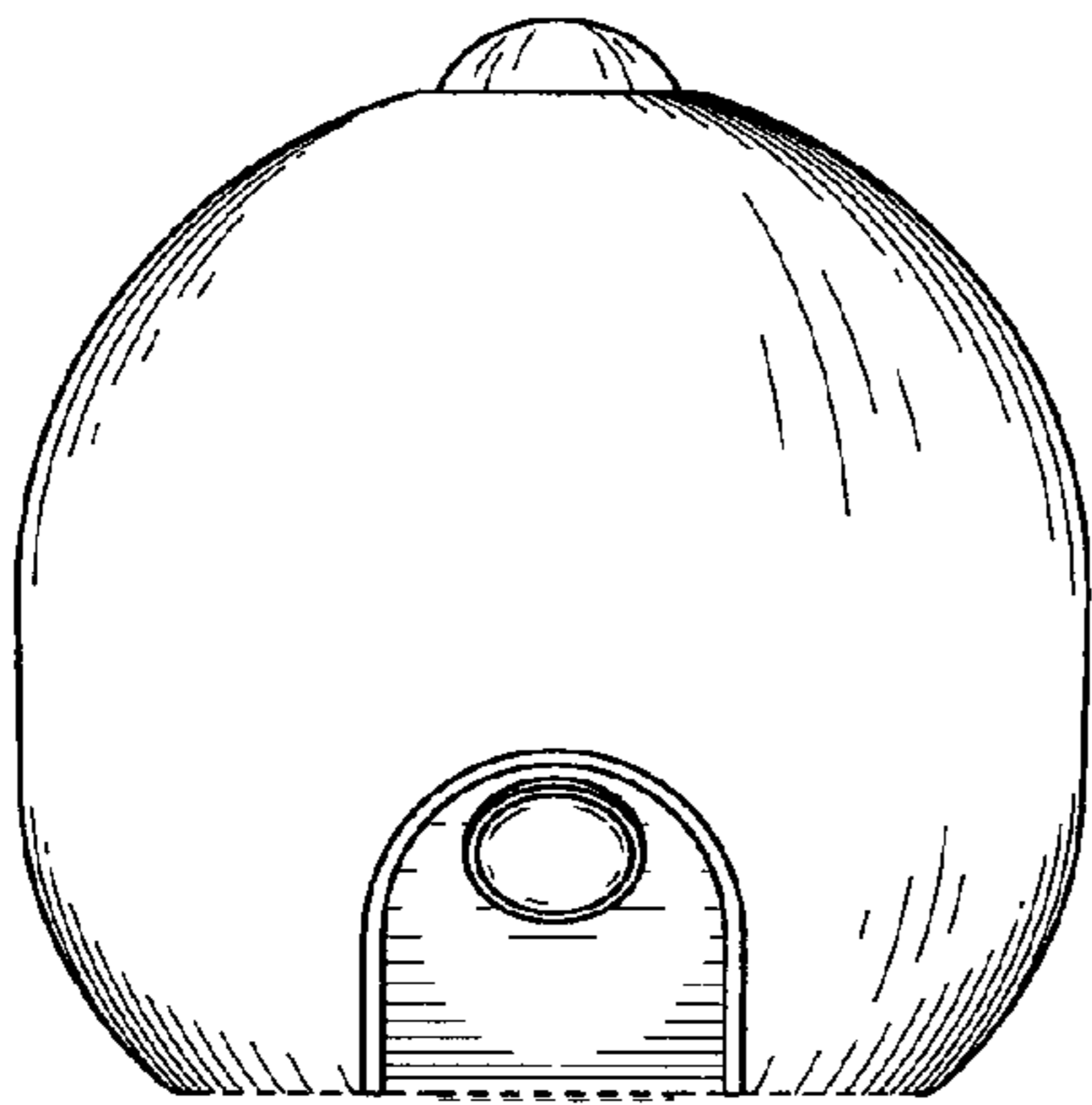

FIG. 6

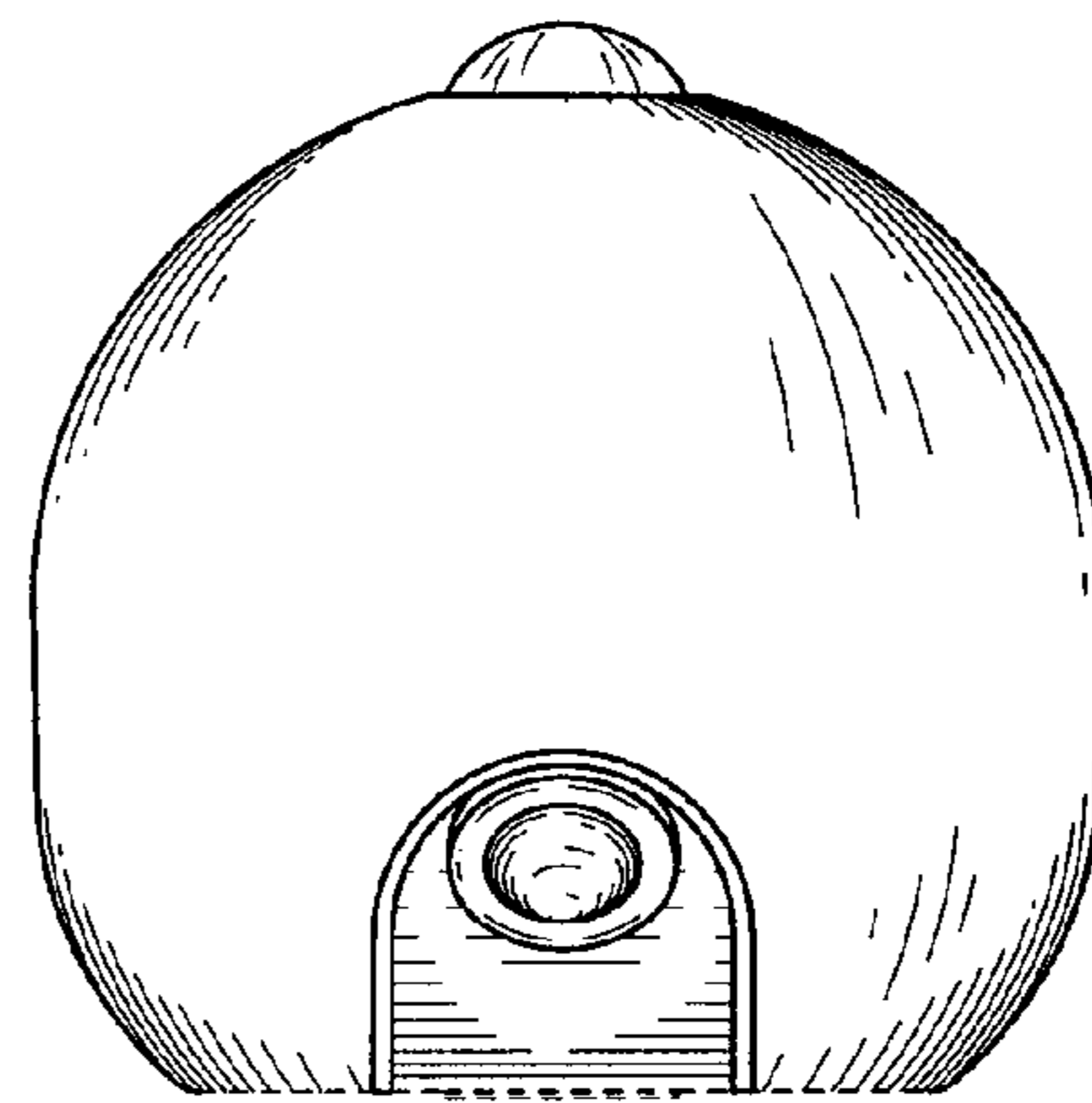

FIG. 7

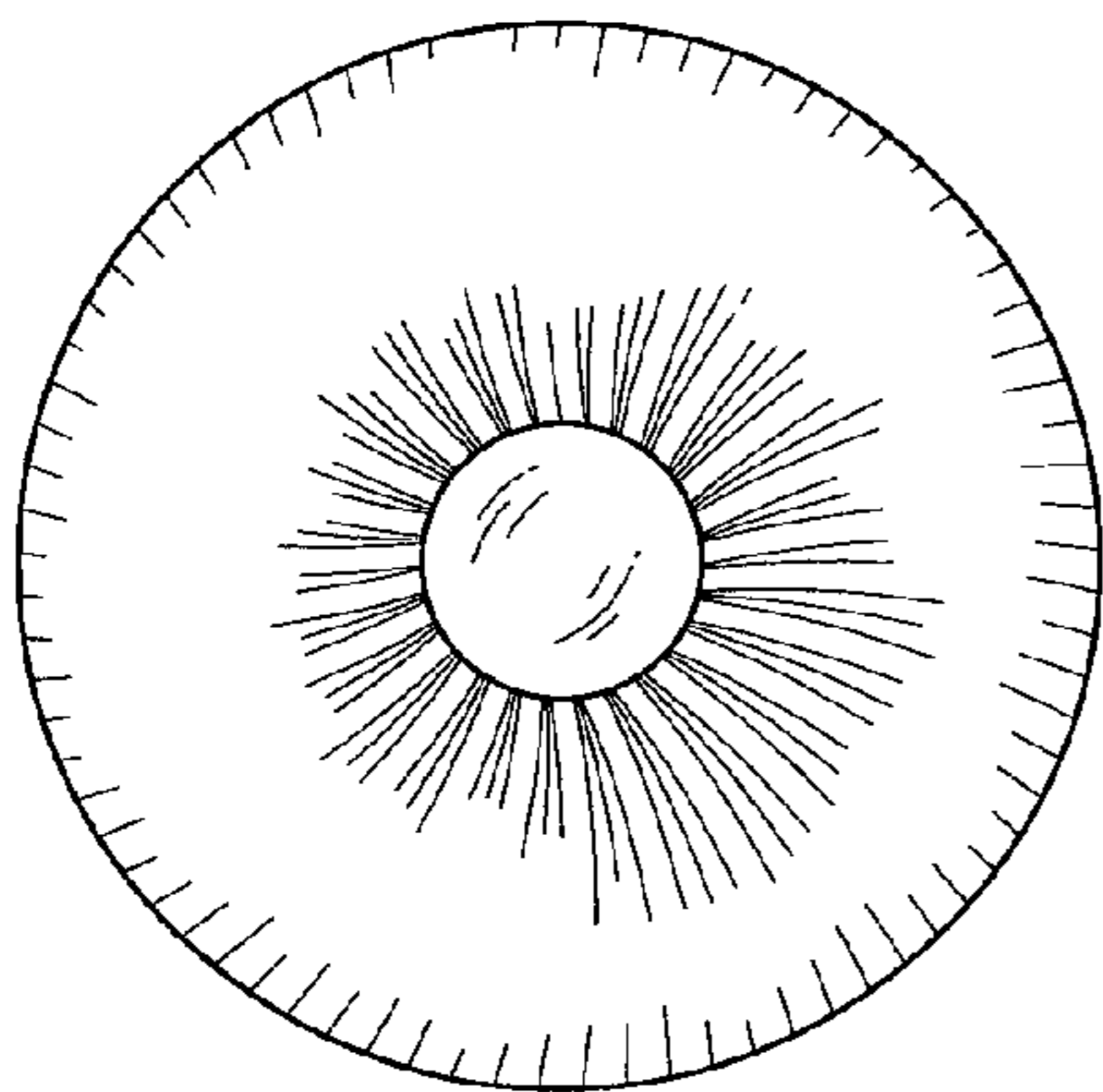

FIG. 8

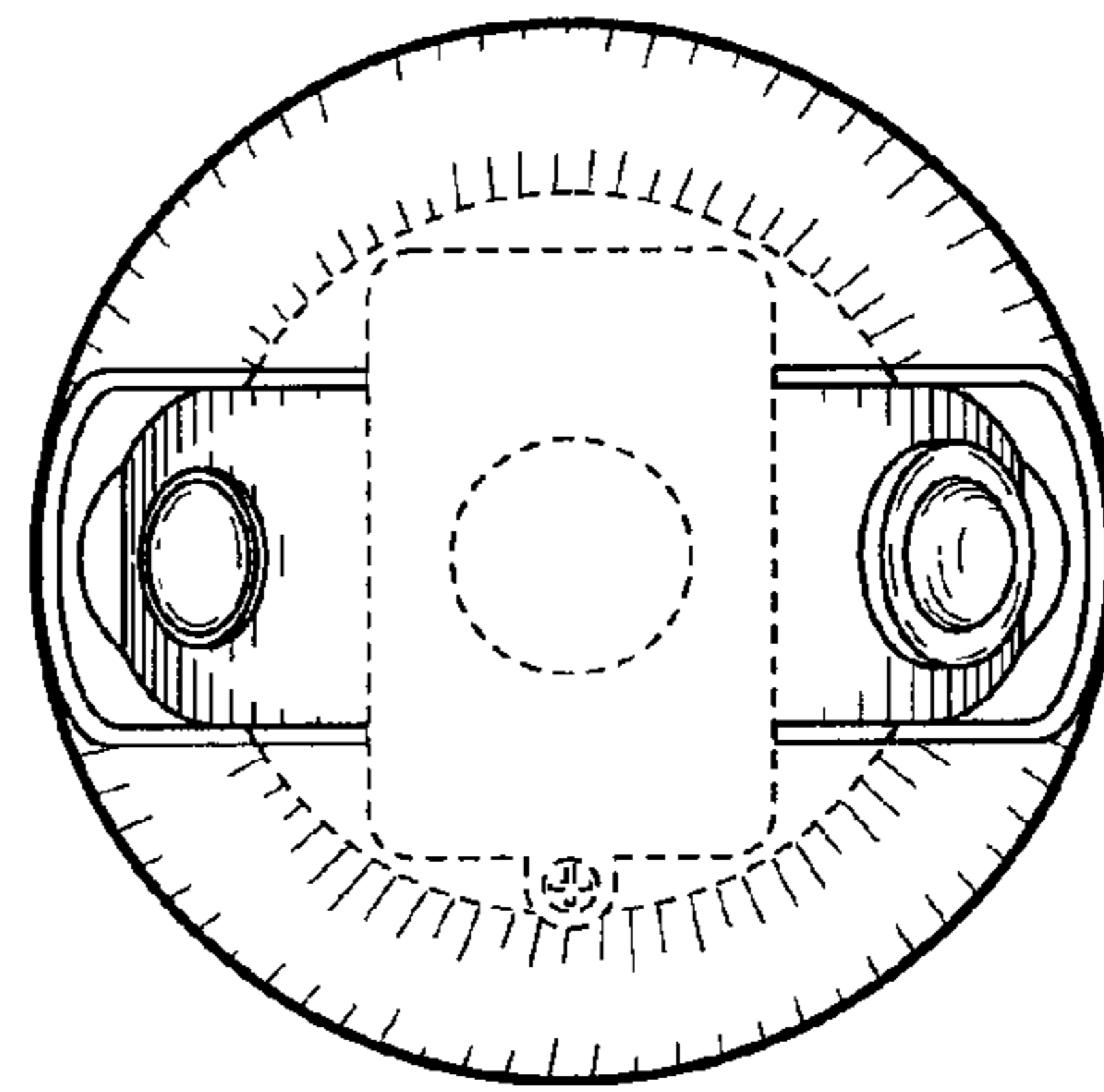

FIG. 9