

US00D762497S

(12) **United States Design Patent**
Tanaka et al.

(10) **Patent No.:** **US D762,497 S**

(45) **Date of Patent:** **** Aug. 2, 2016**

(54) **TEMPERATURE ADJUSTER**

(71) Applicant: **FUJI ELECTRIC CO., LTD.,**
Kawasaki-shi (JP)

(72) Inventors: **Yukio Tanaka**, Kawasaki (JP); **Shota Amano**, Kawasaki (JP)

(73) Assignee: **Fuji Electric Co., Ltd.**, Kawasaki-shi (JP)

(**) Term: **14 Years**

(21) Appl. No.: **29/525,707**

(22) Filed: **May 1, 2015**

(51) **LOC (10) Cl.** **10-04**

(52) **U.S. Cl.**
USPC **D10/50**

(58) **Field of Classification Search**
USPC D10/49-52
CPC H01H 2223/00; H01H 2223/002;
H01H 2223/003; H01H 2223/004; H01H
2223/006
See application file for complete search history.

(56) **References Cited**

U.S. PATENT DOCUMENTS

D271,569 S	*	11/1983	Lui	D10/49
D381,590 S	*	7/1997	Thoeni	D10/49
D489,276 S	*	5/2004	Kido	D10/125
D490,727 S	*	6/2004	Kido	D10/125
D574,738 S	*	8/2008	Khurana	D10/49

D597,864 S	*	8/2009	Sakuma	D10/50
D613,625 S	*	4/2010	Schneor	D10/49
D640,939 S	*	7/2011	Libman	D10/49
D677,587 S	*	3/2013	Mueller	D10/49
D705,091 S	*	5/2014	Andersson	D10/50

OTHER PUBLICATIONS

Fuji Electric Co., Ltd. (Oct. 27, 2014). Webpage showing claimed invention, located at <<http://www.fujielectric.co.jp/about/news/detail/2014/20141027140016650.html>> visited on Apr. 2, 2015. (5 pages).

* cited by examiner

Primary Examiner — Antoine D Davis

(74) *Attorney, Agent, or Firm* — Morrison & Foerster LLP

(57) **CLAIM**

We claim the ornamental design for a temperature adjuster, as shown and described.

DESCRIPTION

FIG. 1 is a perspective view of a temperature adjuster showing our new design;
FIG. 2 is a front view thereof;
FIG. 3 is a back view thereof;
FIG. 4 is a top view thereof;
FIG. 5 is a bottom view thereof;
FIG. 6 is a side view thereof;
FIG. 7 is a side view of the opposite side of FIG. 6;
FIG. 8 is a front view thereof, showing LCD during operation;
FIG. 9 is a front view thereof, showing LCD portion as a shaded area; and,
FIG. 10 is a partial expanded view of FIG. 6 (A-A portion).

1 Claim, 5 Drawing Sheets

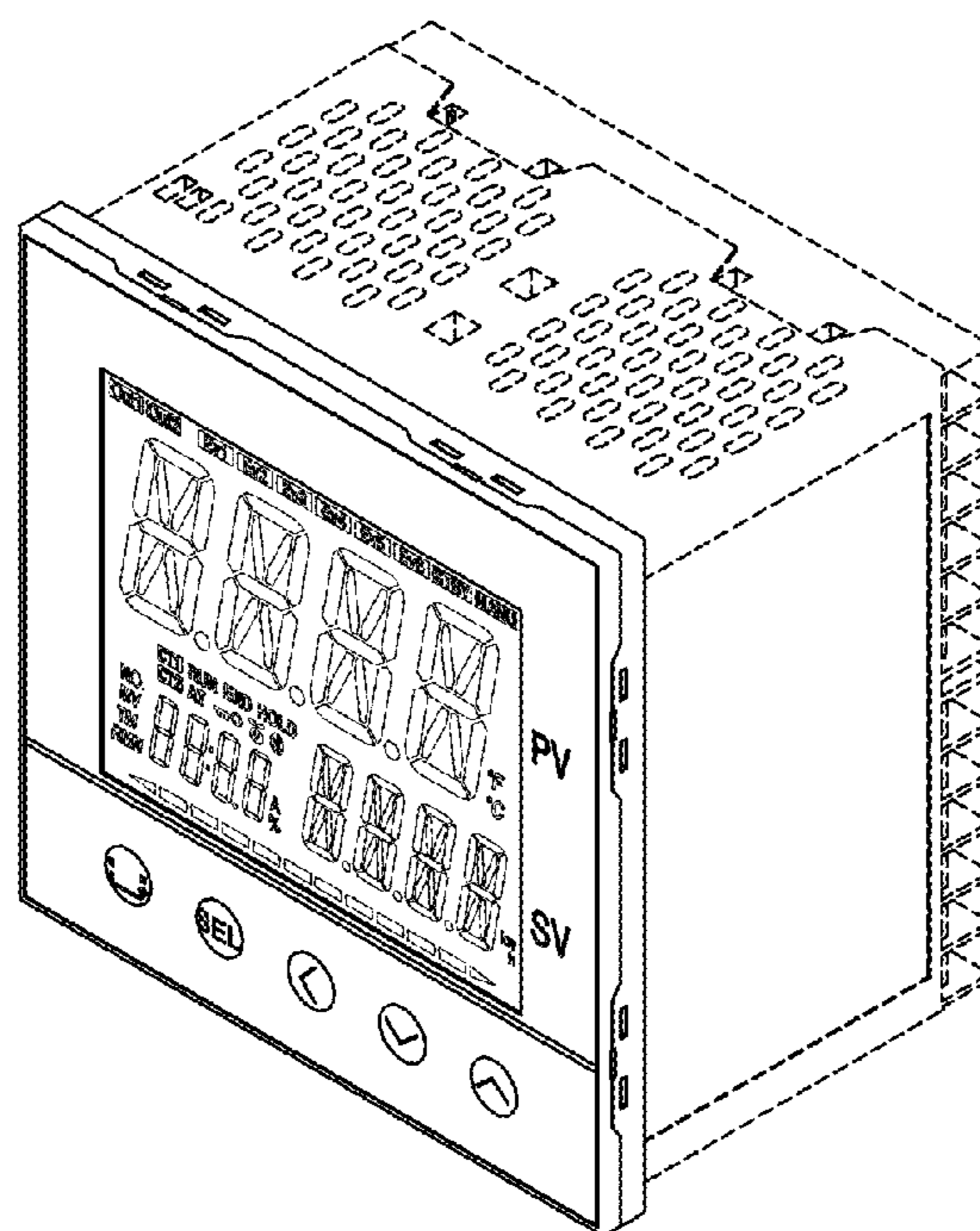

FIG. 1

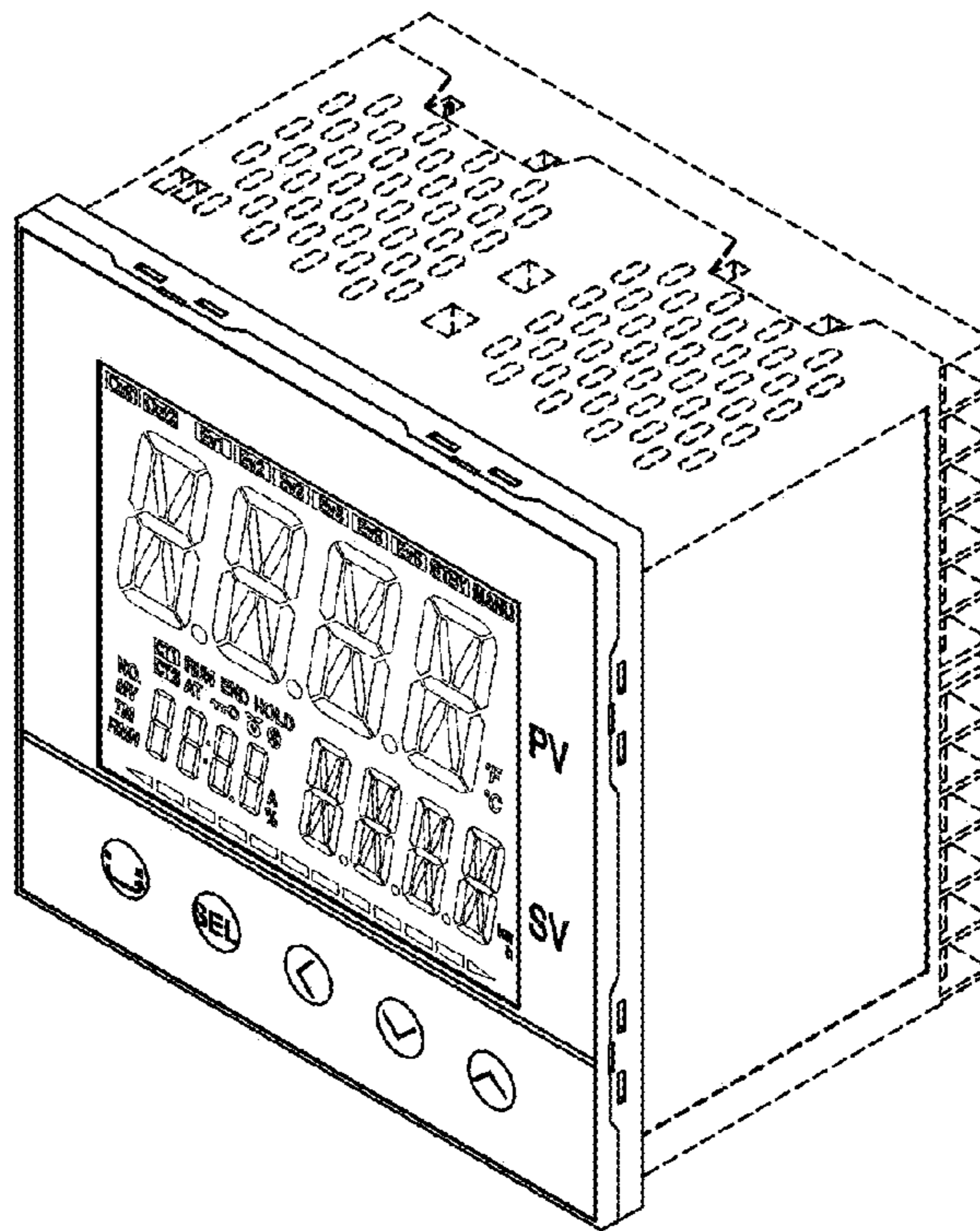

FIG. 2

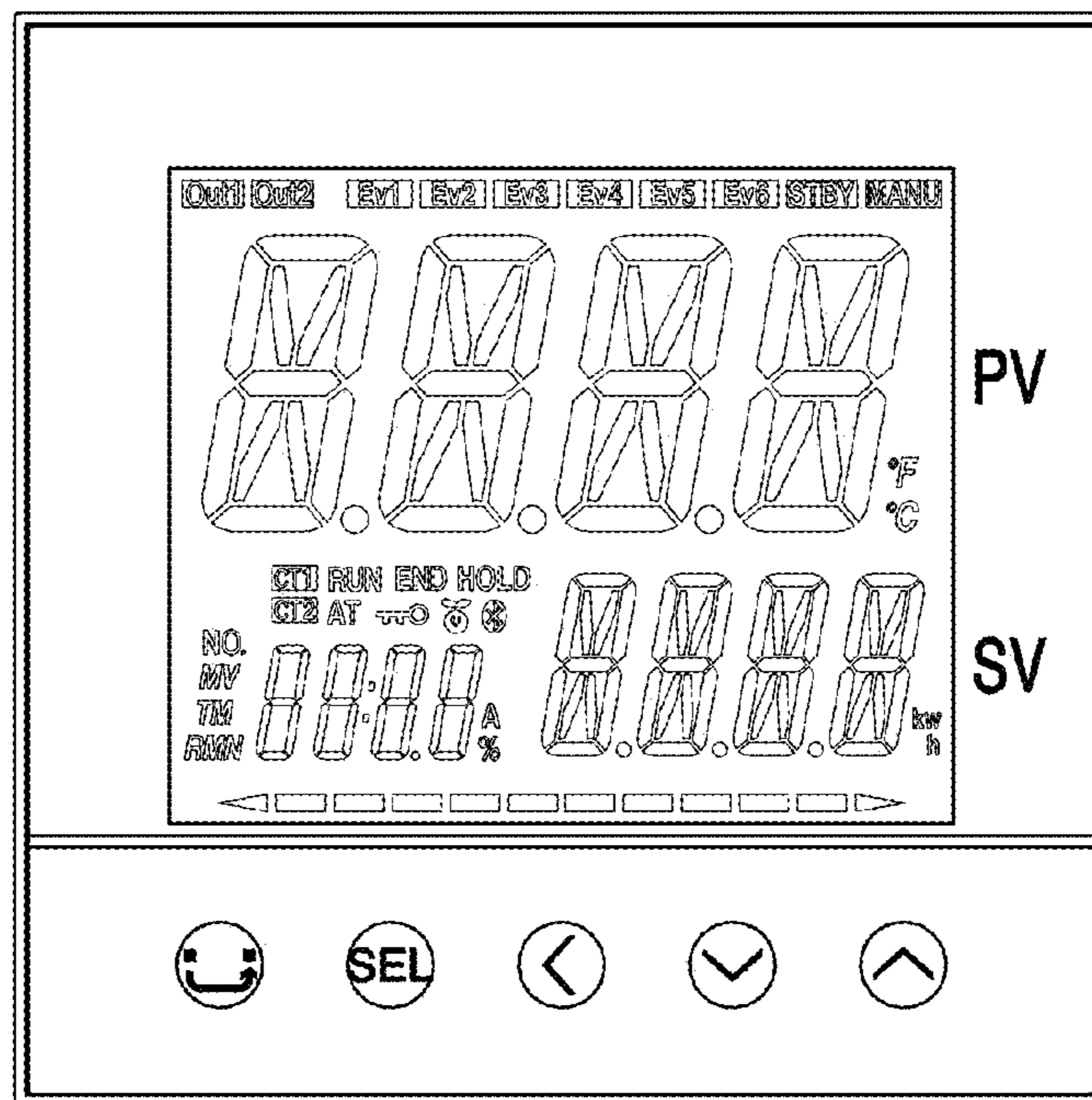

FIG. 3

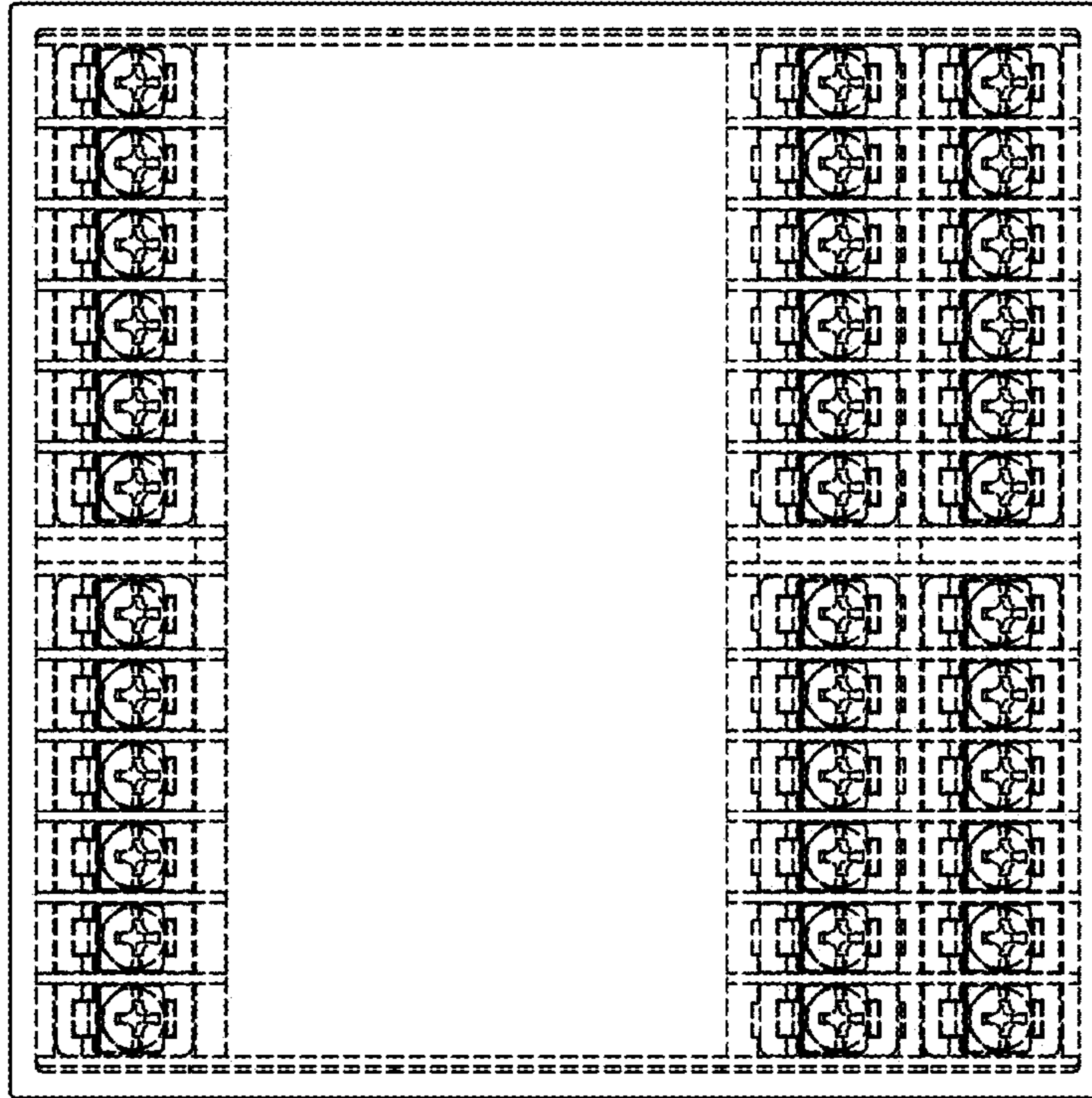

FIG. 4

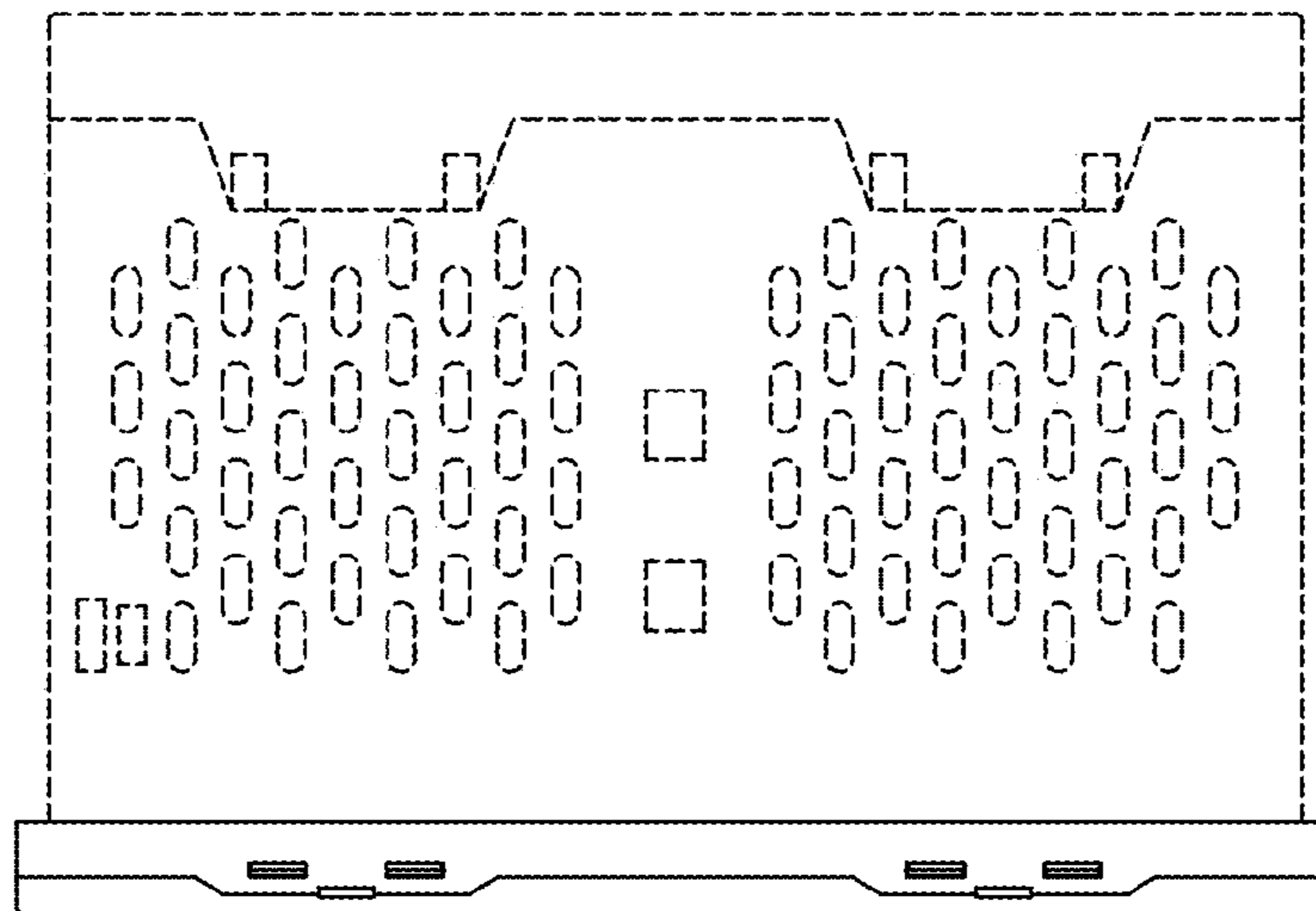

FIG. 5

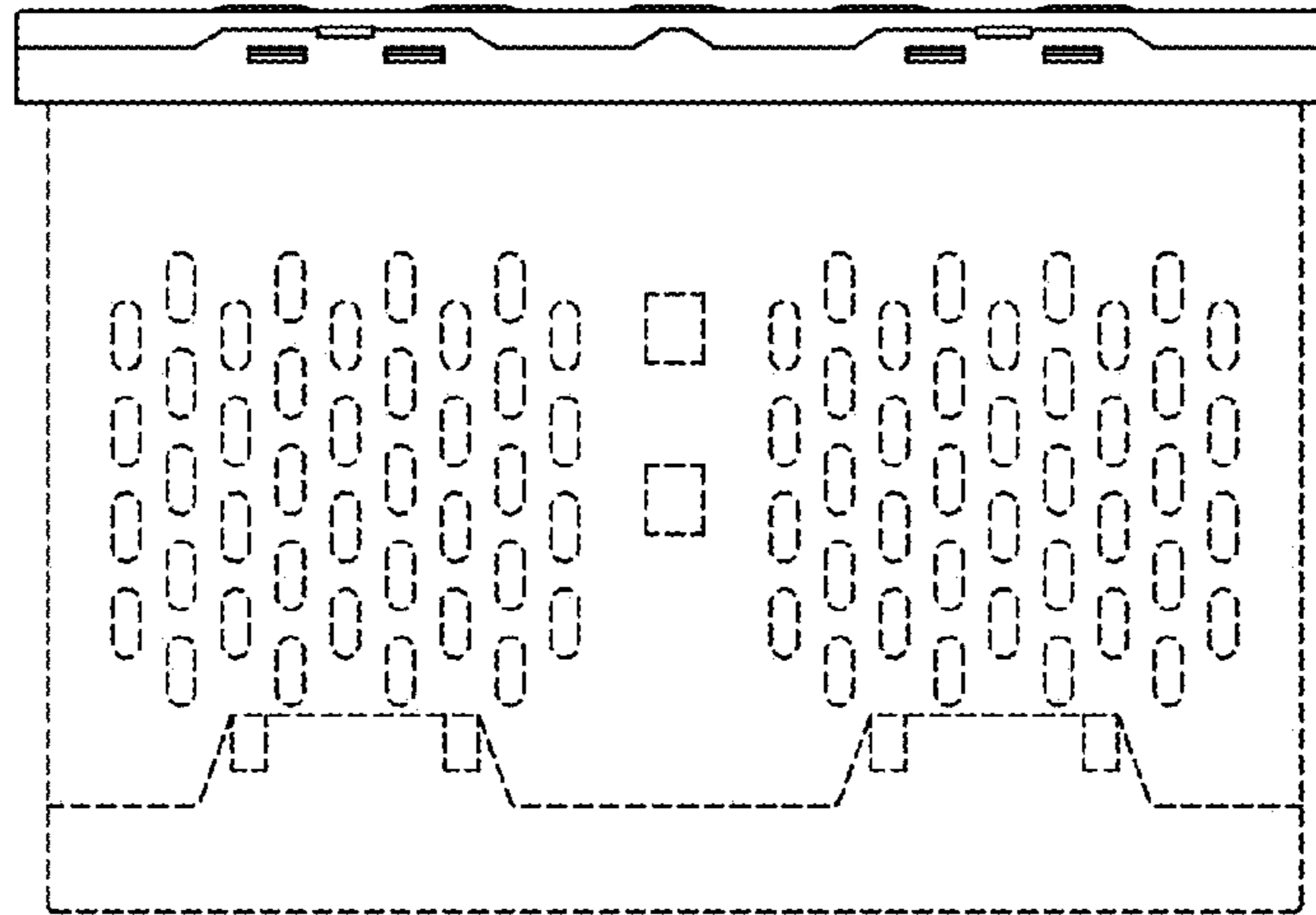

FIG. 6

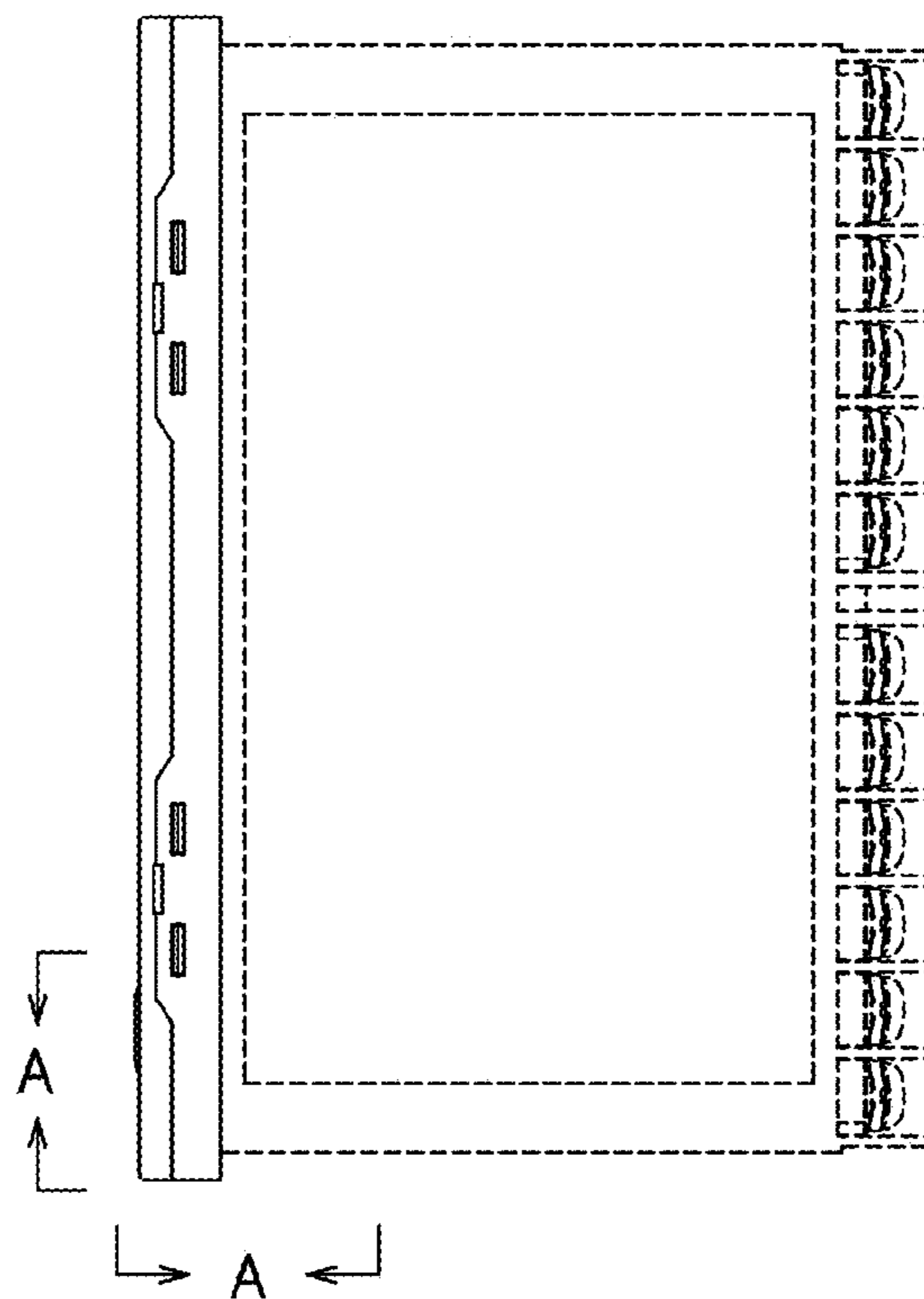

FIG. 7

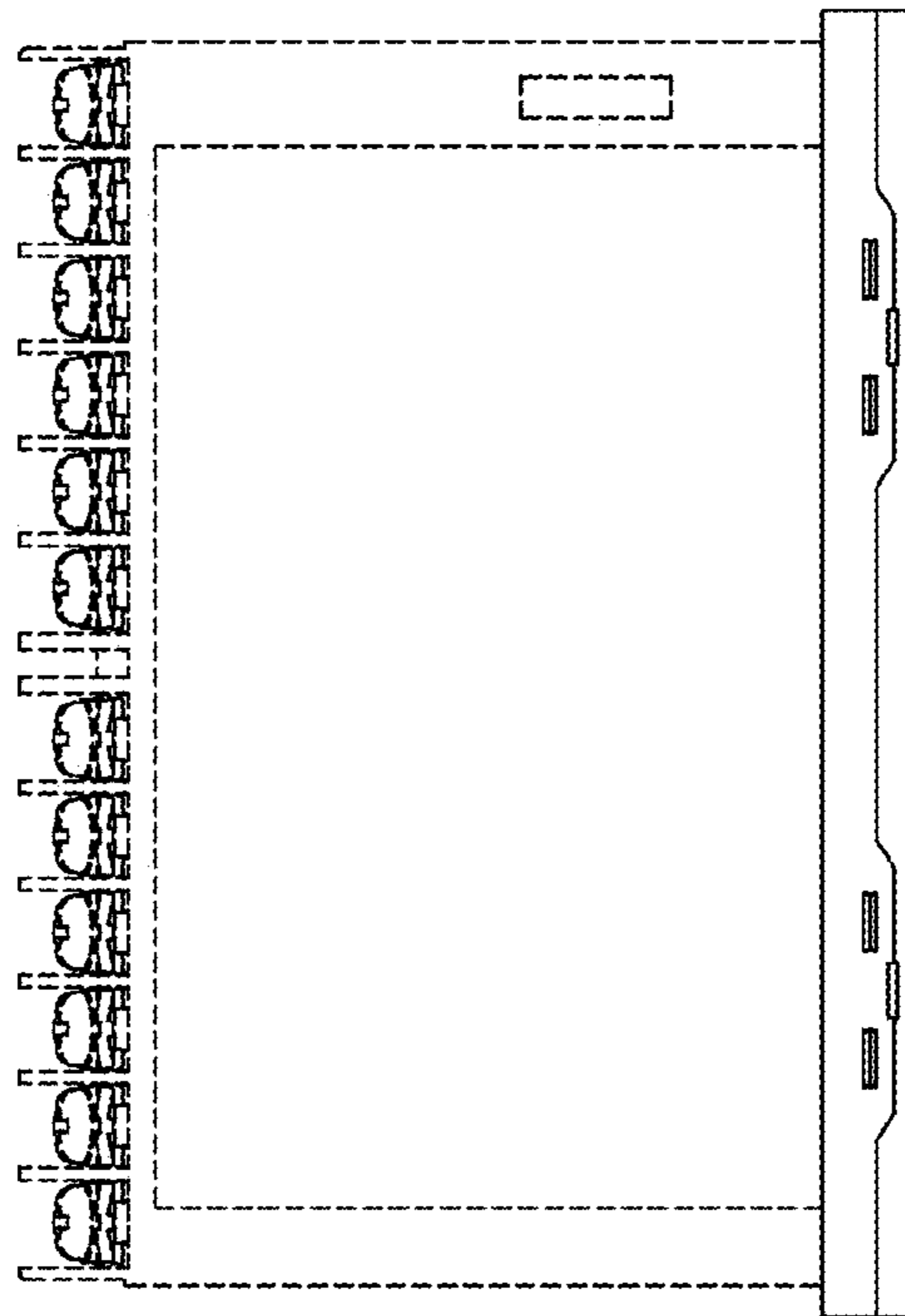

FIG. 8

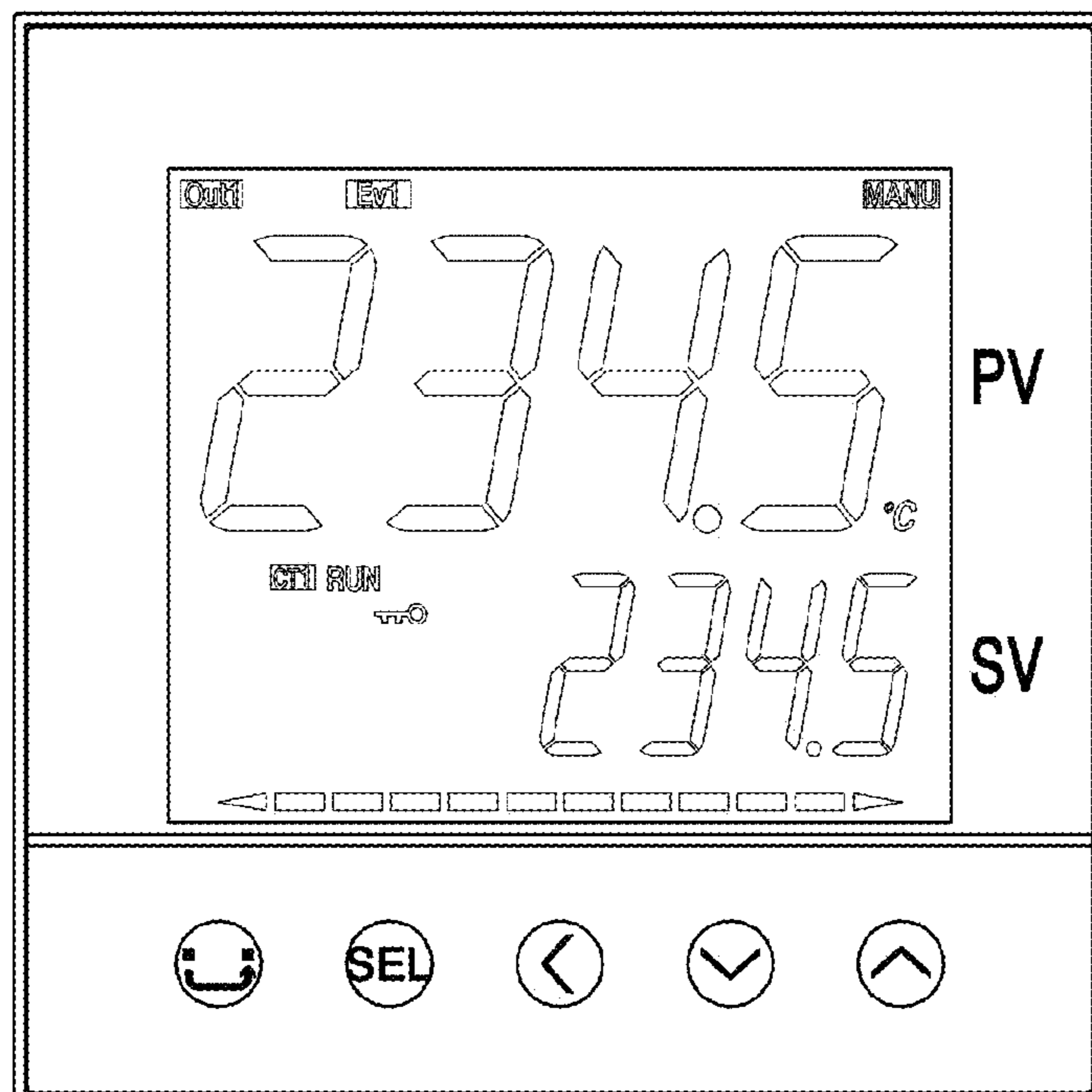

FIG. 9

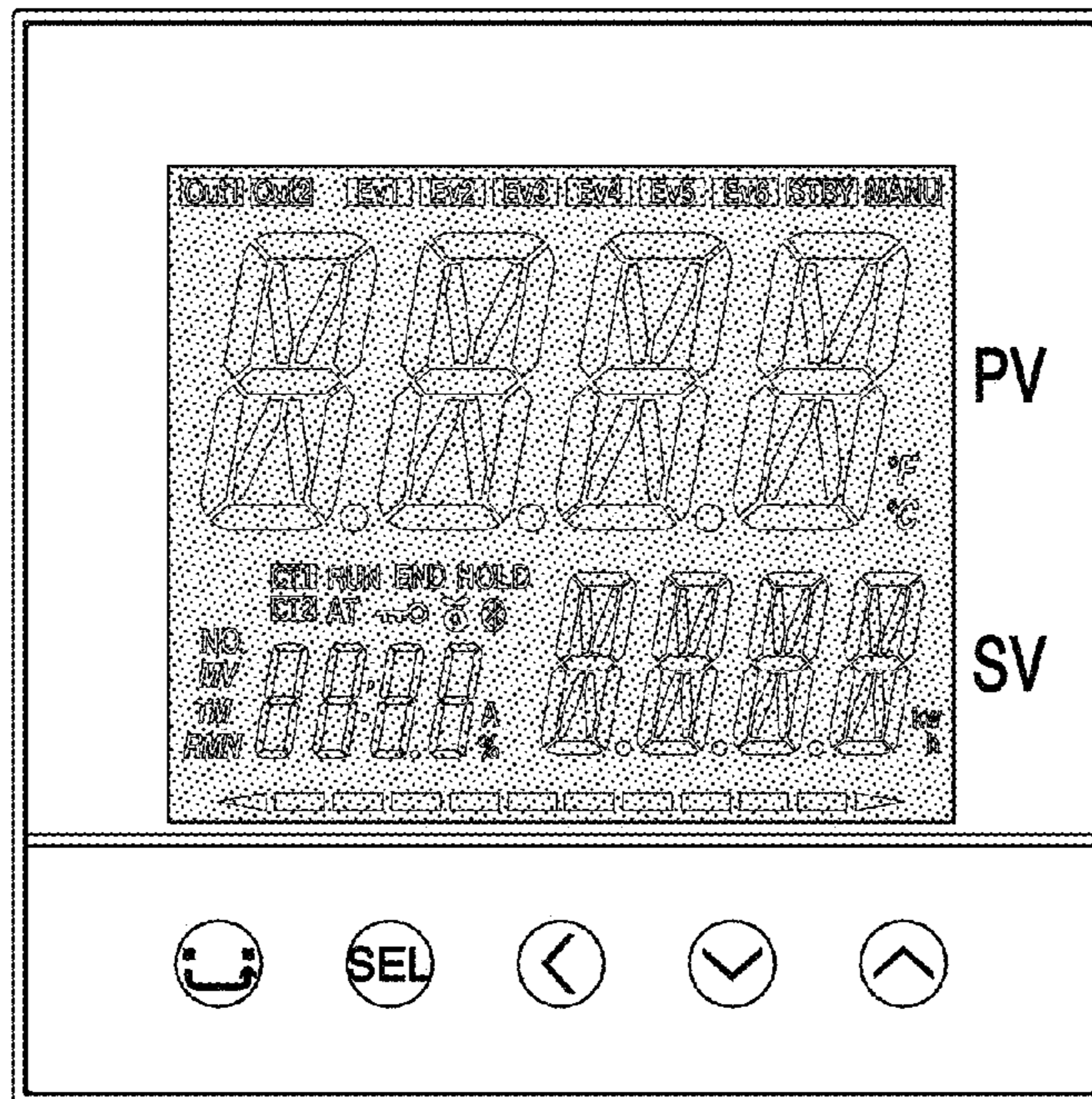

FIG. 10

