



US00D762355S

(12) **United States Design Patent**
Perez

(10) **Patent No.:** **US D762,355 S**
(45) **Date of Patent:** **** Aug. 2, 2016**

(54) **SANDAL**

(71) Applicant: **Edwin Perez**, New Rochelle, NY (US)

(72) Inventor: **Edwin Perez**, New Rochelle, NY (US)

(73) Assignee: **EDKAMI INC.**, New Rochelle, NY (US)

(**) Term: **14 Years**

(21) Appl. No.: **29/480,374**

(22) Filed: **Jan. 24, 2014**

(51) **LOC (10) Cl.** **02-04**

(52) **U.S. Cl.**
USPC **D2/917; D2/899**

(58) **Field of Classification Search**
USPC D02/896, 898, 900, 903, 916-923, 943,
D02/952, 969; 36/45, 11.5, 8.1, 77 M, 77 R,
36/83, 7.5, 7.6

See application file for complete search history.

(56) **References Cited**

U.S. PATENT DOCUMENTS

D224,992 S	10/1972	Iskyan	
D225,188 S	11/1972	Iskyan	
D282,214 S	1/1986	Valori	
D378,009 S *	2/1997	Sullivan et al.	D2/917
D386,587 S *	11/1997	Henson	D2/916
D393,936 S *	5/1998	Henson	D2/899
D393,937 S *	5/1998	Henson	D2/899
D397,541 S *	9/1998	Henson	D2/899
D539,013 S	3/2007	Miller, Jr.	

(Continued)

OTHER PUBLICATIONS

Office Action and Notice of References Cited dated Apr. 2, 2014 from U.S. Appl. No. 29/475,263.

(Continued)

Primary Examiner — Ian Simmons
Assistant Examiner — Rashida C McCoy

(74) *Attorney, Agent, or Firm* — Kheyfits P.C.

(57) **CLAIM**

The ornamental design of a sandal, substantially as shown and described.

DESCRIPTION

FIG. 1 is a perspective view of a first embodiment of a sandal in accordance with the present invention, illustrating the right sandal.

FIG. 2 is a bottom view thereof.

FIG. 3 is a top view thereof;

FIG. 4 is a left view thereof.

FIG. 5 is a right view thereof.

FIG. 6 is a front view thereof.

FIG. 7 is a rear view thereof.

FIG. 8 is perspective view of a second embodiment of a sandal in accordance with the present invention, illustrating the left sandal.

FIG. 9 is a bottom view thereof.

FIG. 10 is a top view thereof;

FIG. 11 is a left view thereof.

FIG. 12 is a right view thereof.

FIG. 13 is a front view thereof.

FIG. 14 is a rear view thereof.

FIG. 15 is a perspective view of a third embodiment of a sandal in accordance with the present invention, illustrating the right sandal.

FIG. 16 is a top view of a left sandal corresponding to the fourth embodiment of the present invention.

FIG. 17 is a top view of a right sandal corresponding to the third embodiment of the present invention.

FIG. 18 is a left view of a left sandal corresponding to the fourth embodiment of the present invention.

FIG. 19 is a right view of a right sandal corresponding to the third embodiment of the present invention.

FIG. 20 is a rear view thereof; and,

FIG. 21 is a rear view of the left sandal corresponding to the fourth embodiment of a sandal in accordance with the present invention.

1 Claim, 12 Drawing Sheets

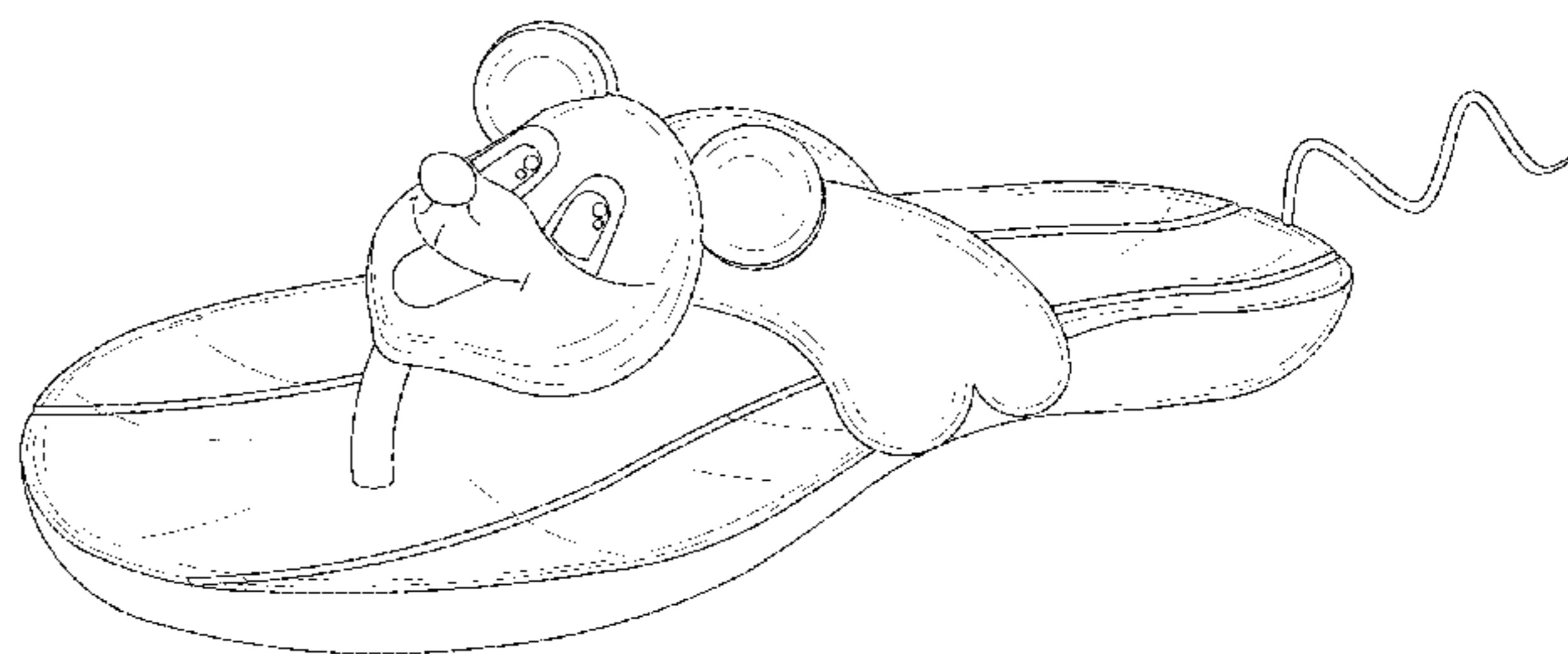
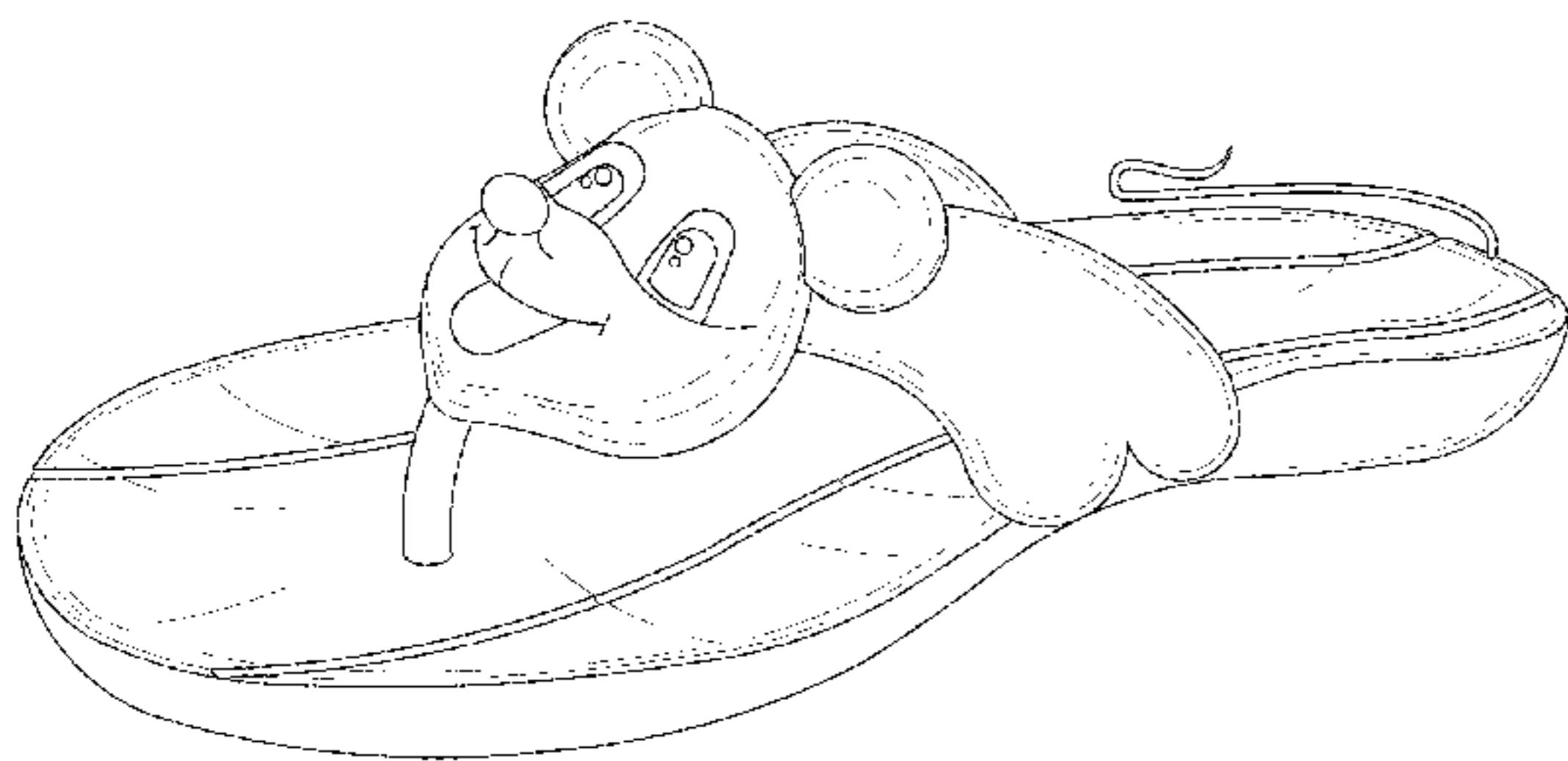

(56)

References Cited

U.S. PATENT DOCUMENTS

D586,984 S	*	2/2009	Schwartz	D2/925
D642,361 S		8/2011	Reaux		
D645,232 S		9/2011	Ratner et al.		
D657,537 S	*	4/2012	Rusnak	D2/899
D677,037 S	*	3/2013	Brunetti	D2/899

OTHER PUBLICATIONS

Office Action and Notice of References Cited dated Mar. 26, 2014 from U.S. Appl. No. 29/475,276.

Response to Office Action dated Mar. 26, 2014 from U.S. Appl. No. 29/475,276.

Office Action and Notice of References Cited dated Mar. 27, 2014 from U.S. Appl. No. 29/480,354.

Printout of Insoles, Inserts & Orthotics Products and Brands from Dr. Scholl's website dated Mar. 17, 2014 (http://www.drscholls.com/Products/IIO_index).

Printout of Stock Photo: Cute mouse cartoon from Shutterstock.com (2013).

Design U.S. Appl. No. 29/475,263, titled Sandal, filed by inventor Edwin Perez on Dec. 2, 2013.

Design U.S. Appl. No. 29/475,276, titled Sandal, filed by inventor Edwin Perez on Dec. 2, 2013.

Design U.S. Appl. No. 29/480,354, titled Sandal, filed by inventor Edwin Perez on Jan. 24, 2014.

U.S. Appl. No. 13/668,195, titled Enhanced Figure Footwear, filed by inventor Edwin Perez on Nov. 2, 2012.

U.S. Appl. No. 14/102,875, titled Enhanced Footwear, filed by inventor Edwin Perez on Dec. 11, 2013.

* cited by examiner

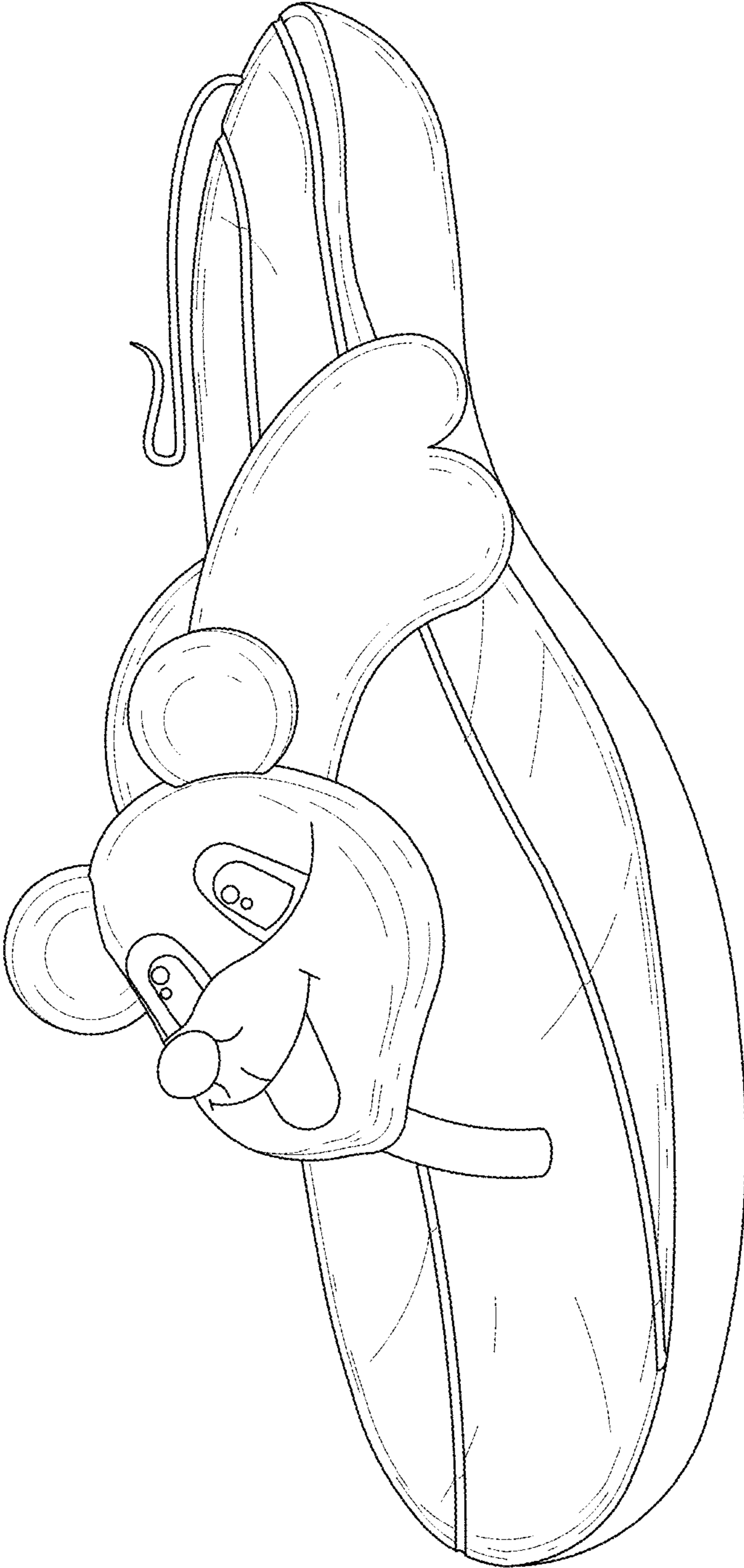

FIG. 1

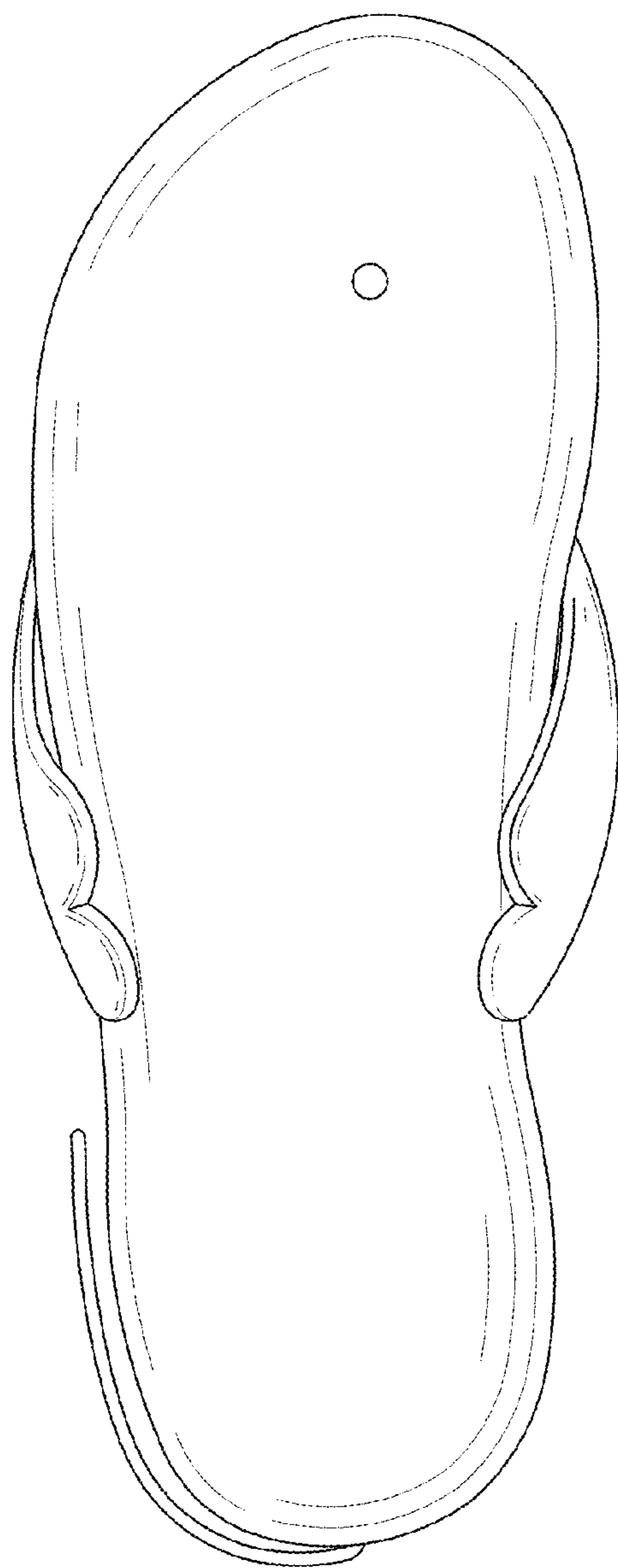

FIG. 2

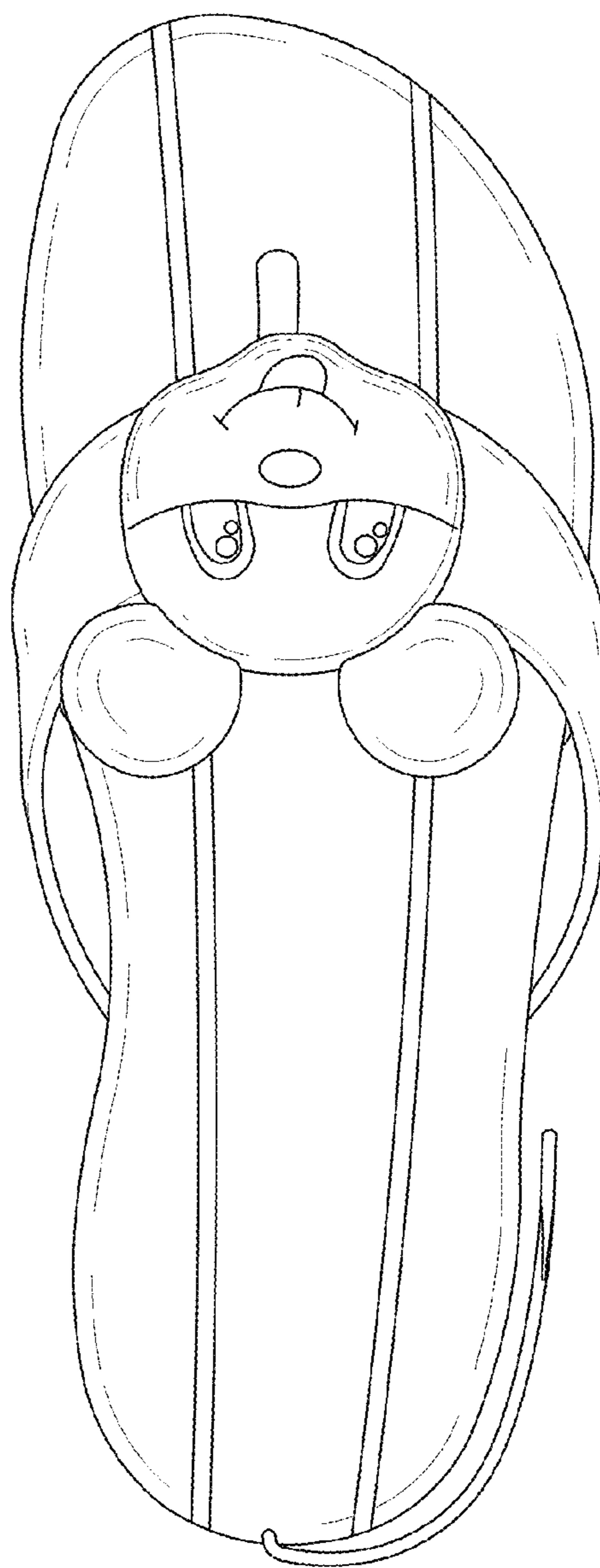

FIG. 3

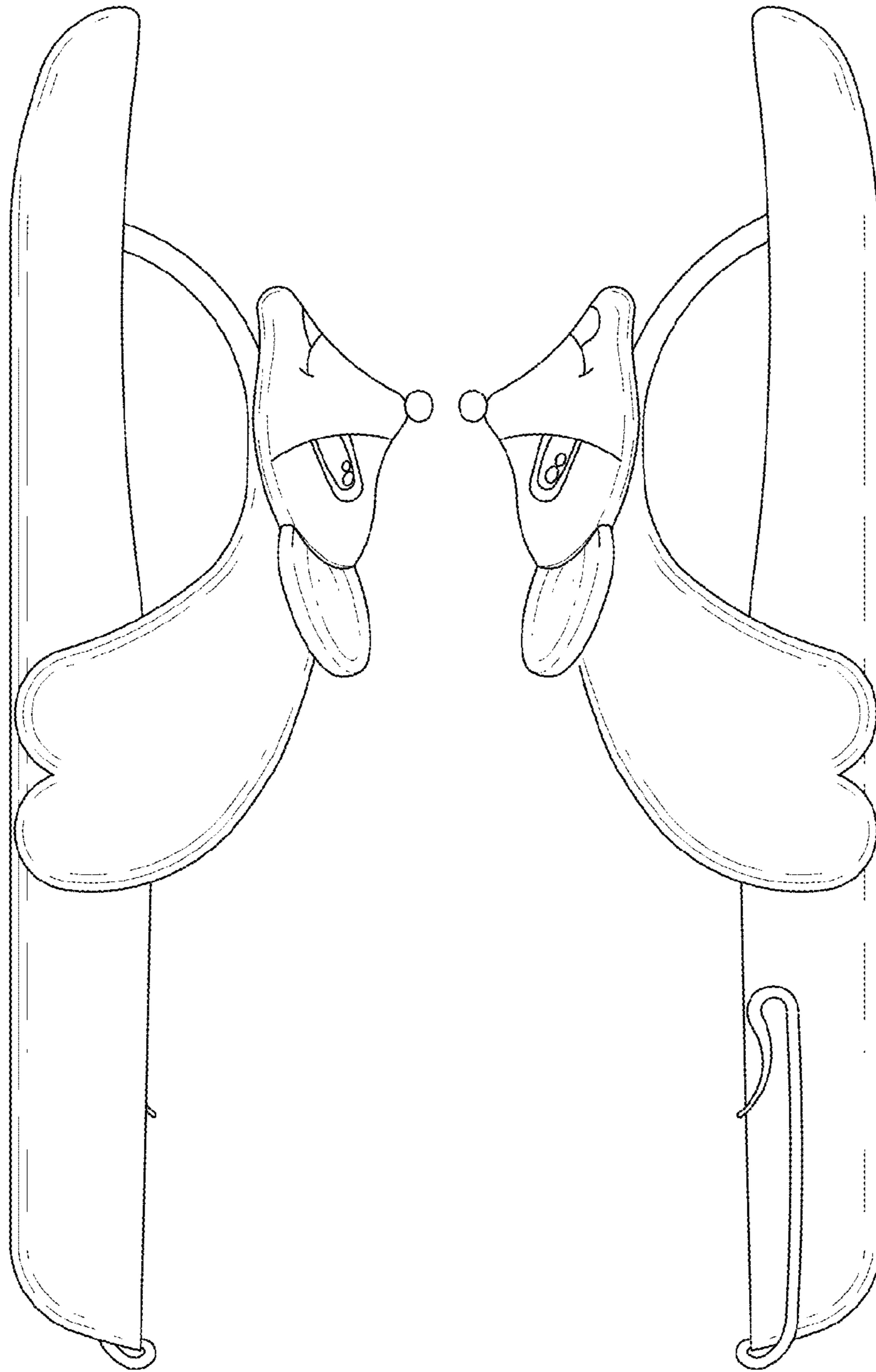

FIG. 4

FIG. 5

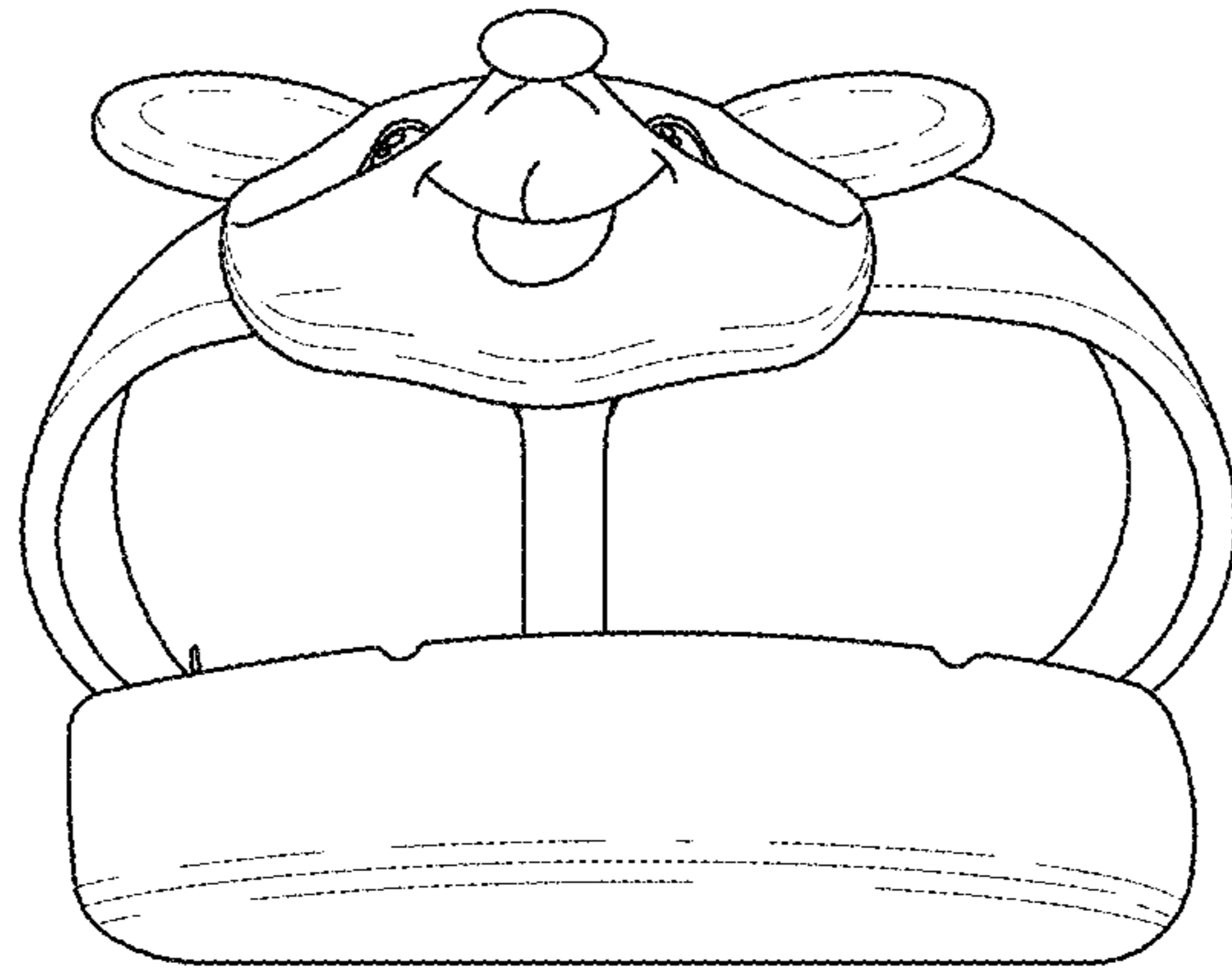

FIG. 6

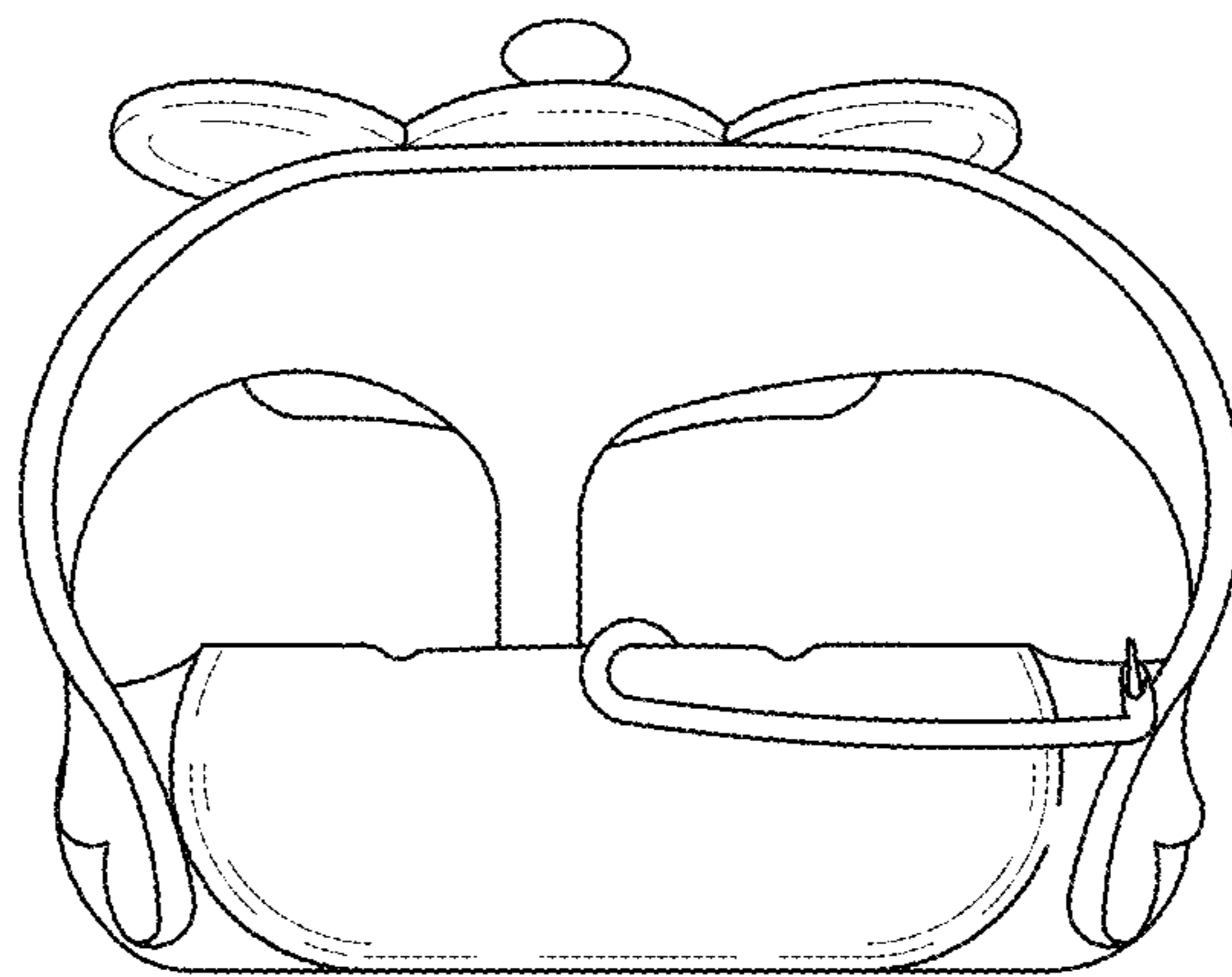

FIG. 7

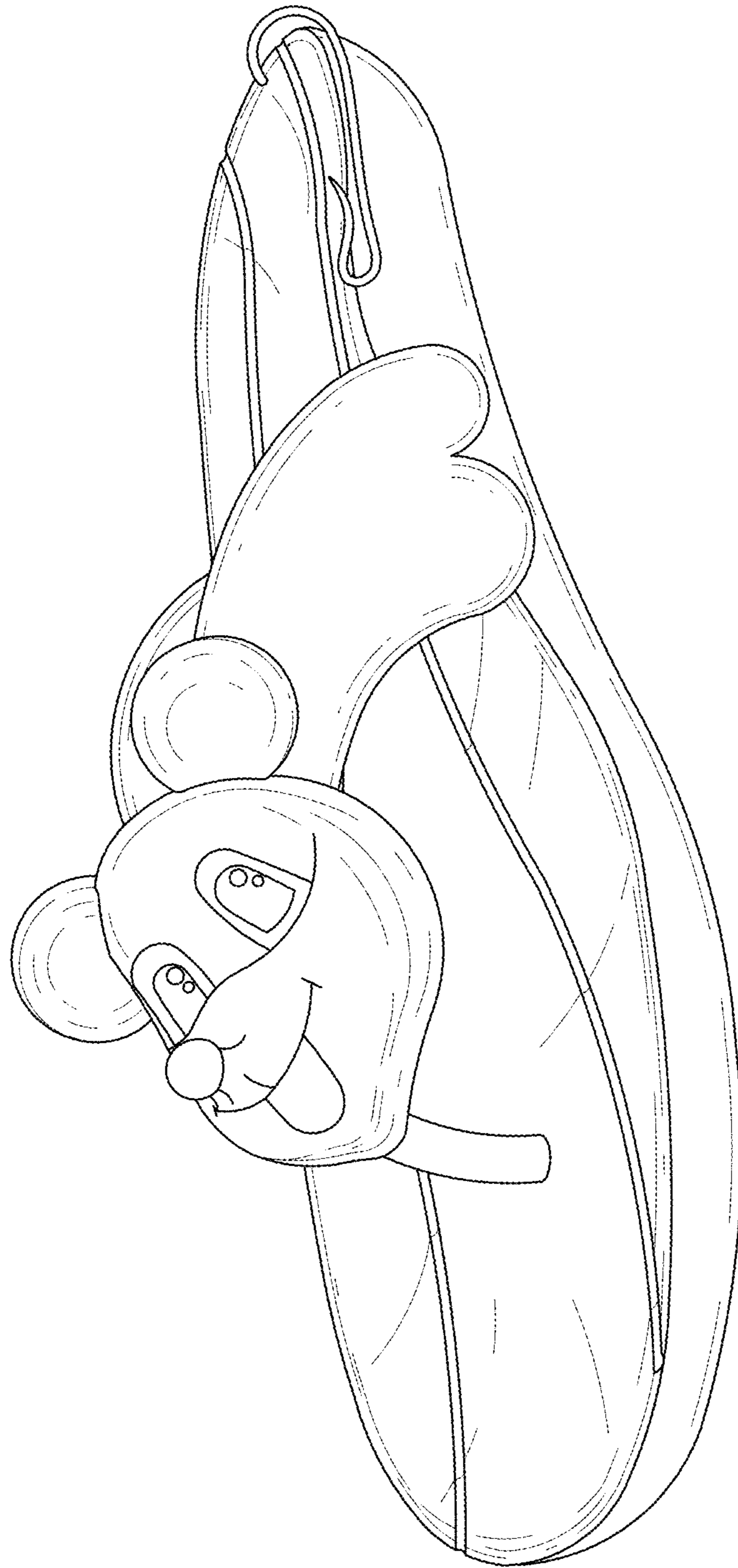

FIG. 8

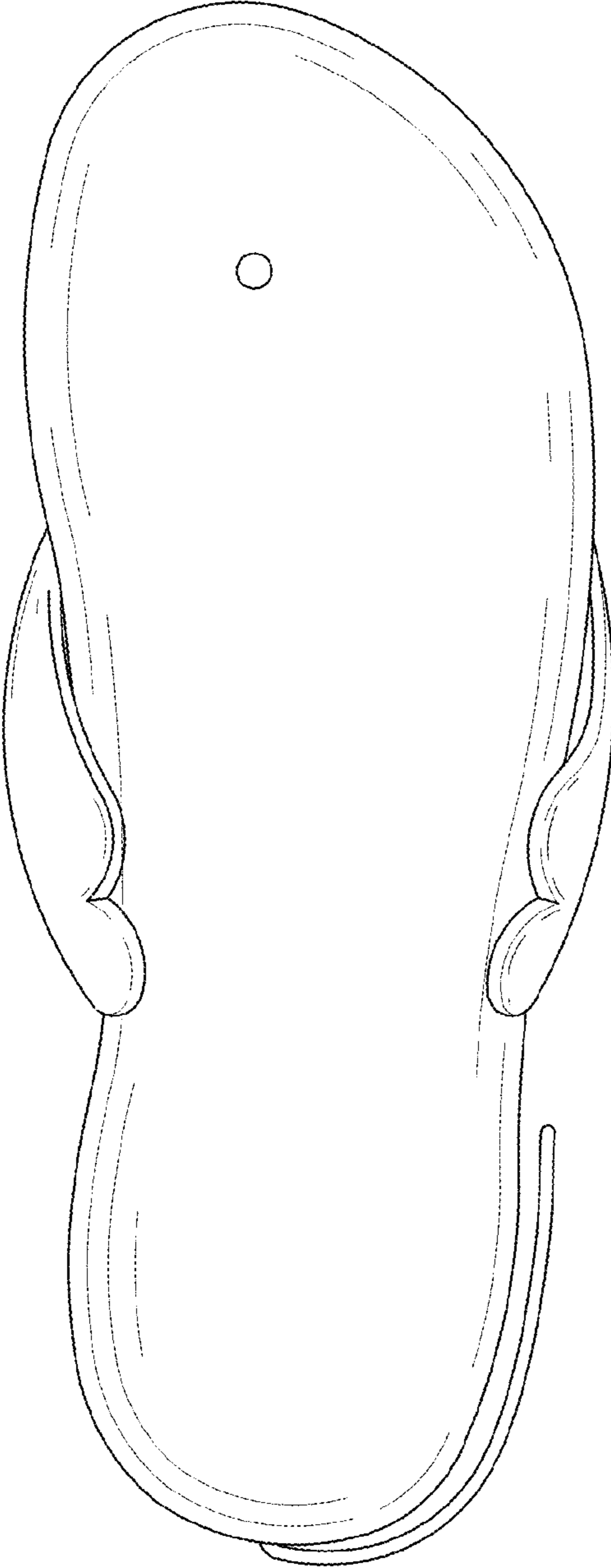

FIG. 9

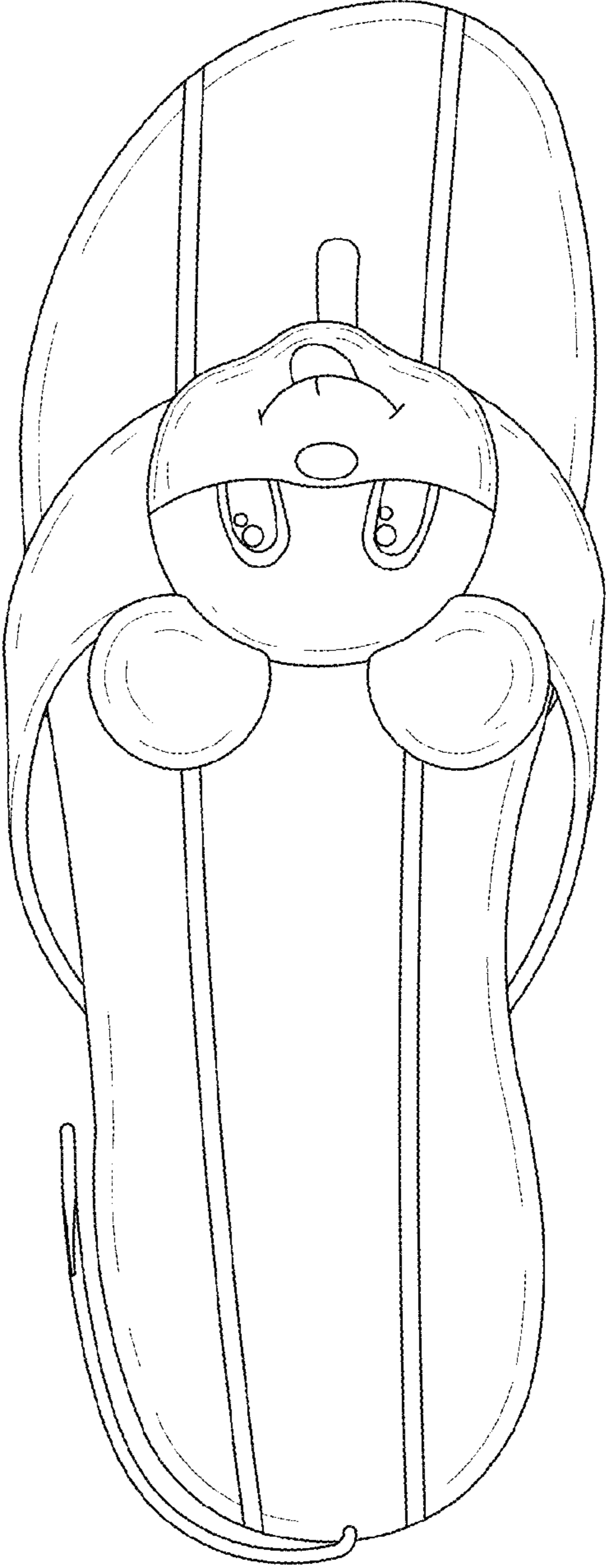

FIG. 10

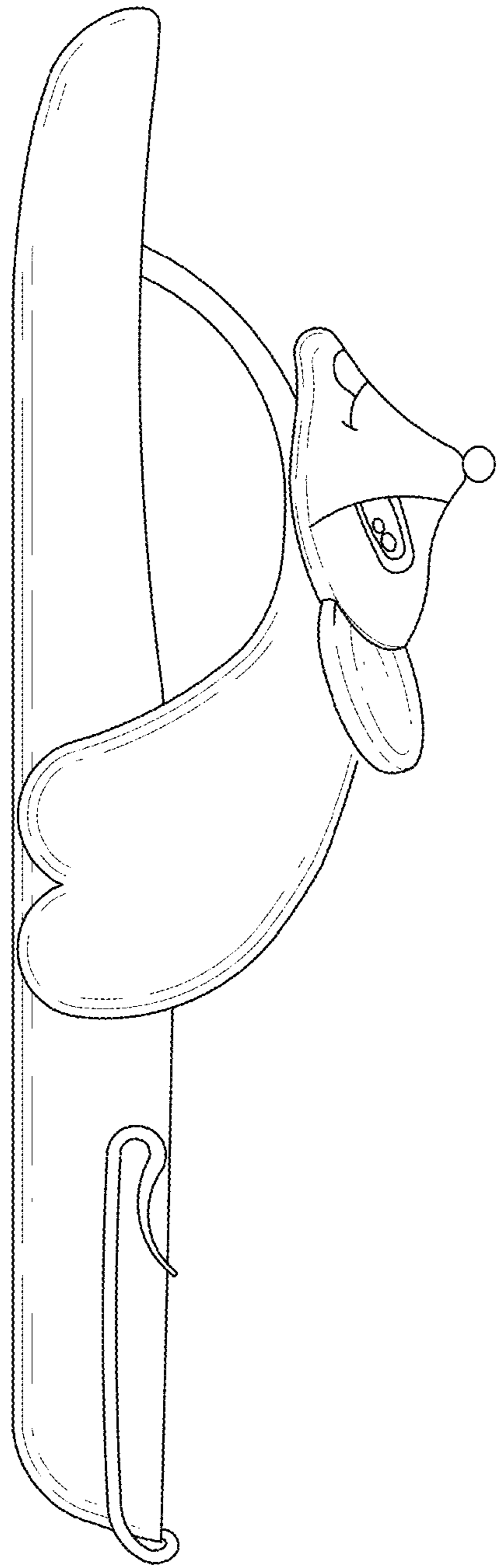

FIG. 11

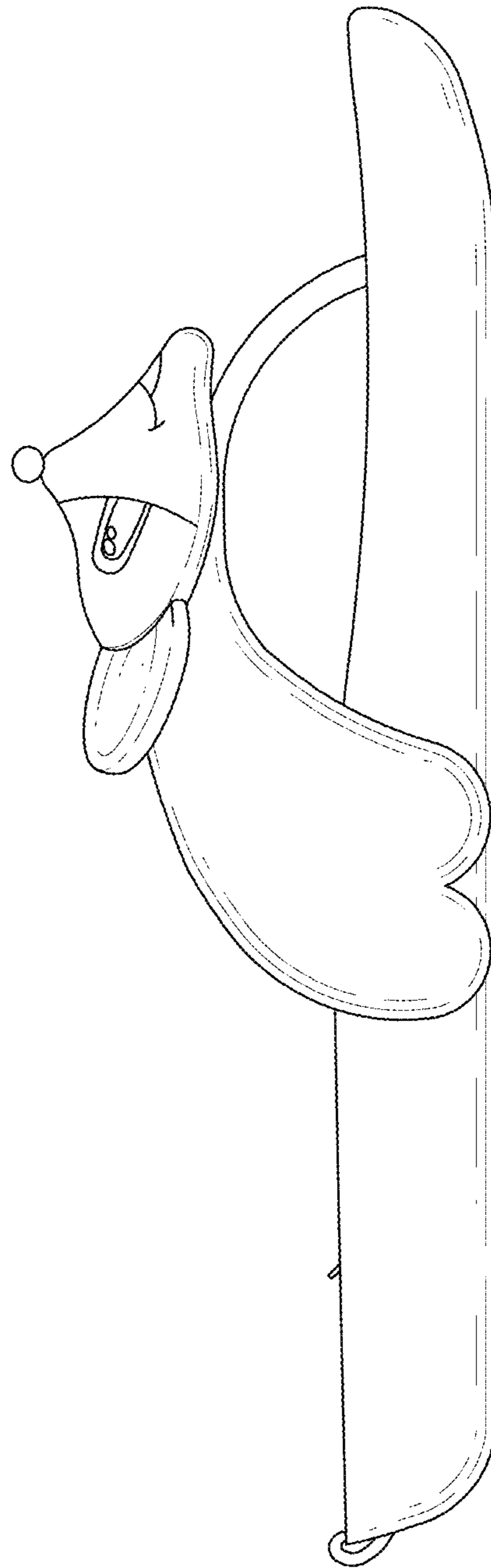

FIG. 12

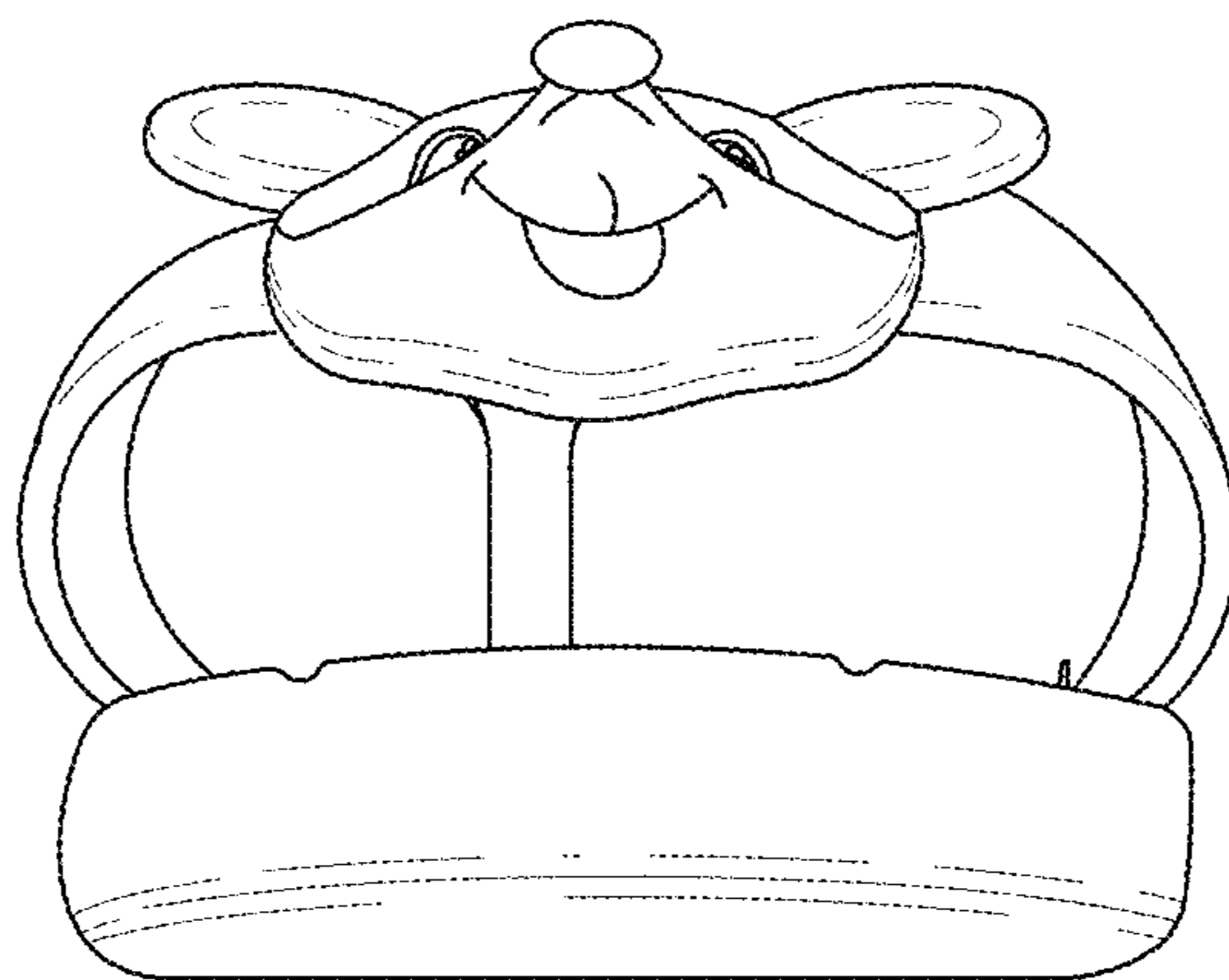

FIG. 13

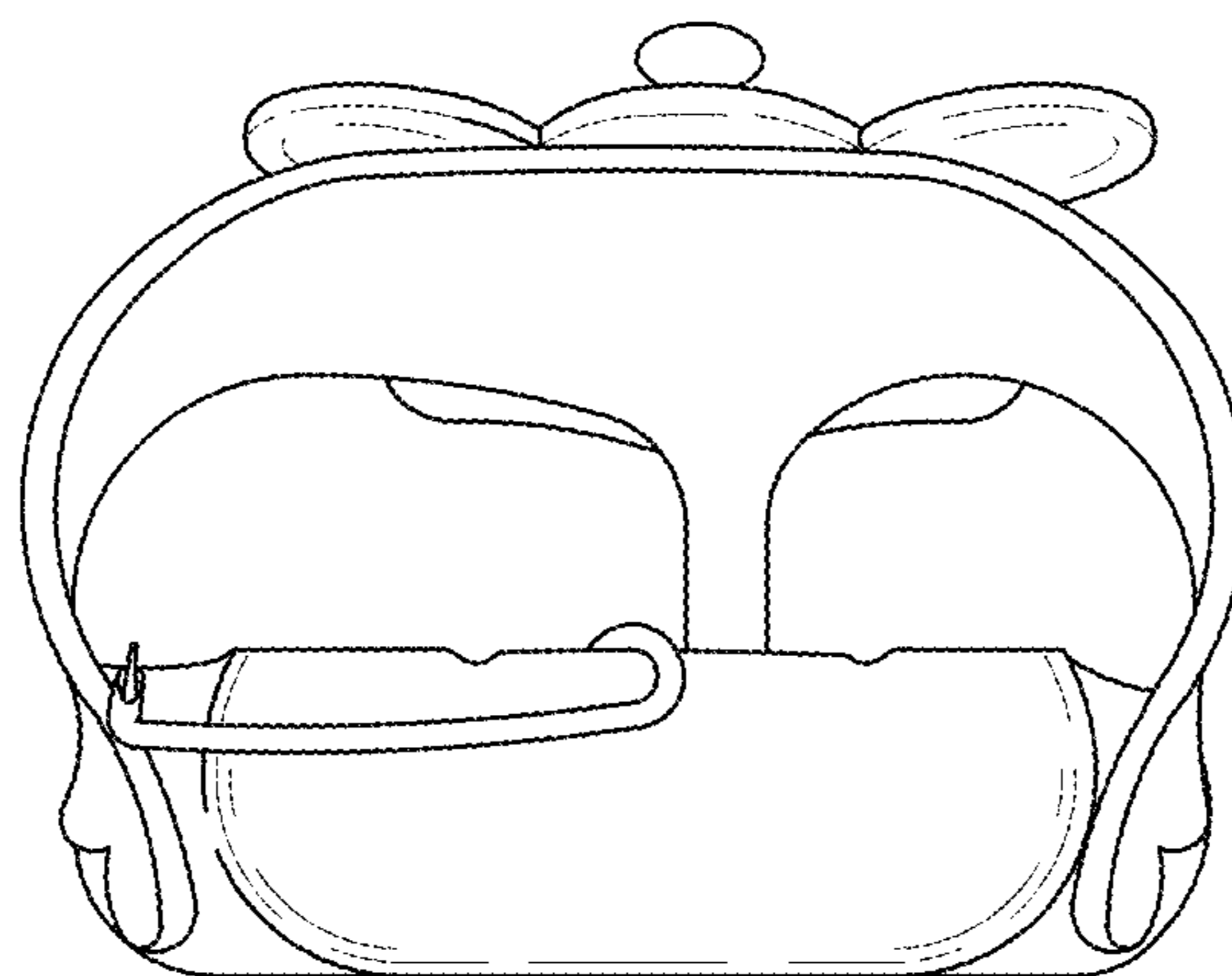

FIG. 14

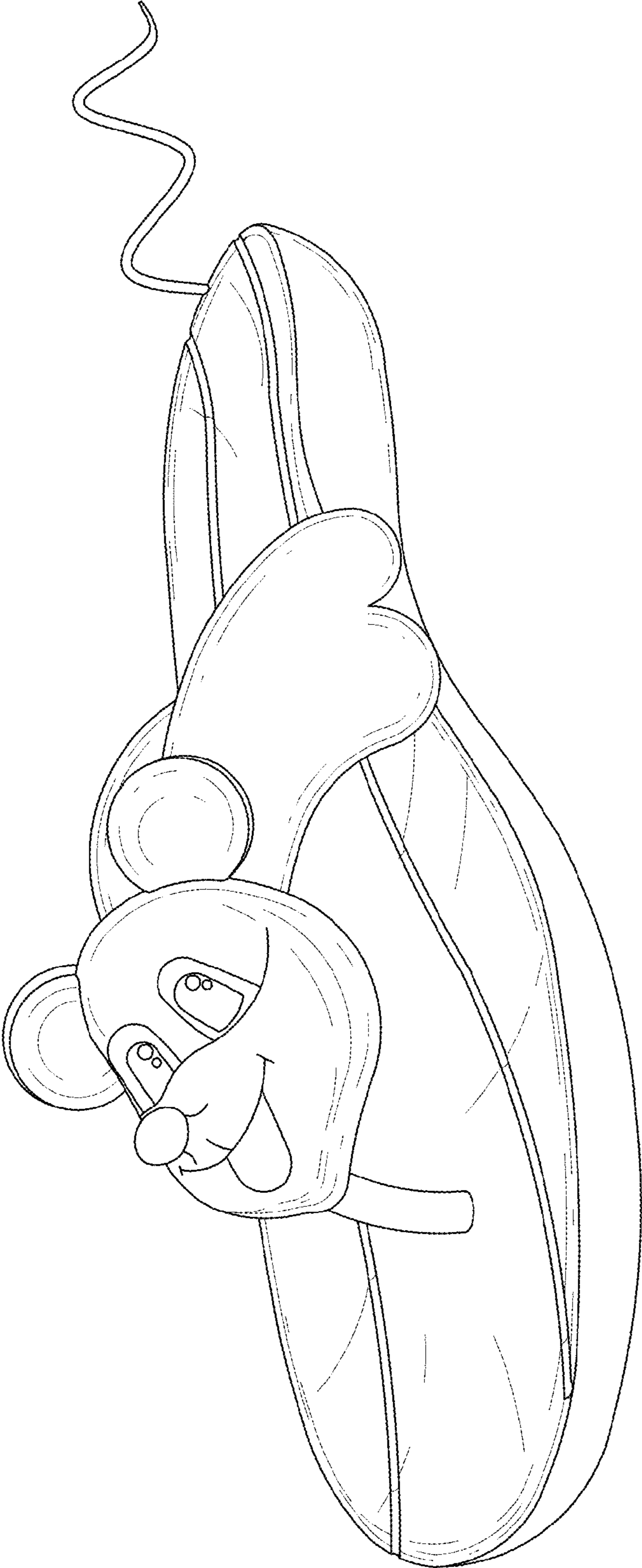

FIG. 15

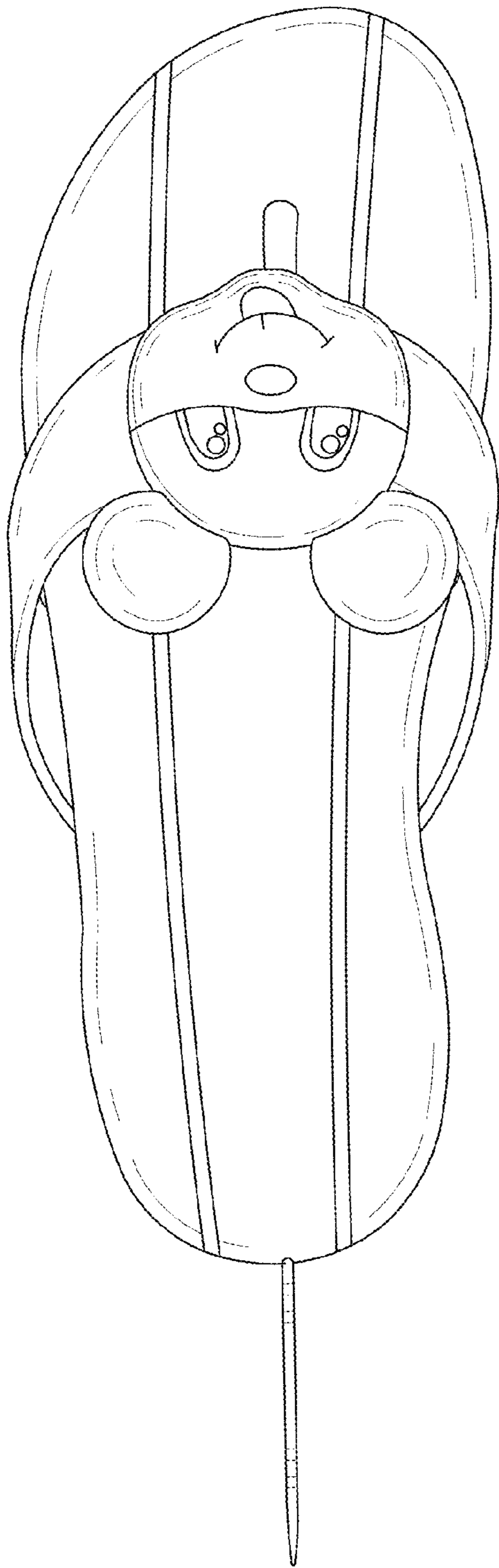

FIG. 16

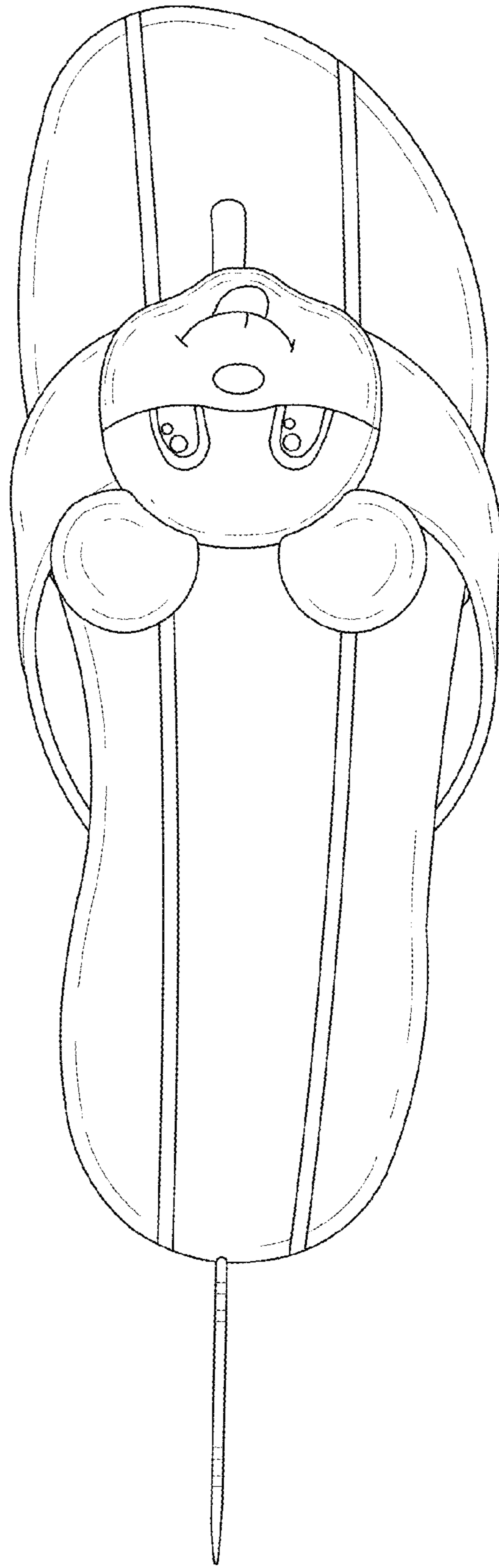

FIG. 17

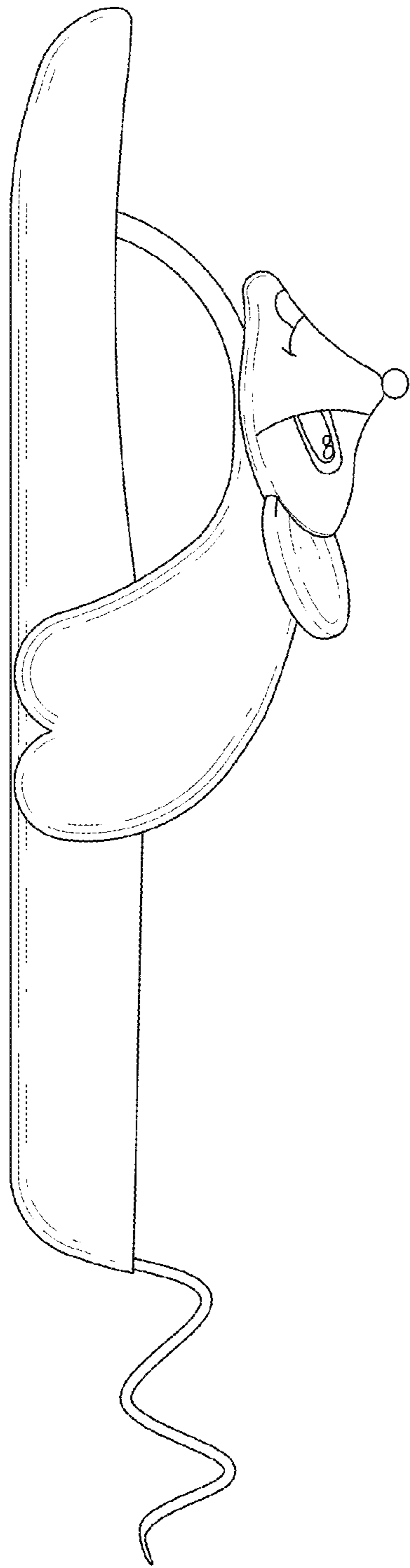

FIG. 18

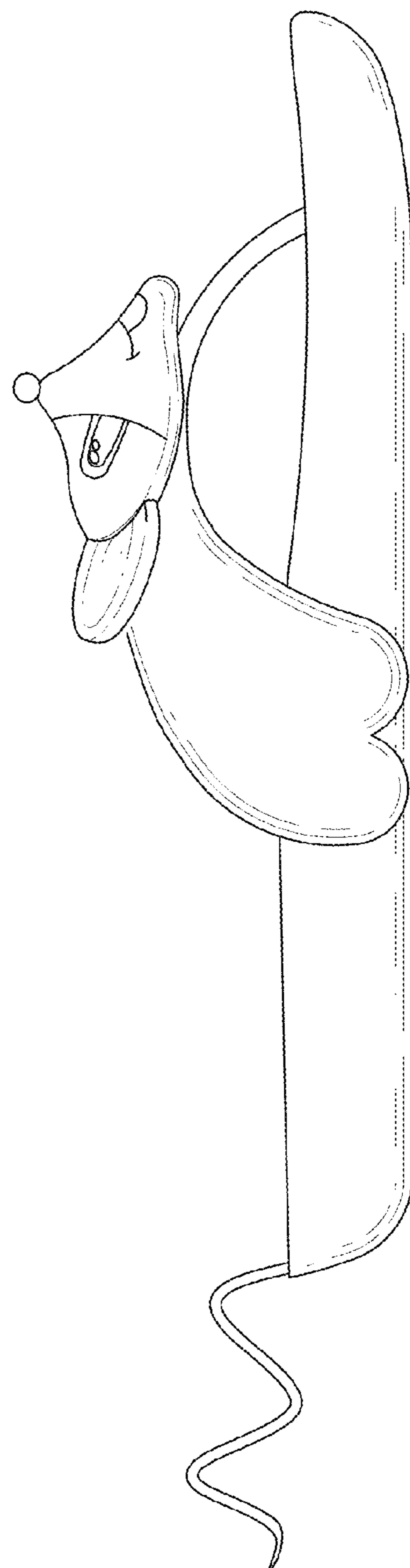

FIG. 19

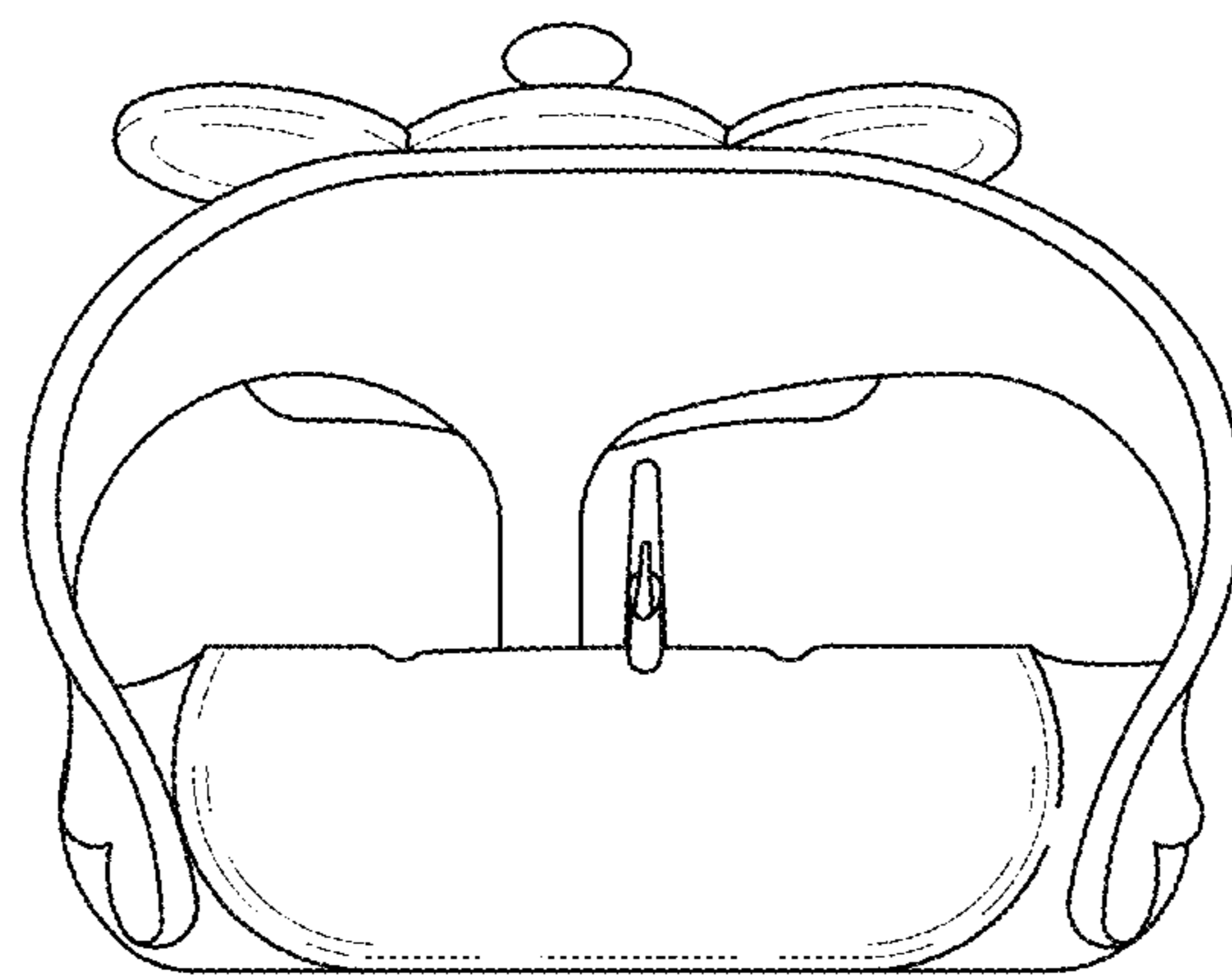

FIG. 20

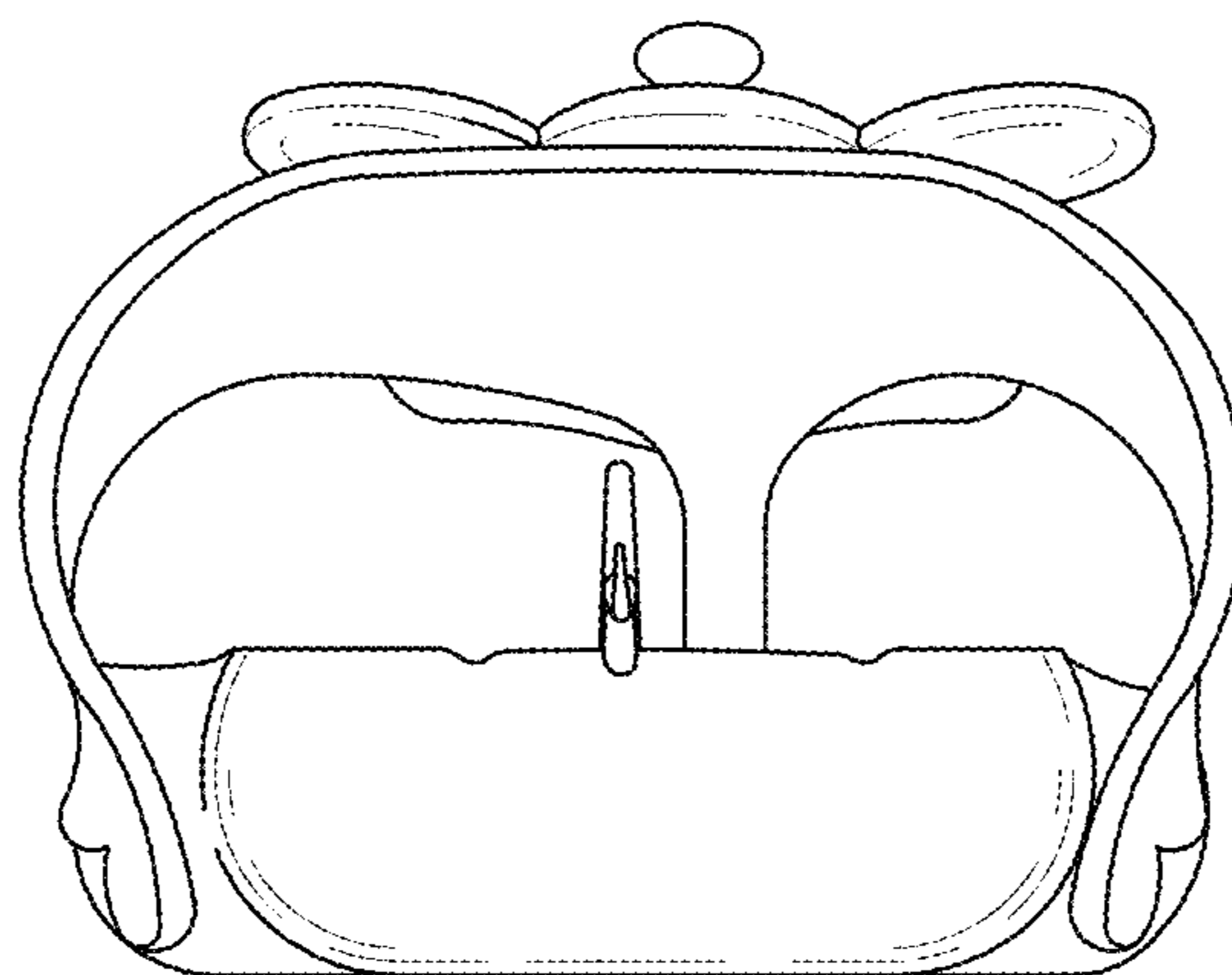

FIG. 21