



US00D762315S

(12) **United States Design Patent**
Lin

(10) **Patent No.:** **US D762,315 S**
(45) **Date of Patent:** **** Jul. 26, 2016**

(54) **LAMP**

DESCRIPTION

(71) Applicant: **Po-Heng Lin**, New Taipei (TW)
(72) Inventor: **Po-Heng Lin**, New Taipei (TW)
(**) Term: **14 Years**
(21) Appl. No.: **29/513,099**
(22) Filed: **Dec. 26, 2014**
(51) **LOC (10) Cl.** **26-06**
(52) **U.S. Cl.**
USPC **D26/31**
(58) **Field of Classification Search**
USPC D26/28–36; 362/61, 80–83, 267–269,
362/459–468, 475–478, 485–487
CPC F21S 48/00; F21S 48/10; F21S 48/115;
F21S 48/225; F21S 48/1233; F21S 48/1266;
F21S 48/1388; F21S 48/2268; F21V 21/04
See application file for complete search history.

(56) **References Cited**

U.S. PATENT DOCUMENTS

D499,198 S * 11/2004 Cowan D26/31
D564,683 S * 3/2008 Roach D26/28
D656,258 S * 3/2012 Georgitsis D26/31
D676,990 S * 2/2013 Adams D26/31

* cited by examiner

Primary Examiner — Marcus Jackson

(74) *Attorney, Agent, or Firm* — C. G. Mersereau; Nikolai & Mersereau, P.A.

(57) **CLAIM**

The ornamental design for a lamp, as shown and described.

FIG. 1 is a perspective view of a lamp, showing my new design, wherein the broken lines are shown for illustrative purposes only and form no part of the claimed design;
FIG. 2 is a front view thereof, wherein the broken lines are shown for illustrative purposes only and form no part of the claimed design;
FIG. 3 is a rear view thereof;
FIG. 4 is a left side view thereof;
FIG. 5 is a right side view thereof;
FIG. 6 is a top view thereof;
FIG. 7 is a bottom view thereof;
FIG. 8 is another perspective view thereof;
FIG. 9 is a referential perspective view of a first embodiment of the claimed design, wherein the broken lines are shown for illustrative purposes only and form no part of the claimed design;
FIG. 10 is a referential perspective view of a second embodiment of the claimed design, wherein the broken lines are shown for illustrative purposes only and form no part of the claimed design;
FIG. 11 is a referential perspective view of a third embodiment of the claimed design, wherein the broken lines are shown for illustrative purposes only and form no part of the claimed design;
FIG. 12 is a referential perspective view of a fourth embodiment of the claimed design, wherein the broken lines are shown for illustrative purposes only and form no part of the claimed design; and,
FIG. 13 is a referential perspective view of a fifth embodiment of the claimed design, wherein the broken lines are shown for illustrative purposes only and form no part of the claimed design.

1 Claim, 10 Drawing Sheets

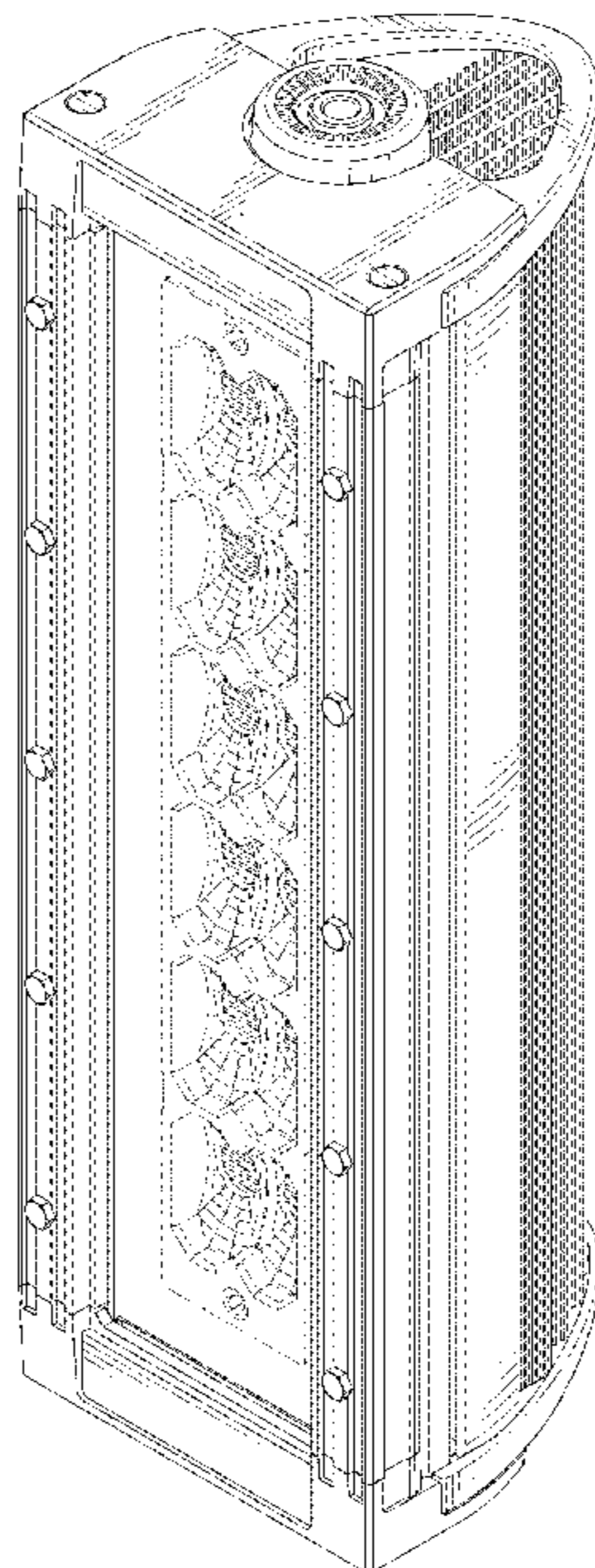

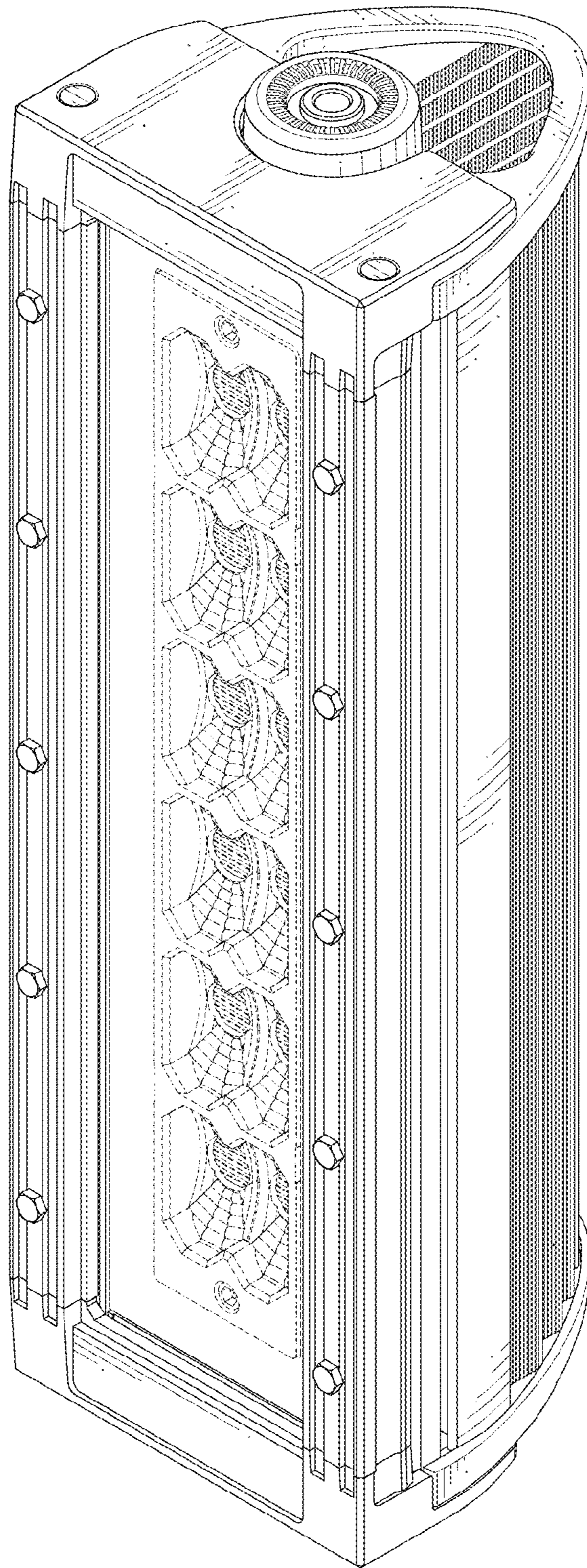

FIG. 1

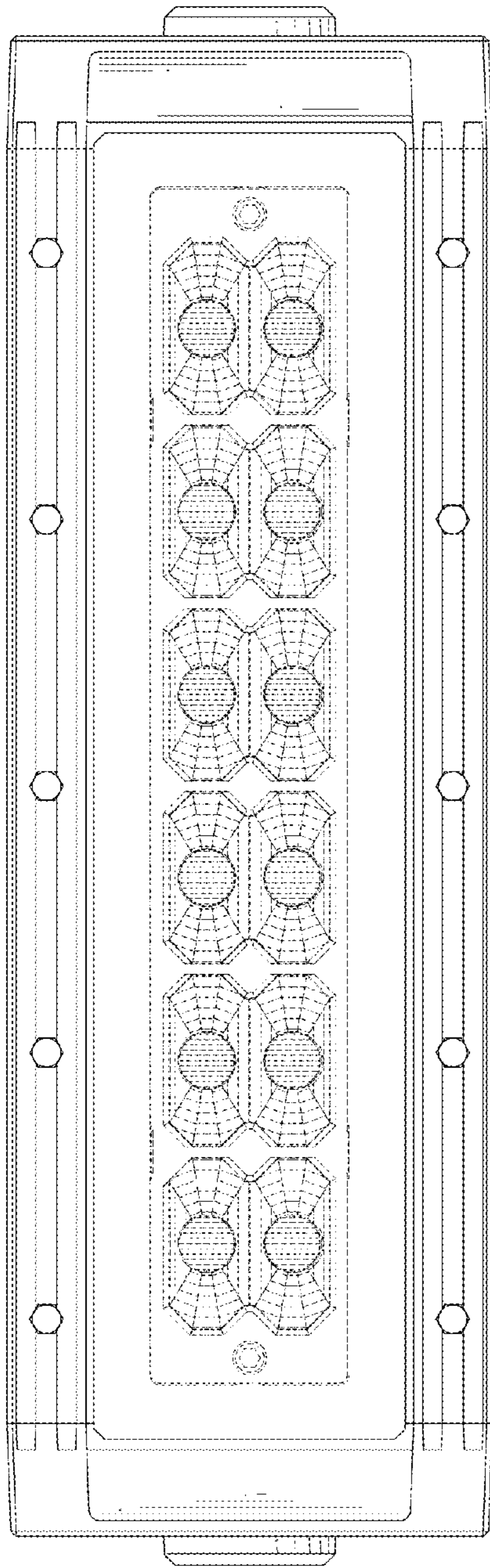

FIG. 2

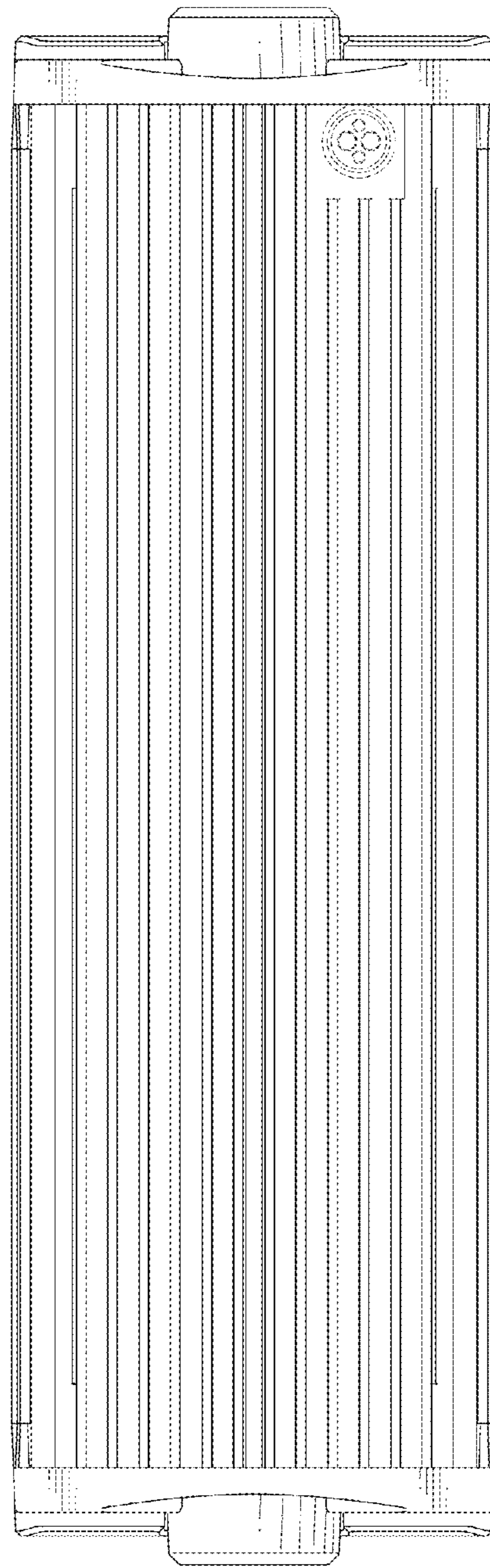

FIG. 3

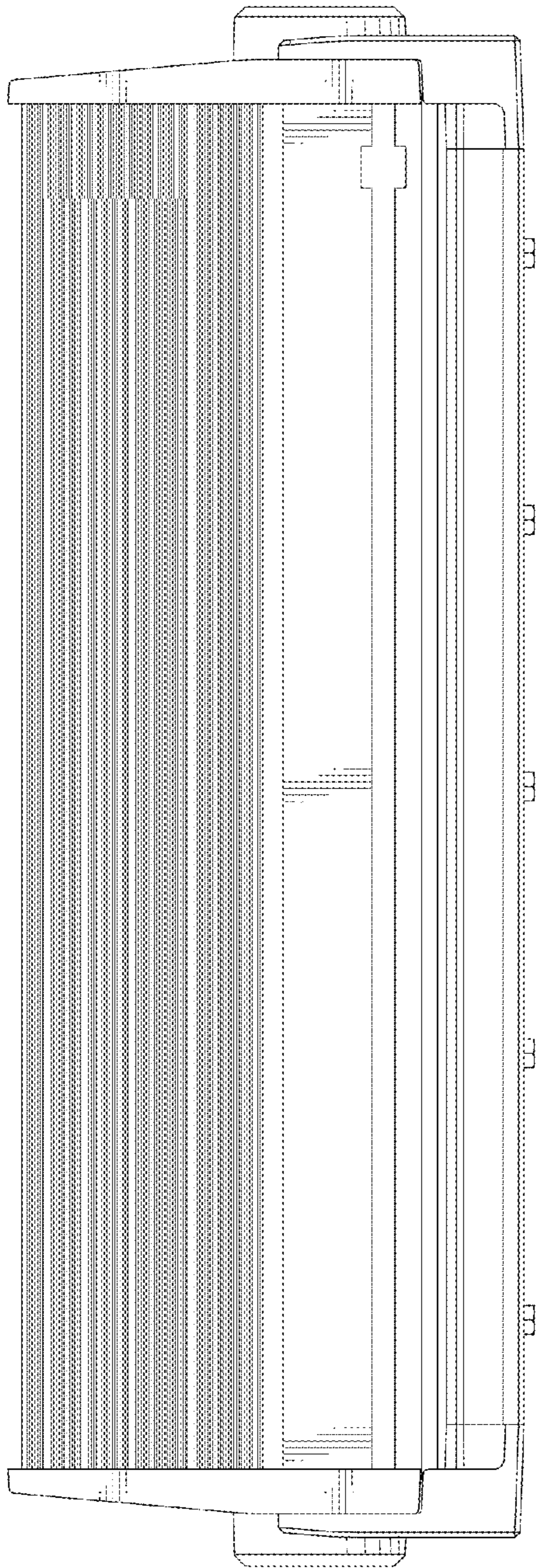

FIG. 4

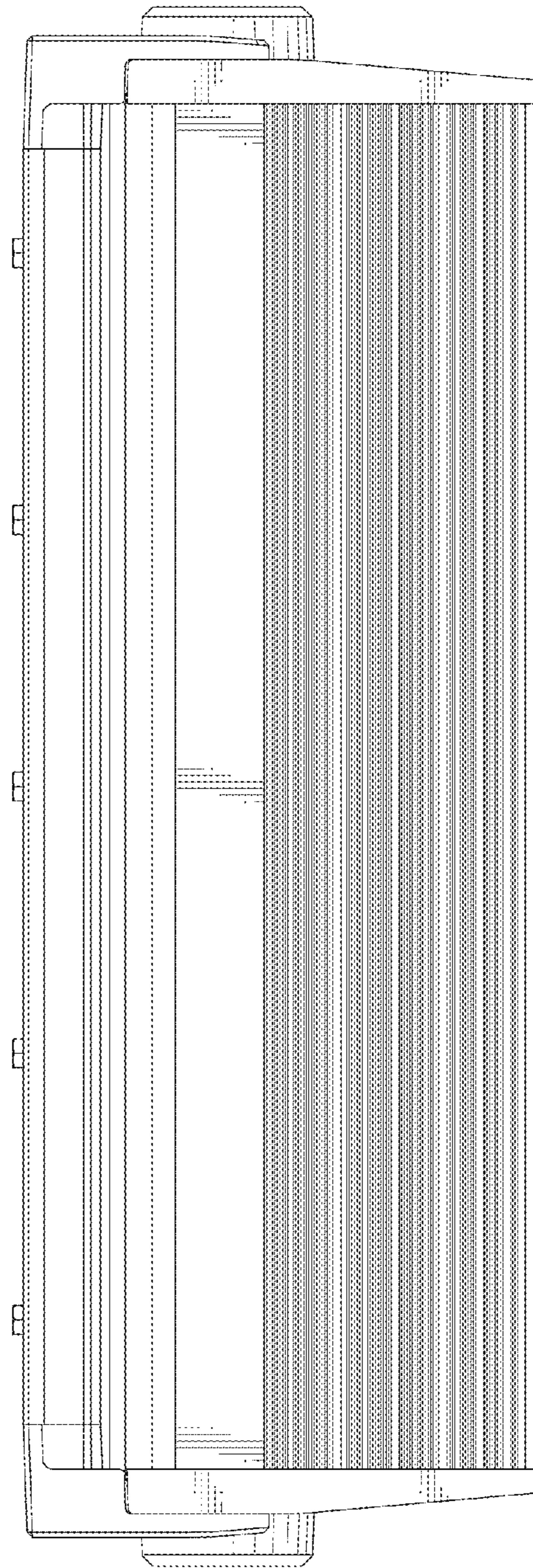

FIG. 5

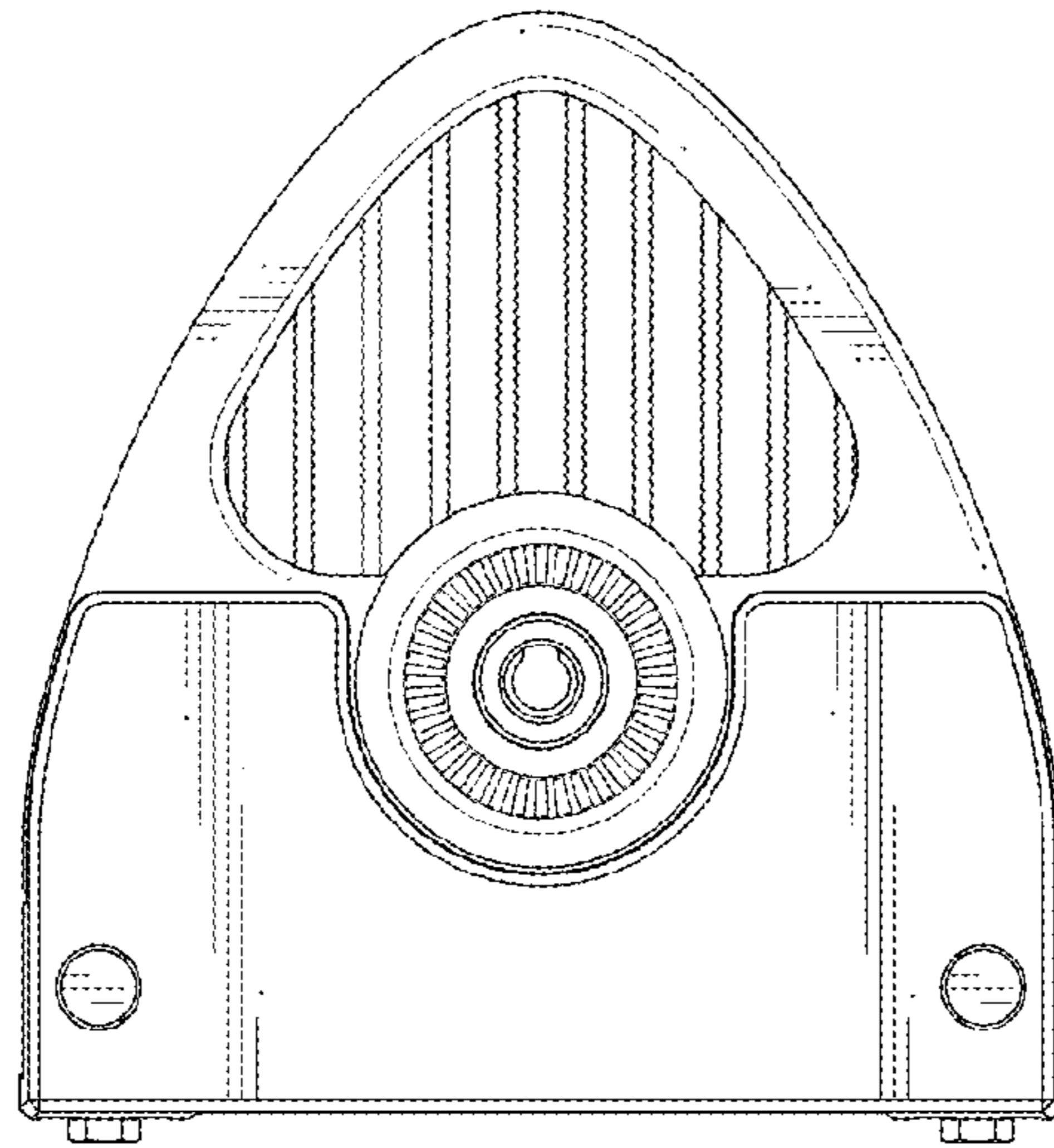

FIG. 6

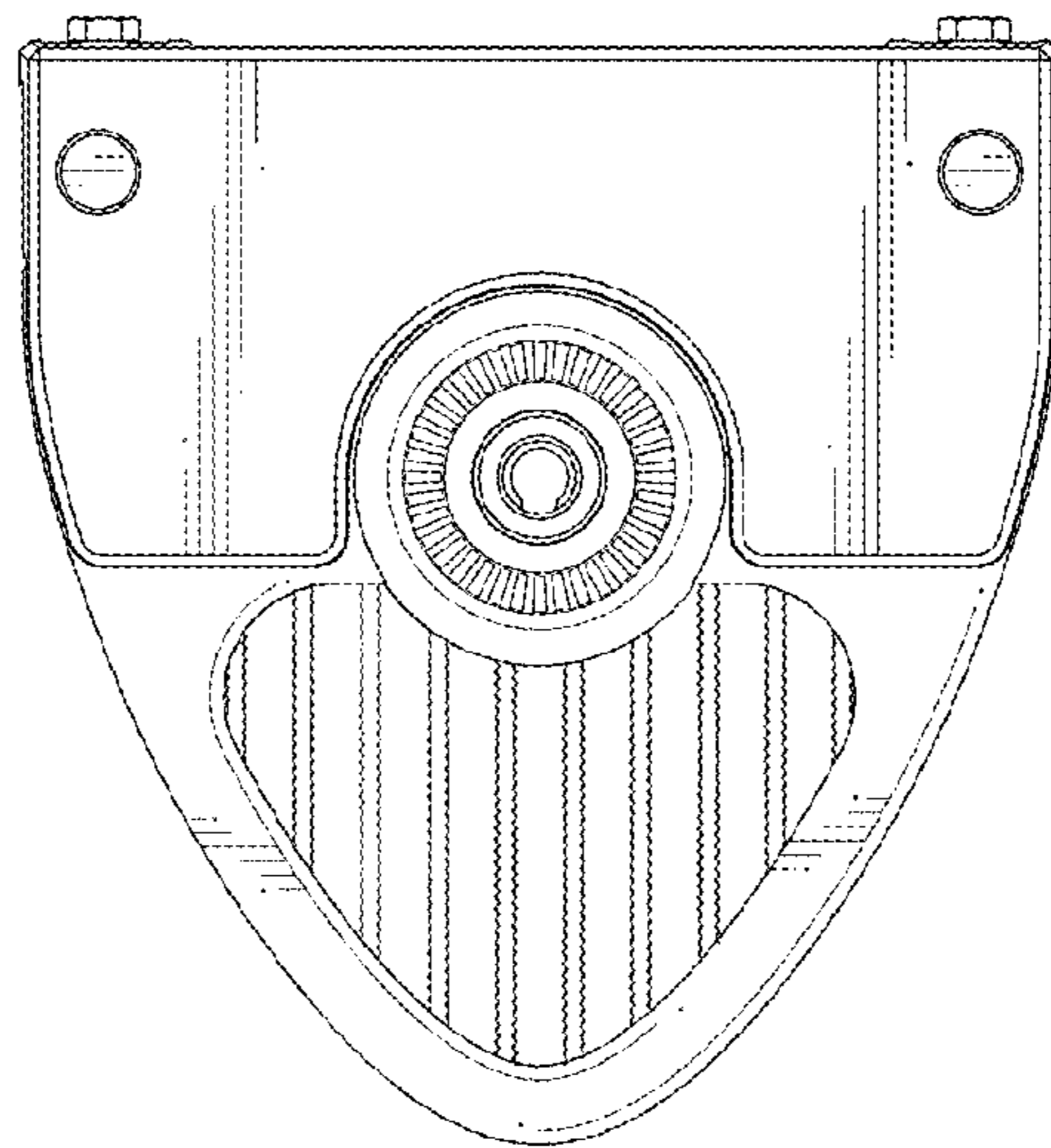

FIG. 7

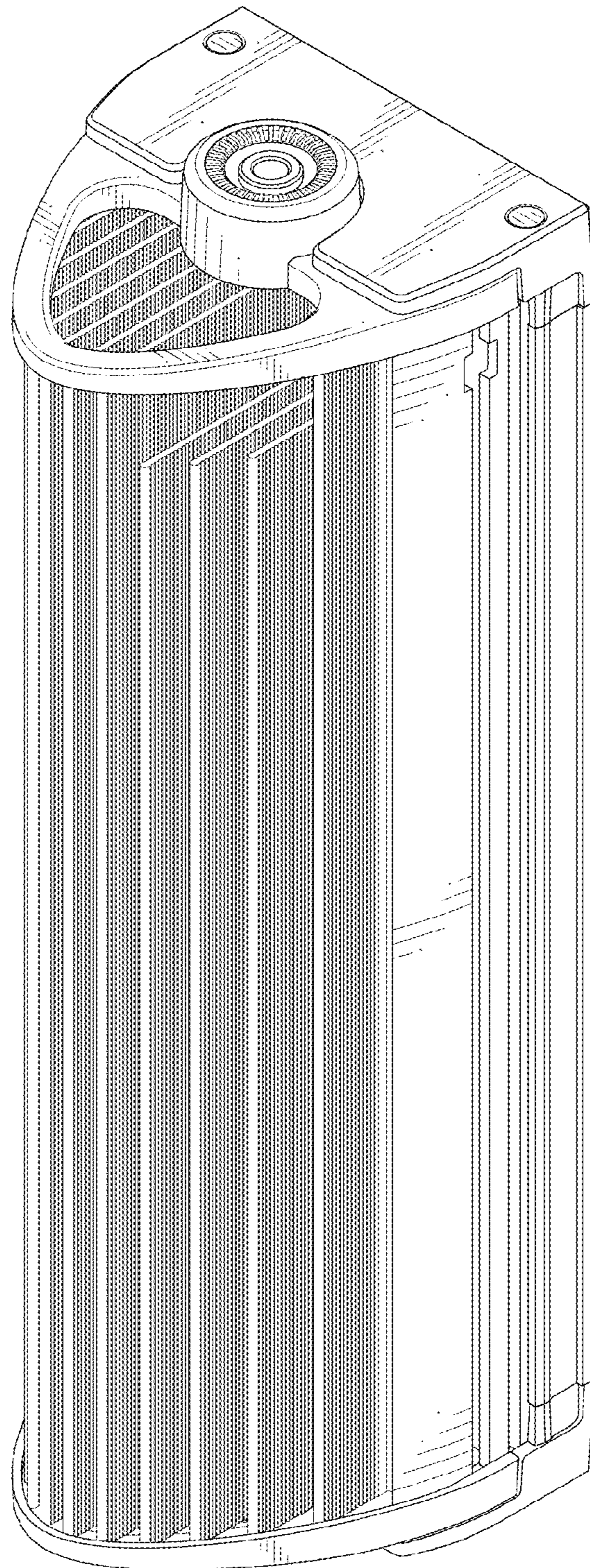

FIG. 8

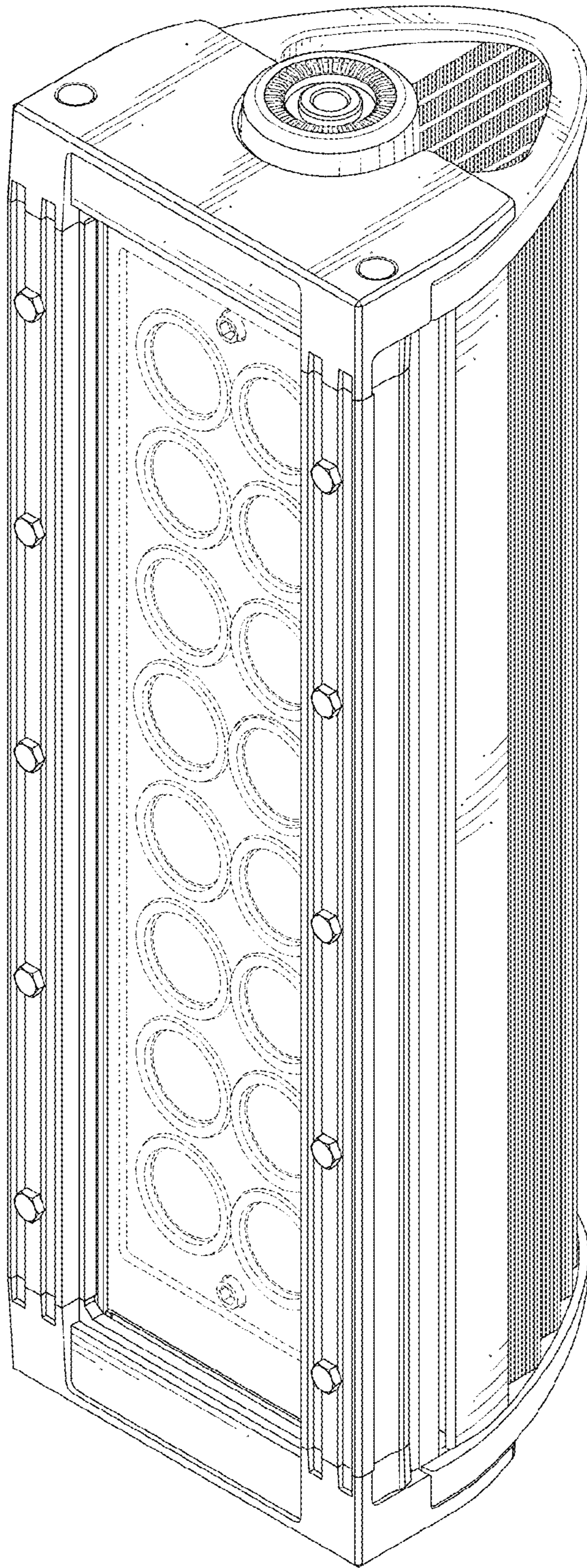

FIG. 9

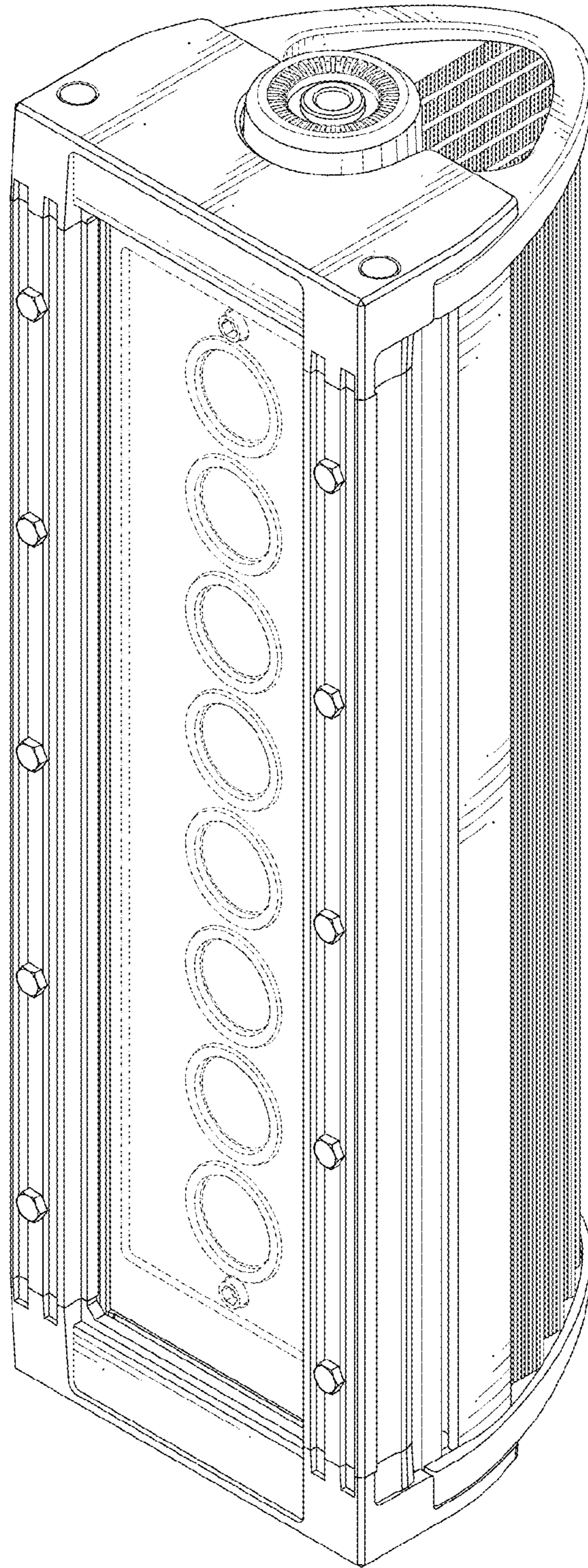

FIG. 10

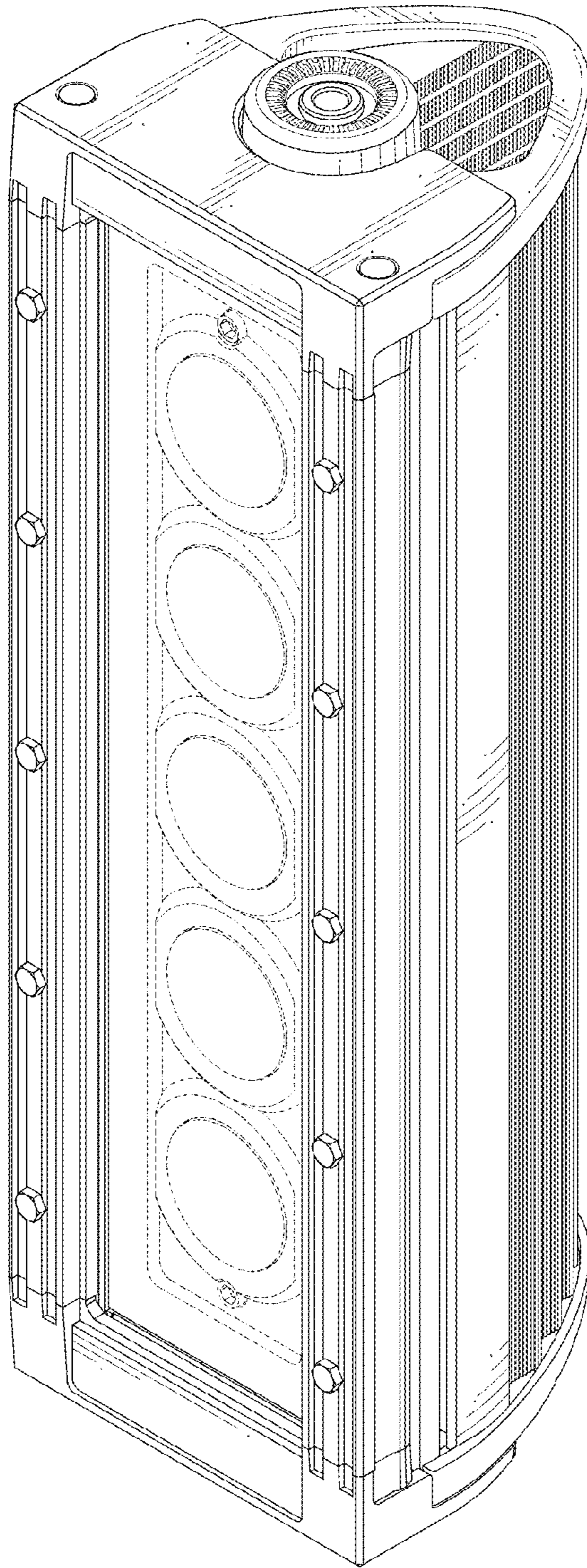

FIG. 11

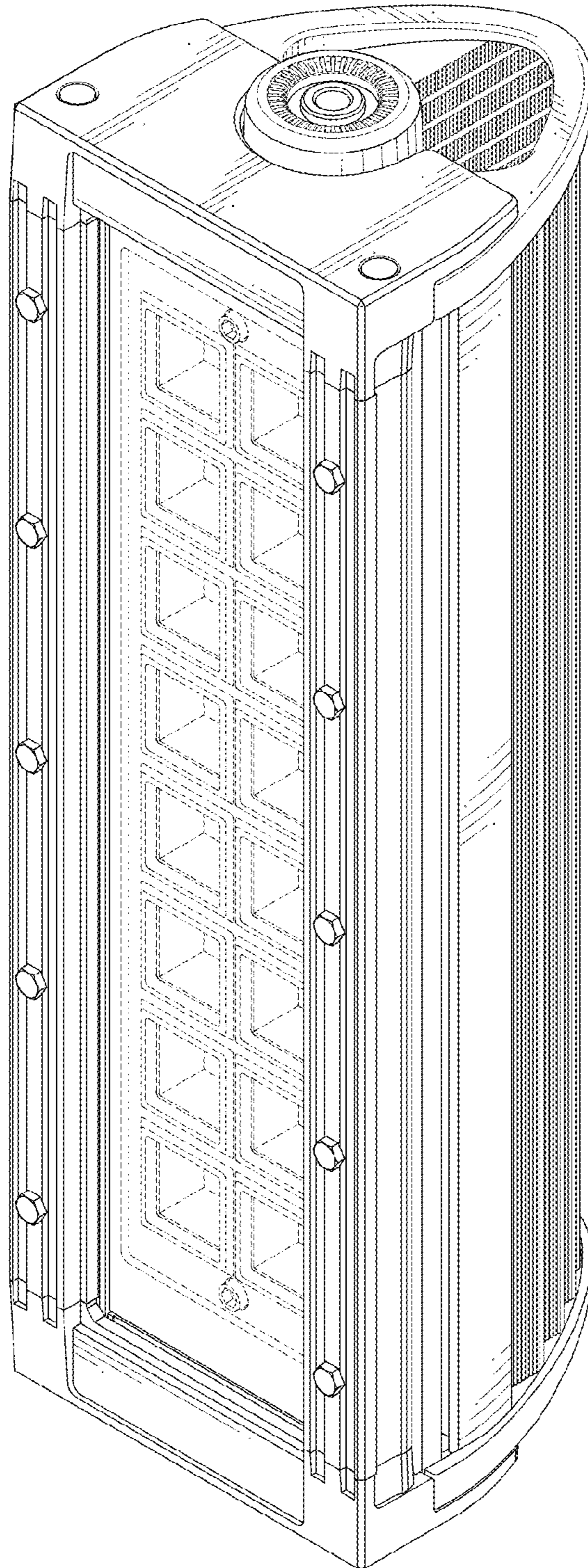

FIG. 12

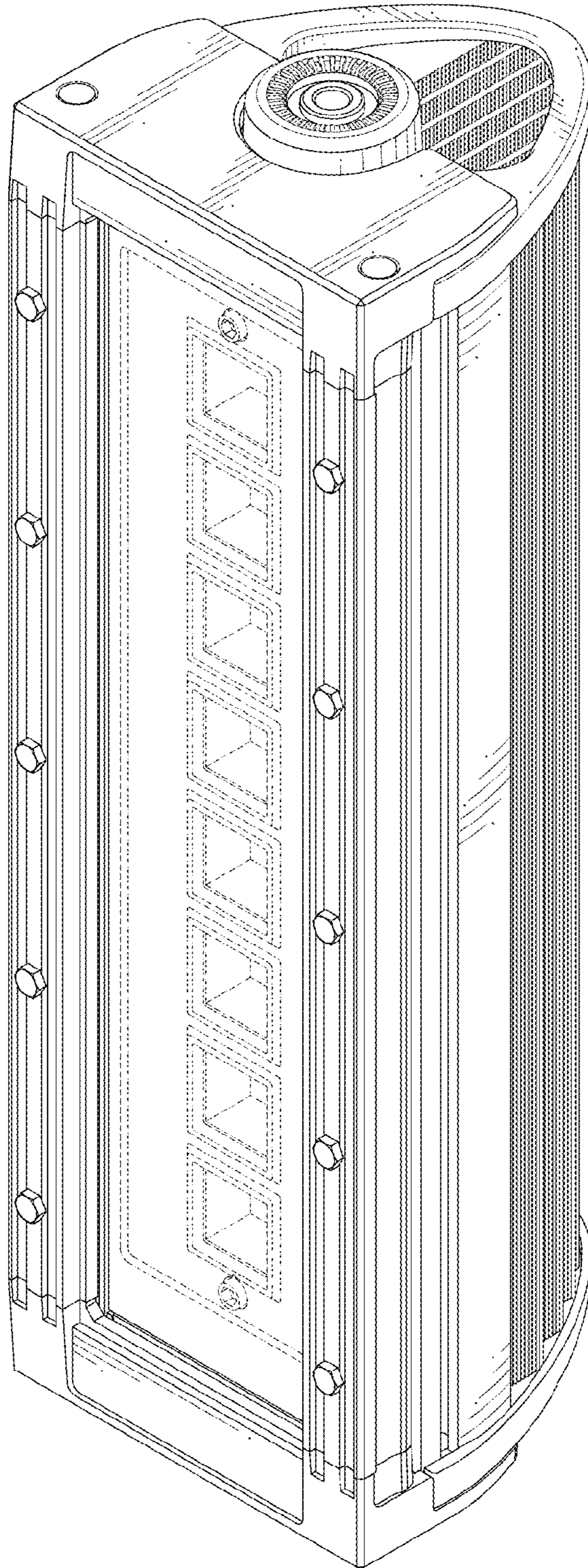

FIG. 13