



US00D762307S

(12) **United States Design Patent**  
**Fagerstrom**

(10) **Patent No.:** **US D762,307 S**

(45) **Date of Patent:** **\*\* Jul. 26, 2016**

(54) **STRESS RELIEF DEVICE**

(71) Applicant: **Acta est fabula AB**, Stockholm (SE)

(72) Inventor: **Kristoffer Fagerstrom**, Stockholm (SE)

(73) Assignee: **ACTA EST FABULA AB**, Stockholm (SE)

(\*\*) Term: **14 Years**

(21) Appl. No.: **29/474,390**

(22) Filed: **Sep. 3, 2014**

(51) **LOC (10) Cl.** ..... **21-02**

(52) **U.S. Cl.**  
USPC ..... **D24/200**

(58) **Field of Classification Search**  
USPC ..... D24/200, 204, 206–215; D21/500, 504,  
D21/505, 662, 671, 684, 686, 688, 692,  
D21/694; 482/10, 11, 44–49, 121  
CPC ..... A63B 6/00; A63B 6/02; A63B 6/08;  
A63B 6/11

See application file for complete search history.

(56) **References Cited**

**U.S. PATENT DOCUMENTS**

D156,301 S \* 11/1949 Werner et al. .... D24/215  
D164,759 S \* 10/1951 Bartolucci ..... D24/183  
D193,964 S \* 10/1962 Gillman ..... D24/200

(Continued)

**OTHER PUBLICATIONS**

Omni Massage Roller. Core Products International, Inc. First review posted on Feb. 27, 2012 [retrieved on Dec. 3, 2015] Retrieved from the Internet: URL <<http://www.coreproducts.com/review/product/list/id/1404/>>.\*

*Primary Examiner* — Catheri Oliver-Garcia

*Assistant Examiner* — Rebekah Caruso

(74) *Attorney, Agent, or Firm* — Moore & Van Allen PLLC; W. Kevin Ransom

(57) **CLAIM**

The ornamental design for a stress relief device, as shown and described.

**DESCRIPTION**

FIG. 1 is a perspective view of a stress relief device in accordance with a first embodiment;

FIG. 2 is a top view of the stress relief device of FIG. 1;

FIG. 3 is a bottom view of the stress relief device of FIG. 1; FIG. 4 is a side view of the right side of the stress relief device of FIG. 1;

FIG. 5 is a side view of the left side of the stress relief device of FIG. 1;

FIG. 6 is a front view of the stress relief device of FIG. 1;

FIG. 7 is an inverted rear view of the stress relief device of FIG. 1;

FIG. 8 is another perspective view of the stress relief device of FIG. 1;

FIG. 9 is a perspective view of a stress relief device in accordance with a second embodiment;

FIG. 10 is a top view of the stress relief device of FIG. 9;

FIG. 11 is a bottom view of the stress relief device of FIG. 9;

FIG. 12 is a side view of the right side of the stress relief device of FIG. 9;

FIG. 13 is a side view of the left side of the stress relief device of FIG. 9;

FIG. 14 is a front view of the stress relief device of FIG. 9;

FIG. 15 is an inverted rear view of the stress relief device of FIG. 9; and,

FIG. 16 is another perspective view of the stress relief device of FIG. 9.

The surface shading, if any, illustrated in the drawings is provided merely to highlight the contour of the design; it is not intended to be illustrative of texture or gloss.

**1 Claim, 16 Drawing Sheets**

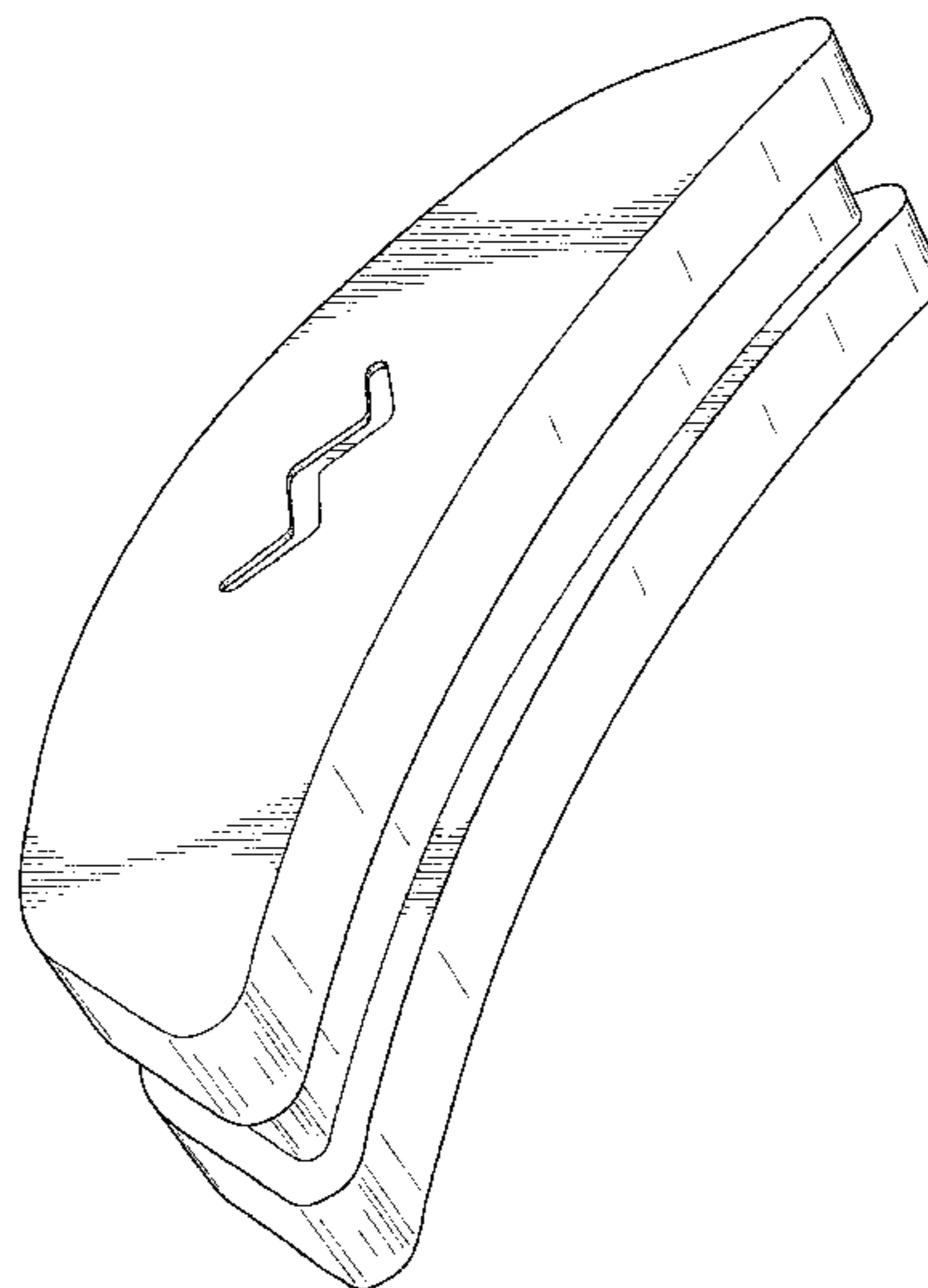

(56)

**References Cited**

U.S. PATENT DOCUMENTS

D275,607 S \* 9/1984 Blackman ..... D24/188  
D312,694 S \* 12/1990 Yanazaki ..... D24/215  
D326,913 S \* 6/1992 Staples ..... D24/188  
5,540,642 A \* 7/1996 Sprague ..... A63B 23/03533  
482/123

D449,695 S \* 10/2001 Ponton ..... D24/200  
D523,913 S \* 6/2006 Van Straaten ..... D21/662  
D526,033 S \* 8/2006 Van Straaten ..... D21/662  
D571,871 S \* 6/2008 Backstrand ..... D21/686  
D583,884 S \* 12/2008 Zickert ..... D21/684  
2013/0102938 A1 \* 4/2013 Chen ..... A61H 7/004  
601/84

\* cited by examiner

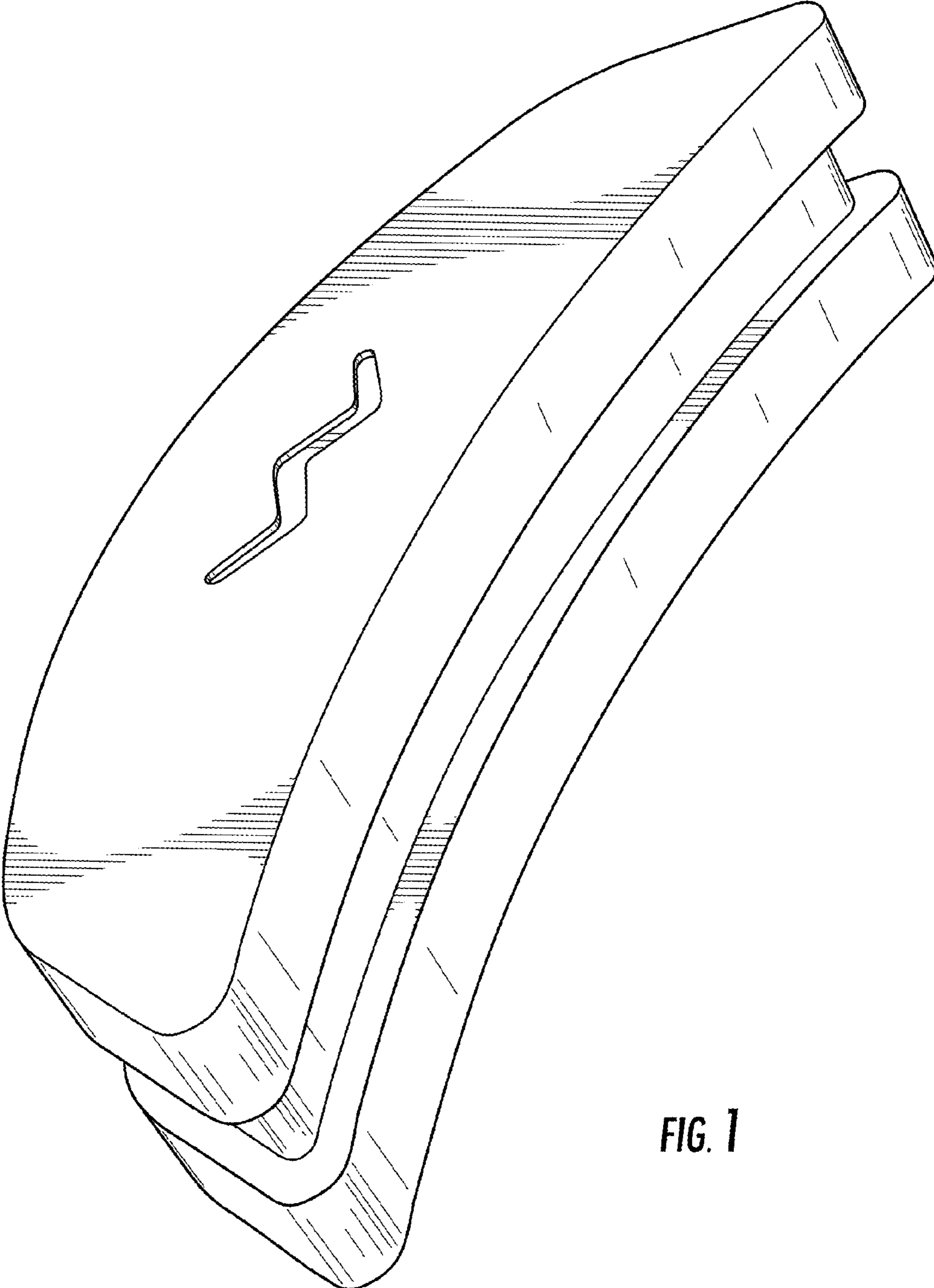

FIG. 1

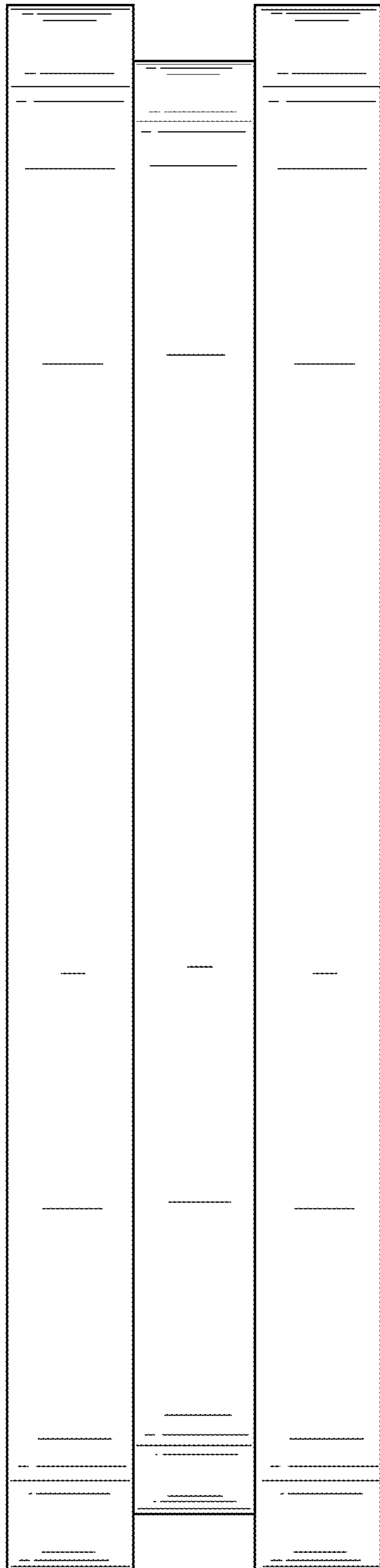

FIG. 2

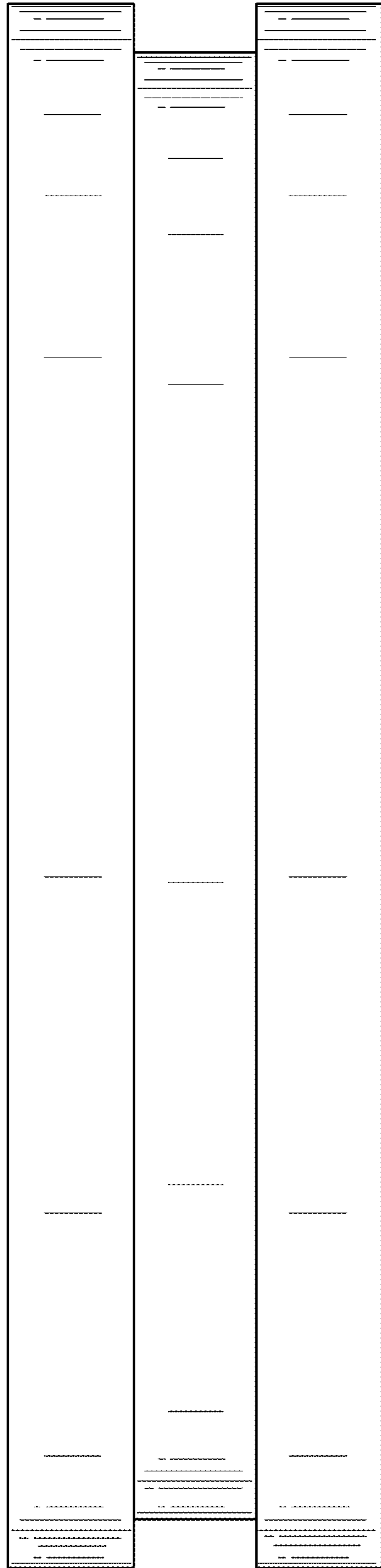
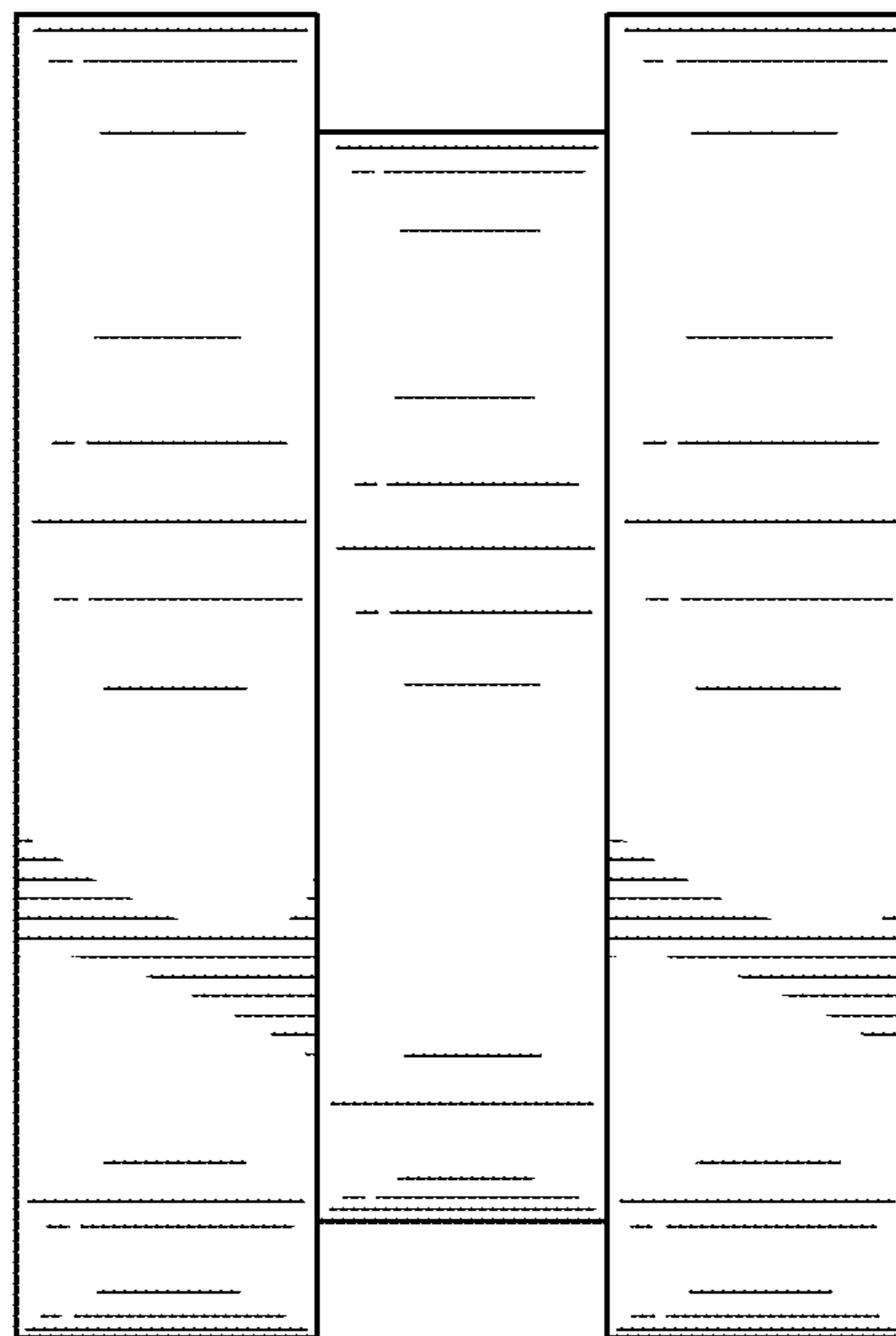
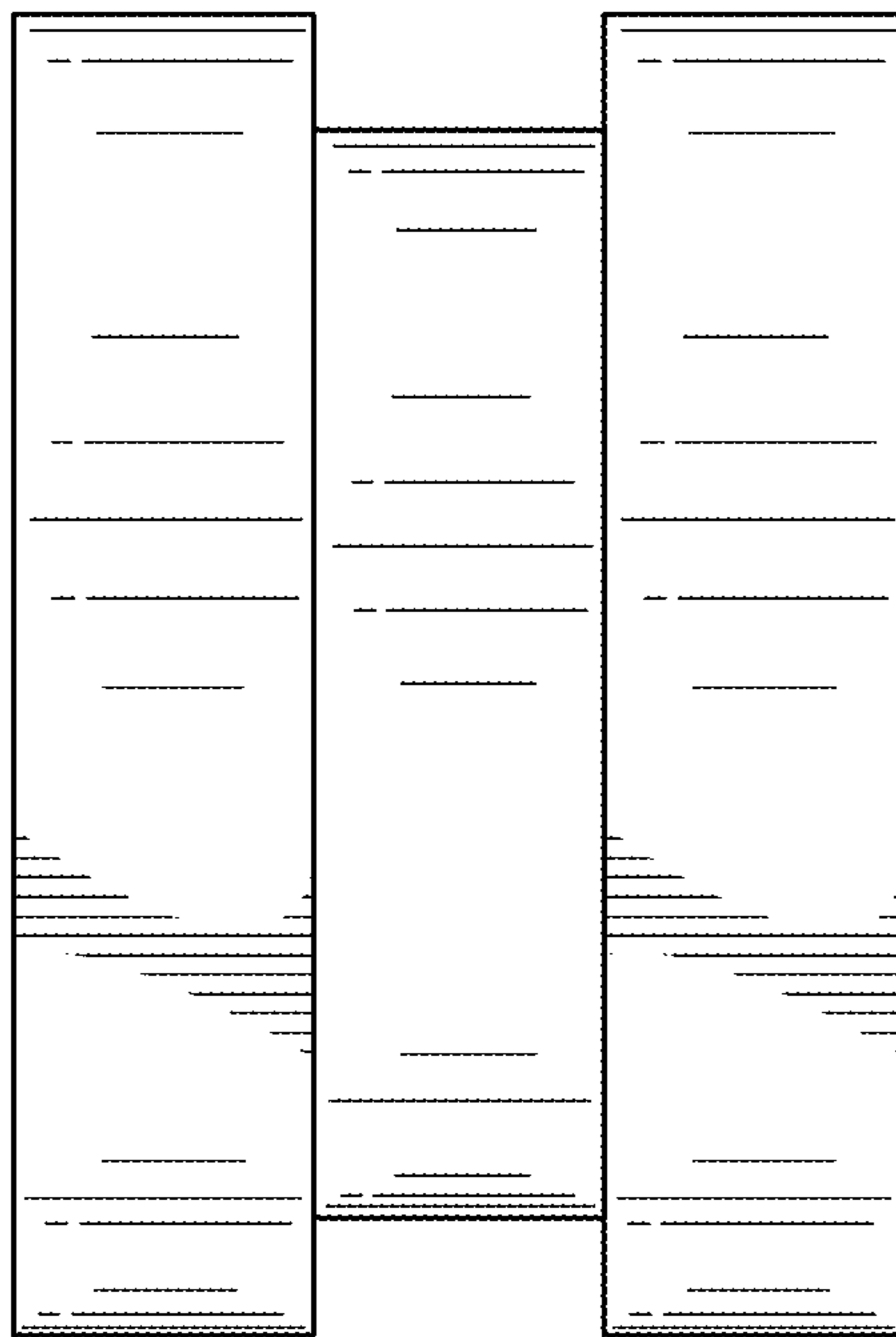

FIG. 3



**FIG. 4**



**FIG. 5**

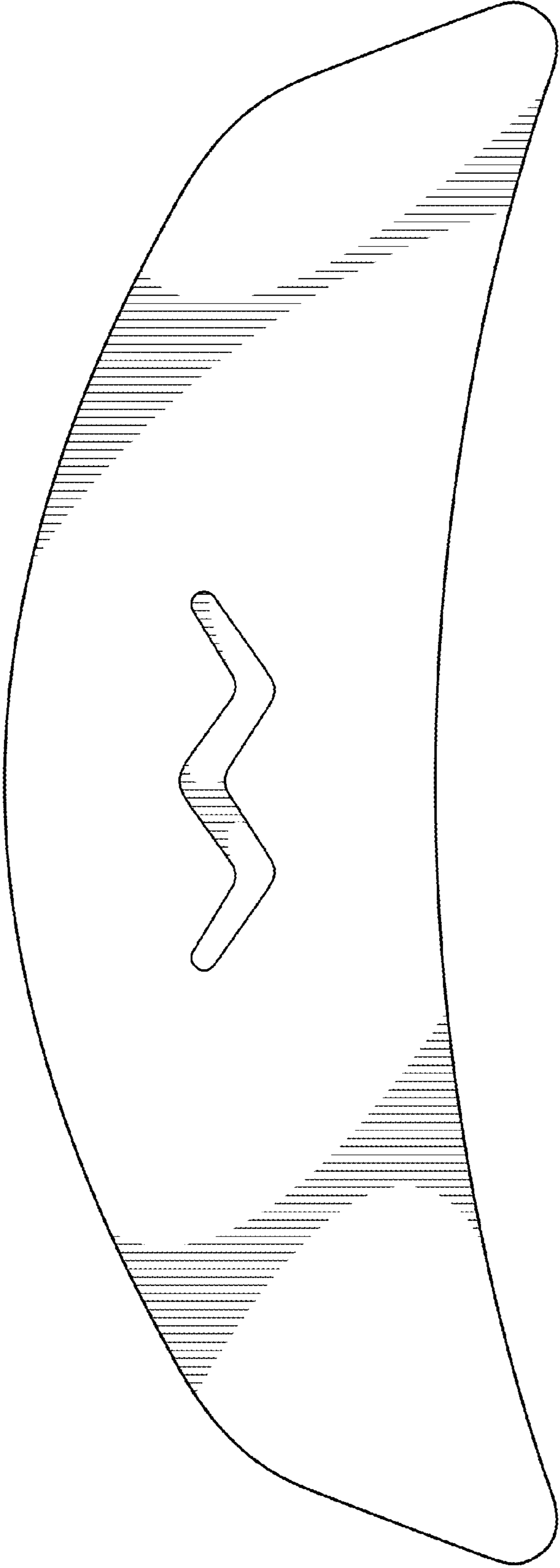

FIG. 6



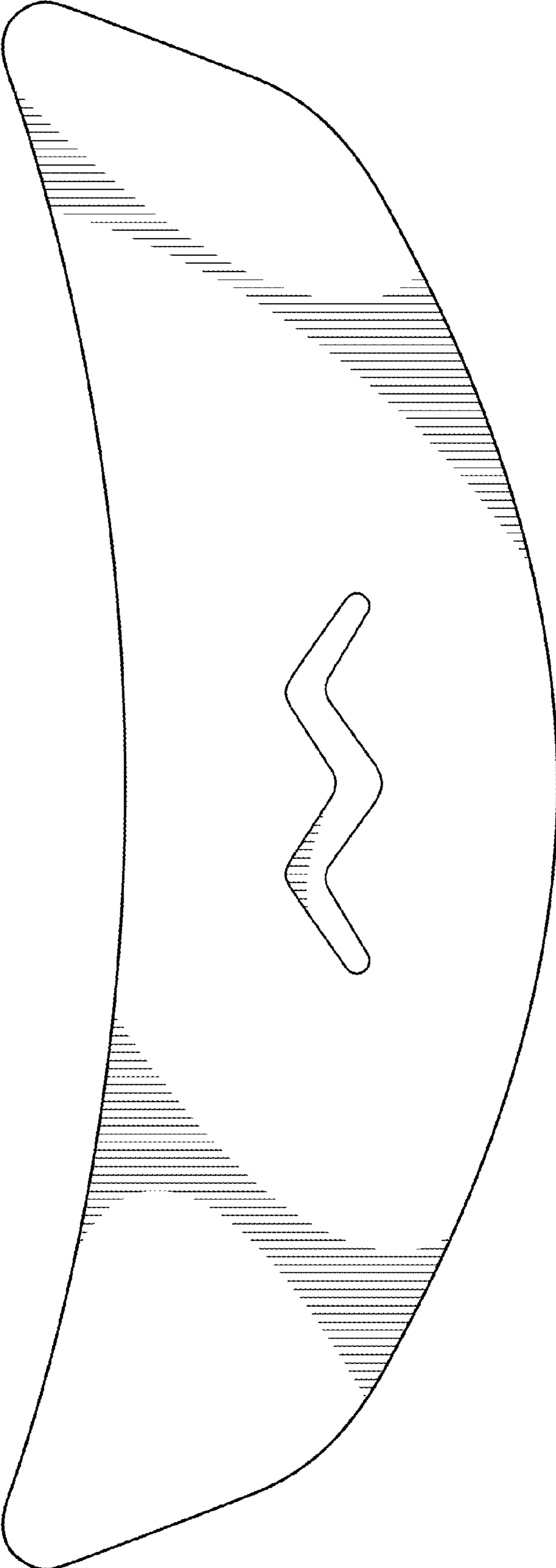

FIG. 7

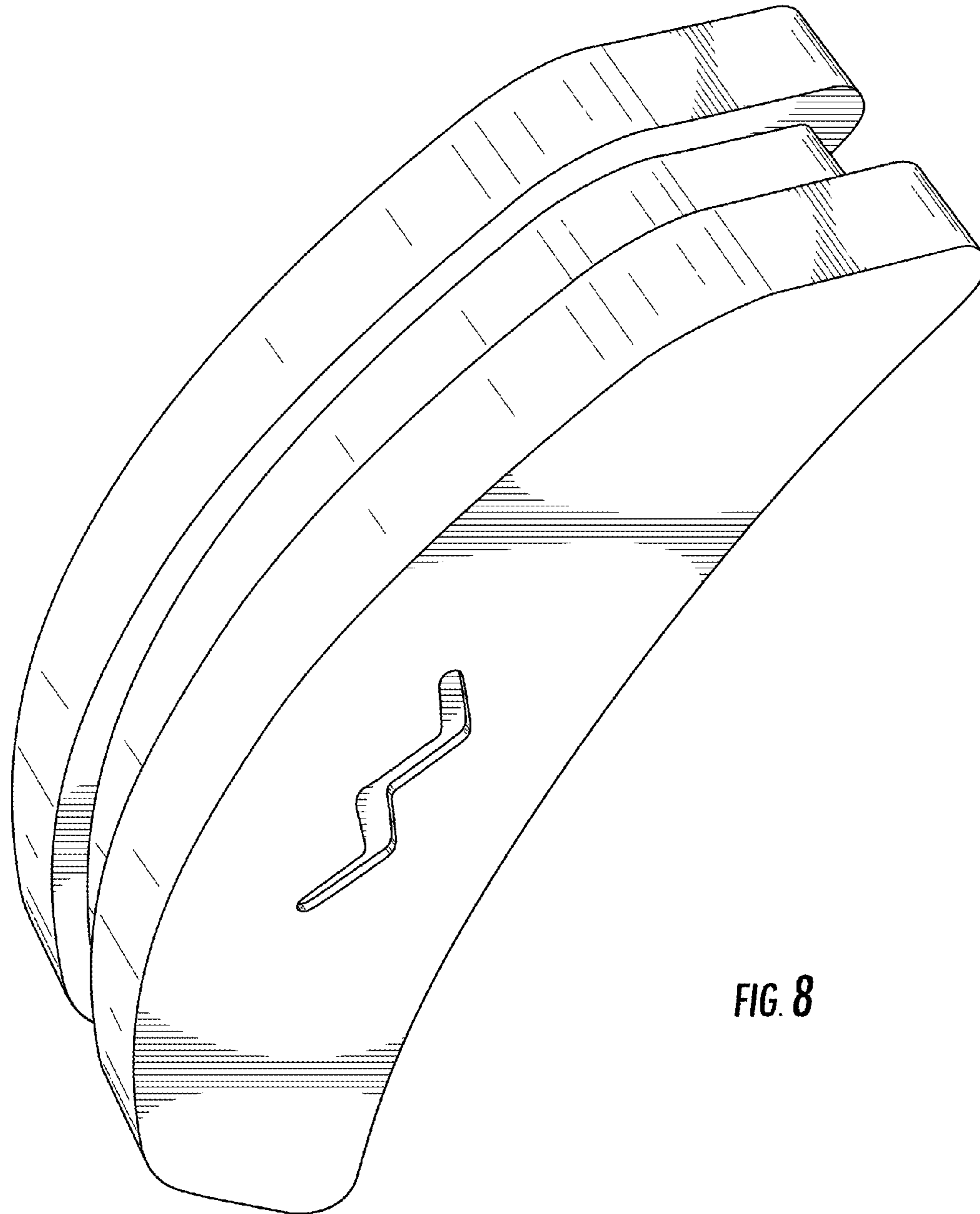

FIG. 8

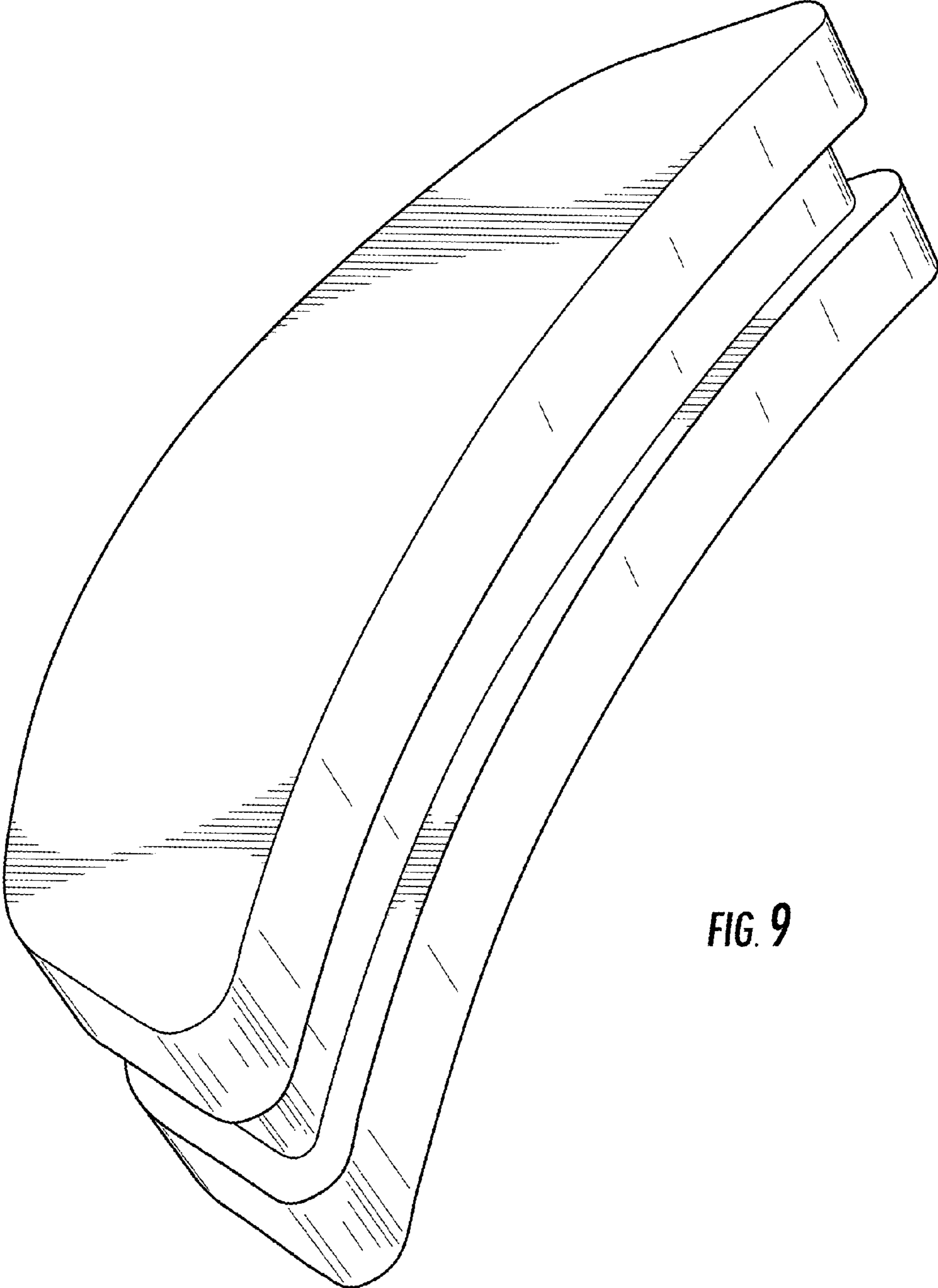
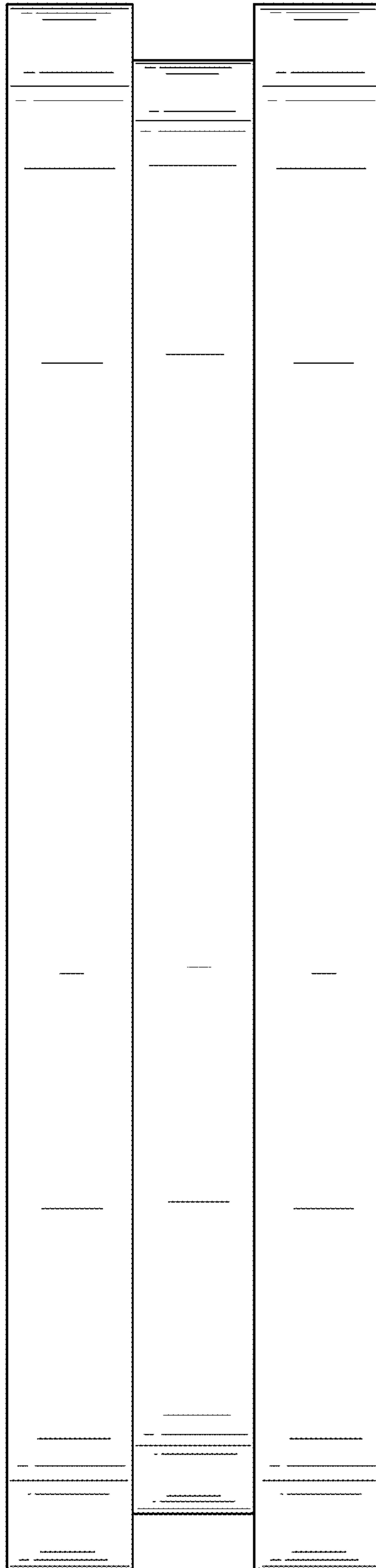
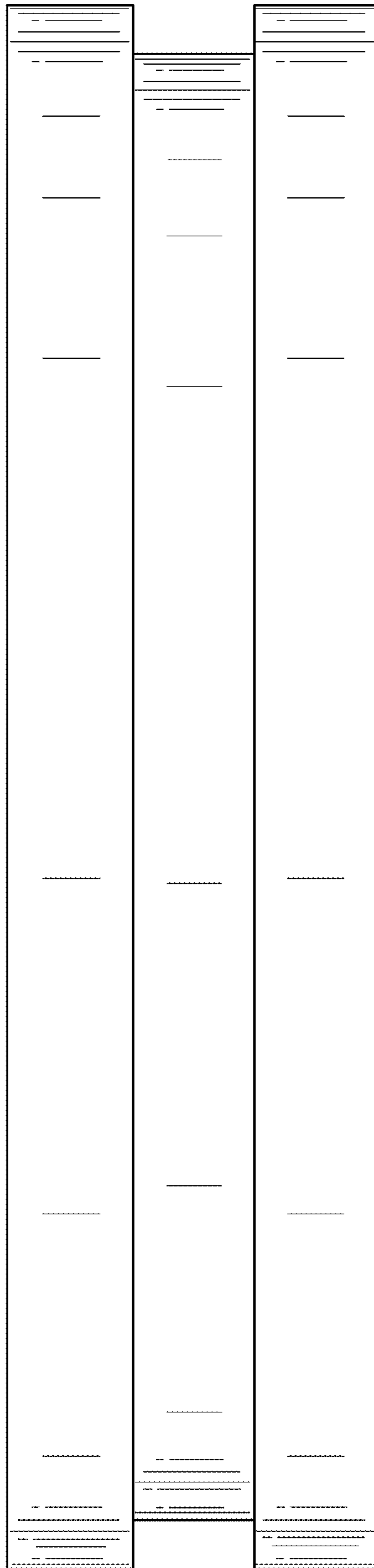

FIG. 9



**FIG. 10**



**FIG. 11**

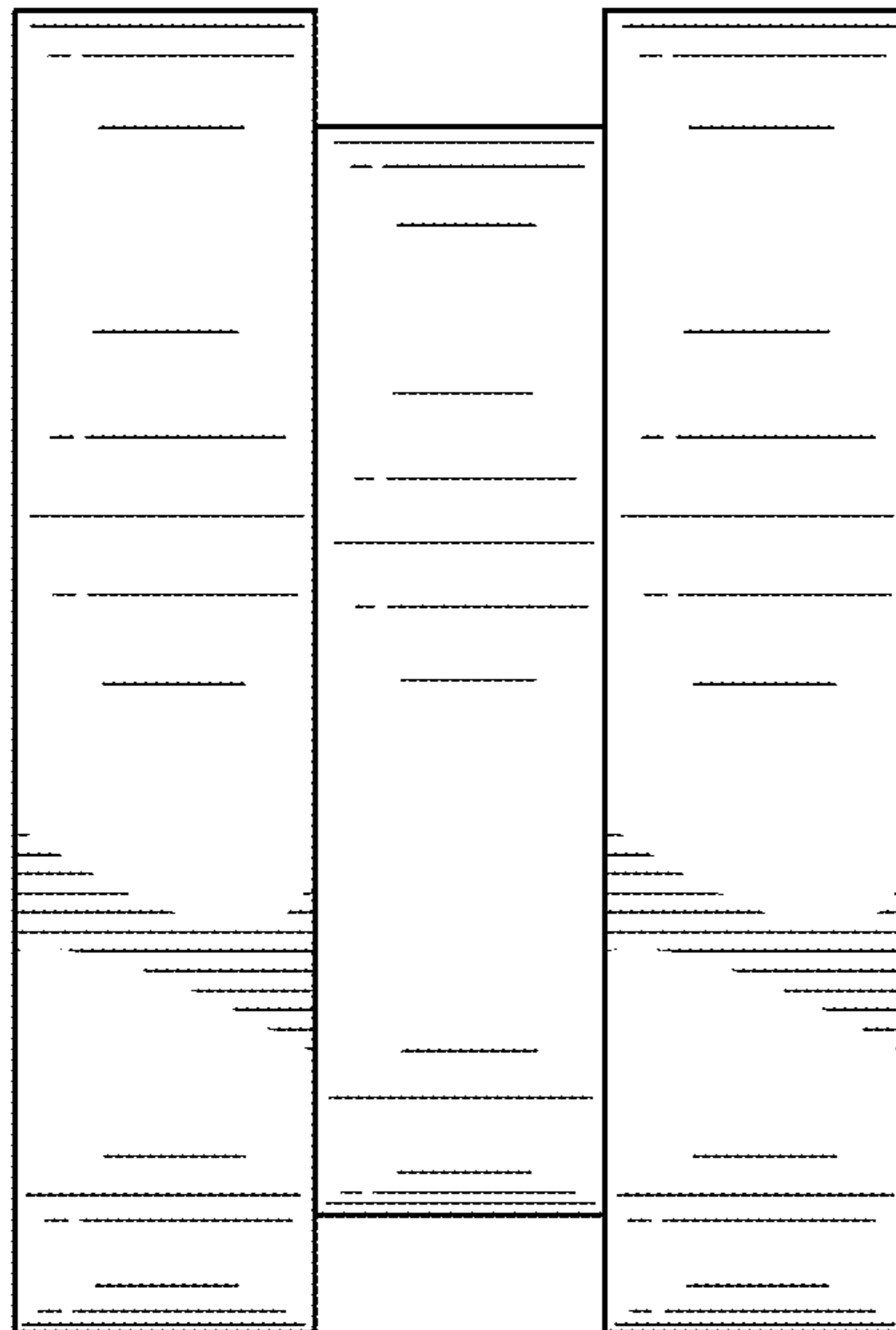

**FIG. 12**

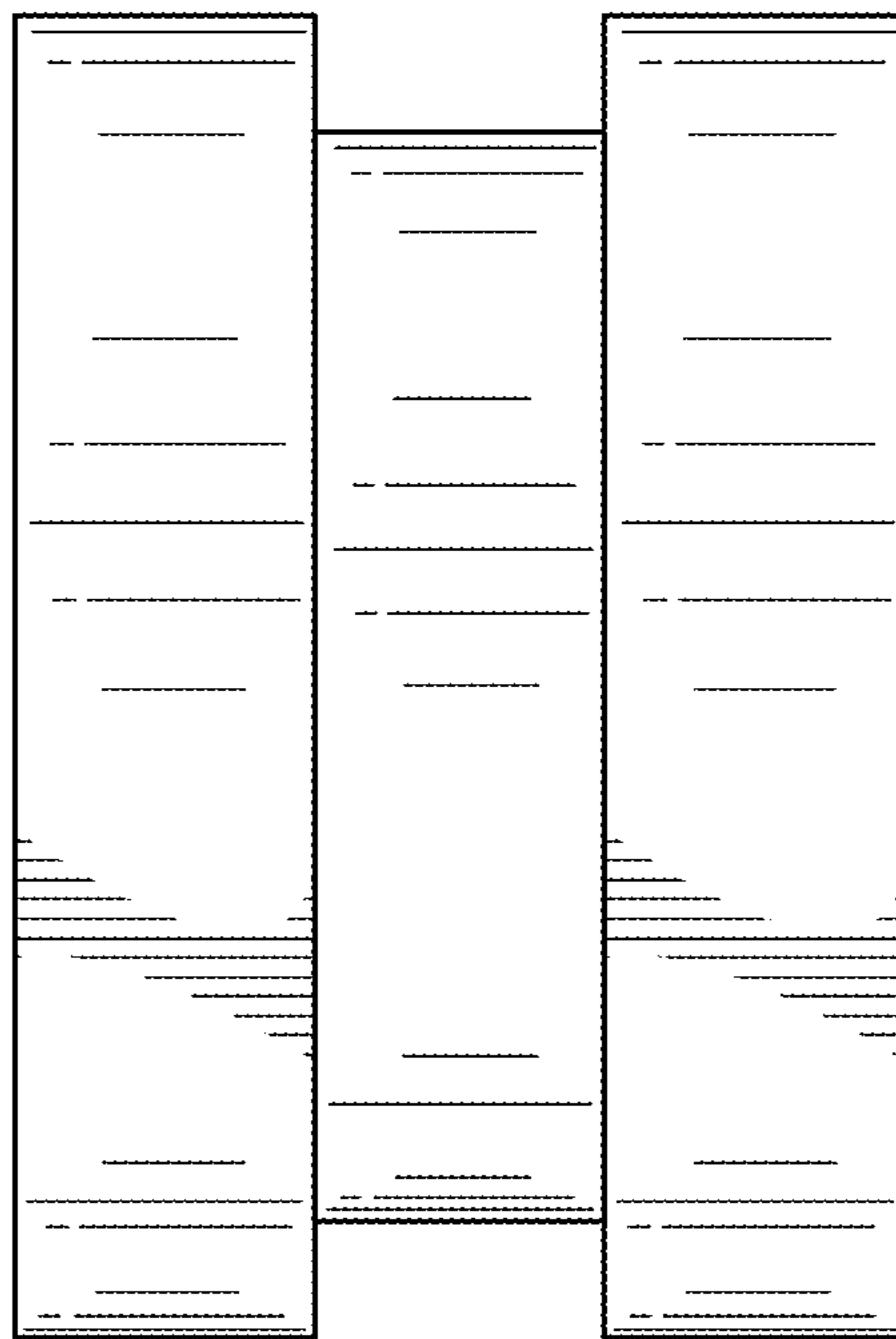

**FIG. 13**

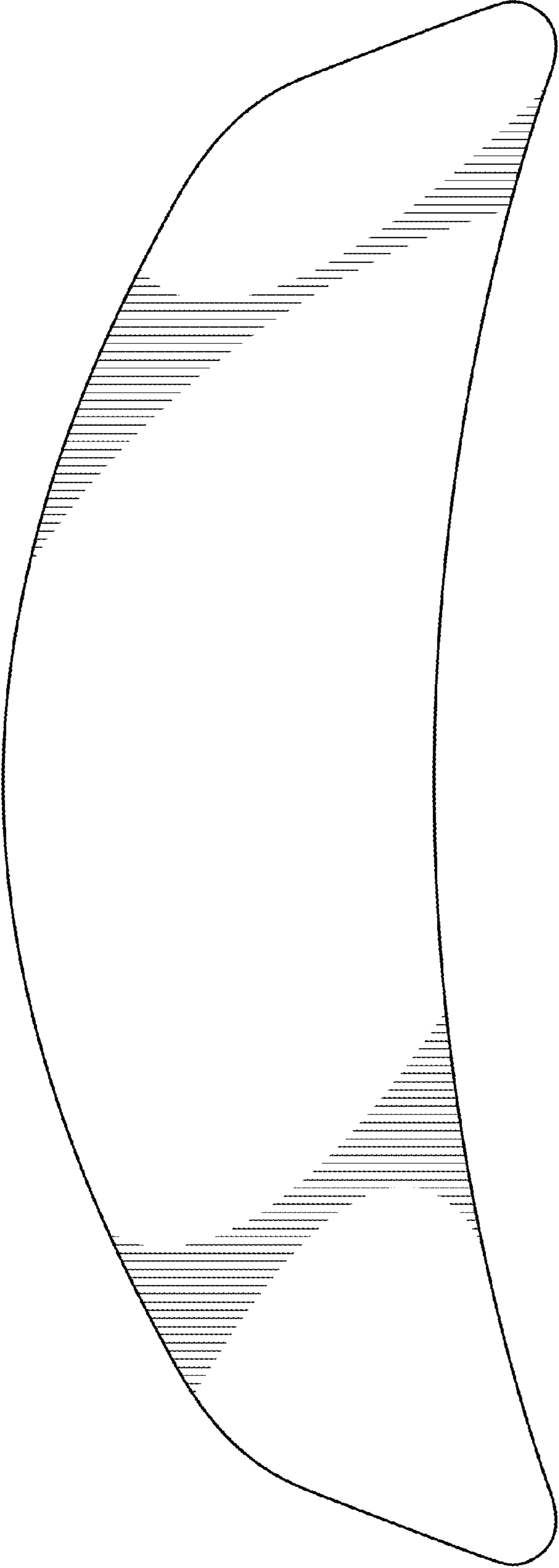

FIG. 14



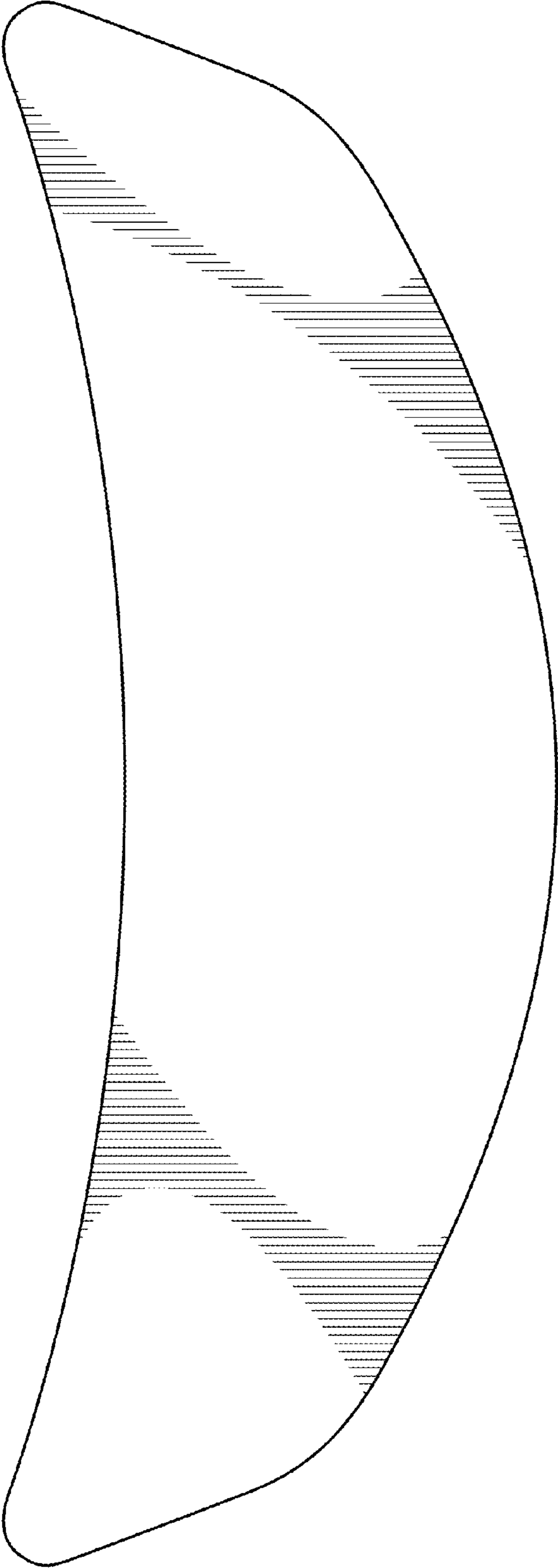

FIG. 15

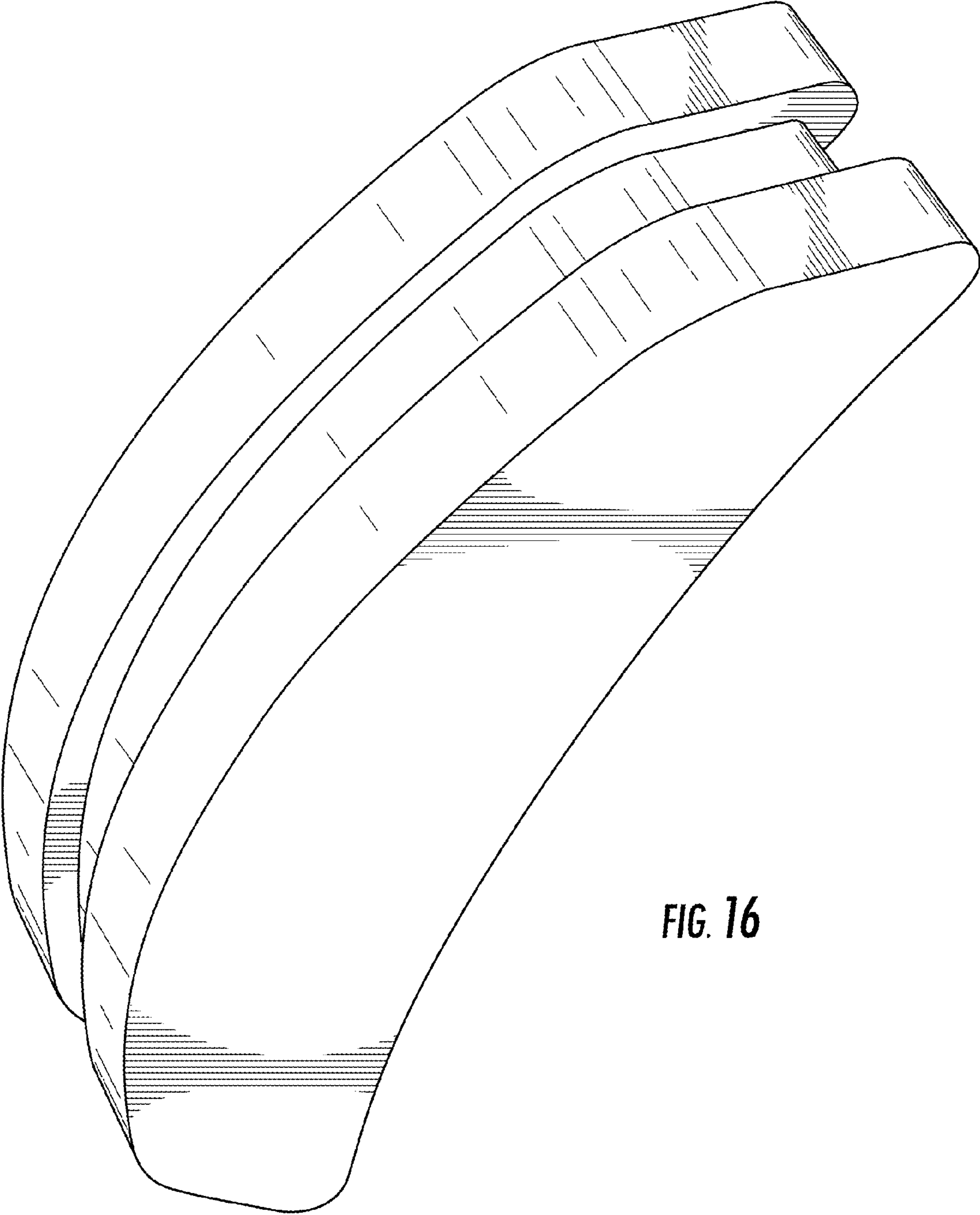

FIG. 16