



US00D762250S

(12) **United States Design Patent**
McConnell et al.

(10) **Patent No.:** **US D762,250 S**
(45) **Date of Patent:** **** Jul. 26, 2016**

(54) **COMBINED APPLIANCE DRAWER AND INTERIOR LINER WITH COLOR**

(71) Applicant: **Whirlpool Corporation**, Benton Harbor, MI (US)

(72) Inventors: **Jessica R. McConnell**, St. Joseph, MI (US); **Daniel Henry Quinlan**, Stevensville, MI (US); **Kelly E. Roche**, St. Joseph, MI (US); **Michael S. Seeley**, South Haven, MI (US)

(73) Assignee: **Whirlpool Corporation**, Benton Harbor, MI (US)

(**) Term: **14 Years**

(21) Appl. No.: **29/485,361**

(22) Filed: **Mar. 18, 2014**

(51) **LOC (10) Cl.** **15-07**

(52) **U.S. Cl.**
USPC **D15/89**

(58) **Field of Classification Search**
USPC D15/79, 81, 84, 85, 86, 88, 89, 91
CPC F25D 2323/02; F25D 2323/021; F25D 2317/06; F25D 2317/062; F25D 2323/121; F25D 2323/122; F25D 2331/806; F25D 2400/36; F25D 13/02; F25D 13/04; F25D 11/02; F25D 11/025

See application file for complete search history.

(56) **References Cited**

U.S. PATENT DOCUMENTS

D508,249 S *	8/2005	Seok	D15/86
D511,177 S *	11/2005	Jackovin	D15/89
D511,179 S *	11/2005	Tunzi	D15/89
D518,832 S *	4/2006	Park	D15/81
D629,819 S *	12/2010	Placke	D15/89
D639,315 S *	6/2011	Yang	D15/85
D647,927 S *	11/2011	Lee	D15/85
D654,515 S *	2/2012	Hwang	D15/85
D655,321 S *	3/2012	Lee	D15/86
D707,735 S *	6/2014	Cho	D15/91
D710,401 S *	8/2014	Ringemann	D15/85

D710,402 S *	8/2014	Jeon	D15/86
D716,851 S *	11/2014	Seo	D15/89
D718,346 S *	11/2014	Cho	D15/81
D718,349 S *	11/2014	Cho	D15/85
D731,561 S *	6/2015	McConnell	D15/89
D732,088 S *	6/2015	McConnell	D15/89
D732,585 S *	6/2015	McConnell	D15/89
D733,194 S *	6/2015	McConnell	D15/89
D735,783 S *	8/2015	McConnell	D15/89
D742,942 S *	11/2015	McConnell	D15/89
D743,453 S *	11/2015	McConnell	D15/89
D749,152 S *	2/2016	McConnell	D15/89

* cited by examiner

Primary Examiner — Ian Simmons

Assistant Examiner — Khawaja Anwar

(57) **CLAIM**

We claim the ornamental design for a combined appliance drawer and interior liner with color, as shown and described.

DESCRIPTION

FIG. 1 is a perspective view of the outside of a combined appliance drawer and interior liner with color, showing my new design;

FIG. 2 is a front elevation view thereof;

FIG. 3 is a left side elevation view thereof;

FIG. 4 is a top a plan view thereof;

FIG. 5 is a bottom plan view thereof;

FIG. 6 is a front perspective view of a combined appliance drawer and interior liner with color, in an open configuration;

FIG. 7 is an enlarged perspective of the left side of a combined appliance drawer and interior liner with color;

FIG. 8 is an enlarged perspective of the right side of a combined appliance drawer and interior liner with color;

FIG. 9 is an enlarged front elevation view of a combined appliance drawer and interior liner with color;

FIG. 10 is an isolated perspective view of a left door of a combined appliance drawer and interior liner with color;

FIG. 11 is a front elevation view thereof;

FIG. 12 is another isolated perspective view of a left door, shown in usage condition;

FIG. 13 is a front elevation view thereof;

FIG. 14 is an isolated perspective view of a right door of a combined appliance drawer and interior liner with color;

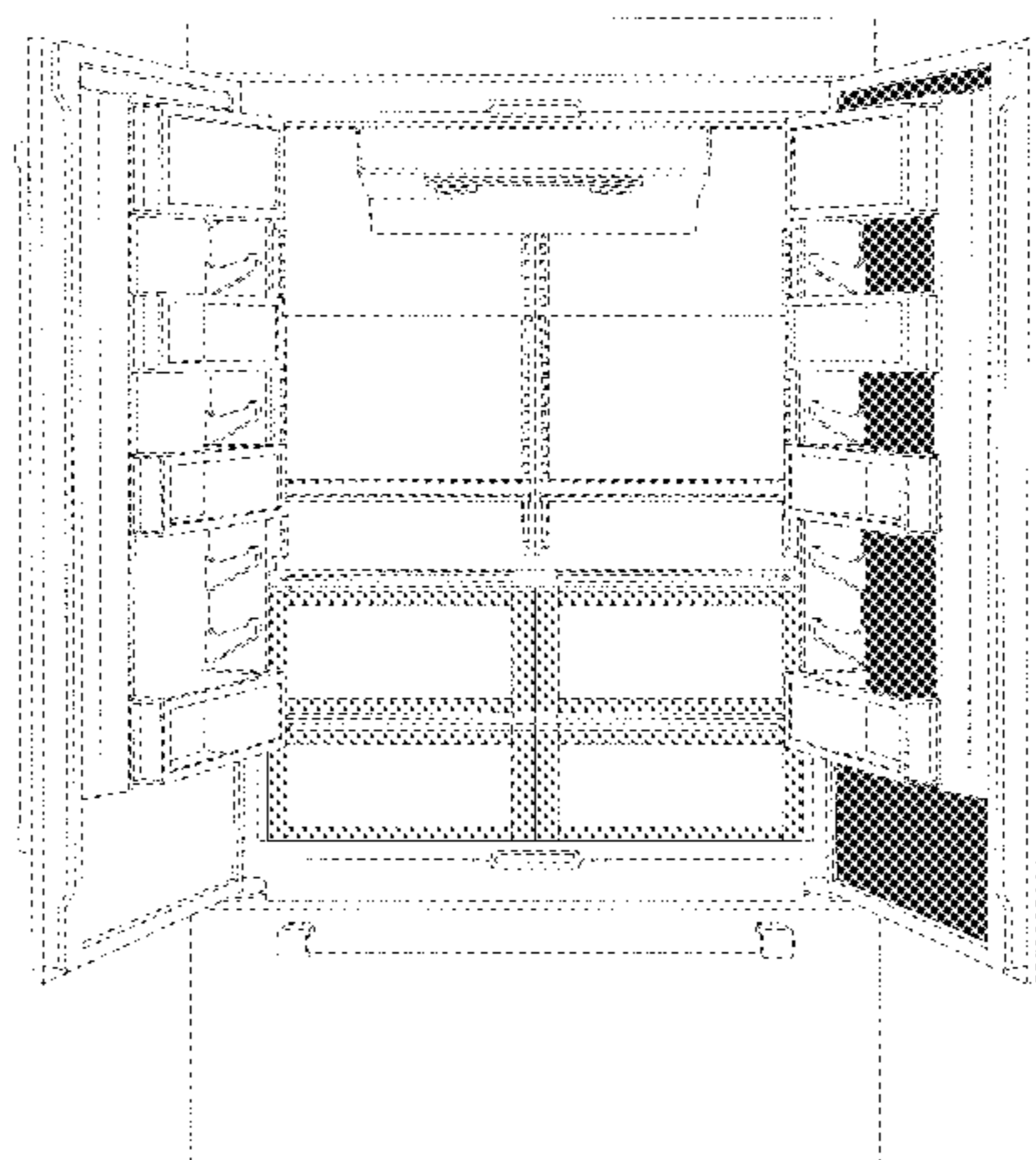
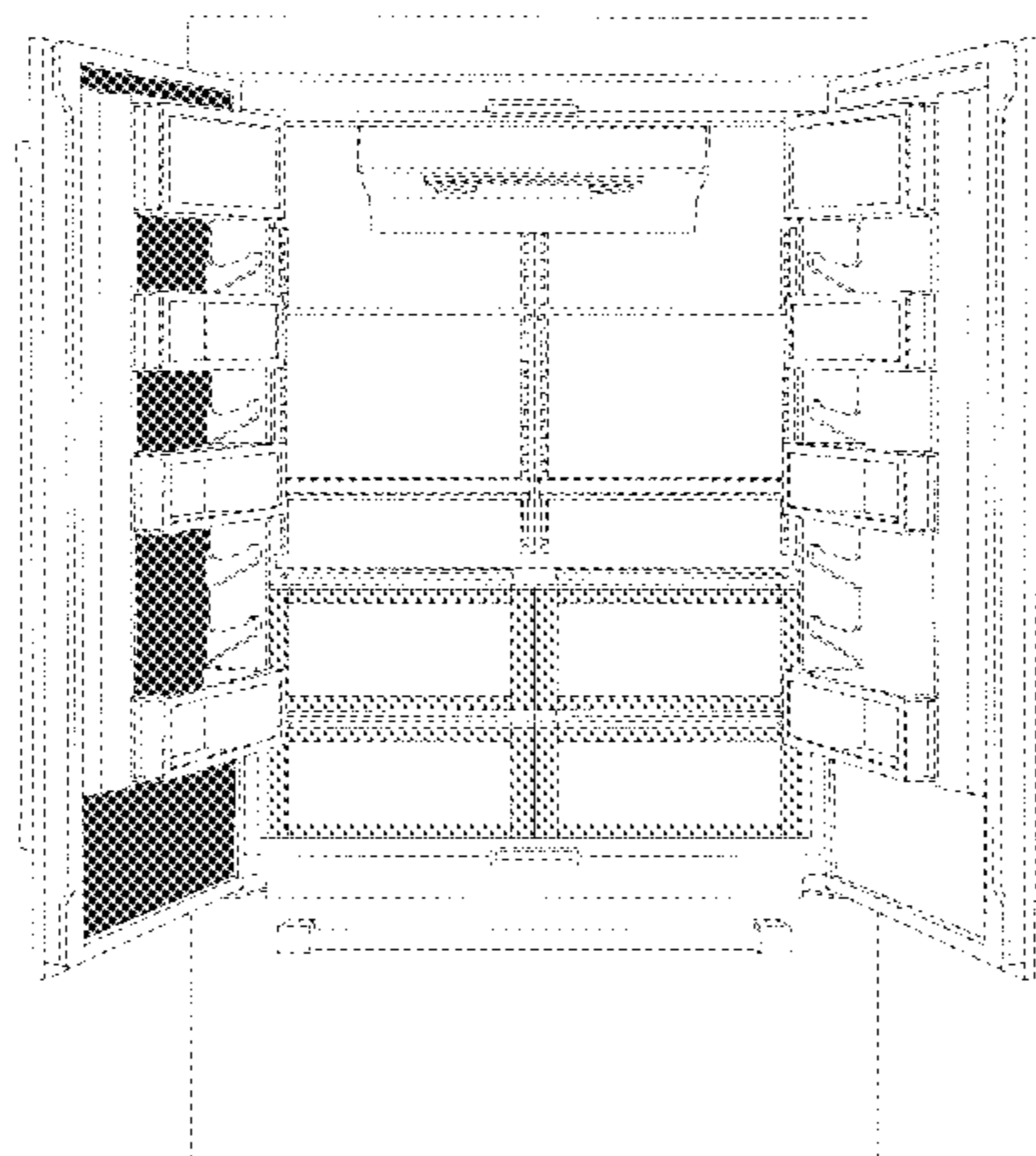

FIG. 15 is a front elevation view thereof;
FIG. 16 is another isolated perspective view of a right door, shown in usage condition;
FIG. 17 is a front elevation view thereof;
FIG. 18 is a perspective view of the outside of a combined appliance drawer and interior liner with color, showing my new design, according to a second embodiment of the present invention;
FIG. 19 is a front elevation view thereof;
FIG. 20 is a left side elevation view thereof;
FIG. 21 is a top a plan view thereof;
FIG. 22 is a bottom plan view thereof;
FIG. 23 is a front perspective view of a combined appliance drawer and interior liner with color, in an open configuration;
FIG. 24 is an enlarged perspective of the left side of a combined appliance drawer and interior liner with color;
FIG. 25 is an enlarged perspective of the right side of a combined appliance drawer and interior liner with color;
FIG. 26 is an enlarged front elevation view of a combined appliance drawer and interior liner with color;
FIG. 27 is an isolated perspective view of a left door of a combined appliance drawer and interior liner with color;
FIG. 28 is a front elevation view thereof;
FIG. 29 is another isolated perspective view of a left door, shown in usage condition;
FIG. 30 is a front elevation view thereof;
FIG. 31 is an isolated perspective view of a right door of a combined appliance drawer and interior liner with color;
FIG. 32 is a front elevation view thereof;
FIG. 33 is another isolated perspective view of a right door, shown in usage condition;
FIG. 34 is a front elevation view thereof;
FIG. 35 is a perspective view of the outside of a combined appliance drawer and interior liner with color, showing my new design, according to a third embodiment of the present invention;

FIG. 36 is a front elevation view thereof;
FIG. 37 is a left side elevation view thereof;
FIG. 38 is a top a plan view thereof;
FIG. 39 is a bottom plan view thereof;
FIG. 40 is a front perspective view of a combined appliance drawer and interior liner with color, in an open configuration;
FIG. 41 is an enlarged perspective of the left side of a combined appliance drawer and interior liner with color;
FIG. 42 is an enlarged perspective of the right side of a combined appliance drawer and interior liner with color;
FIG. 43 is an enlarged front elevation view of a combined appliance drawer and interior liner with color;
FIG. 44 is an isolated perspective view of a left door of a combined appliance drawer and interior liner with color;
FIG. 45 is a front elevation view thereof;
FIG. 46 is another isolated perspective view of a left door, shown in usage condition;
FIG. 47 is a front elevation view thereof;
FIG. 48 is an isolated perspective view of a right door of a combined appliance drawer and interior liner with color;
FIG. 49 is a front elevation view thereof;
FIG. 50 is another isolated perspective view of a right door, shown in usage condition; and,
FIG. 51 is a front elevation view thereof.
The broken lines in the figures are for contextual purposes or show the environment and form no part of the claimed design. The dark gray shaded interior refrigerator compartment walls shown in FIGS. 6-9 are charcoal gray. The claimed door bin shown in FIGS. 6, 12 and 13 is silver. The front portions of the front drawer doors of the crispers that are shaded are the color silver. The door liner of the left, right or both the left and the right door interior is charcoal gray. The crisper cover is gray where claimed and shaded.

1 Claim, 48 Drawing Sheets

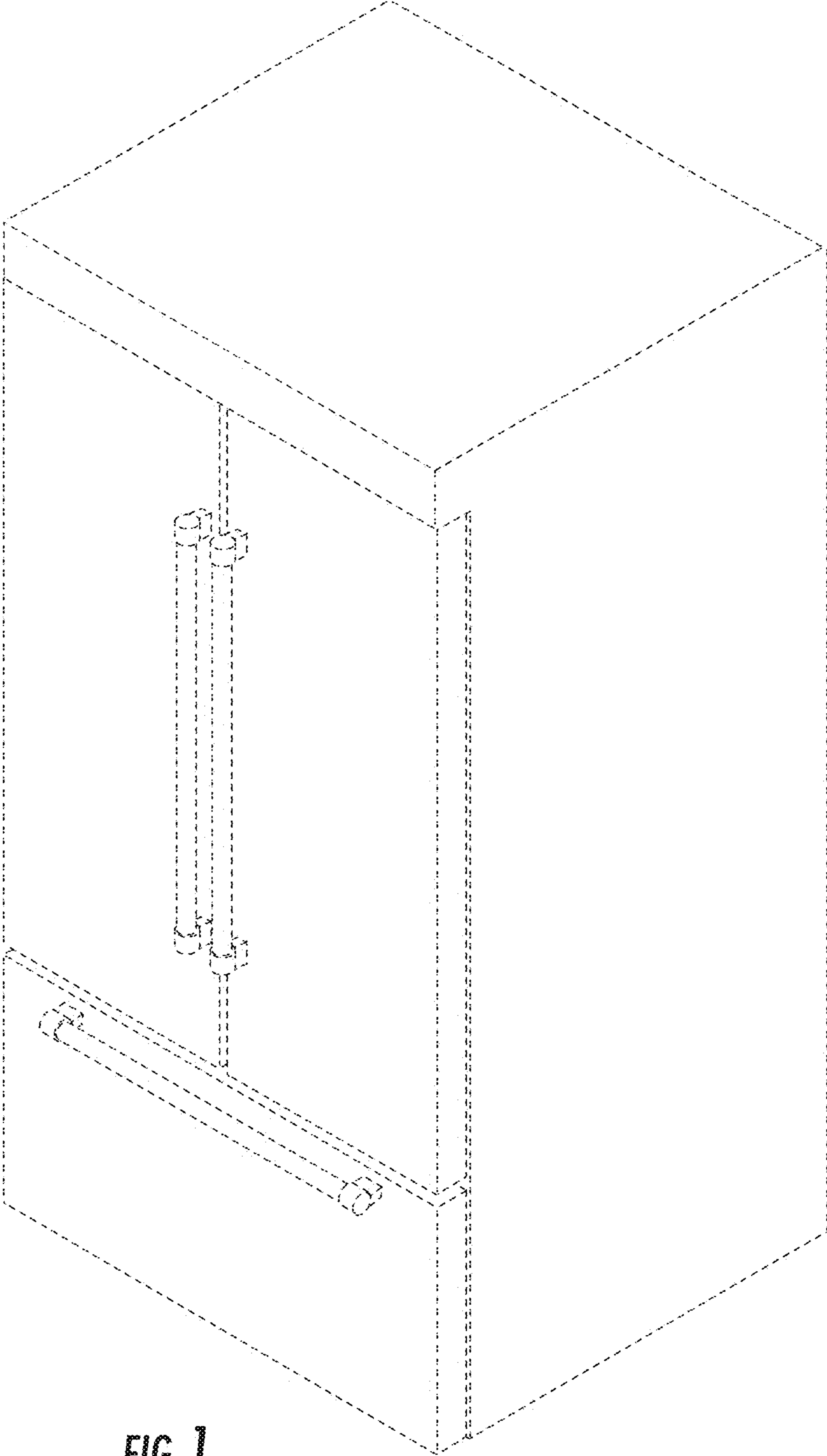

FIG. 1

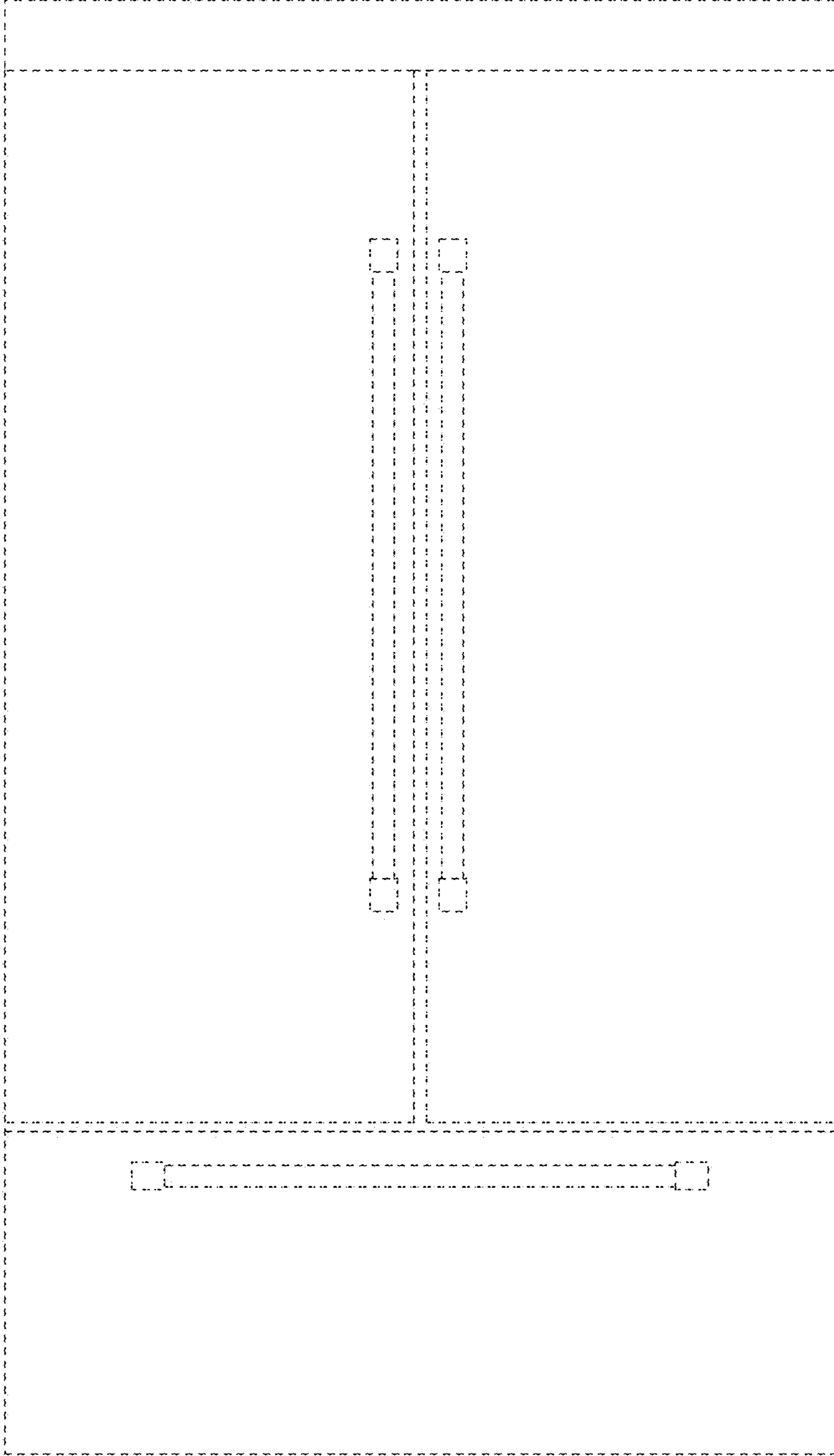

FIG. 2

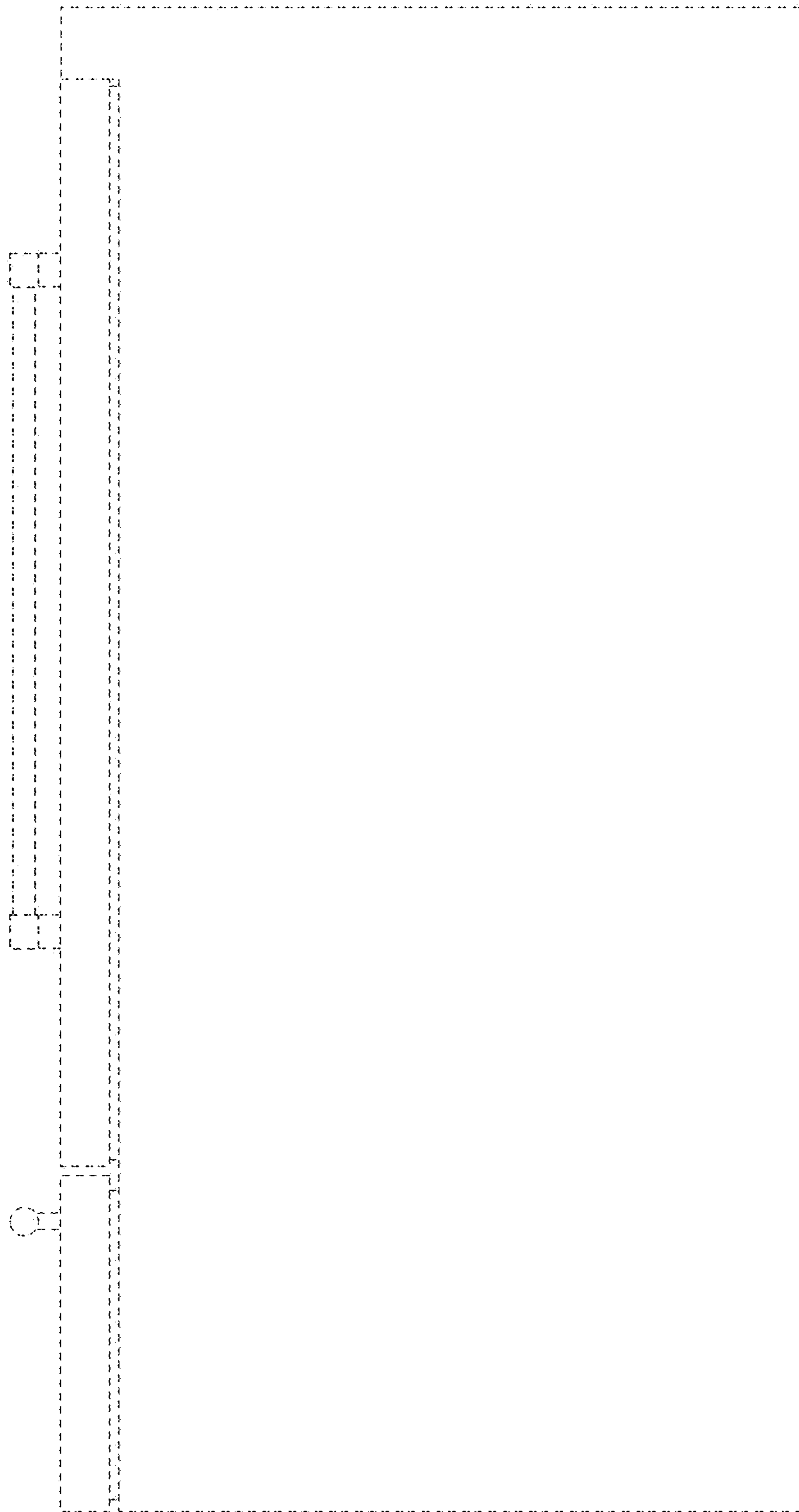

FIG. 3

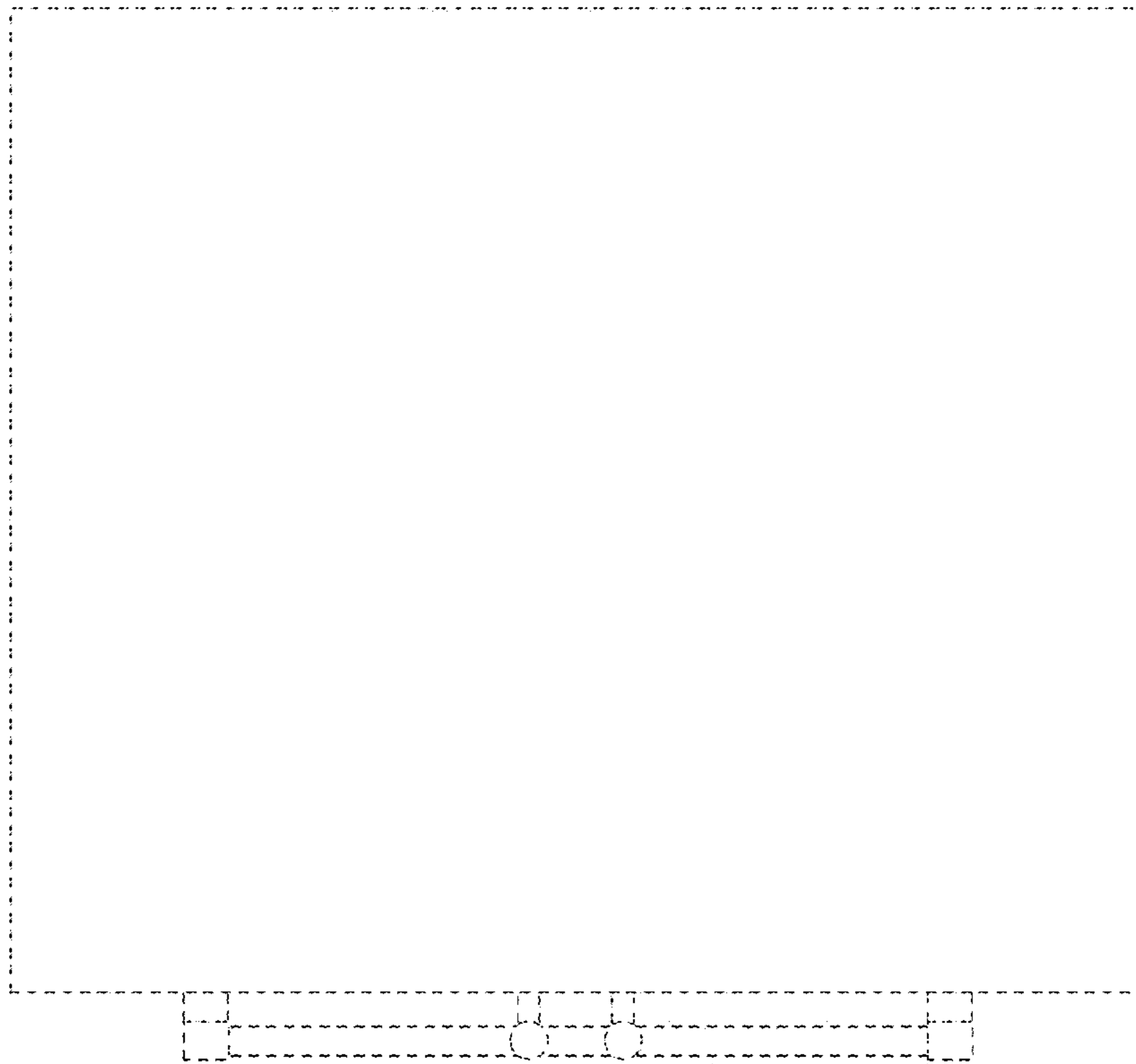

FIG. 4

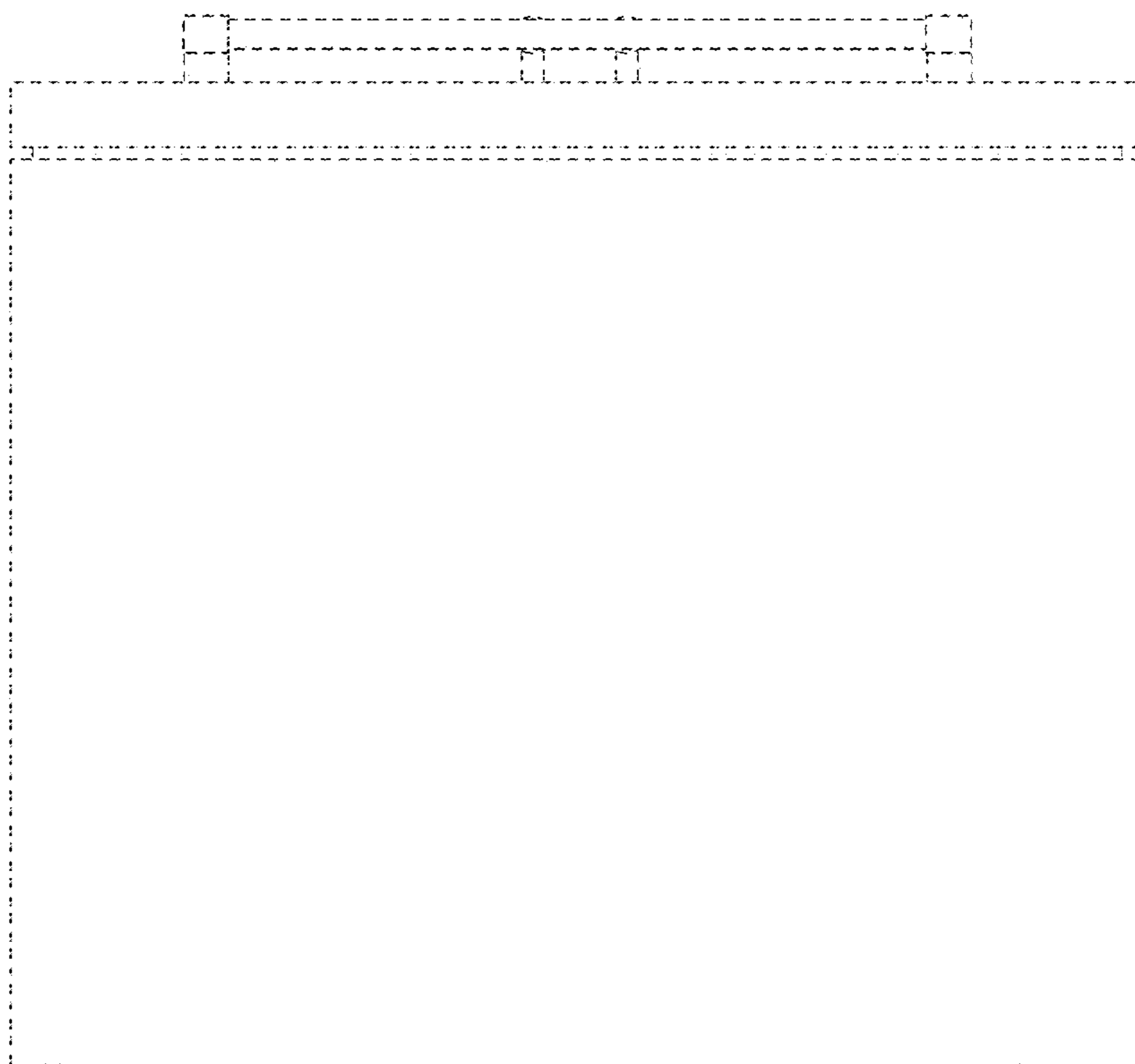

FIG. 5

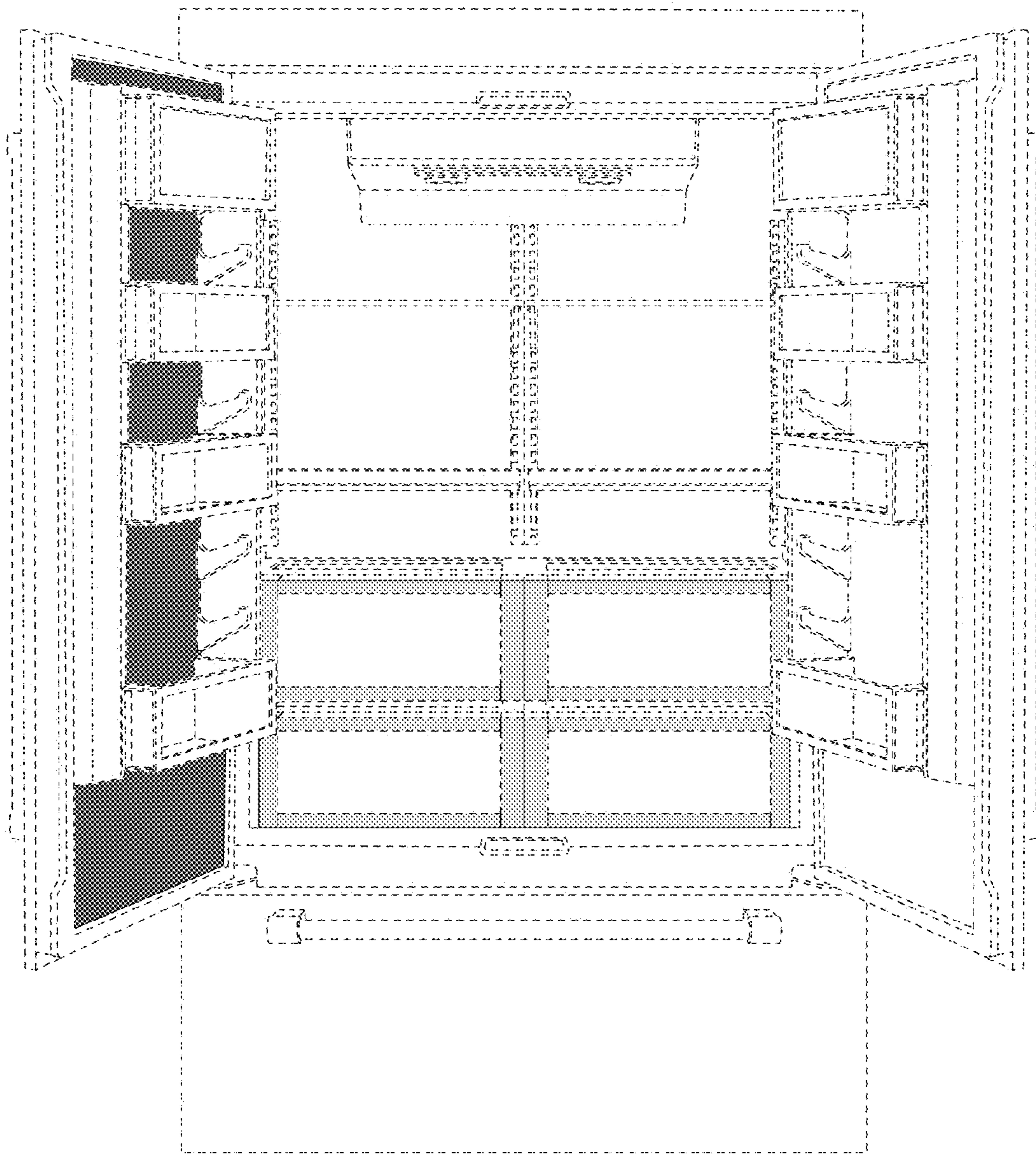

FIG. 6

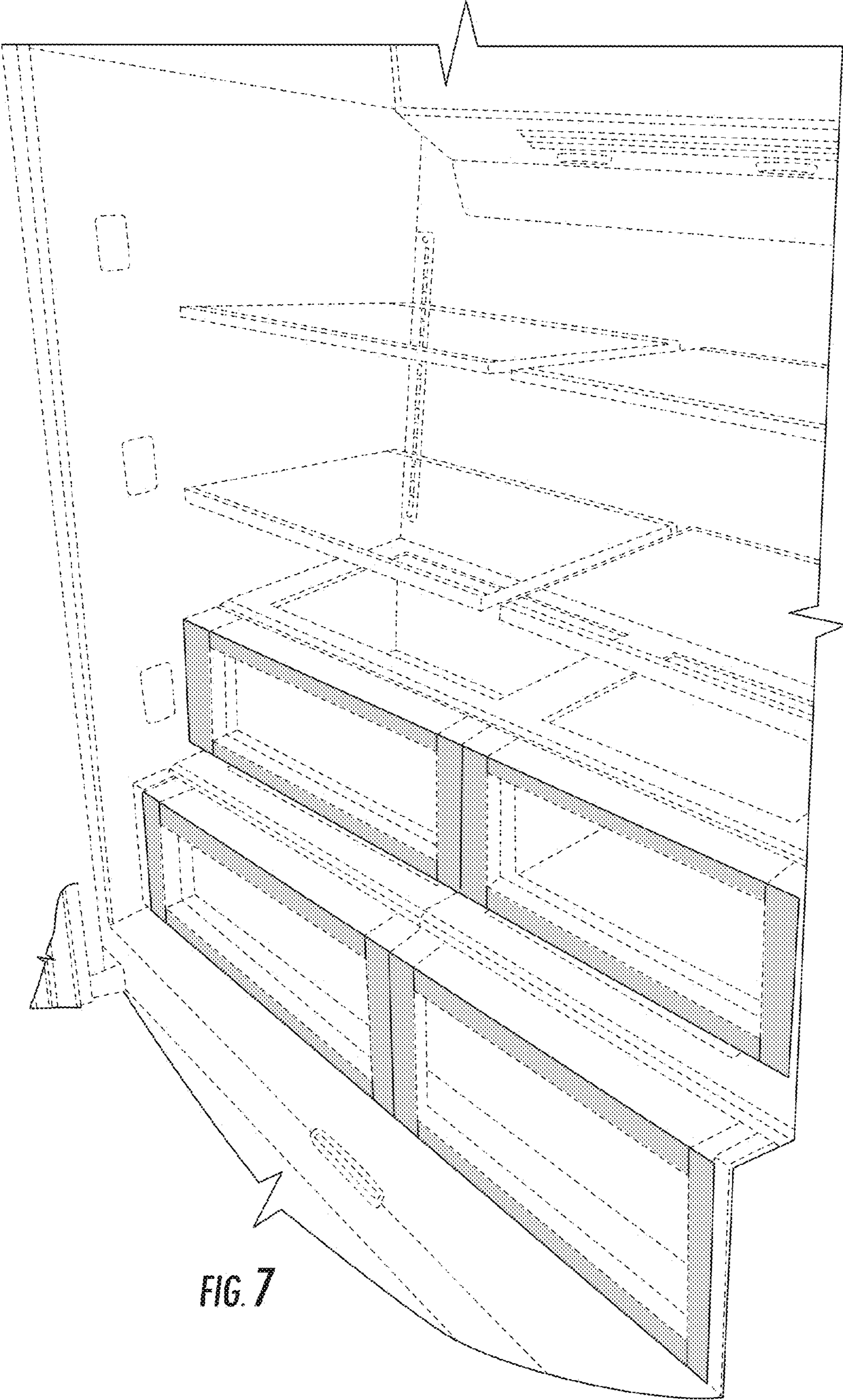
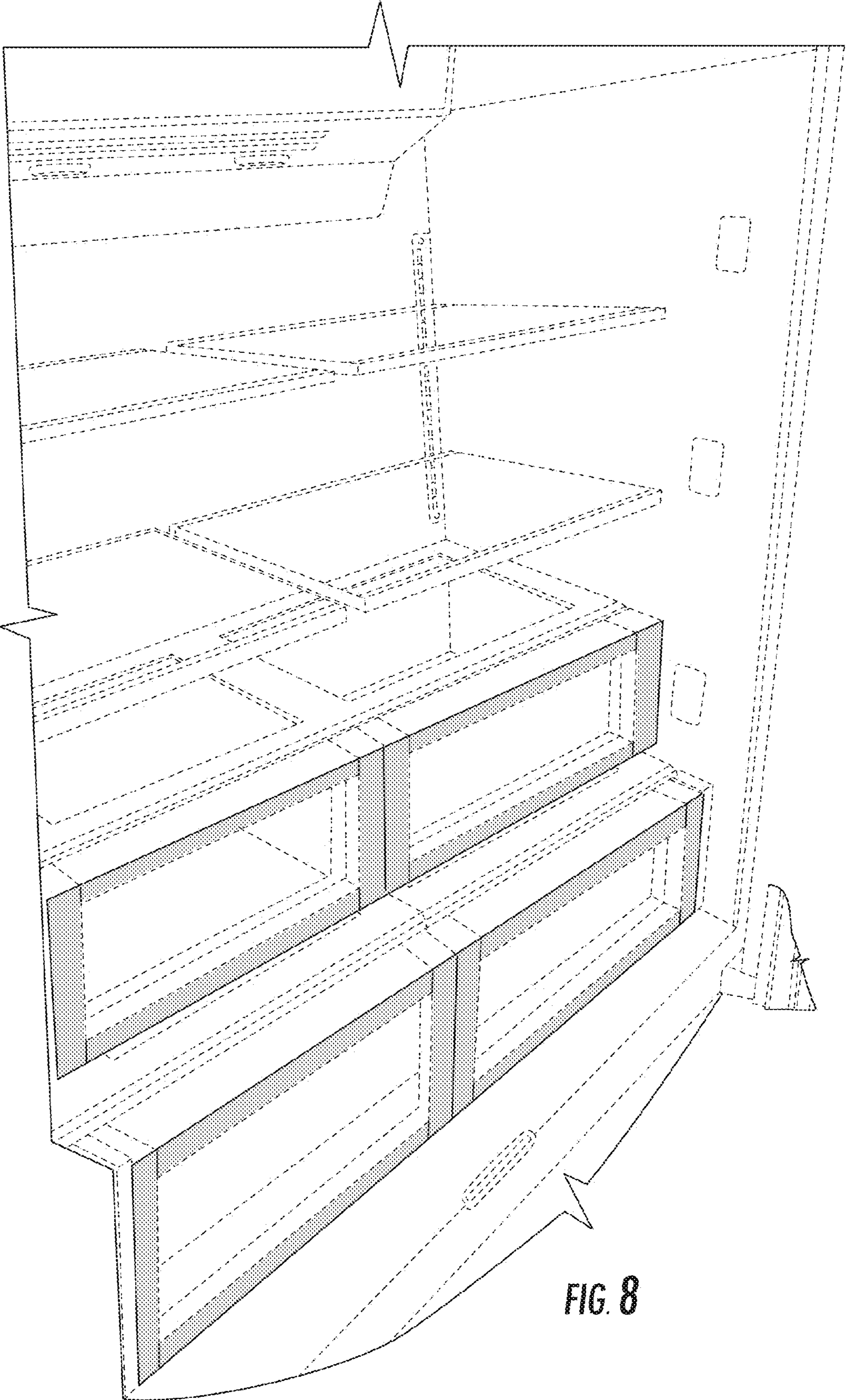

FIG. 7



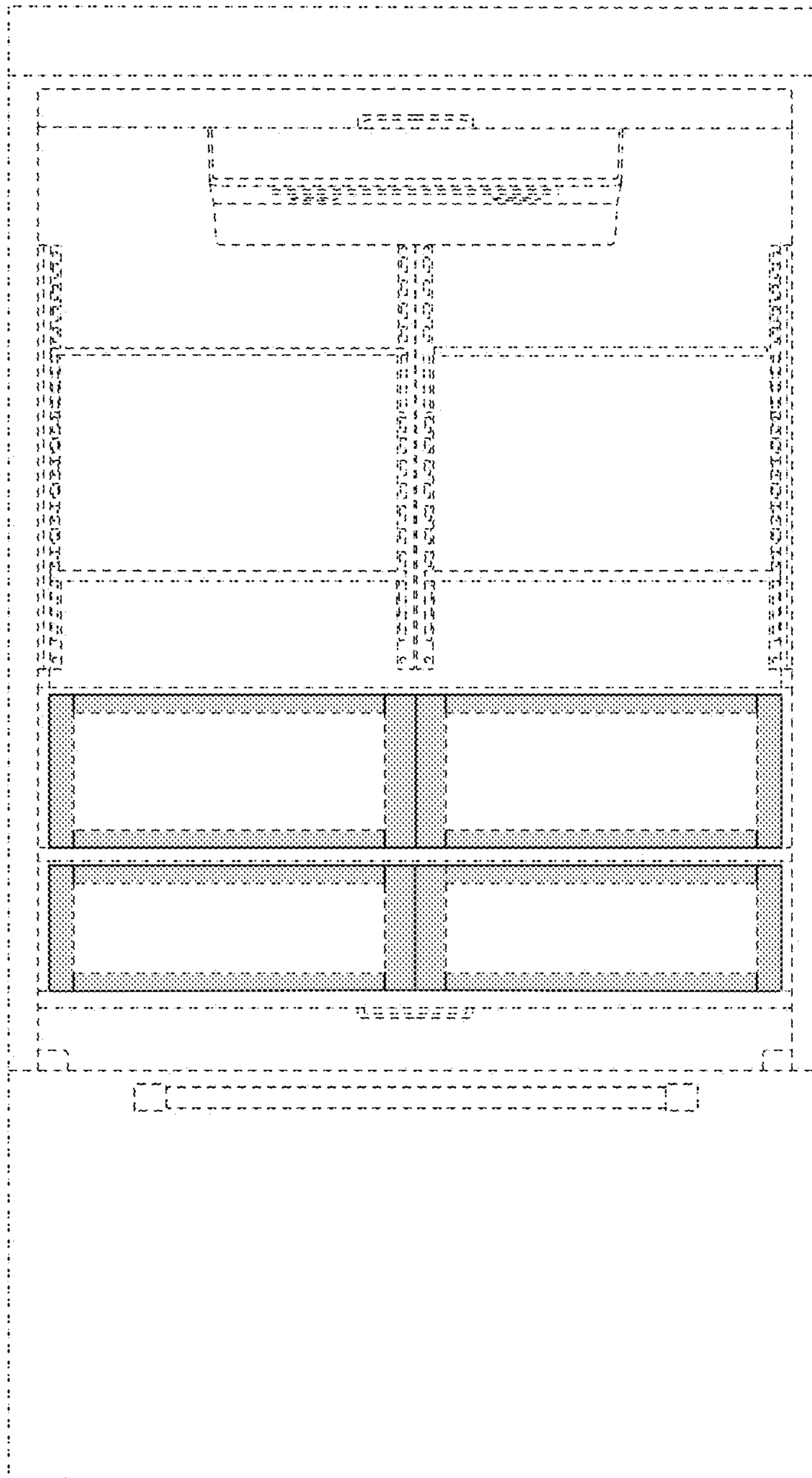

FIG. 9

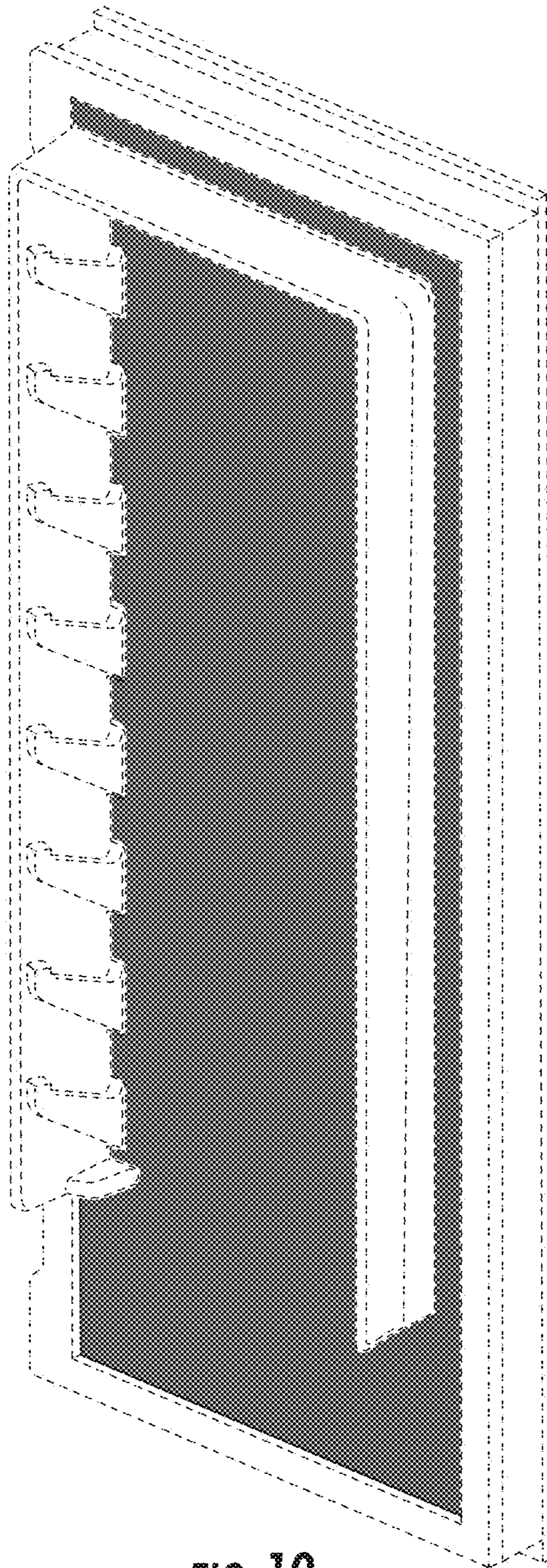

FIG. 10

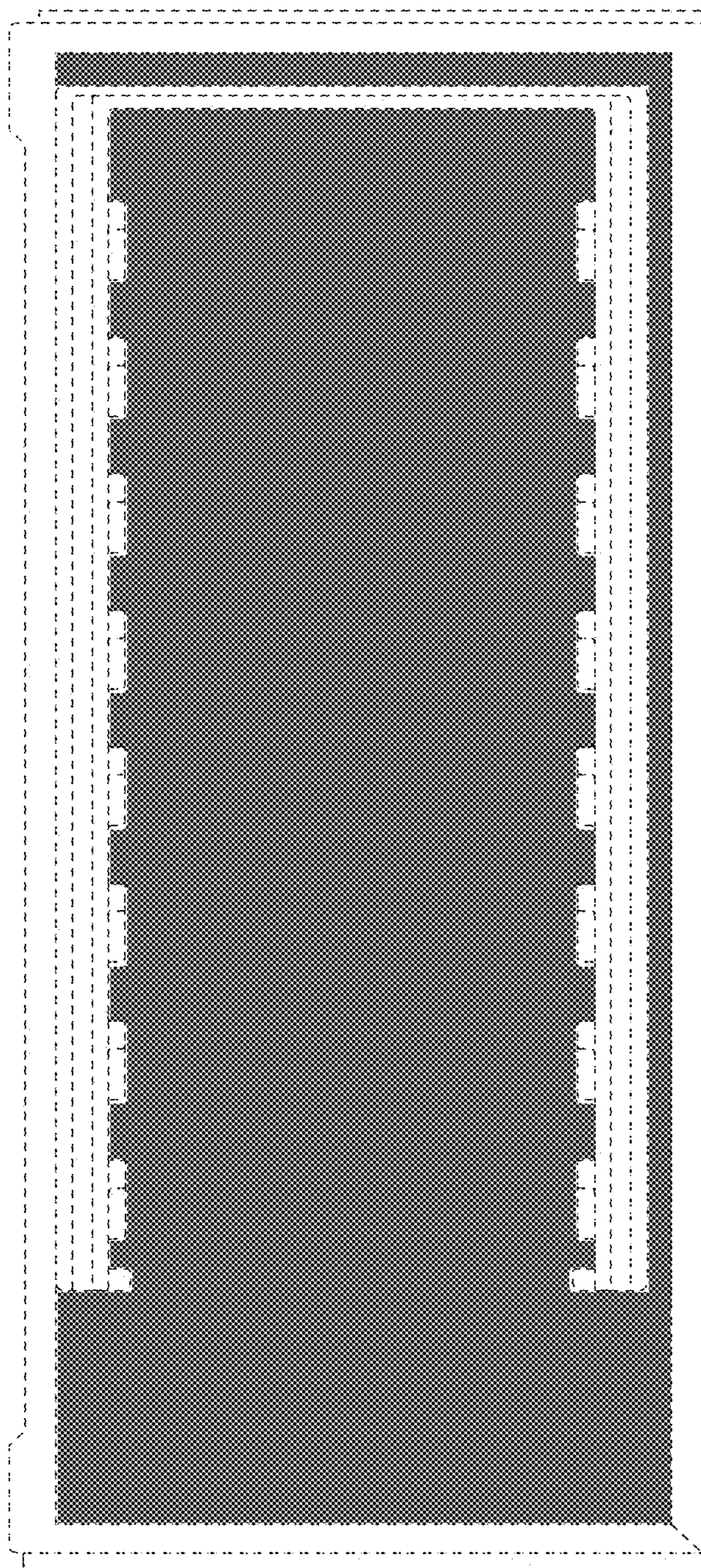

FIG. 11

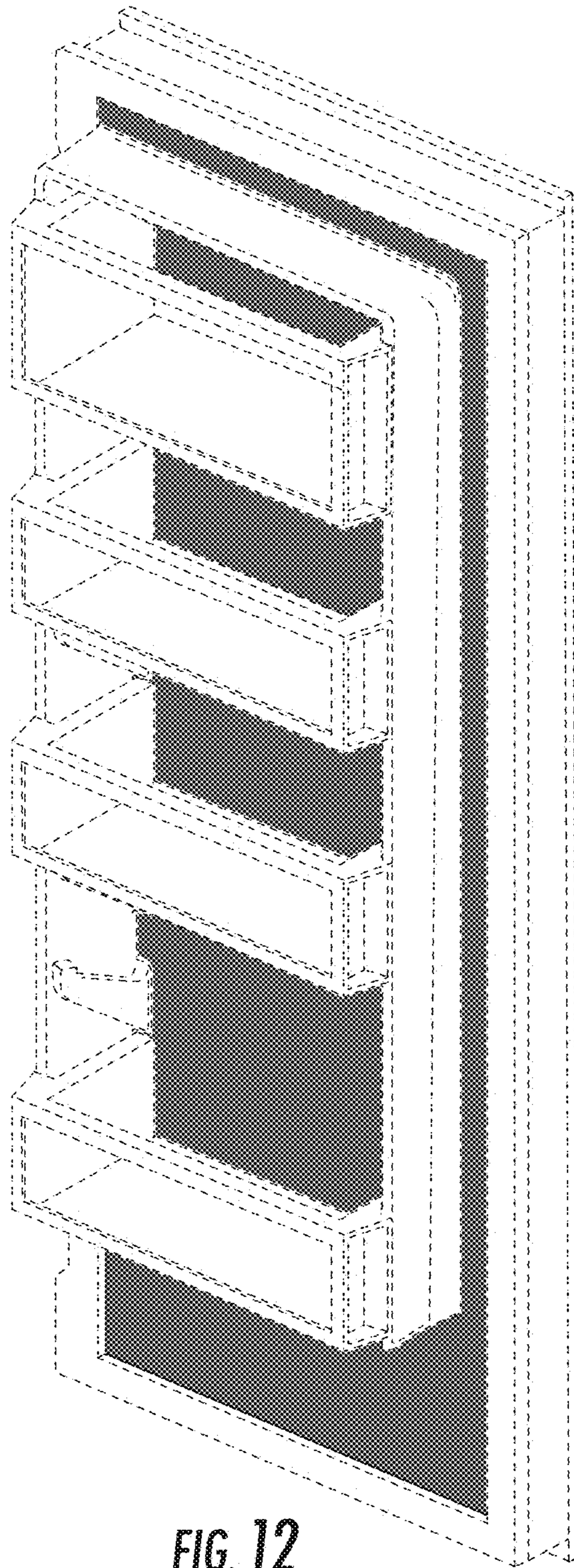

FIG. 12

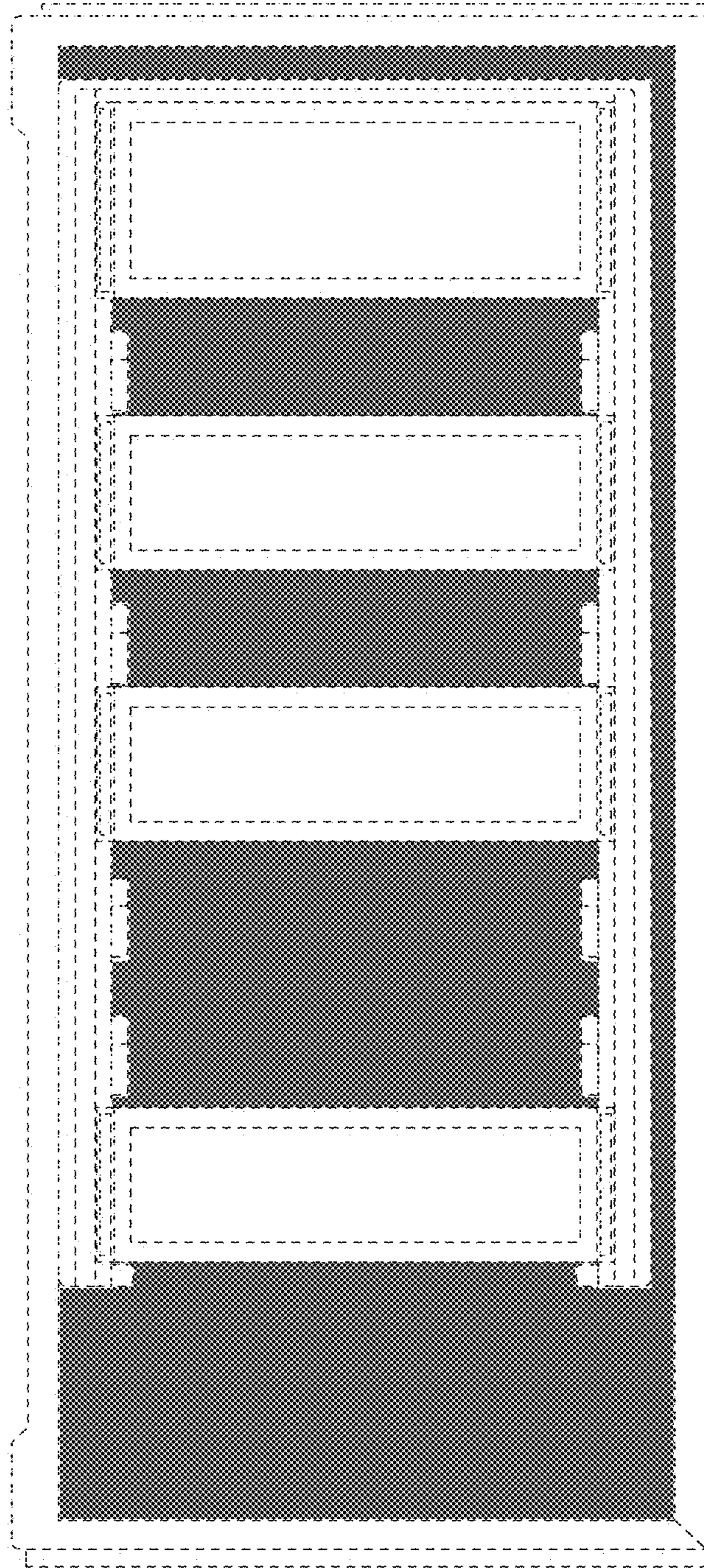

FIG. 13

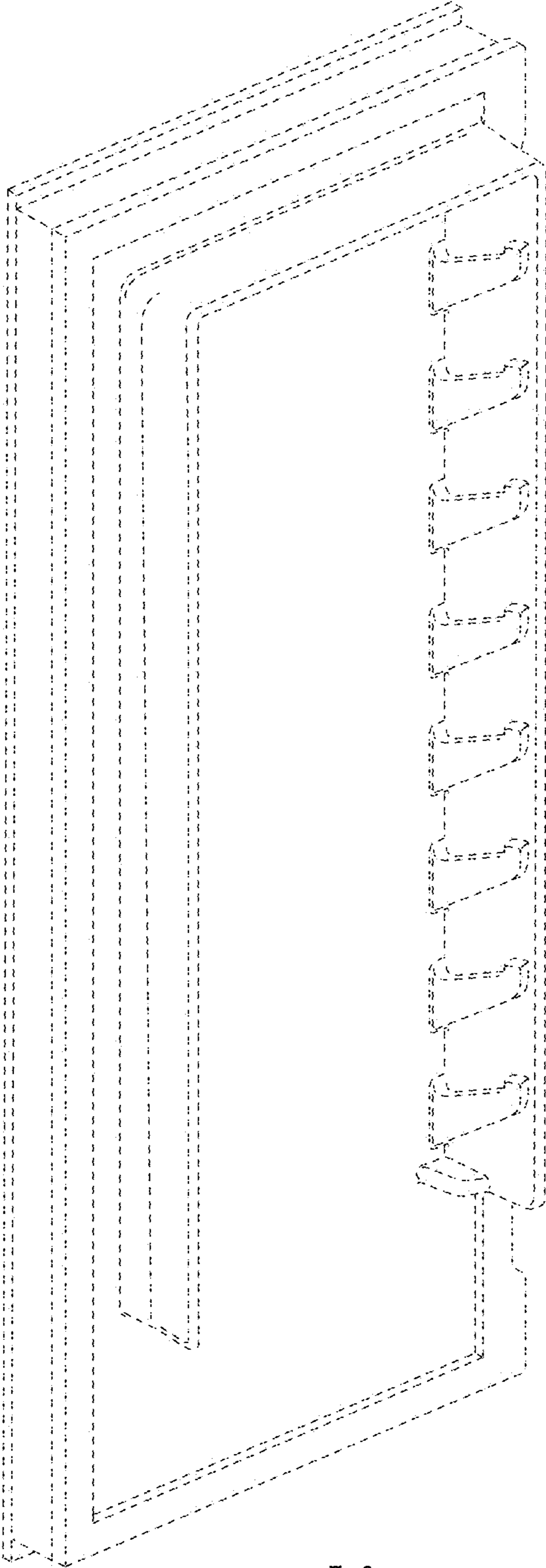

FIG. 14

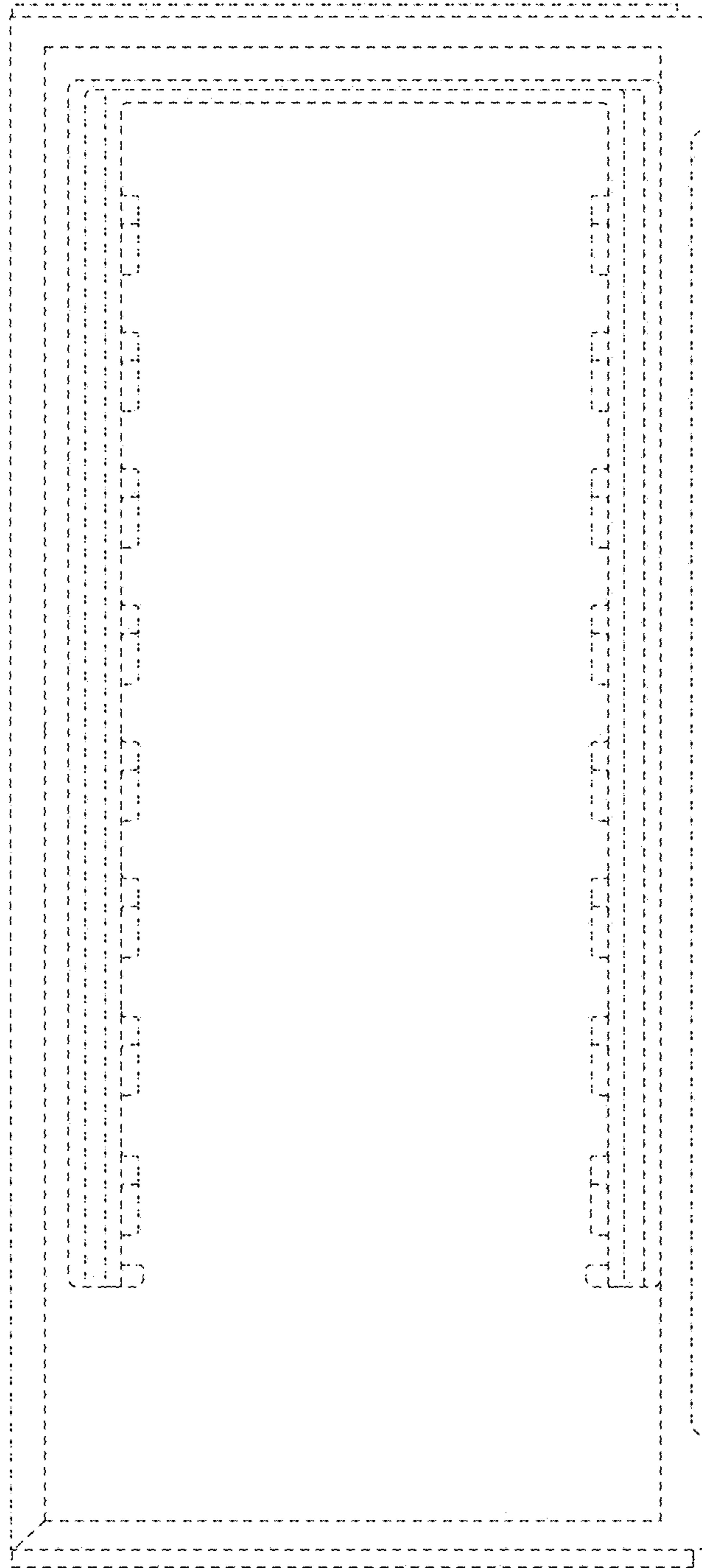

FIG. 15

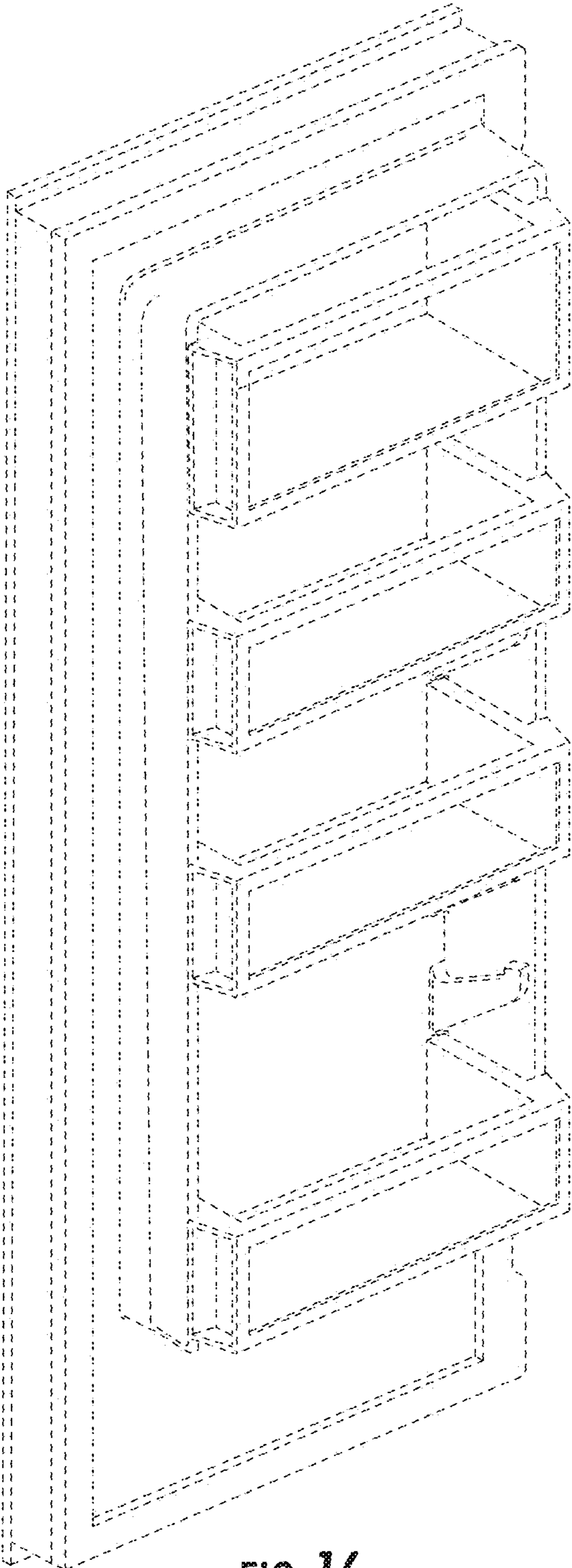

FIG. 16

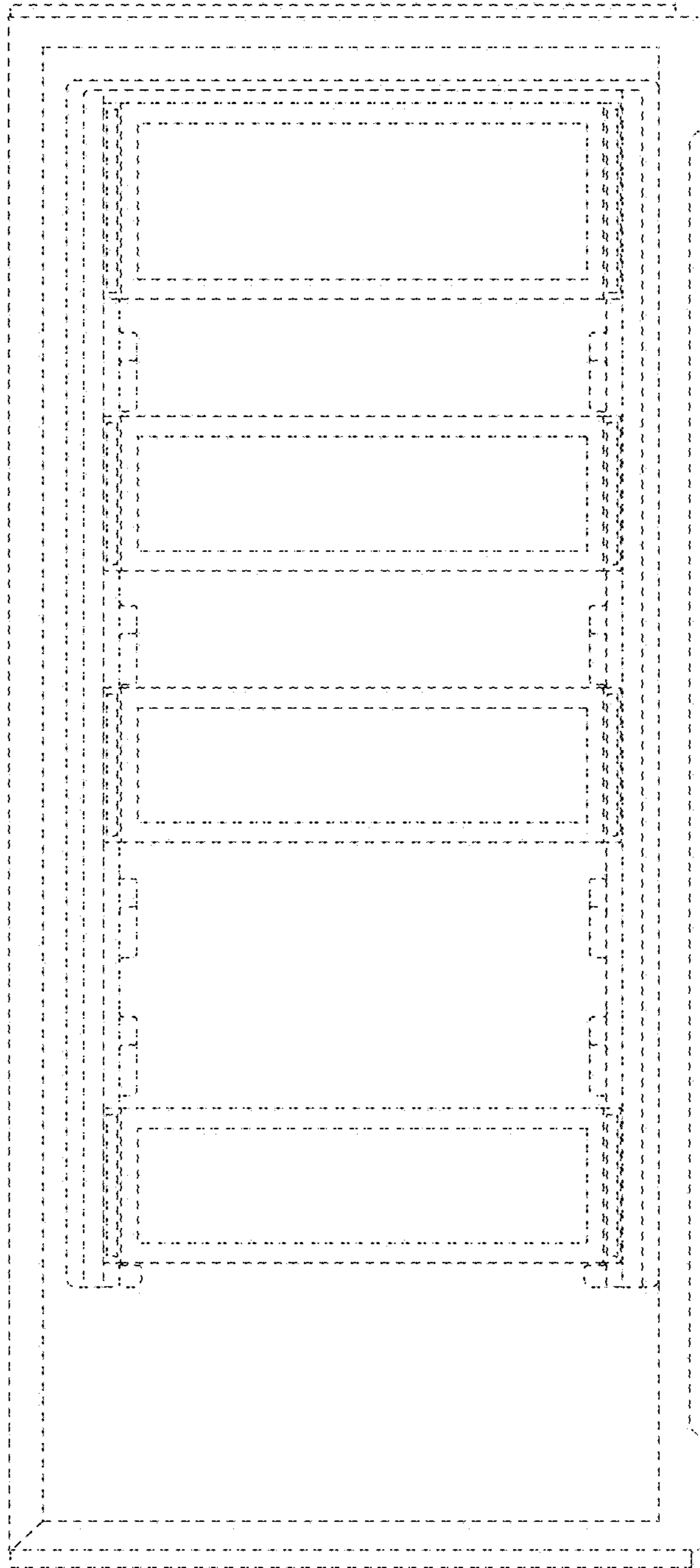

FIG. 17

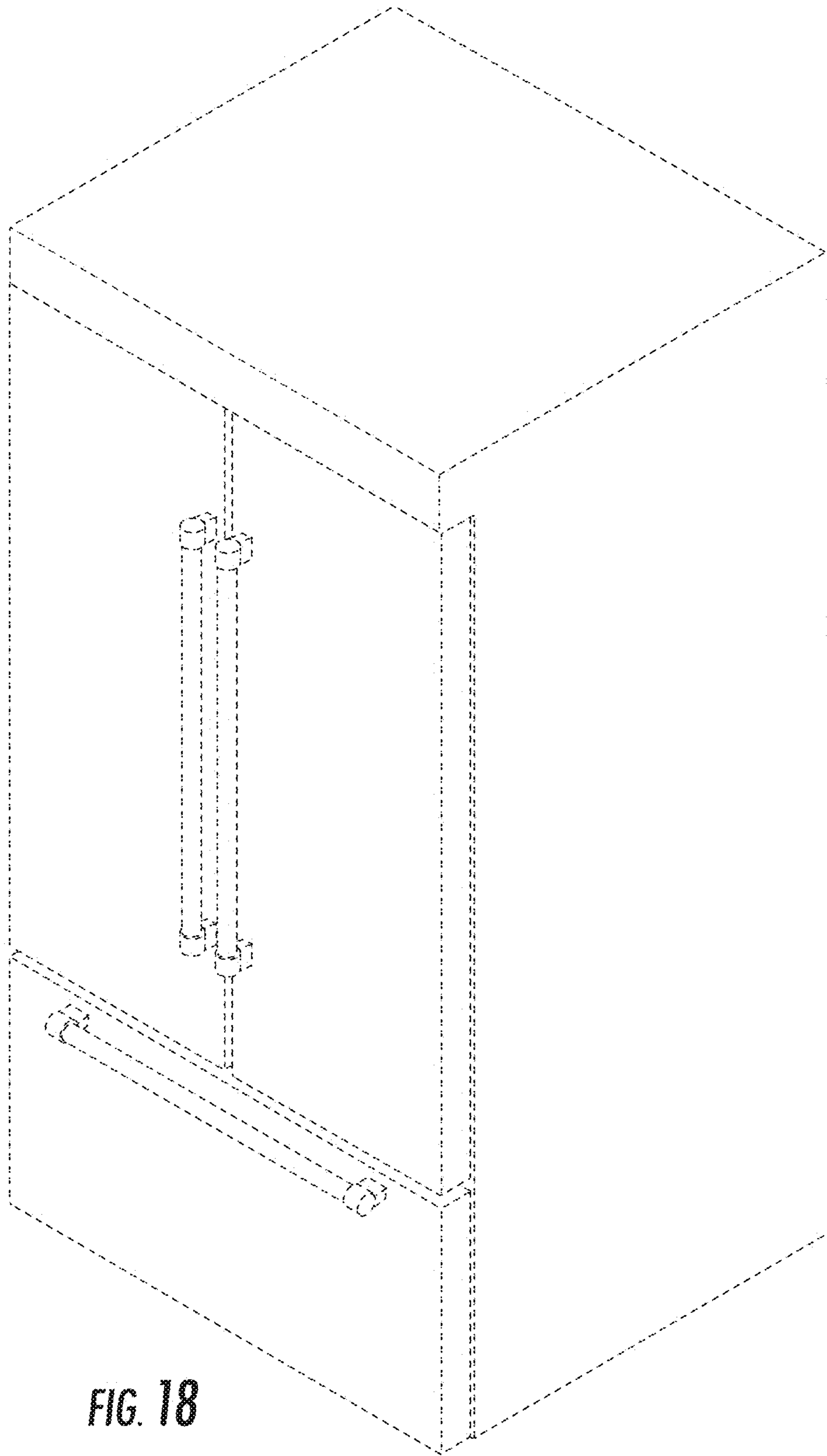

FIG. 18

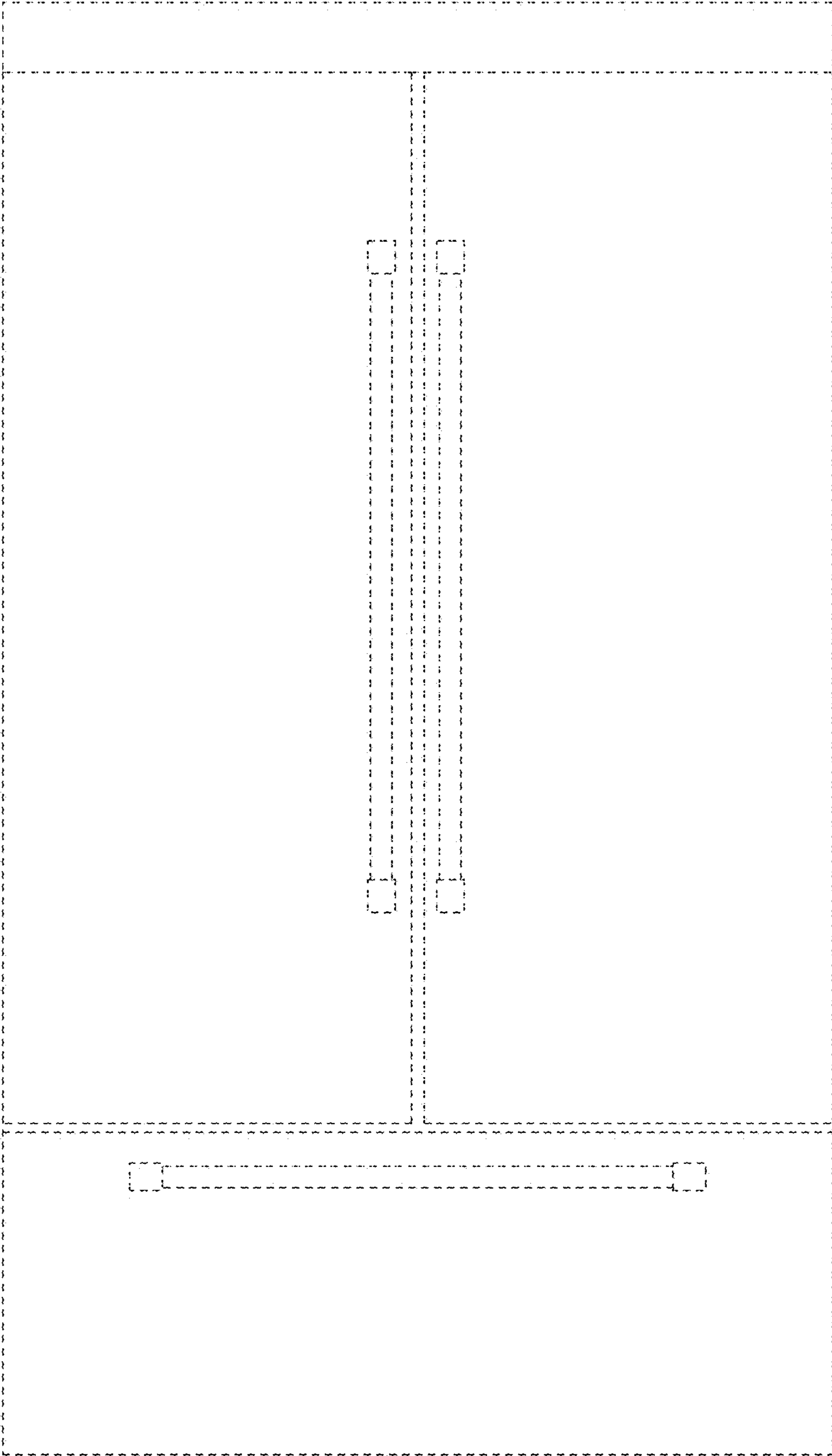

FIG. 19

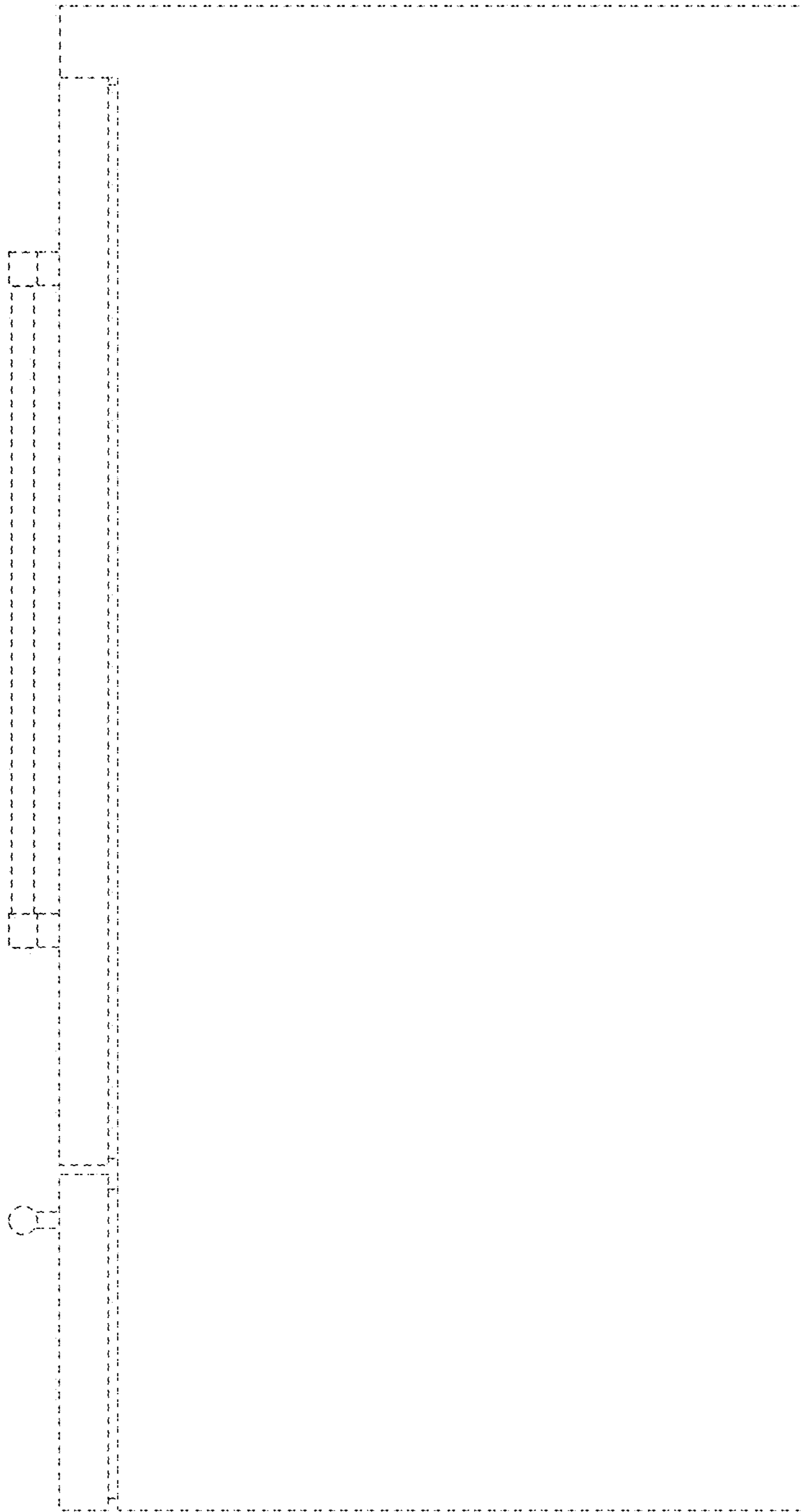

FIG. 20



FIG. 21

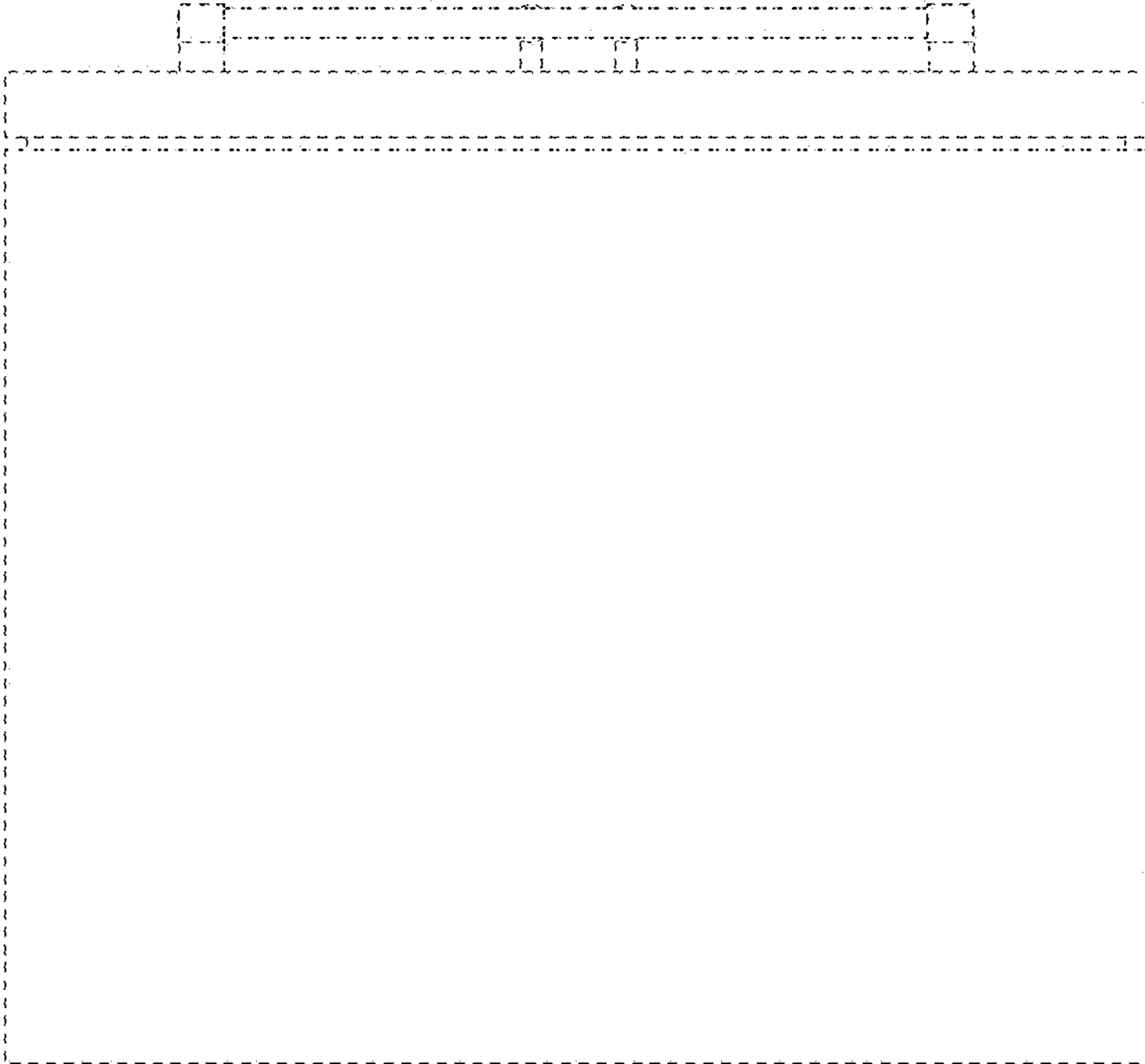

FIG. 22

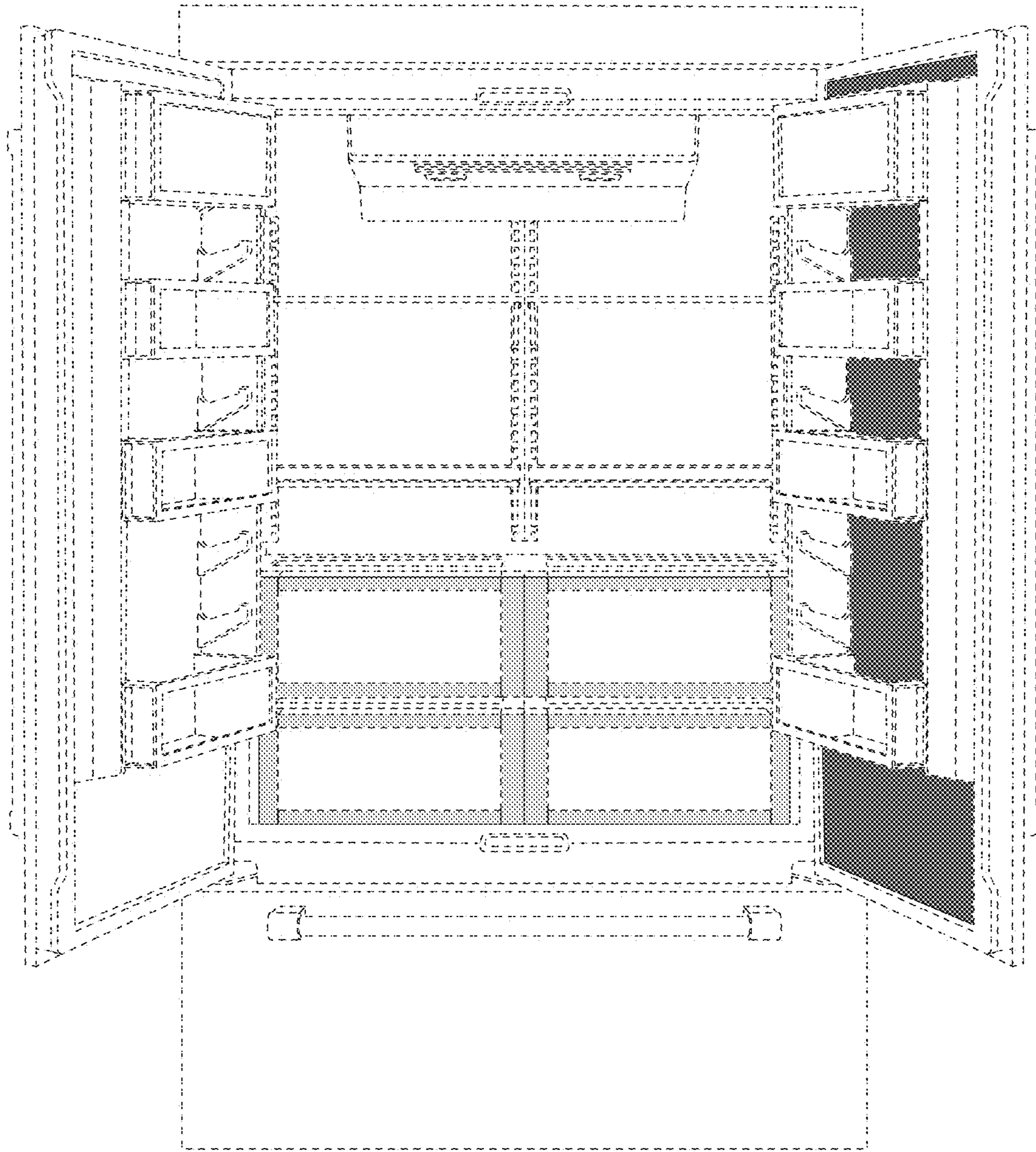
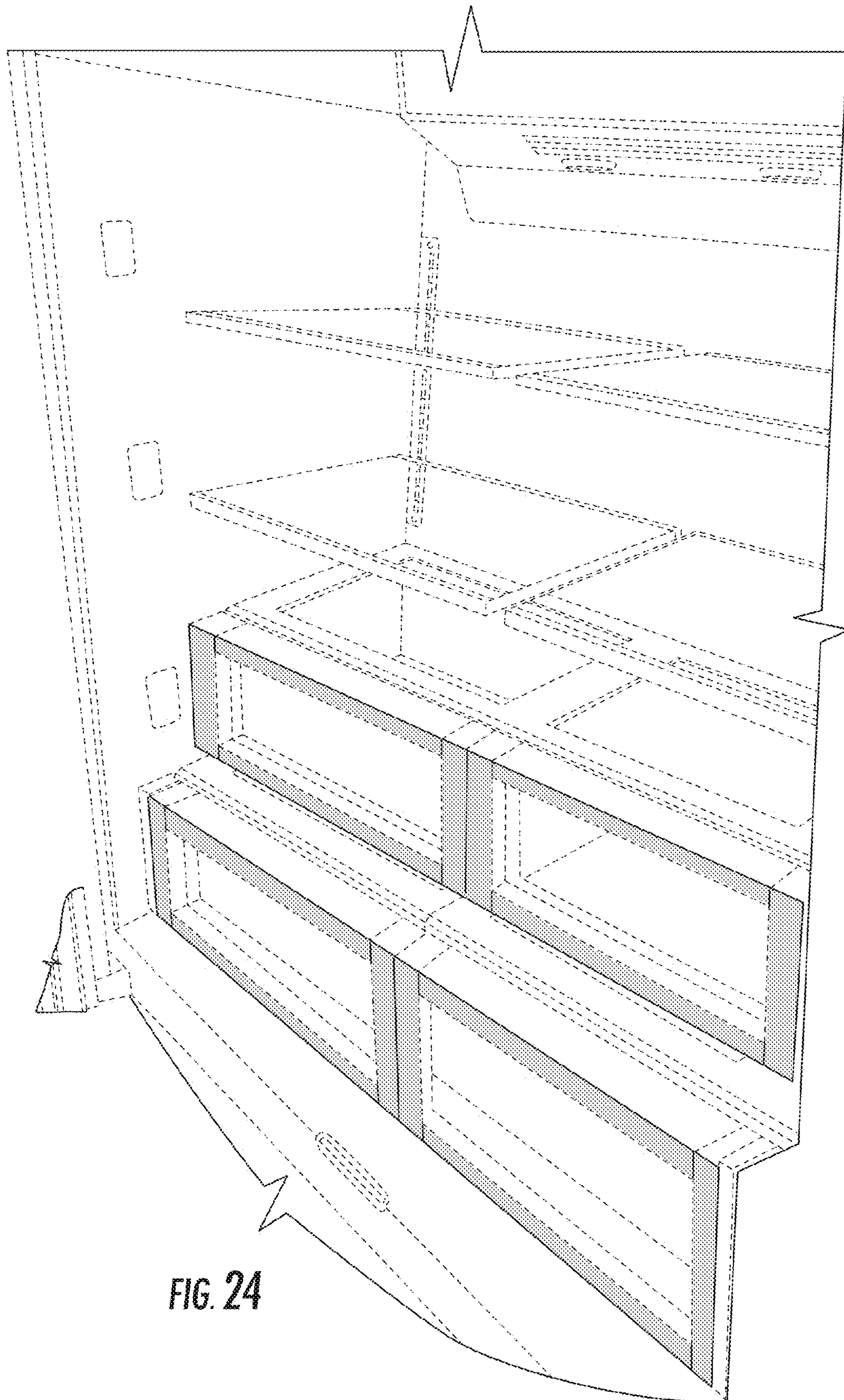
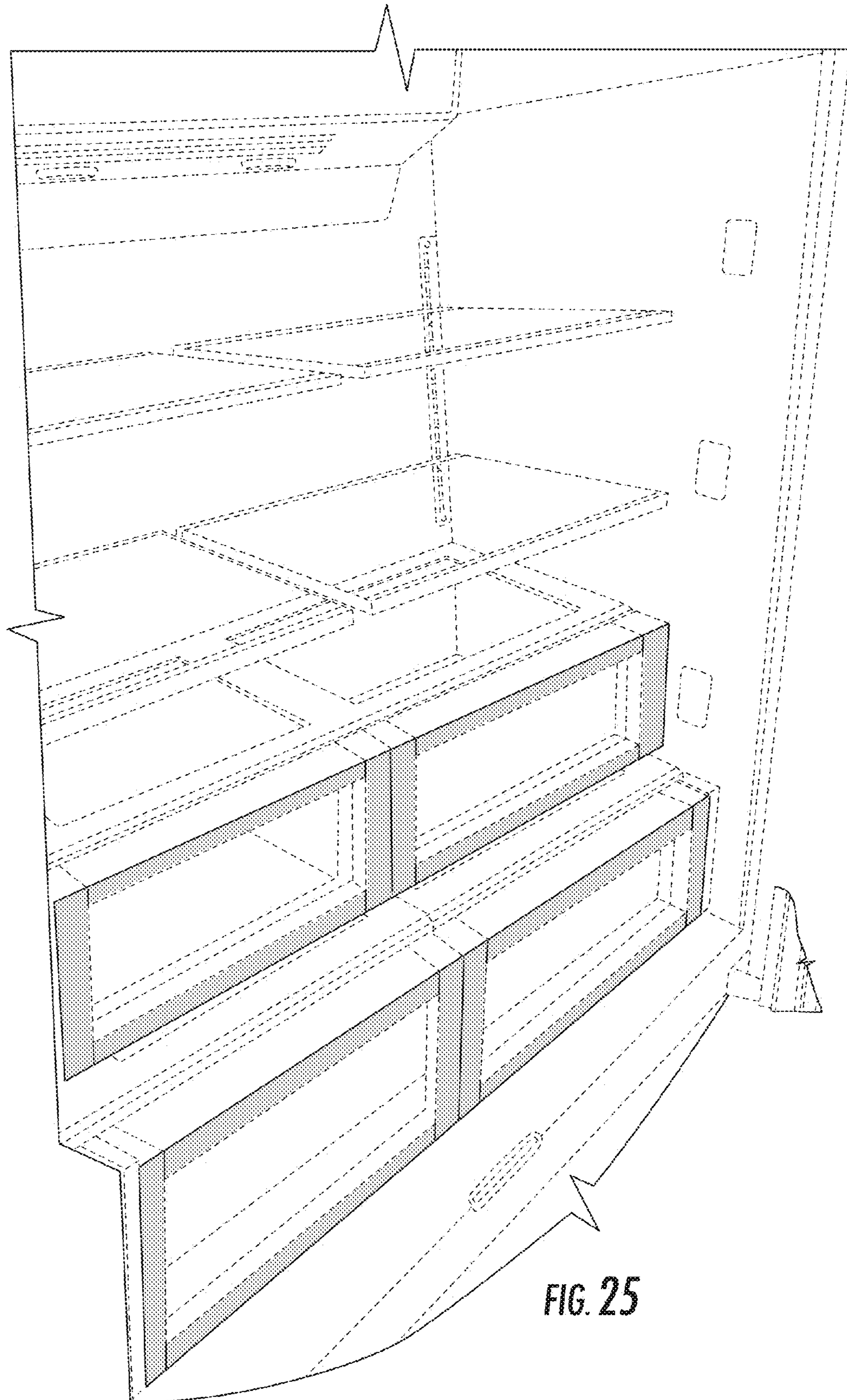

FIG. 23





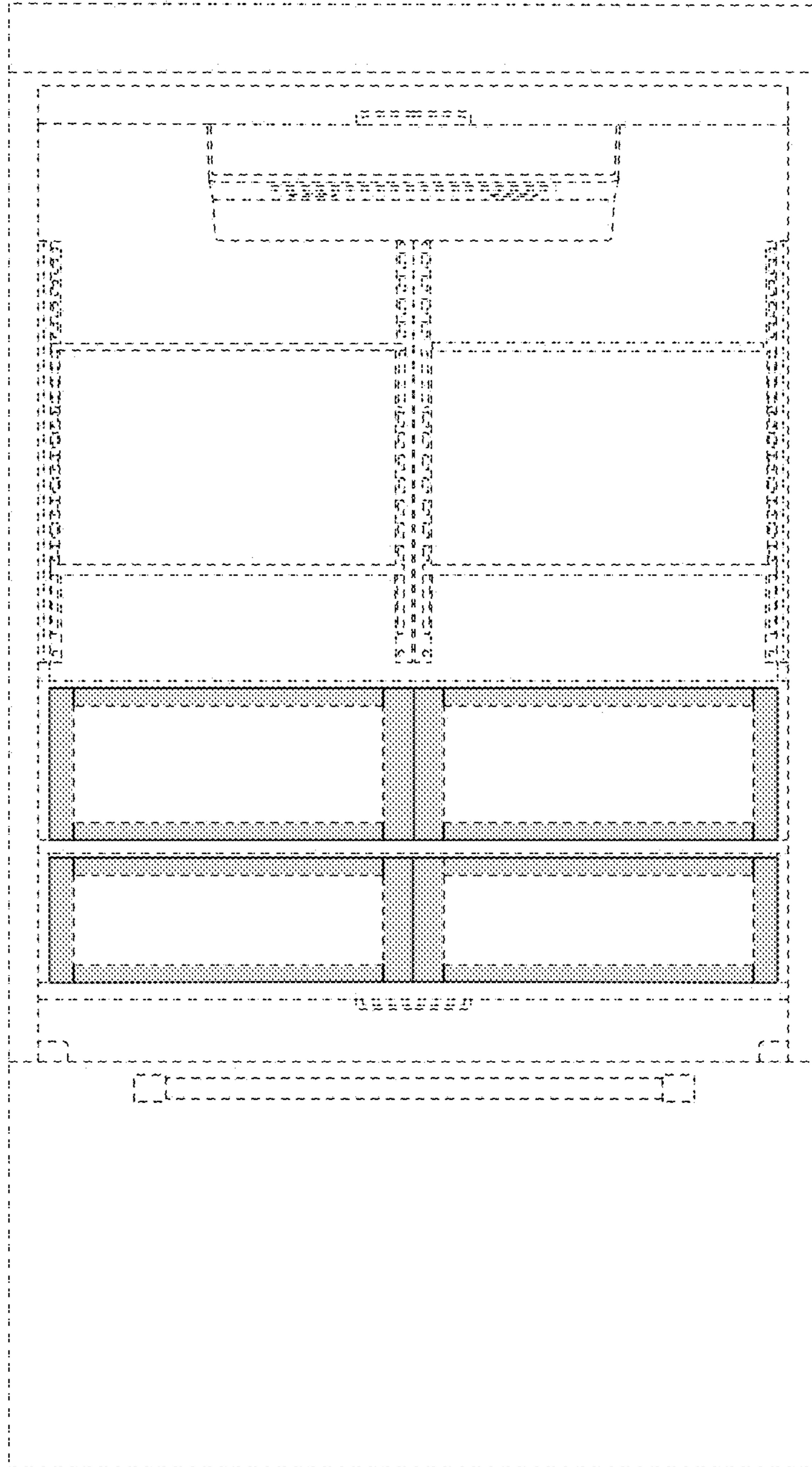

FIG. 26

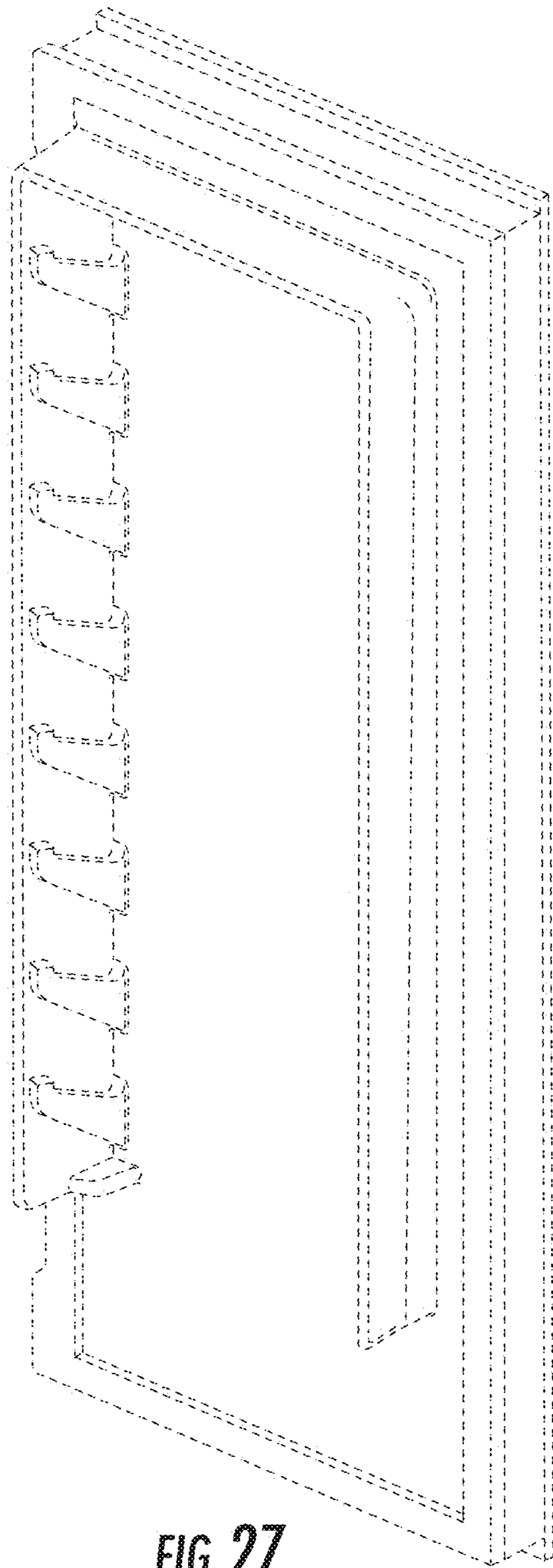

FIG. 27

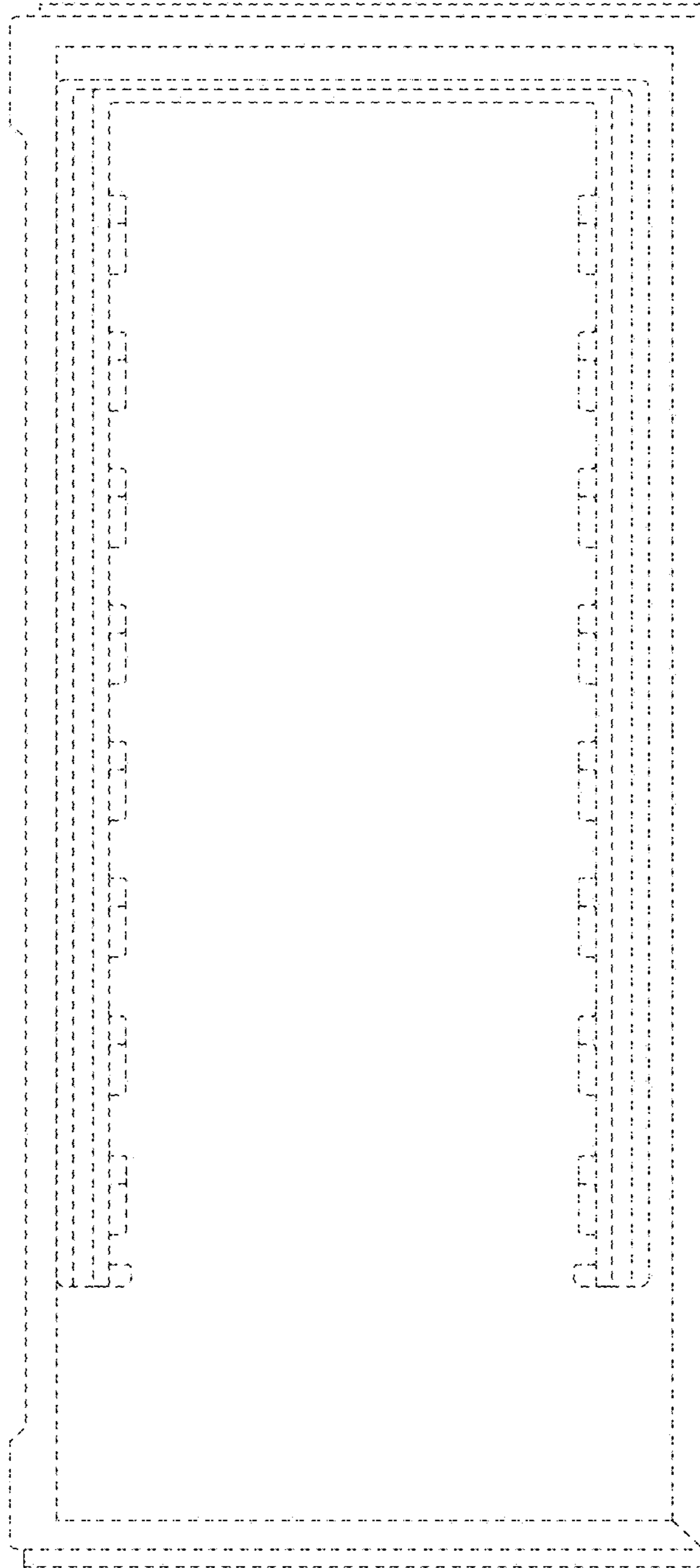

FIG. 28

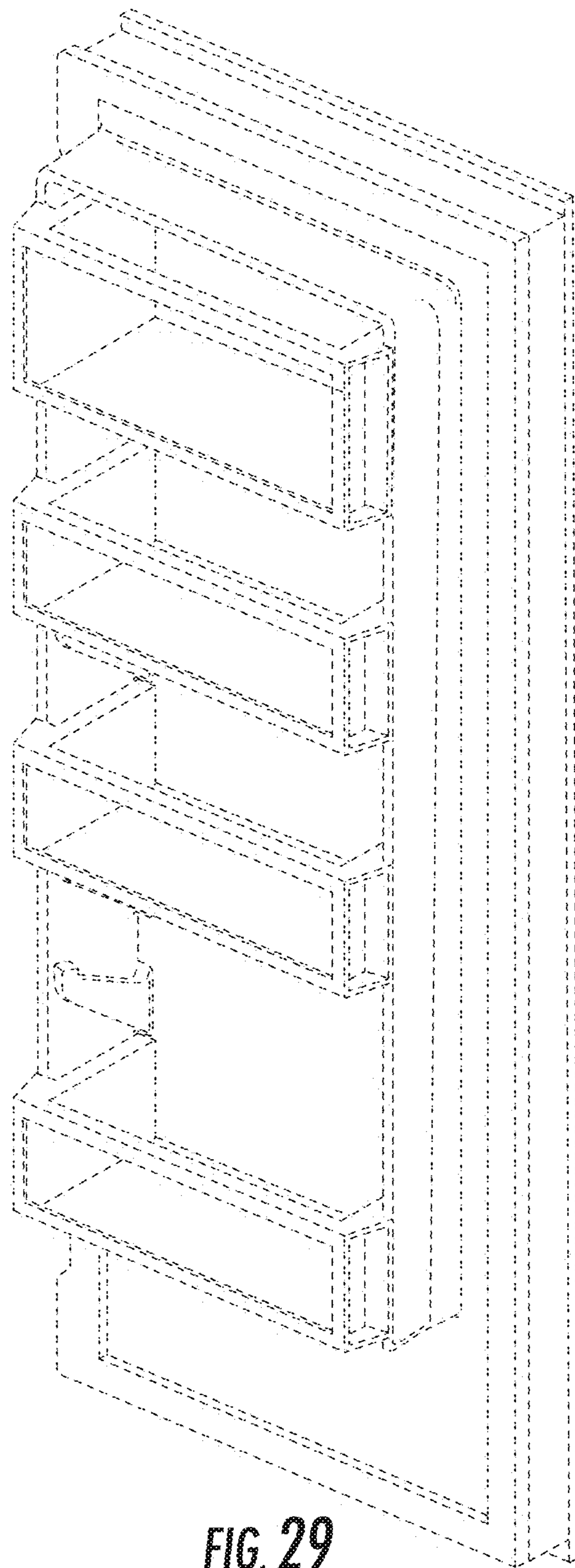

FIG. 29

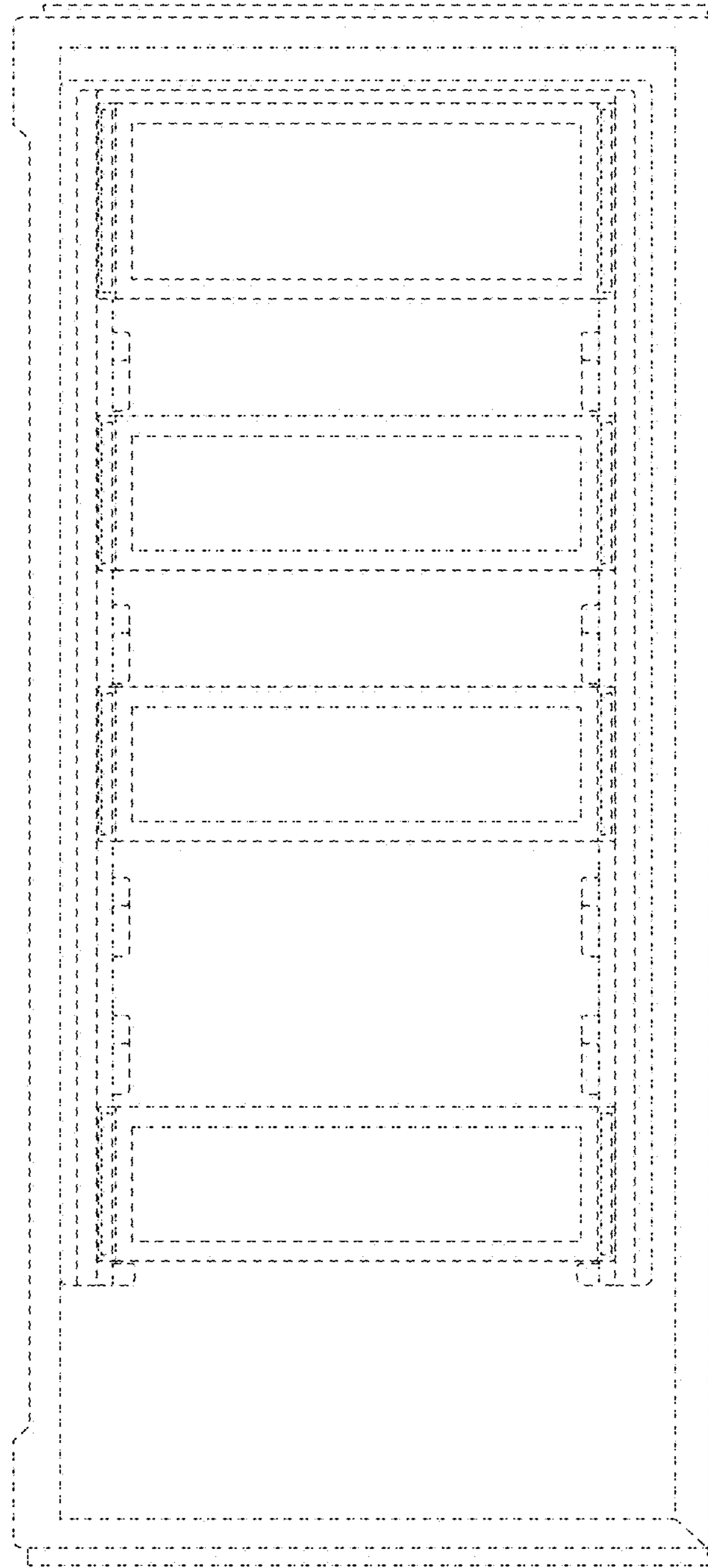

FIG. 30

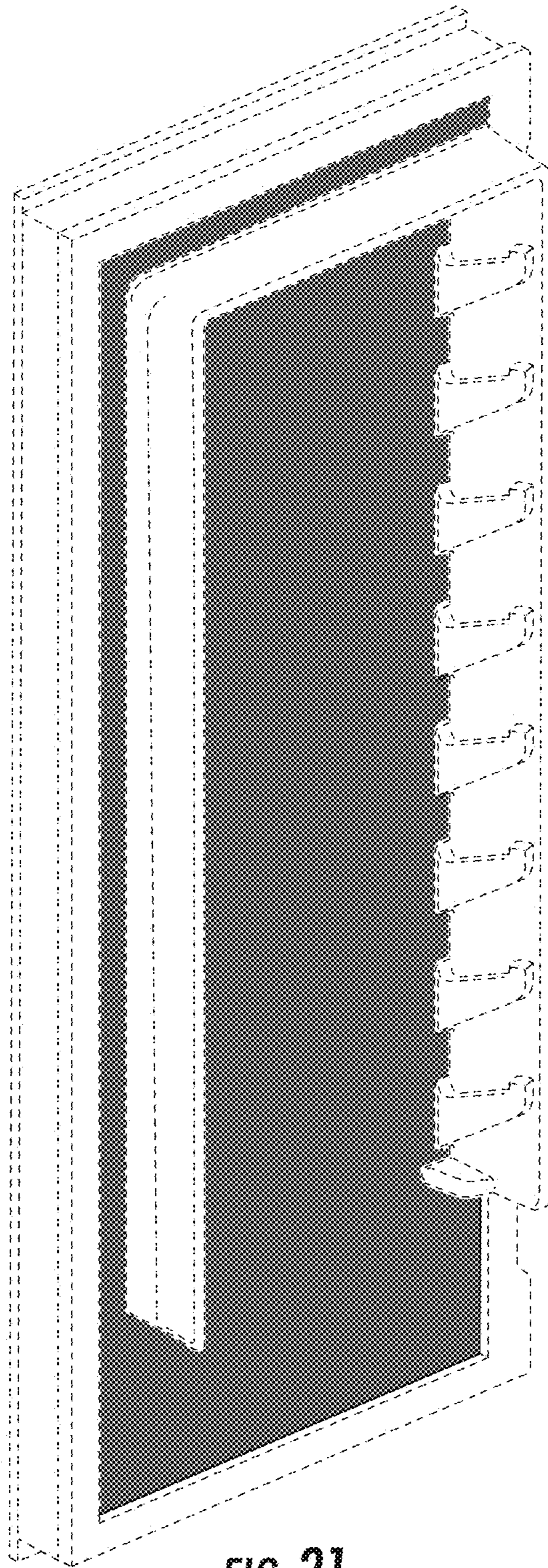

FIG. 31

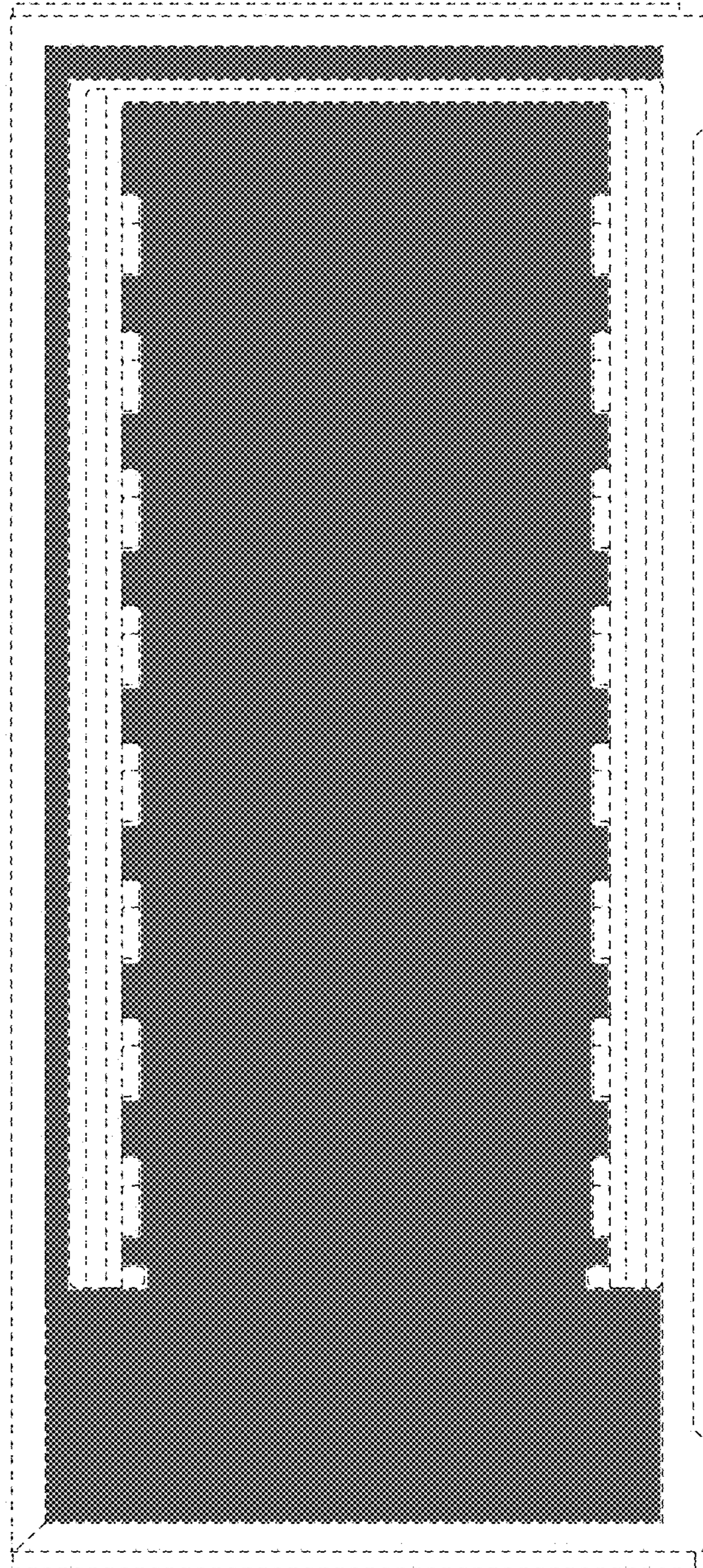

FIG. 32

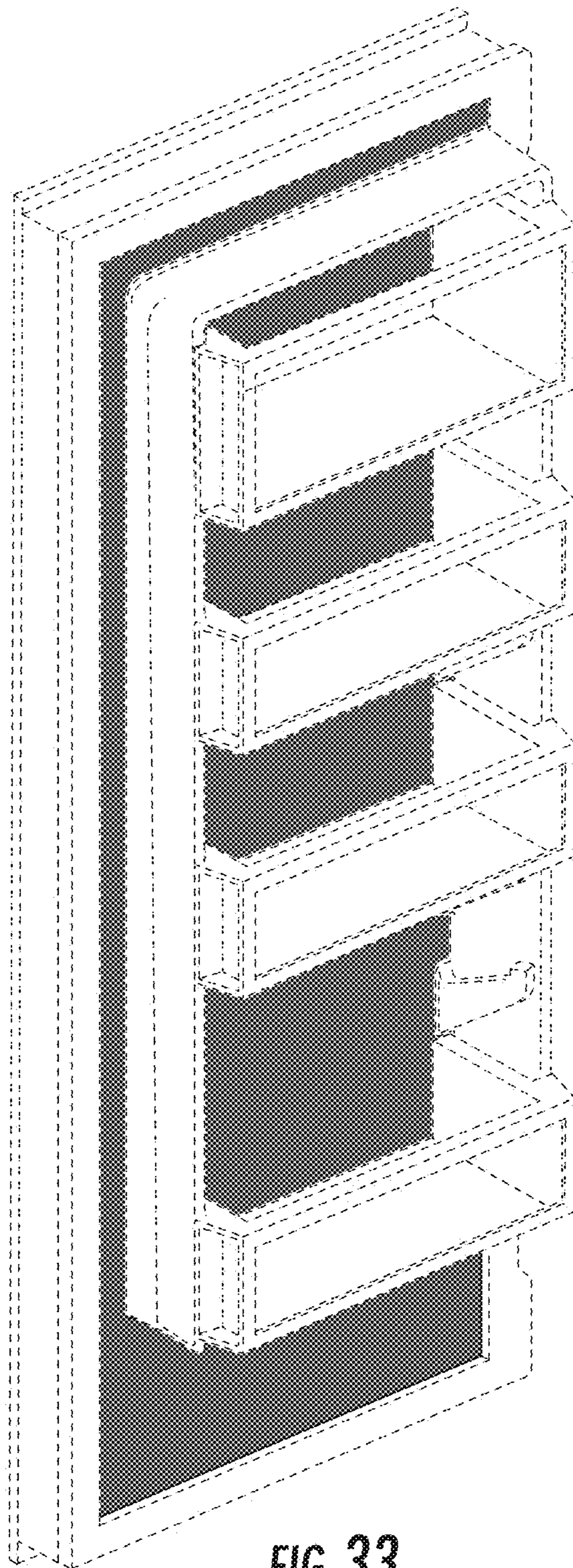

FIG. 33

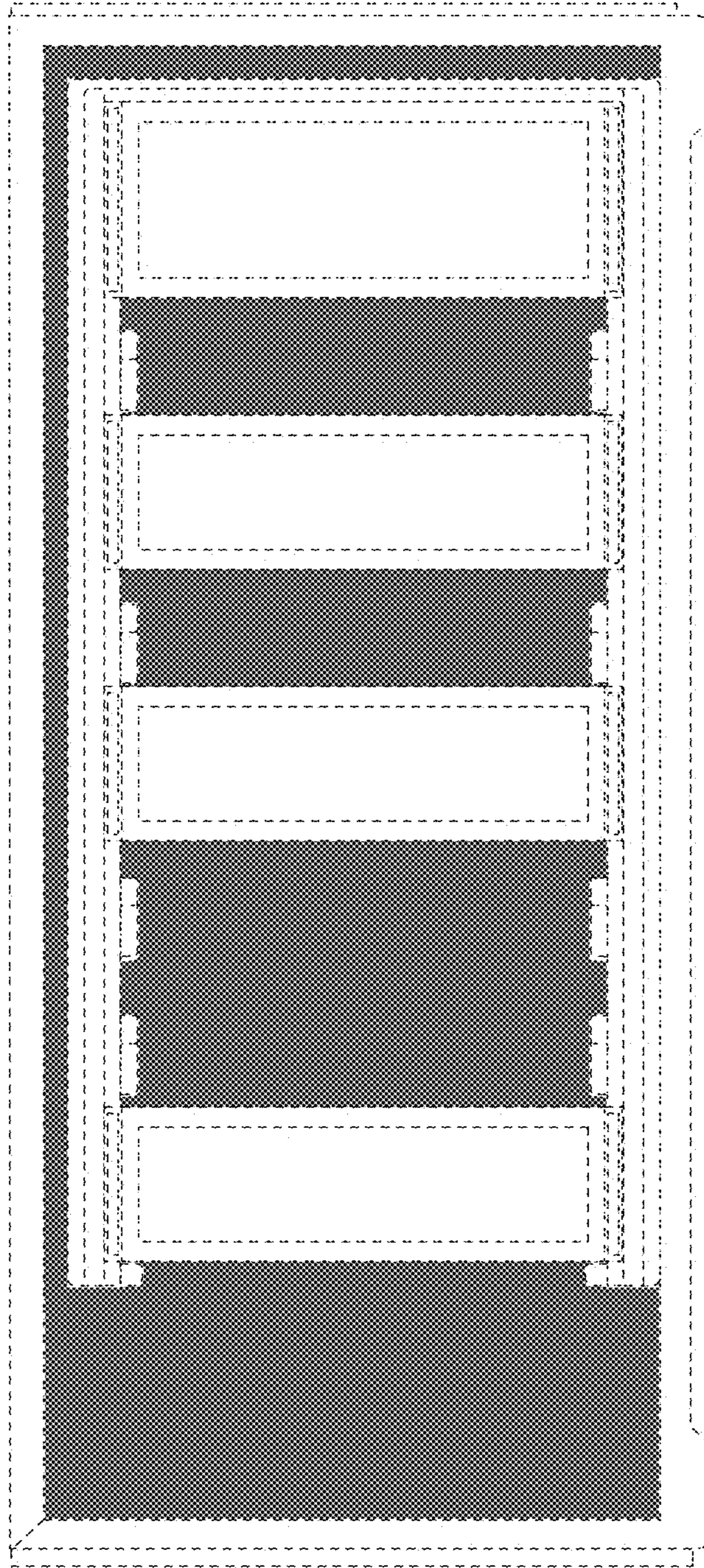

FIG. 34

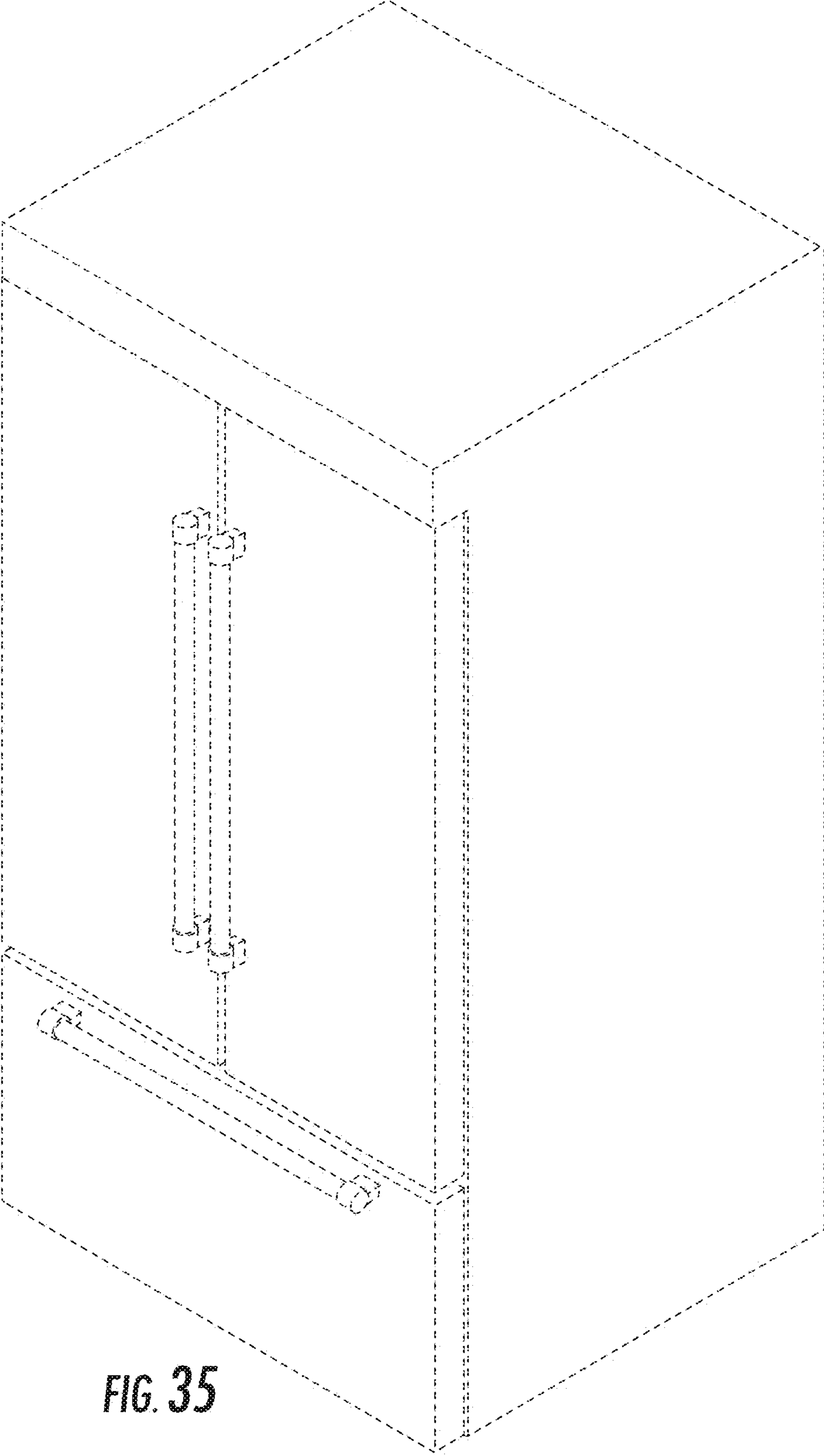

FIG. 35

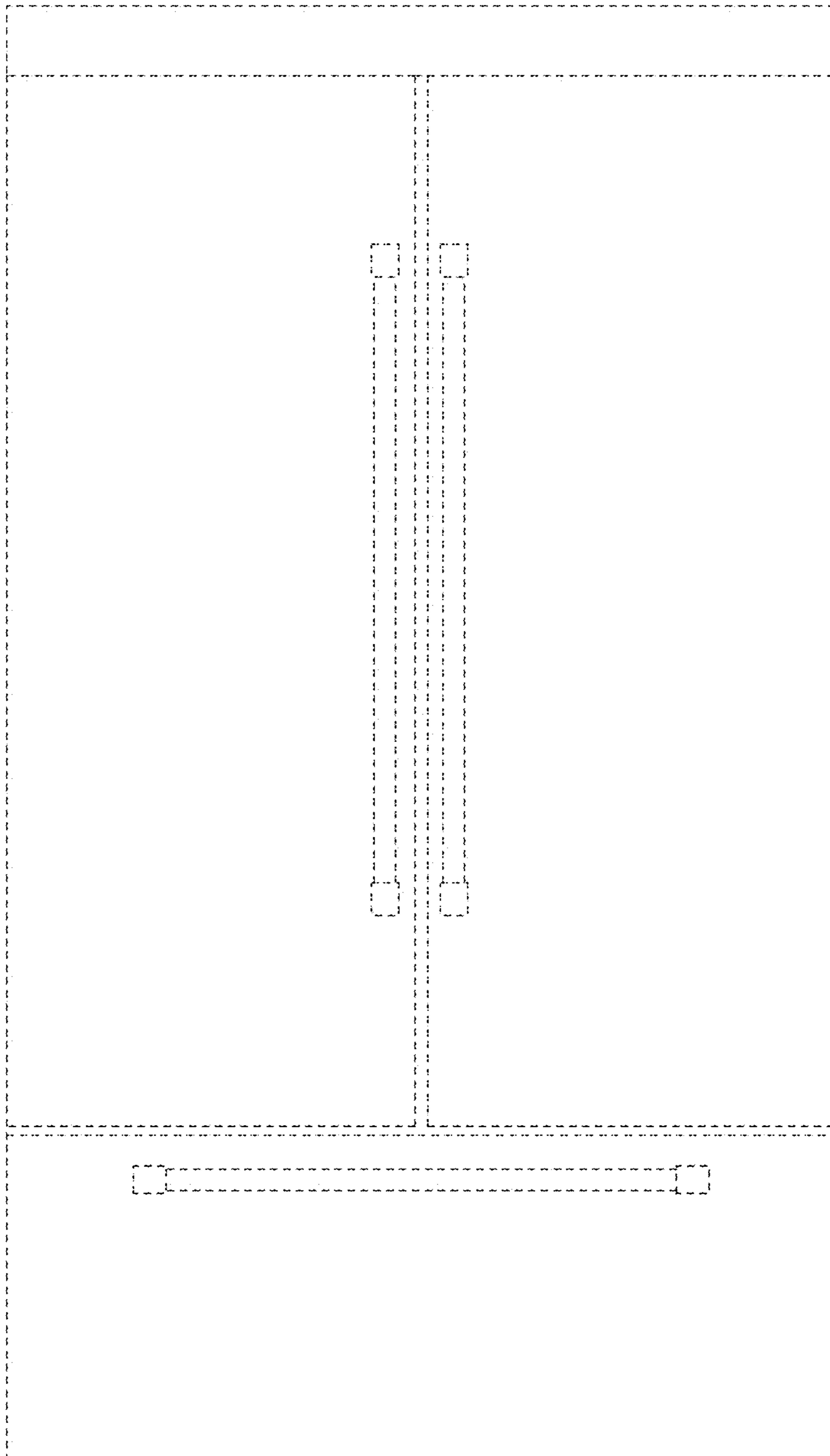

FIG. 36

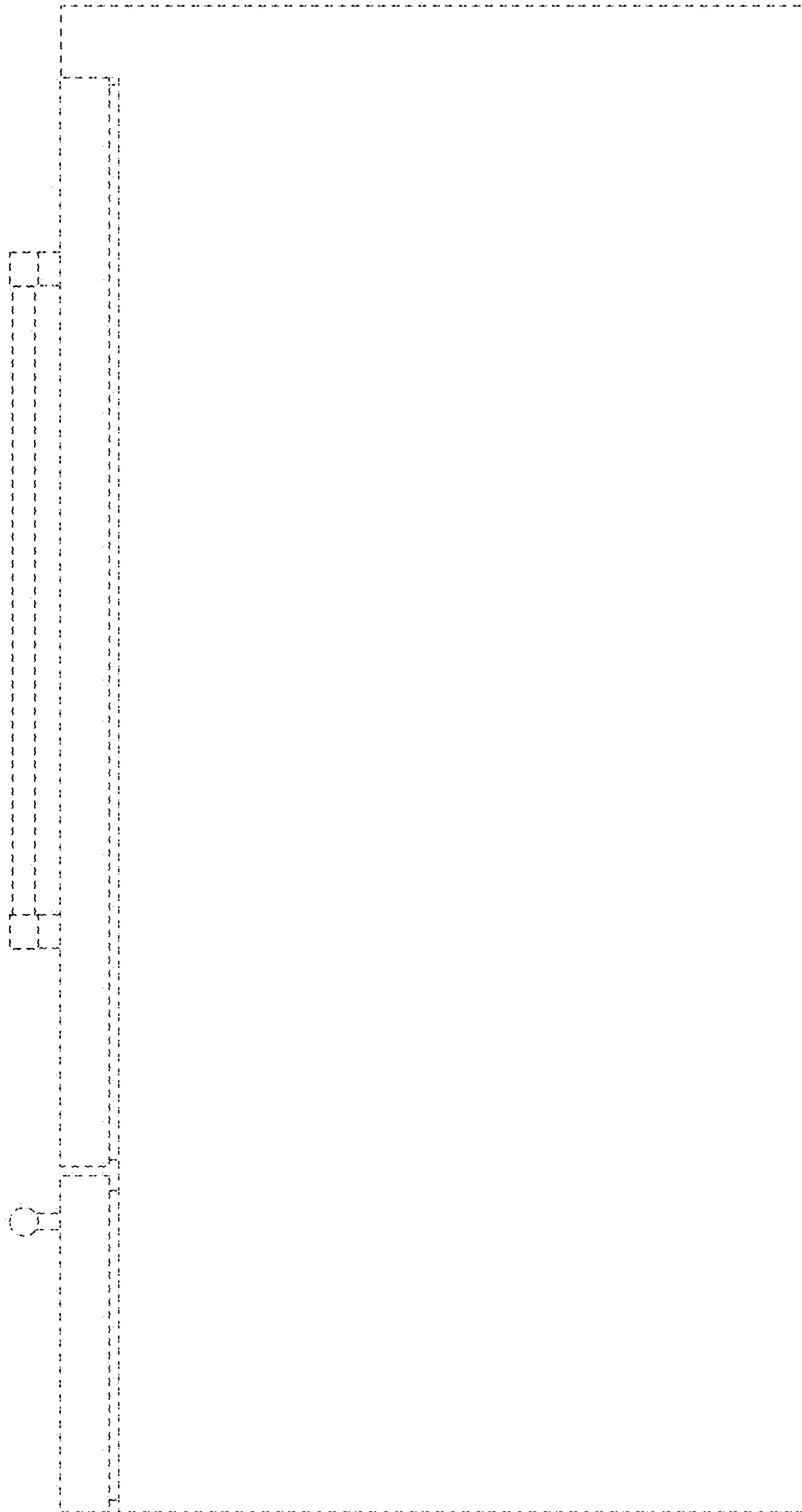

FIG. 37

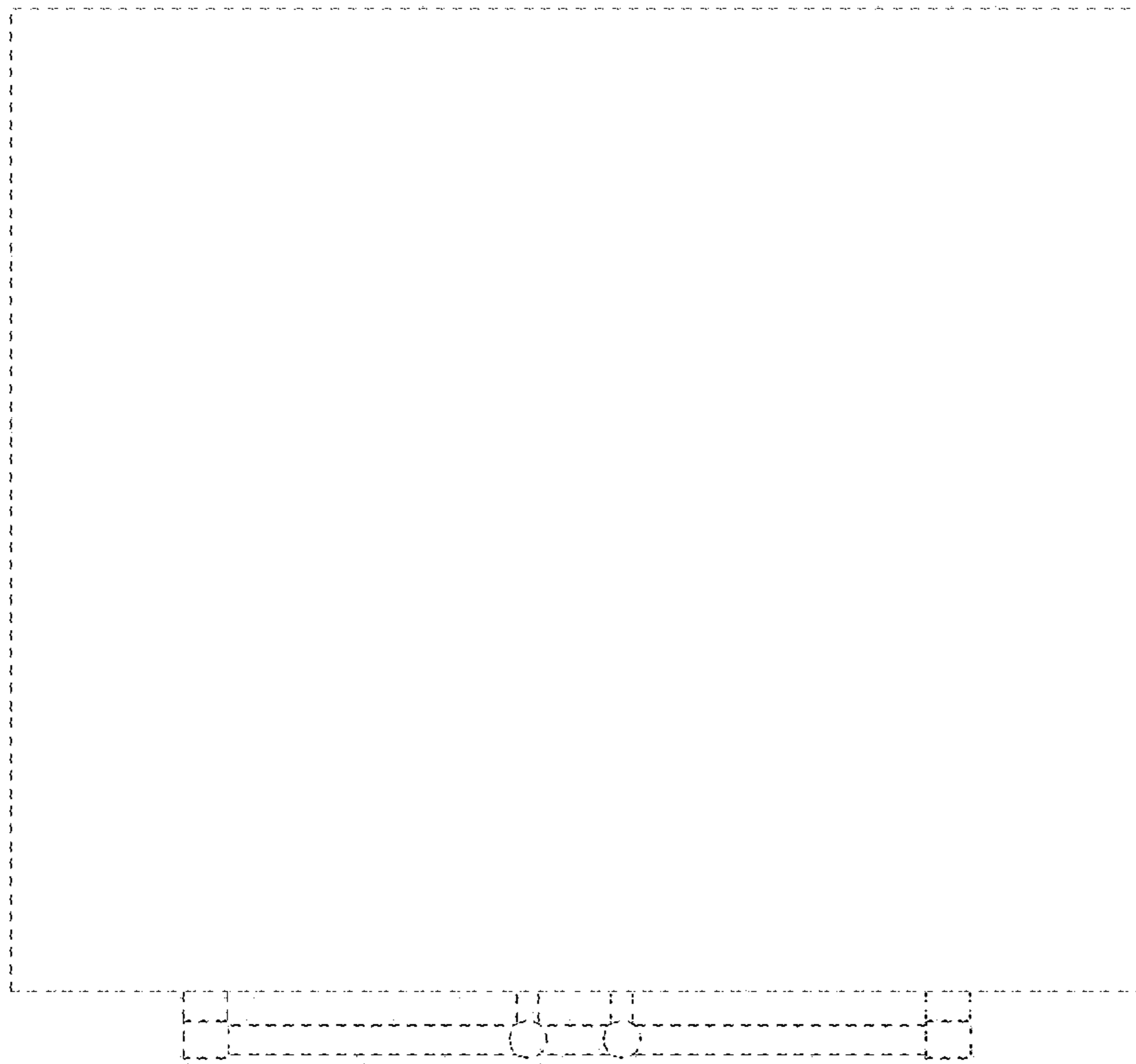

FIG. 38

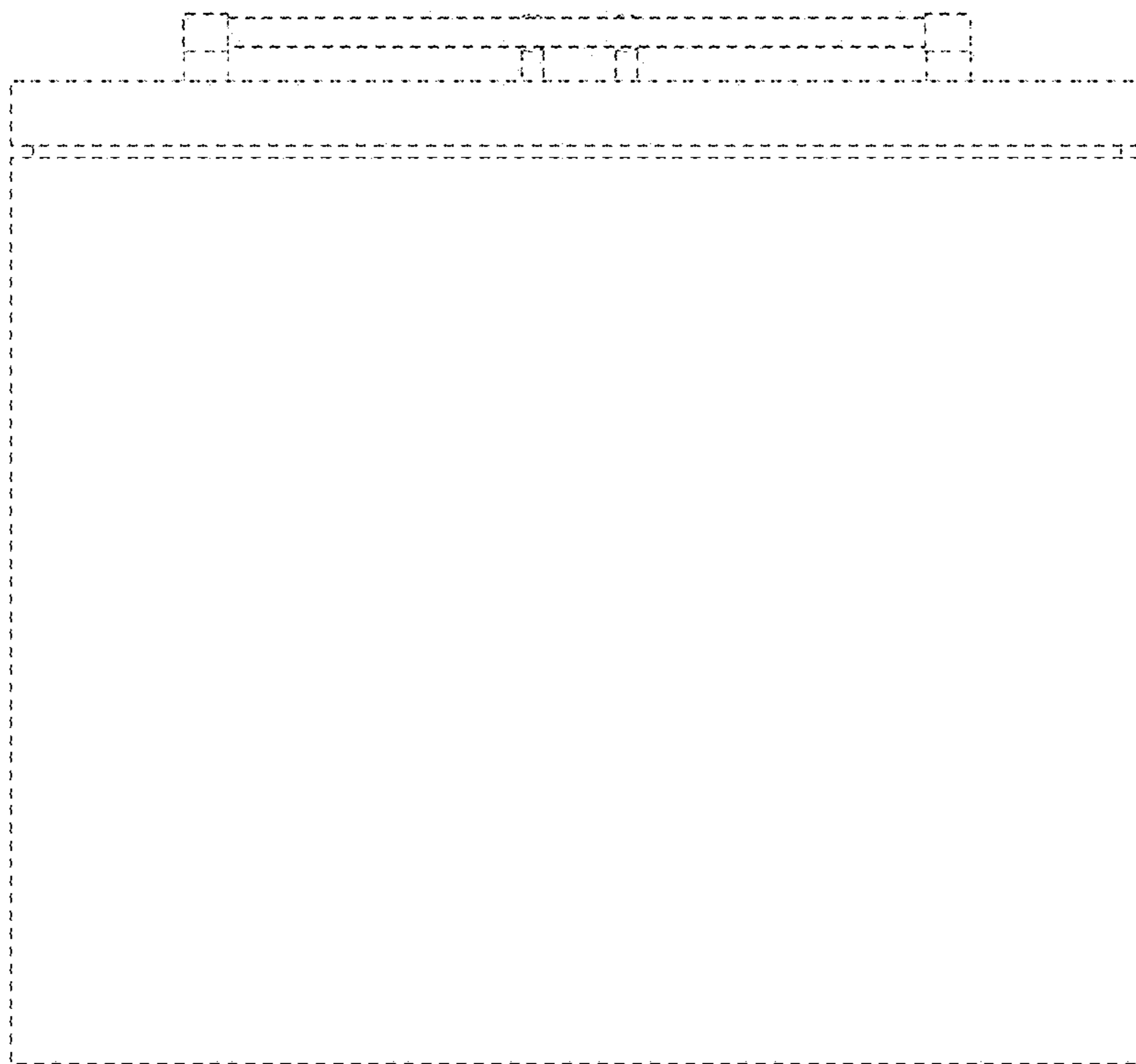

FIG. 39

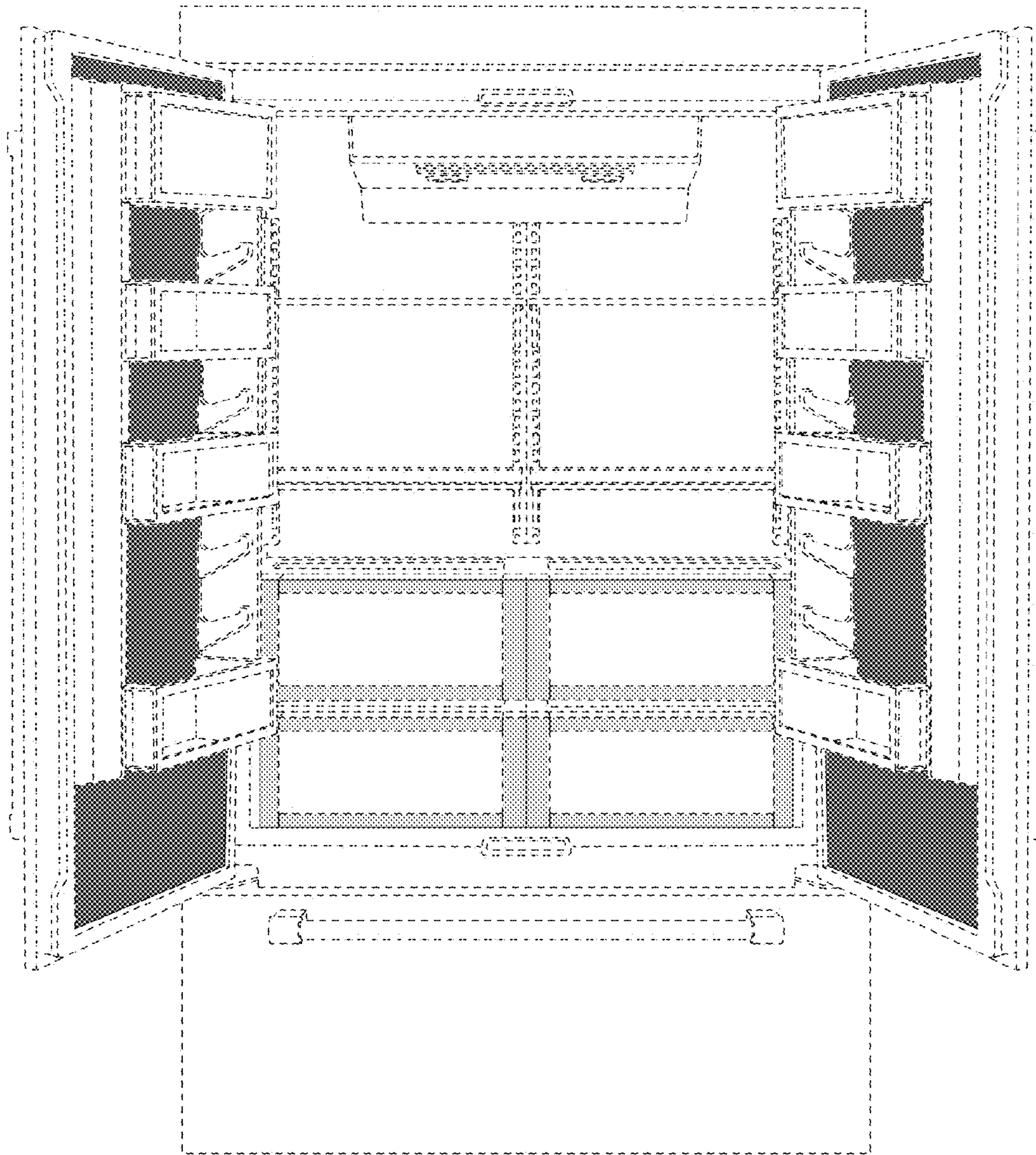

FIG. 40

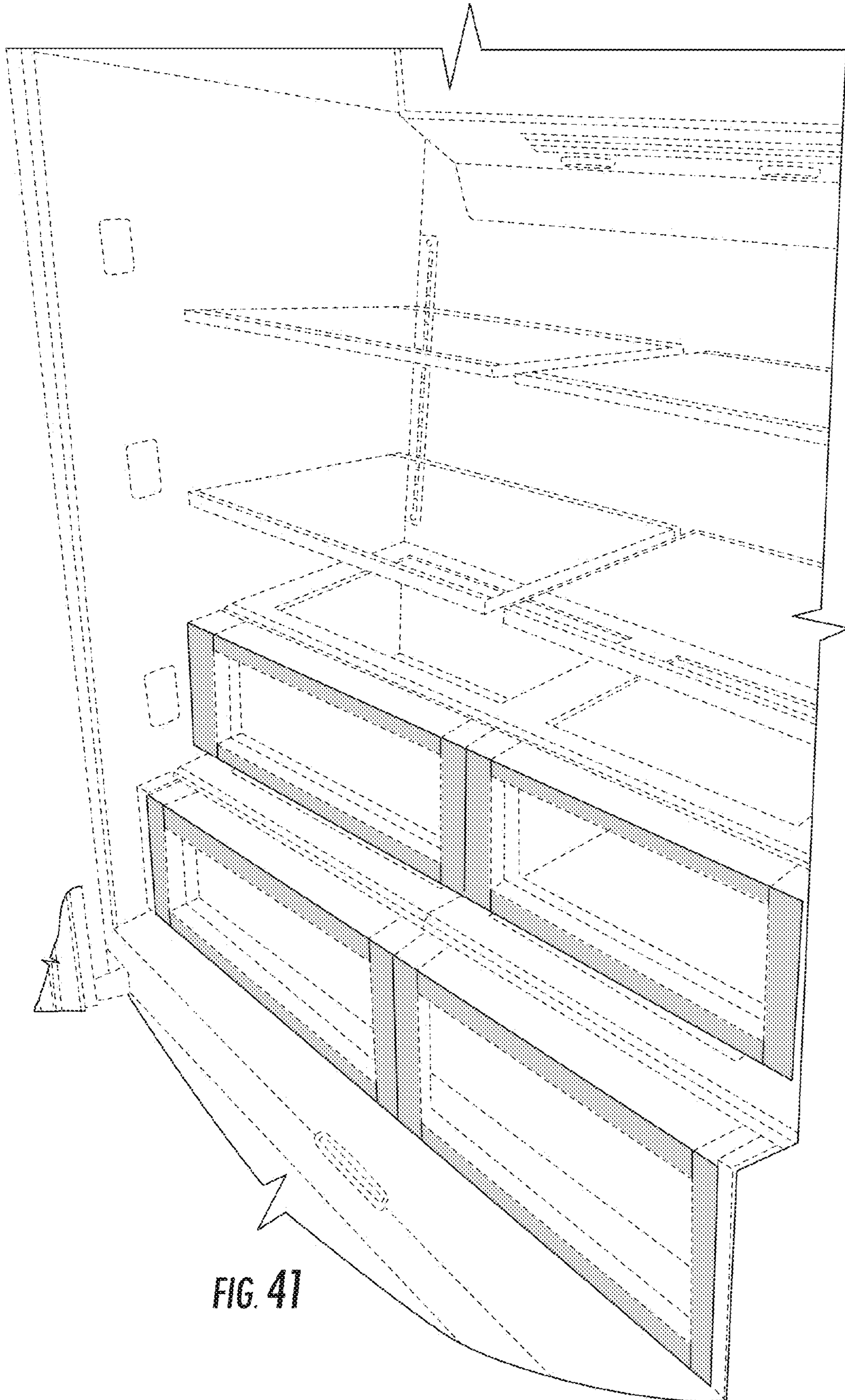

FIG. 41

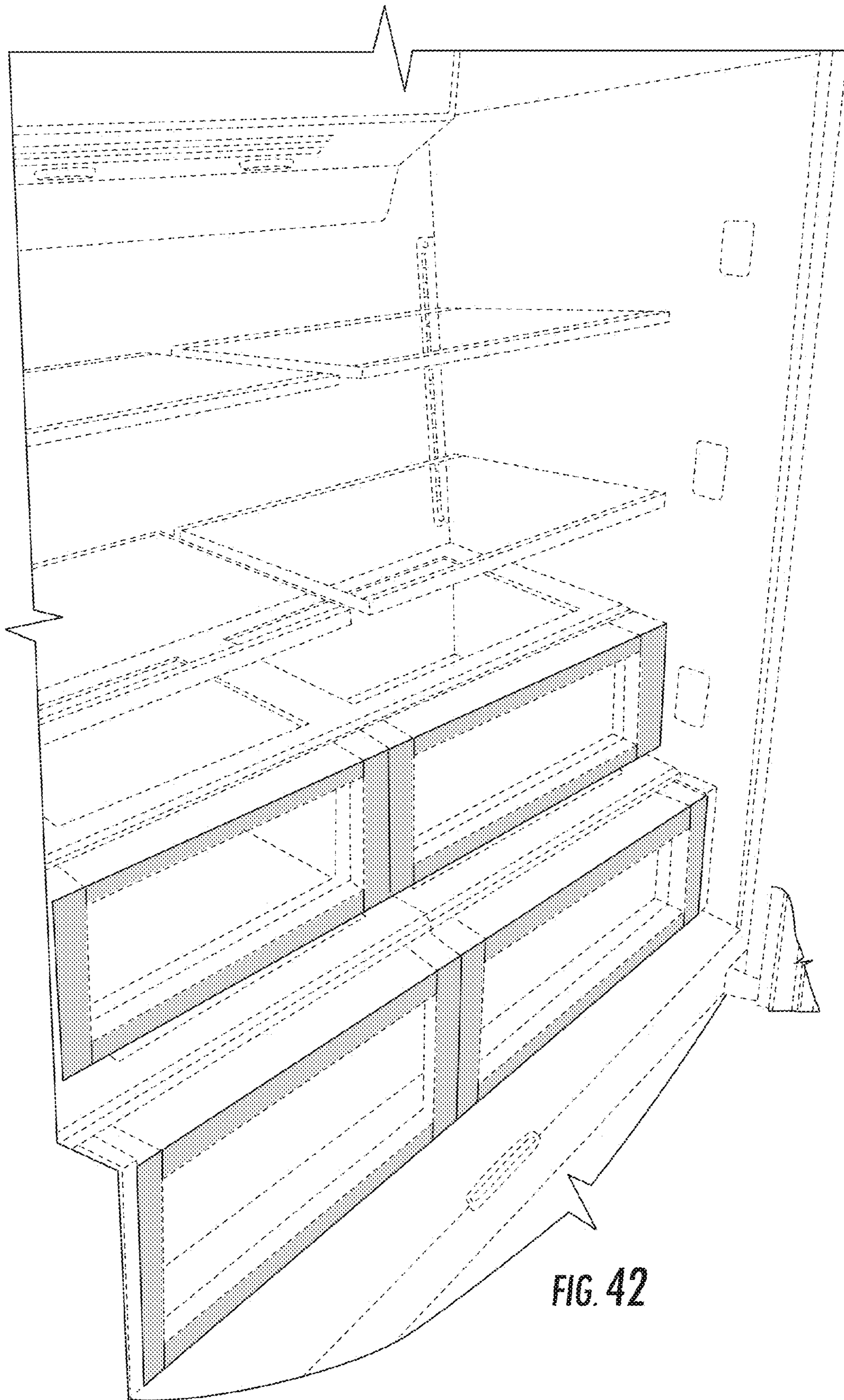

FIG. 42

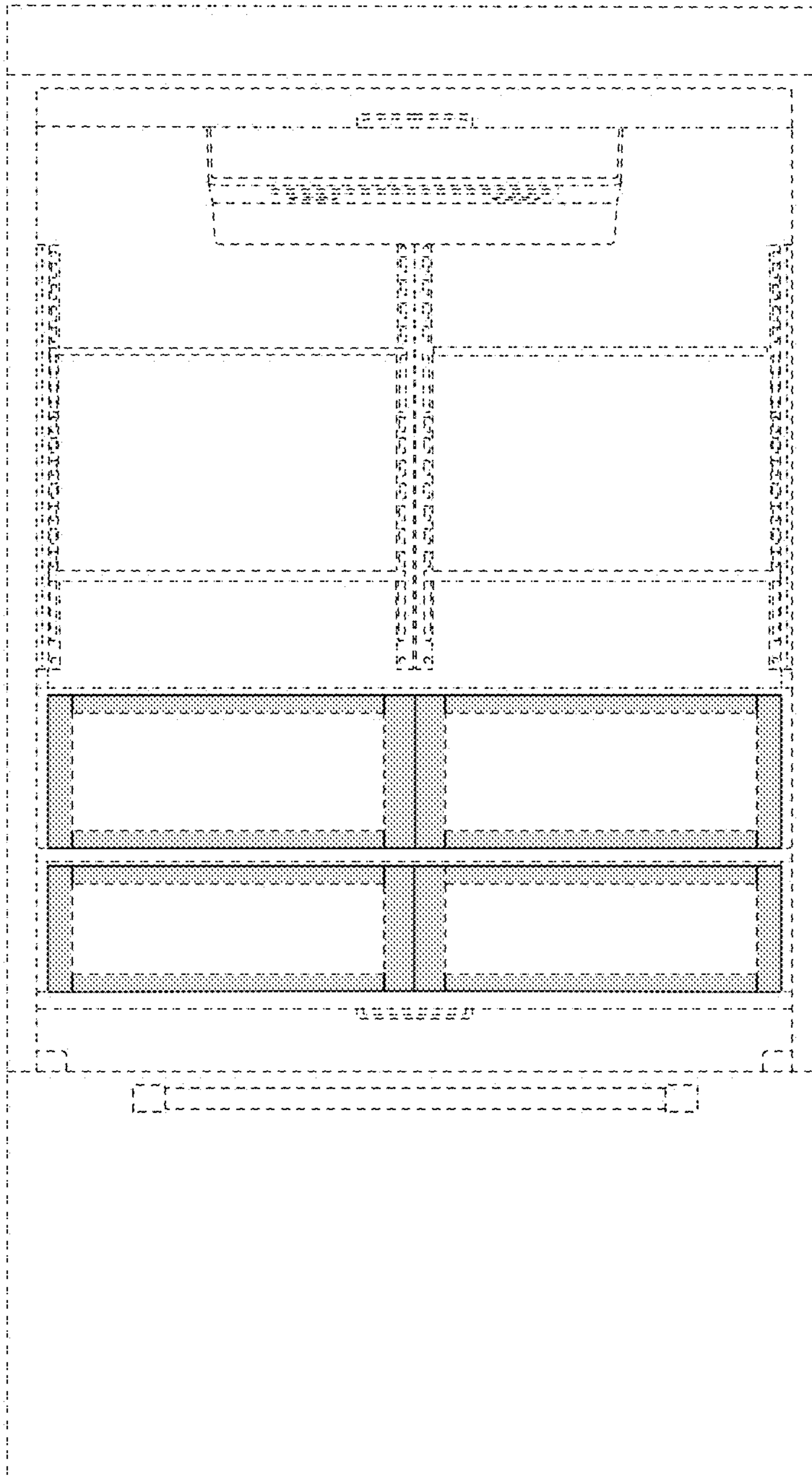

FIG. 43

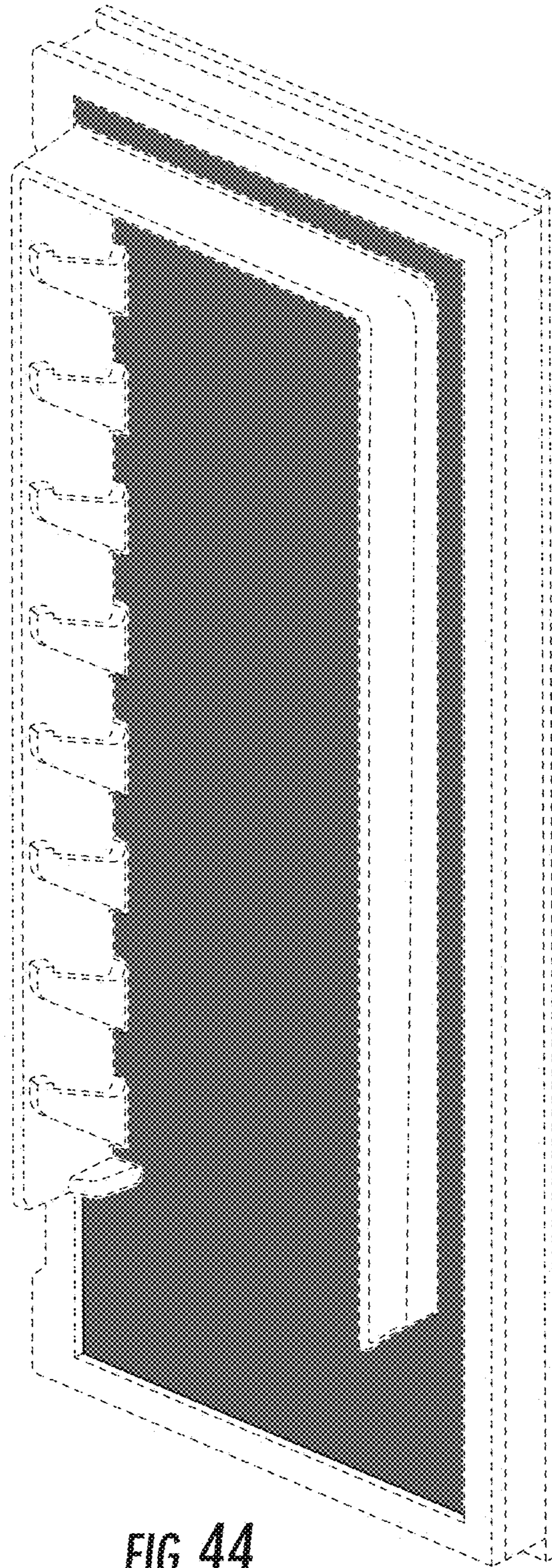

FIG. 44

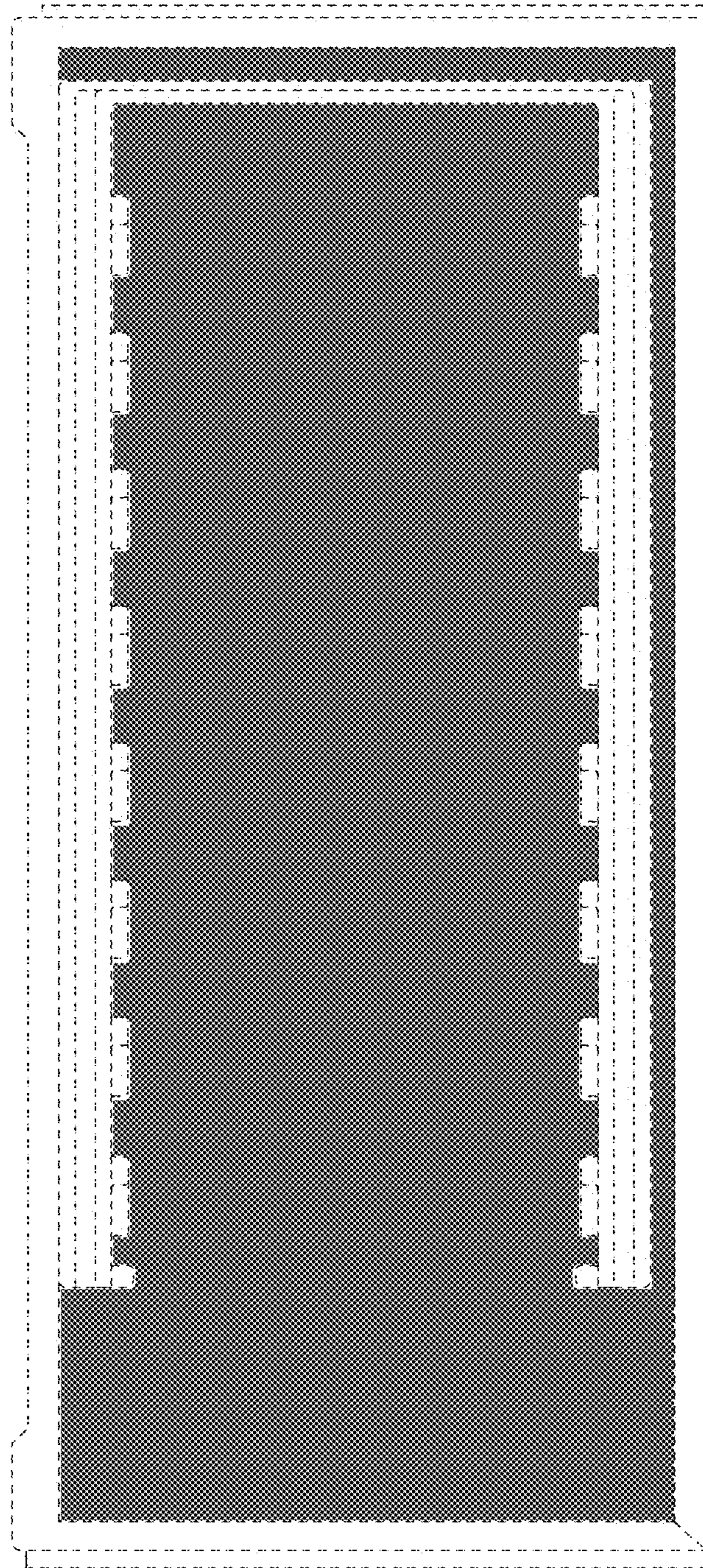

FIG. 45

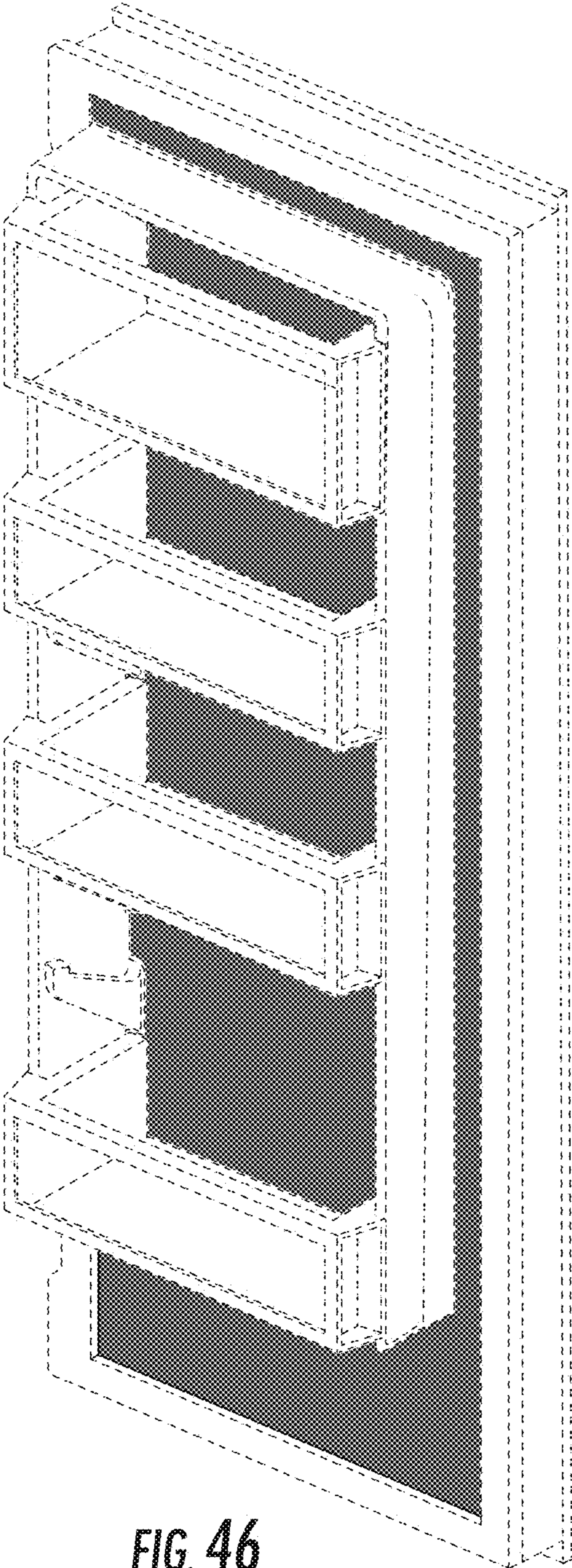

FIG. 46

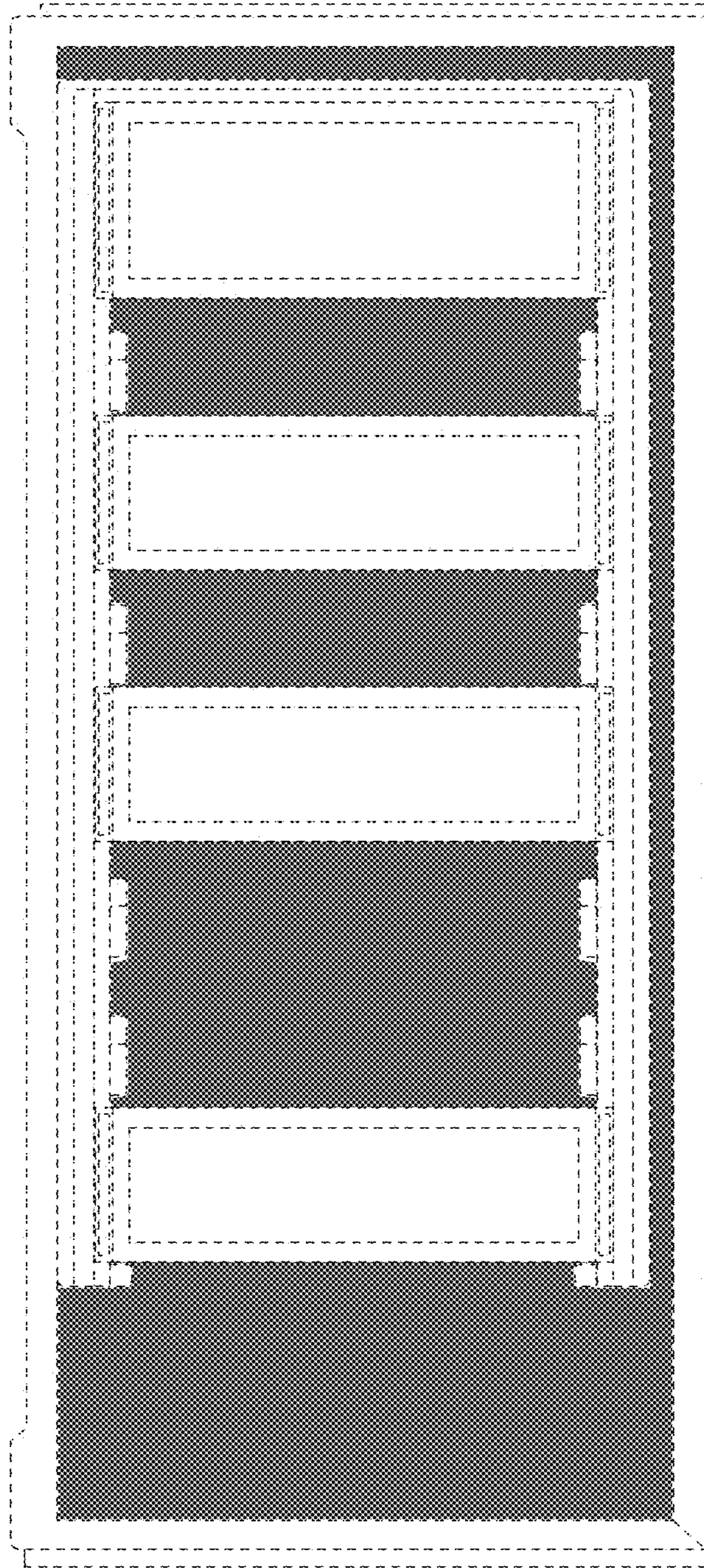

FIG. 47

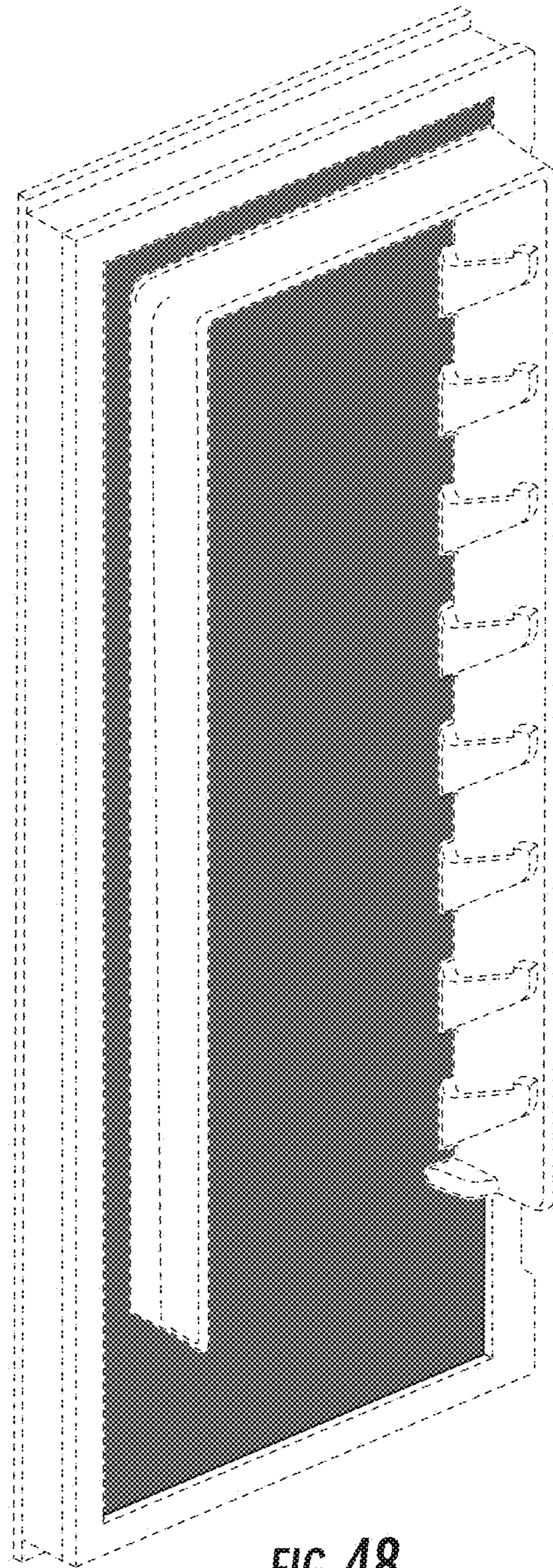

FIG. 48

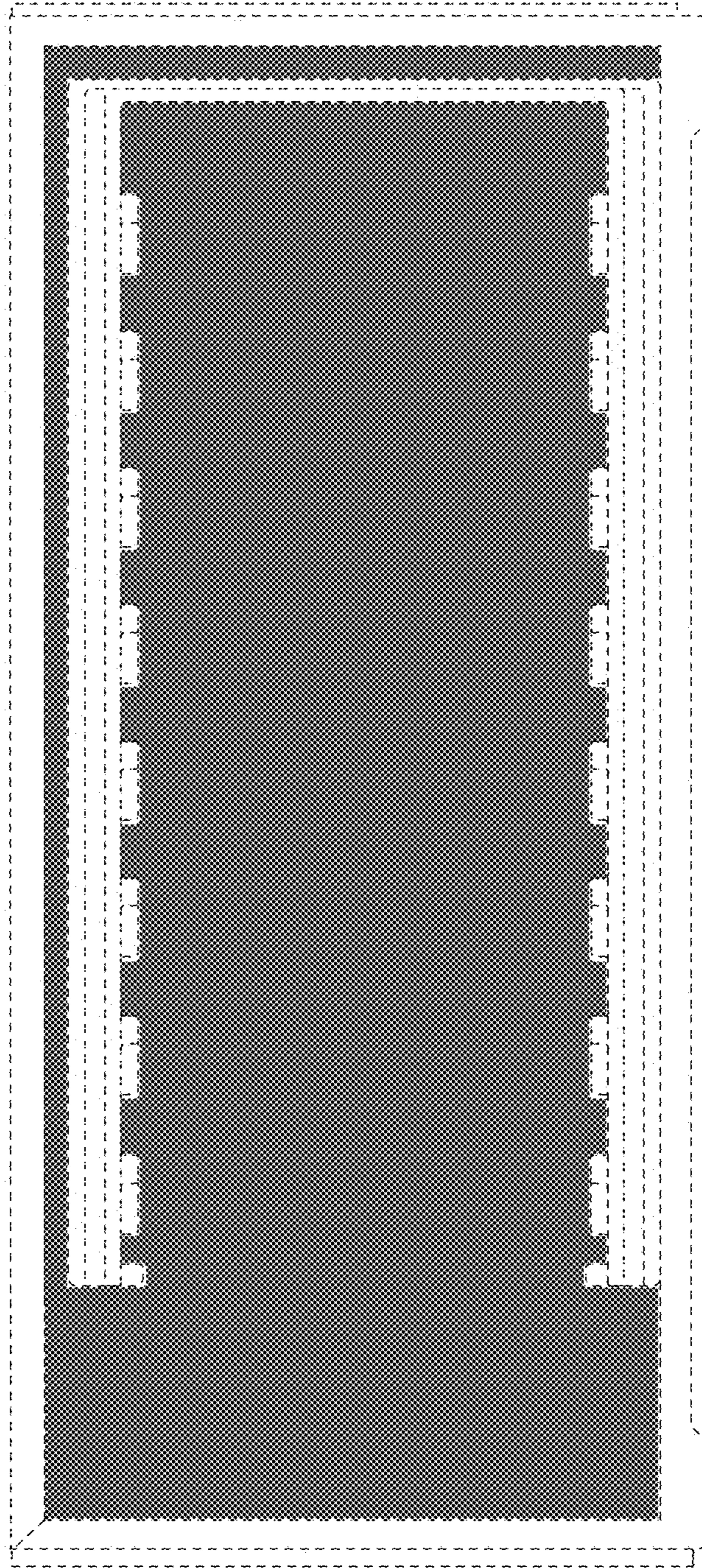

FIG. 49

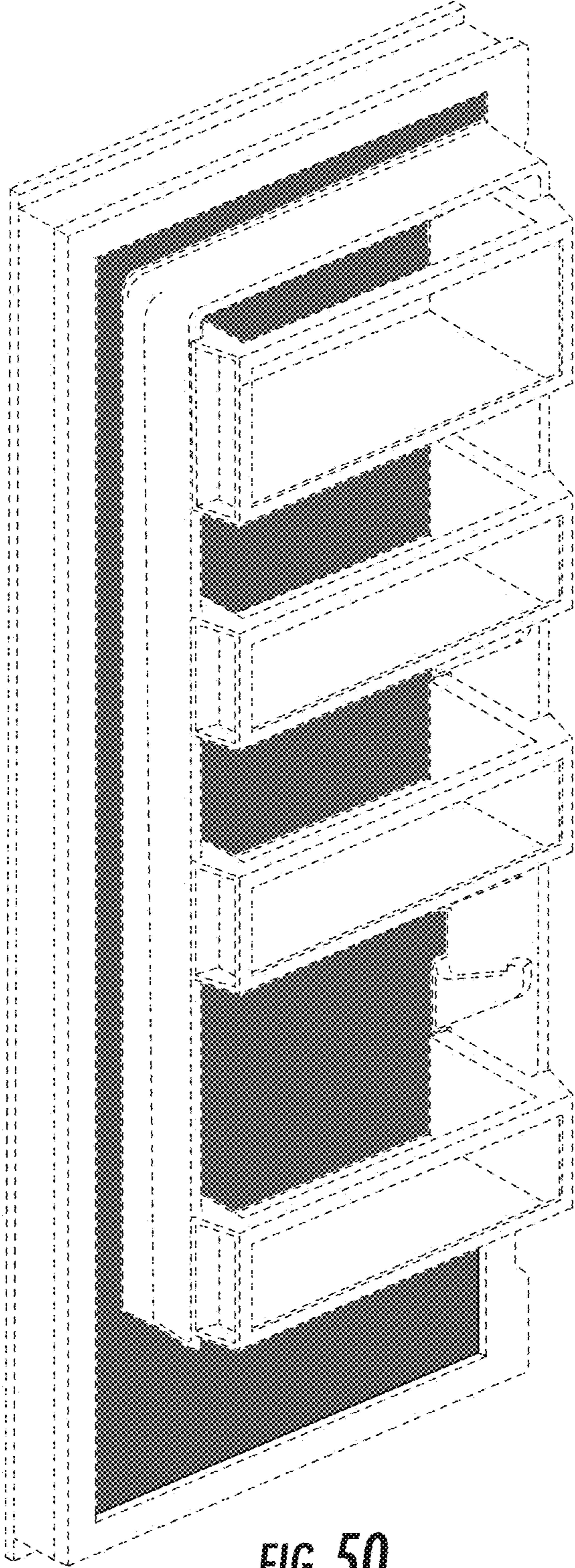

FIG. 50

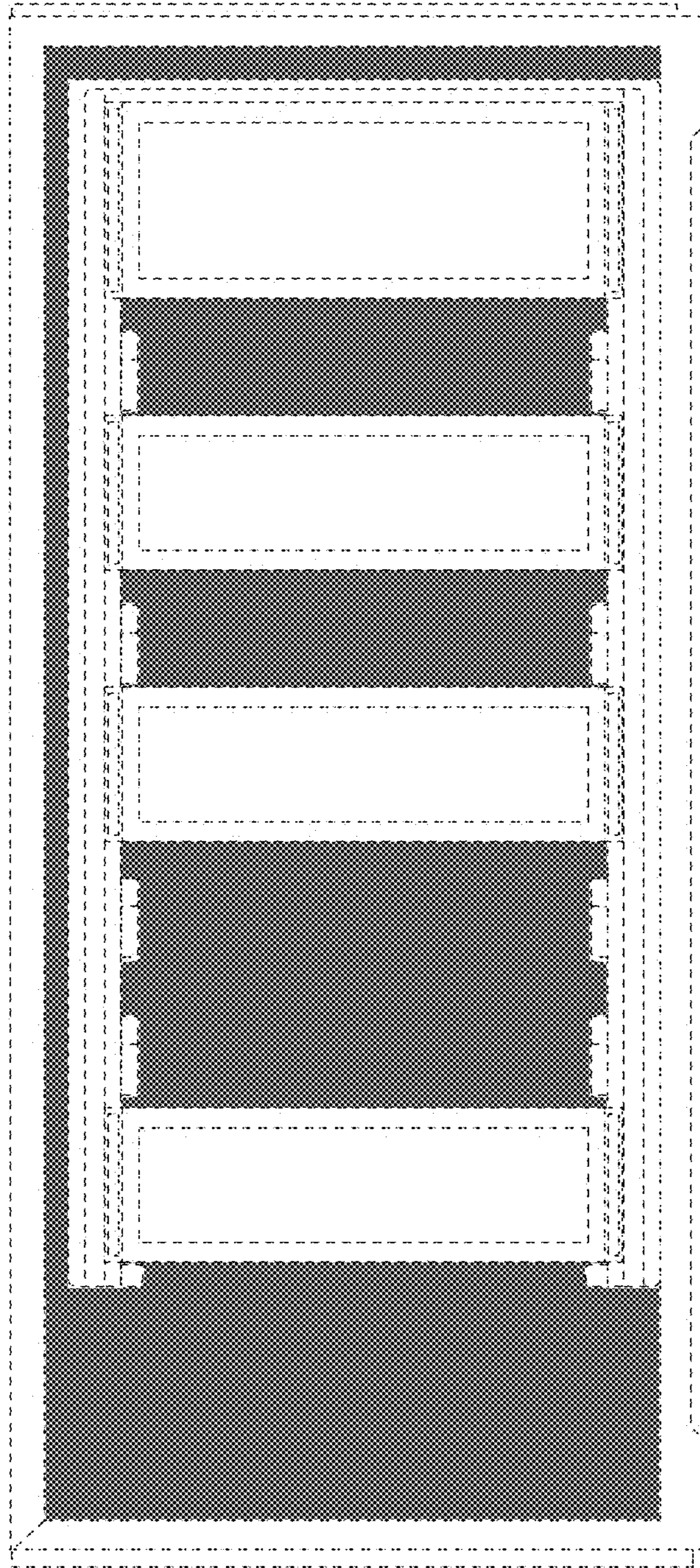

FIG. 51