



US00D762218S

(12) **United States Design Patent**  
**Sirichai**

(10) **Patent No.:** **US D762,218 S**  
(45) **Date of Patent:** **\*\* Jul. 26, 2016**

- (54) **REVERSIBLE CASE FOR MOBILE COMMUNICATIONS DEVICE WITH UNIVERSAL DEVICE-HOLDING MECHANISM**
- (71) Applicant: **World Richman Manufacturing Corporation, Elgin, IL (US)**
- (72) Inventor: **Sarahut Sirichai, Bangkok (TH)**
- (73) Assignee: **WORLD RICHMAN MANUFACTURING CORPORATION, Elgin, IL (US)**
- (\*\*) Term: **14 Years**
- (21) Appl. No.: **29/486,326**
- (22) Filed: **Mar. 28, 2014**
- (51) **LOC (10) Cl.** ..... **14-02**
- (52) **U.S. Cl.**  
USPC ..... **D14/440**
- (58) **Field of Classification Search**  
USPC ..... D14/250, 251, 253, 240, 217, 496, 440, D14/203.3, 203.4, 203.5, 203.8, 341, 318; D3/218, 215, 201, 294, 289, 900; 220/4.02; 248/309.1; 361/679.56; 379/426, 433.11, 455; 455/575.1, 455/575.8, 457.1; 190/100; 206/305, 320, 206/45.2; D21/469; 312/240  
CPC ... G06F 1/1601; G06F 1/1626; G06F 1/1633; G06F 1/1675; G06F 1/1679; G02F 1/1306; G02F 1/133; G02F 1/133308; G02F 1/153; G02F 1/1533; G02F 2001/133317; H04M 1/185; H04M 1/0252; H04B 1/3888  
See application file for complete search history.

6,772,879	B1 *	8/2004	Domotor	.....	206/45.23
7,281,698	B2 *	10/2007	Patterson, Jr.	.....	248/458
7,414,833	B2 *	8/2008	Kittayapong	.....	361/679.27
7,735,644	B2 *	6/2010	Sirichai et al.	.....	206/320
D658,187	S *	4/2012	Diebel	.....	D14/440
D658,188	S *	4/2012	Diebel	.....	D14/440
D663,304	S *	7/2012	Akana et al.	.....	D14/440
8,230,992	B2 *	7/2012	Law et al.	.....	206/320
8,245,843	B1 *	8/2012	Wu	.....	206/320
8,312,991	B2 *	11/2012	Diebel et al.	.....	206/45.24
D671,948	S *	12/2012	Akana et al.	.....	D14/440
D672,353	S *	12/2012	Liu	.....	D14/440
D672,781	S *	12/2012	Lu	.....	D14/440
D675,625	S *	2/2013	Hasbrook et al.	.....	D14/440
D678,260	S *	3/2013	Bau	.....	D14/250
D679,279	S *	4/2013	Yang et al.	.....	D14/440
D679,715	S *	4/2013	Akana et al.	.....	D14/440
8,424,830	B2 *	4/2013	Yang et al.	.....	248/459
D681,641	S *	5/2013	Van Den Nieuwenhuizen et al.	.....	D14/440
D682,836	S *	5/2013	Akana et al.	.....	D14/440
D682,838	S *	5/2013	Akana et al.	.....	D14/440
D683,141	S *	5/2013	Symons	.....	D6/310
D684,978	S *	6/2013	Phillips et al.	.....	D14/440
D686,629	S *	7/2013	Trinh et al.	.....	D14/447
D687,438	S *	8/2013	Lu	.....	D14/440
D688,250	S *	8/2013	Phillips et al.	.....	D14/440
D690,305	S *	9/2013	Wen	.....	D14/440
D690,702	S *	10/2013	Chung	.....	D14/440
D691,142	S *	10/2013	Diebel	.....	D14/440
D692,434	S *	10/2013	Kim	.....	D14/440
D693,823	S *	11/2013	Chen et al.	.....	D14/440
D695,296	S *	12/2013	Hsu	.....	D14/440
D696,253	S *	12/2013	Akana et al.	.....	D14/345
D696,256	S *	12/2013	Piedra et al.	.....	D14/440
D696,669	S *	12/2013	Akana et al.	.....	D14/440
8,640,864	B2 *	2/2014	Chen et al.	.....	206/45.2
8,644,893	B2 *	2/2014	Liang	.....	455/575.1
8,657,112	B2 *	2/2014	Igarashi	.....	206/320
D701,205	S *	3/2014	Akana et al.	.....	D14/345
D702,673	S *	4/2014	Murchison et al.	.....	D14/250
D704,689	S *	5/2014	Chang	.....	D14/250
D704,693	S *	5/2014	Kim	.....	D14/250
D706,270	S *	6/2014	Akana et al.	.....	D14/440
D706,783	S *	6/2014	Almodova	.....	D14/440
D707,229	S *	6/2014	Almodova	.....	D14/440
8,757,375	B2 *	6/2014	Huang	.....	206/320
D708,838	S *	7/2014	Lee	.....	D3/201
8,763,795	B1 *	7/2014	Oten et al.	.....	206/45.23
8,766,921	B2 *	7/2014	Ballagas et al.	.....	345/168
8,773,353	B2 *	7/2014	Wei	.....	345/156
8,783,458	B2 *	7/2014	Gallagher et al.	.....	206/320
D710,859	S *	8/2014	Mecchella et al.	.....	D14/440

(56) **References Cited**

**U.S. PATENT DOCUMENTS**

1,613,536	A *	1/1927	Rose	.....	132/315
D118,197	S *	12/1939	Trussell	.....	D19/26
D230,376	S *	2/1974	Andrew	.....	D19/91
4,259,568	A *	3/1981	Dynesen	.....	235/1 D

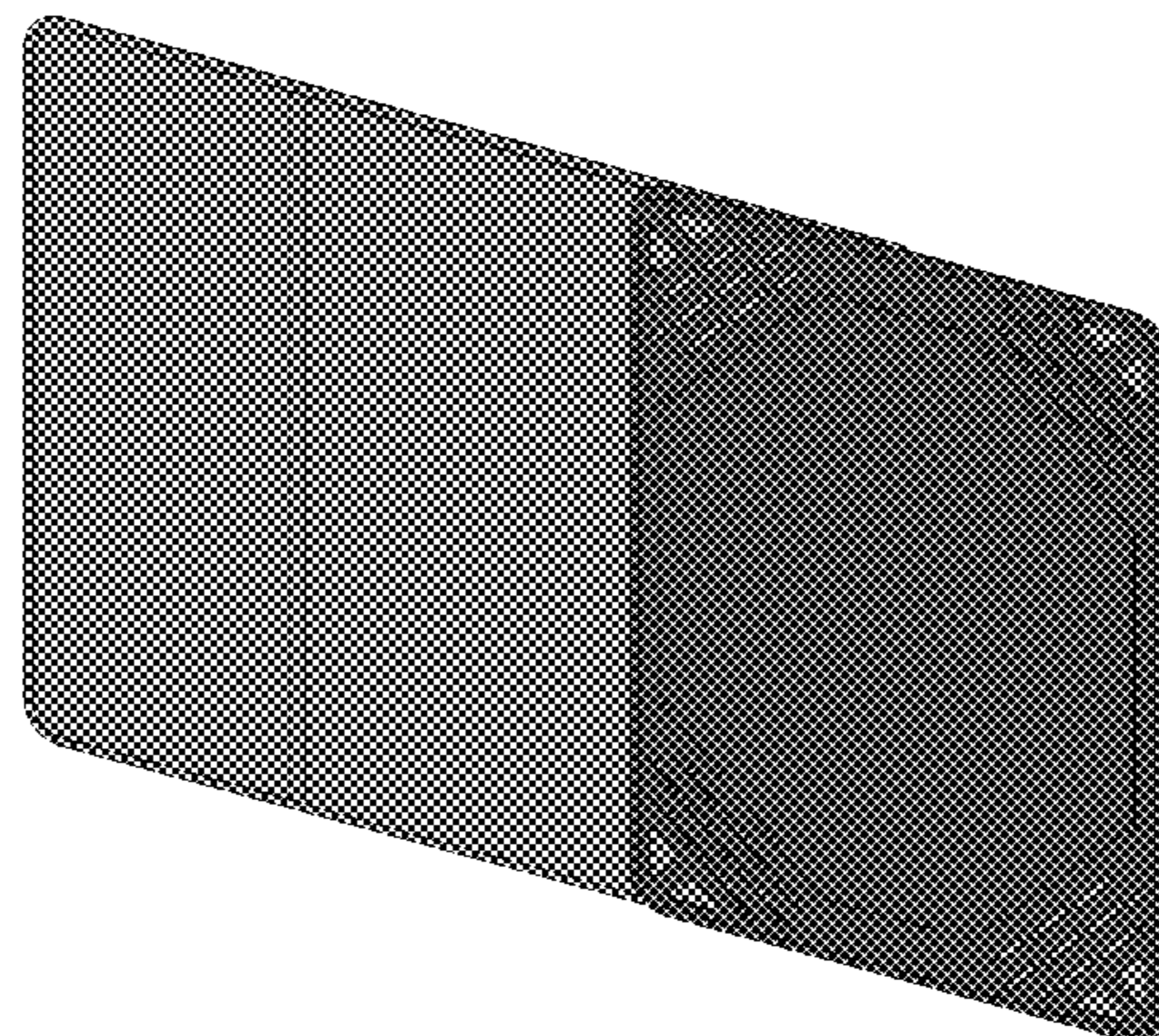

8,797,132	B2 *	8/2014	Childs et al. ....	335/219
D723,570	S *	3/2015	Sirichai .....	D14/440
D724,595	S *	3/2015	Sirichai .....	D14/440
D724,596	S *	3/2015	Sirichai .....	D14/440
2003/0034263	A1 *	2/2003	D'Hoste .....	206/320
2008/0302687	A1 *	12/2008	Sirichai et al. ....	206/320
2009/0159763	A1 *	6/2009	Kim .....	248/174
2011/0266194	A1 *	11/2011	Bau .....	206/736
2011/0290687	A1 *	12/2011	Han .....	206/320
2012/0091312	A1 *	4/2012	Baker .....	248/682
2012/0211377	A1 *	8/2012	Sajid .....	206/216
2012/0211613	A1 *	8/2012	Yang et al. ....	248/174
2012/0305413	A1 *	12/2012	Chung .....	206/45.23
2012/0308981	A1 *	12/2012	Libin et al. ....	434/362
2013/0015088	A1 *	1/2013	Wu .....	206/320
2013/0020216	A1 *	1/2013	Chiou .....	206/320
2013/0140203	A1 *	6/2013	Chiang .....	206/320
2013/0213838	A1 *	8/2013	Tsai et al. ....	206/320
2013/0214661	A1 *	8/2013	McBroom .....	312/325
2013/0241381	A1 *	9/2013	Hynecek et al. ....	312/240
2013/0264459	A1 *	10/2013	McCosh et al. ....	248/688

\* cited by examiner

*Primary Examiner* — Cynthia Underwood

(74) *Attorney, Agent, or Firm* — Christopher J. Scott

(57) **CLAIM**

The ornamental design for the reversible case for a mobile communications device with universal device-holding mechanism, as shown and described.

**DESCRIPTION**

FIG. 1 is a first frontal perspective view of the reversible case for a mobile communications device with universal device-holding mechanism presented in grayscale coloration showing a cover portion in a first open position to show first coloration of a first side of the cover portion.

FIG. 2 is a second frontal perspective view of the reversible case for a mobile communications device with universal device-holding mechanism presented in grayscale coloration and showing the cover portion in a second open position to show second coloration of a second side of the cover portion.

FIG. 3 is a first lateral edge view of the reversible case for a mobile communications device with universal device-holding mechanism presented in grayscale coloration and showing the cover portion in the second open position in solid outlines and also showing an environment of use in which the cover portion is in a series of intermediate open positions between the second open position and the first open position in broken lines.

FIG. 4 is a third frontal perspective view of the reversible case for a mobile communications device with universal device-holding mechanism presented in grayscale coloration and showing the cover portion in the first open position in solid lines and also showing an environment of use in which the cover portion is in a series of intermediary open positions between the second open position and the first open position in broken lines.

FIG. 5 is a first rear perspective view of the reversible case for a mobile communications device with universal device-holding mechanism presented in grayscale coloration and showing the cover portion in the first open position to show second coloration of the second side of the cover portion.

FIG. 6 is a second rear perspective view of the reversible case for a mobile communications device with universal device-holding mechanism presented in grayscale coloration and showing the cover portion in a second open position to show first coloration of the first side of the cover portion.

FIG. 7 is a first frontal plan view of the reversible case for a mobile communications device with universal device-holding mechanism presented in grayscale coloration and showing the cover portion in the first open position to show first coloration of the first side of the cover portion.

FIG. 8 is a first rear plan view of the reversible case for a mobile communications device with universal device-holding mechanism presented in grayscale coloration and showing the cover portion in the first open position to show second coloration of the second side of the cover portion.

FIG. 9 is a second rear plan view of the reversible case for a mobile communications device with universal device-holding mechanism presented in grayscale coloration and showing the cover portion in the second open position to show first coloration of the first side of the cover portion.

FIG. 10 is a second frontal plan view of the reversible case for a mobile communications device with universal device-holding mechanism presented in grayscale coloration and showing the cover portion in the second open position to show second coloration of the second side of the cover portion.

FIG. 11 is a first lateral edge view of the reversible case for a mobile communications device with universal device-holding mechanism presented in grayscale coloration and showing the cover portion in the first open position.

FIG. 12 is an enlarged fragmentary sectional view as sectioned from FIG. 11 to show in greater clarity the first coloration of the first side of the cover portion opposite the second coloration of the second side of the cover portion.

FIG. 13 is a first top plan view of the reversible case for a mobile communications device with universal device-holding mechanism presented in grayscale coloration and showing the cover portion in a first closed position to show first coloration of the first side of the cover portion.

FIG. 14 is a first bottom plan view of the reversible case for a mobile communications device with universal device-holding mechanism presented in grayscale coloration and showing the cover portion in the first closed position to show first coloration of the first side of the cover portion.

FIG. 15 is a first bottom perspective view of the reversible case for a mobile communications device with universal device-holding mechanism presented in grayscale coloration and showing the cover portion in the first closed position to show first coloration of the first side of the cover portion.

FIG. 16 is a first top perspective view of the reversible case for a mobile communications device with universal device-holding mechanism presented in grayscale coloration and showing the cover portion in the first closed position to show first coloration of the first side of the cover portion.

FIG. 17 is a first end view of the reversible case for a mobile communications device with universal device-holding mechanism presented in grayscale coloration and showing the cover portion in the first closed position.

FIG. 18 is a rear edge view of the reversible case for a mobile communications device with universal device-holding mechanism presented in grayscale coloration and showing the cover portion in the first closed position.

FIG. 19 is a front edge view of the reversible case for a mobile communications device with universal device-holding mechanism presented in grayscale coloration and showing the cover portion in the first closed position.

FIG. 20 is a second end view opposite the first end view of the reversible case for a mobile communications device with universal device-holding mechanism presented in grayscale coloration and showing the cover portion in the first closed position.

FIG. 21 is a frontal perspective view of the reversible case for a mobile communications device with universal device-holding mechanism presented in grayscale coloration and showing the cover portion in a first condition of rise.

FIG. 22 is a frontal elevational view of the reversible case for a mobile communications device with universal device-holding mechanism presented in grayscale coloration and showing the cover portion in the first condition of use.

FIG. 23 is a lateral edge view of the reversible case for a mobile communications device with universal device-holding mechanism presented in grayscale coloration and showing the cover portion in a condition of use.

FIG. 24 is a rear perspective view of the reversible case for a mobile communications device with universal device-holding mechanism presented in grayscale coloration and showing the cover portion in the first condition of use.

FIG. 25 is a first rear elevational view of the reversible case for a mobile communications device with universal device-hold-

ing mechanism presented in grayscale coloration and showing the cover portion in the first condition of use.

FIG. 26 is a top plan view of the reversible case for a mobile communications device with universal device-holding mechanism presented in grayscale coloration and showing the cover portion in the first condition of use; and,

FIG. 27 is a bottom plan view of the reversible case for a mobile communications device with universal device-holding mechanism presented in grayscale coloration and showing the cover portion in the first condition of use.

All broken lines are included for the purpose of illustrating intermediary positions of the cover portion of the reversible case for a mobile communications device with universal device-holding mechanism and form no part of the claimed design.

**1 Claim, 23 Drawing Sheets**

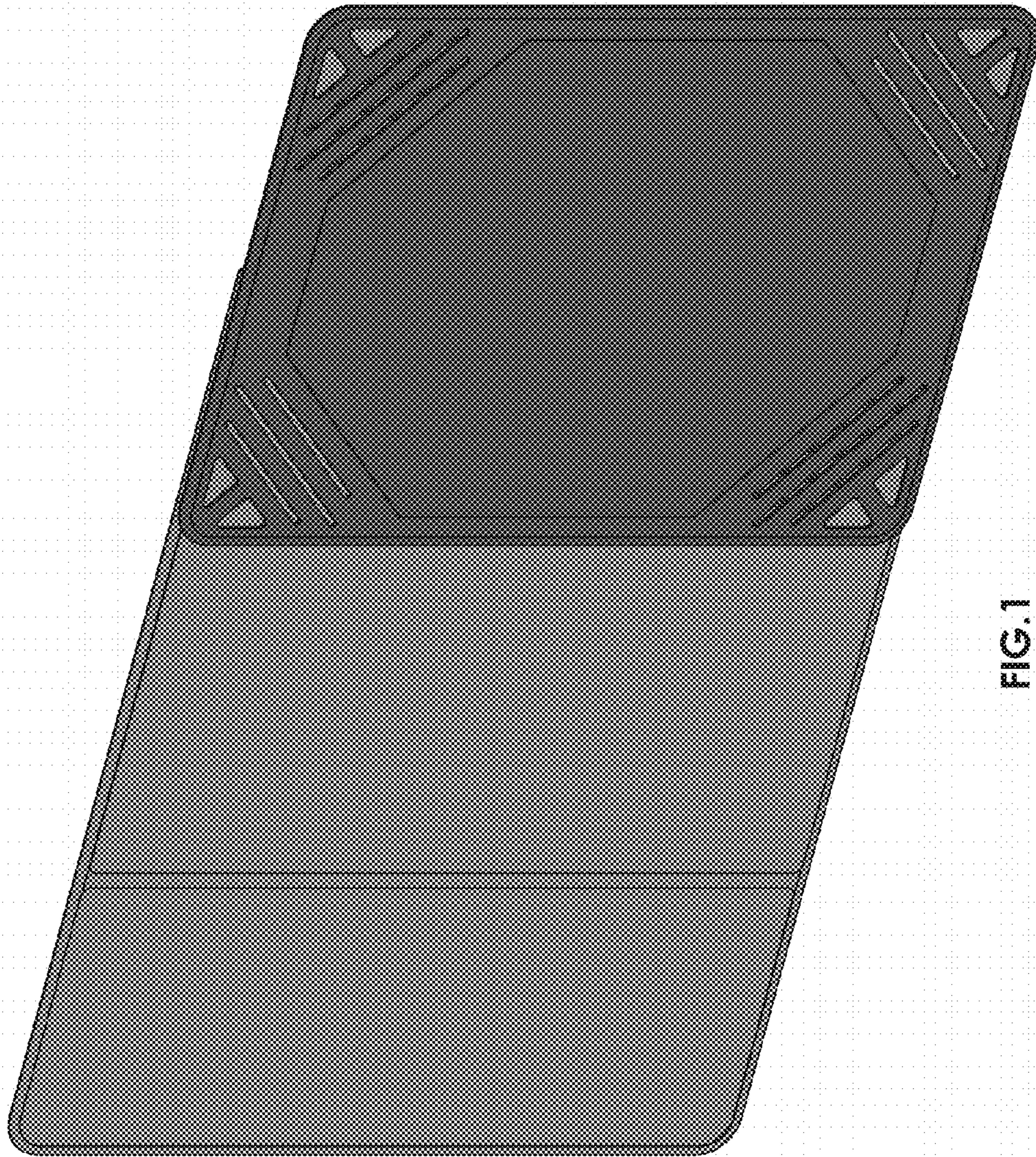

FIG. 1

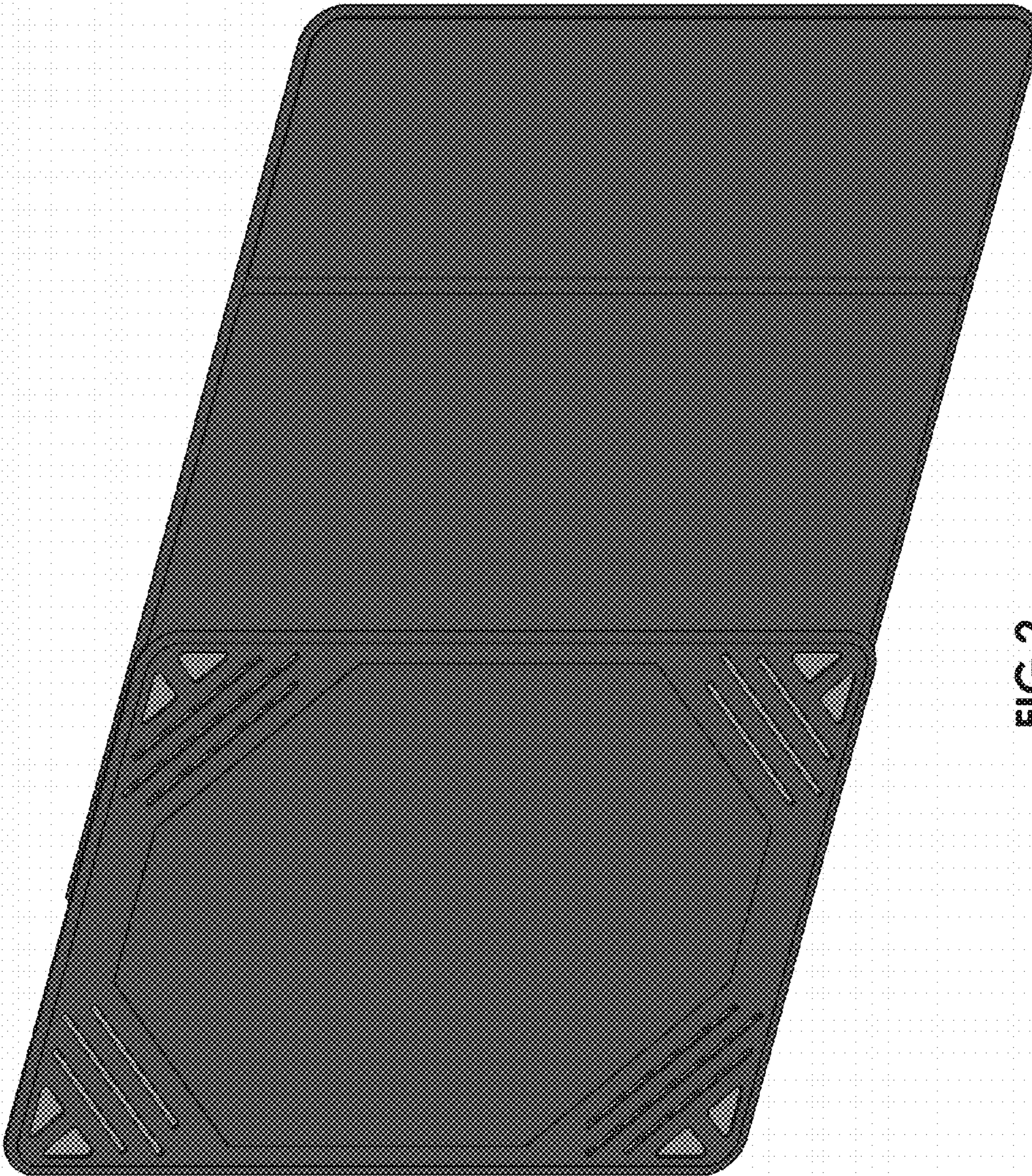

FIG. 2

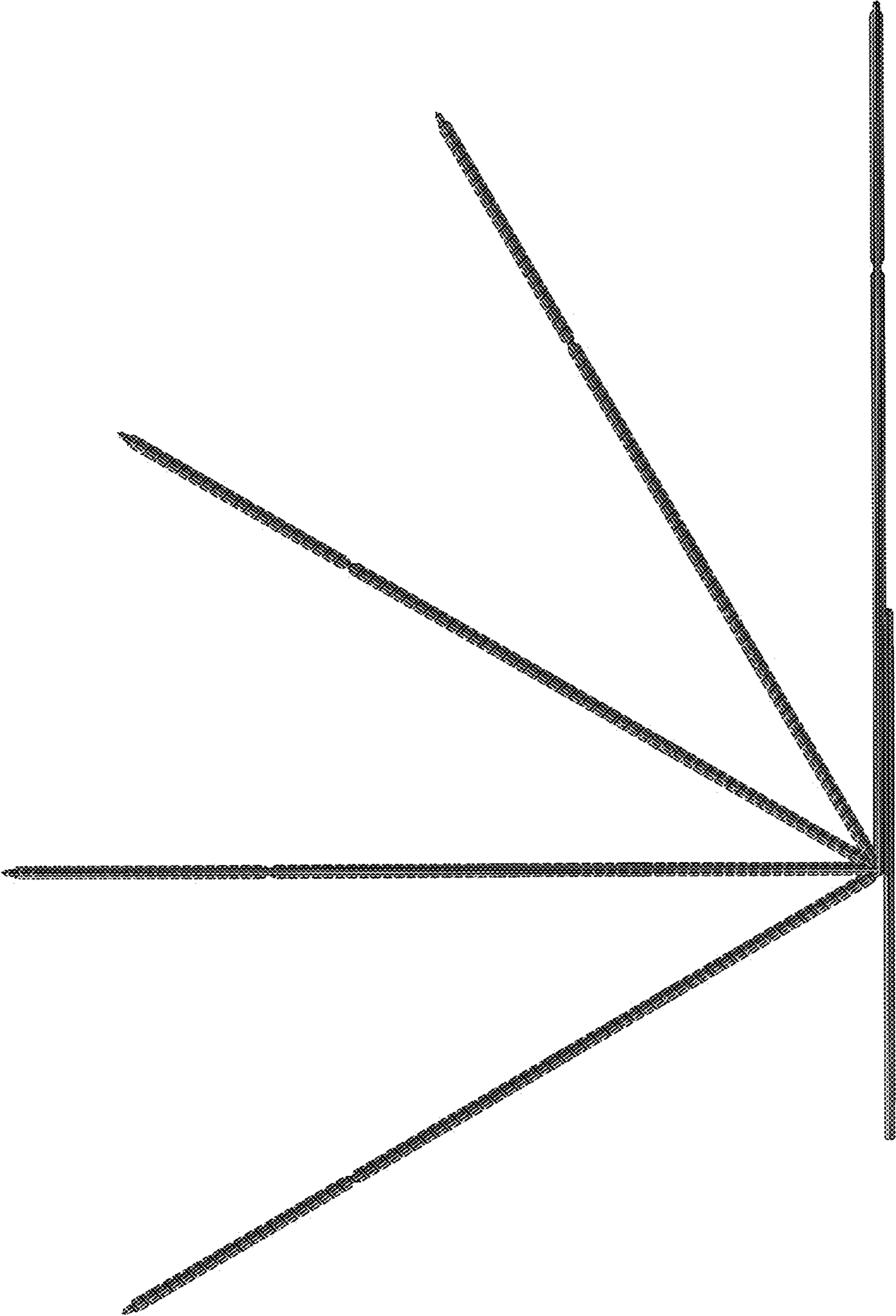

FIG.3

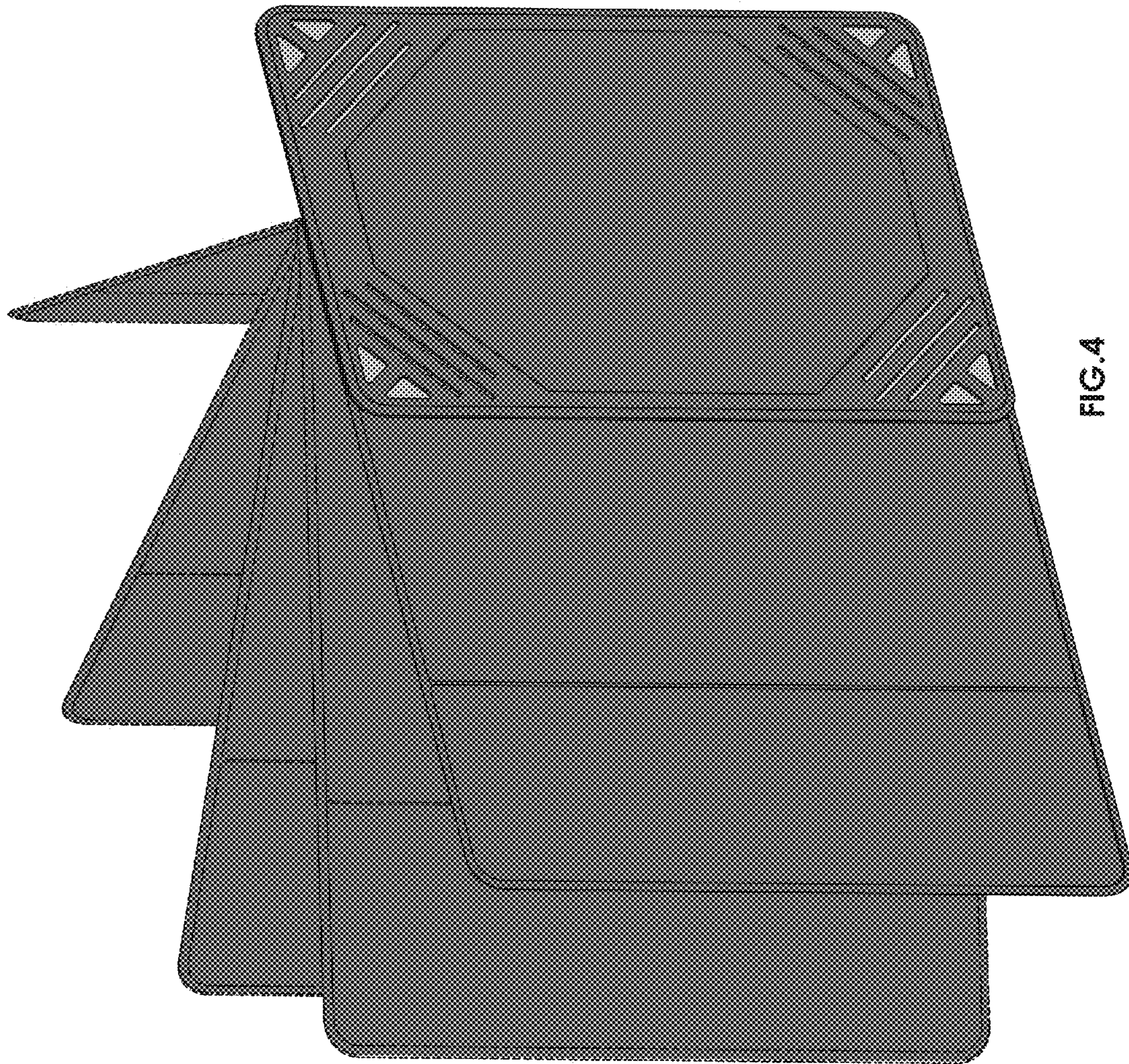

FIG. 4

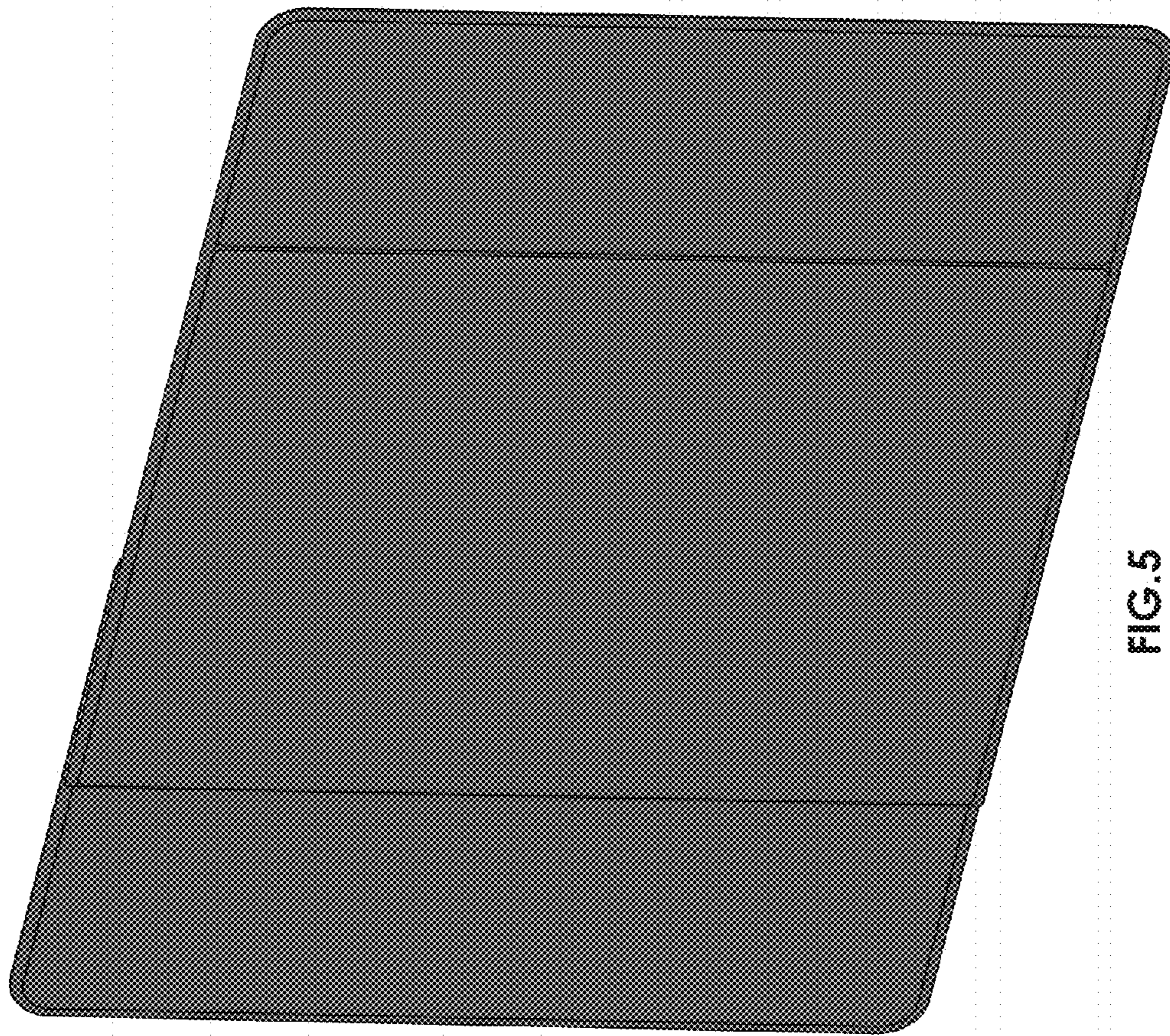

FIG. 5



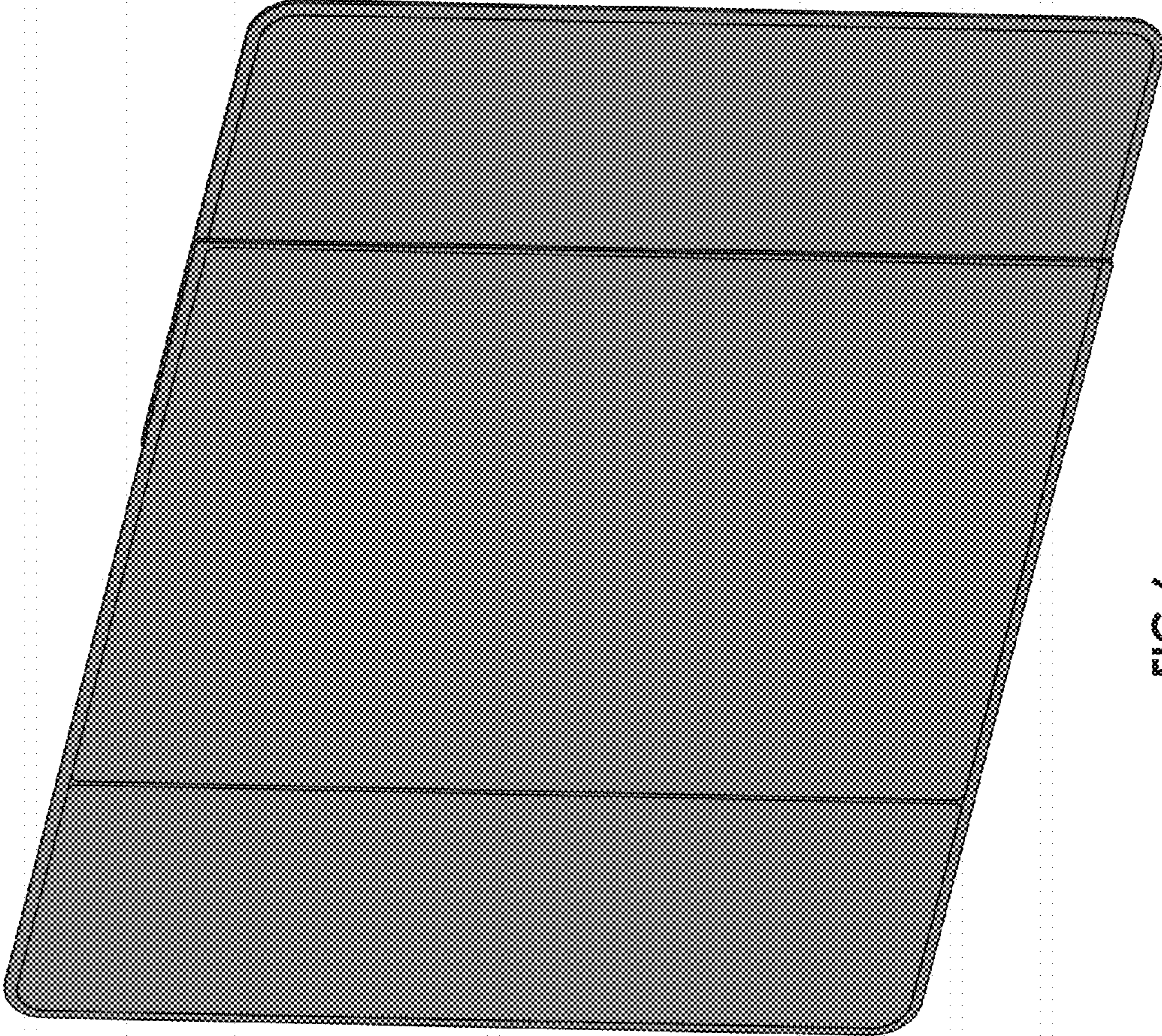

FIG.6

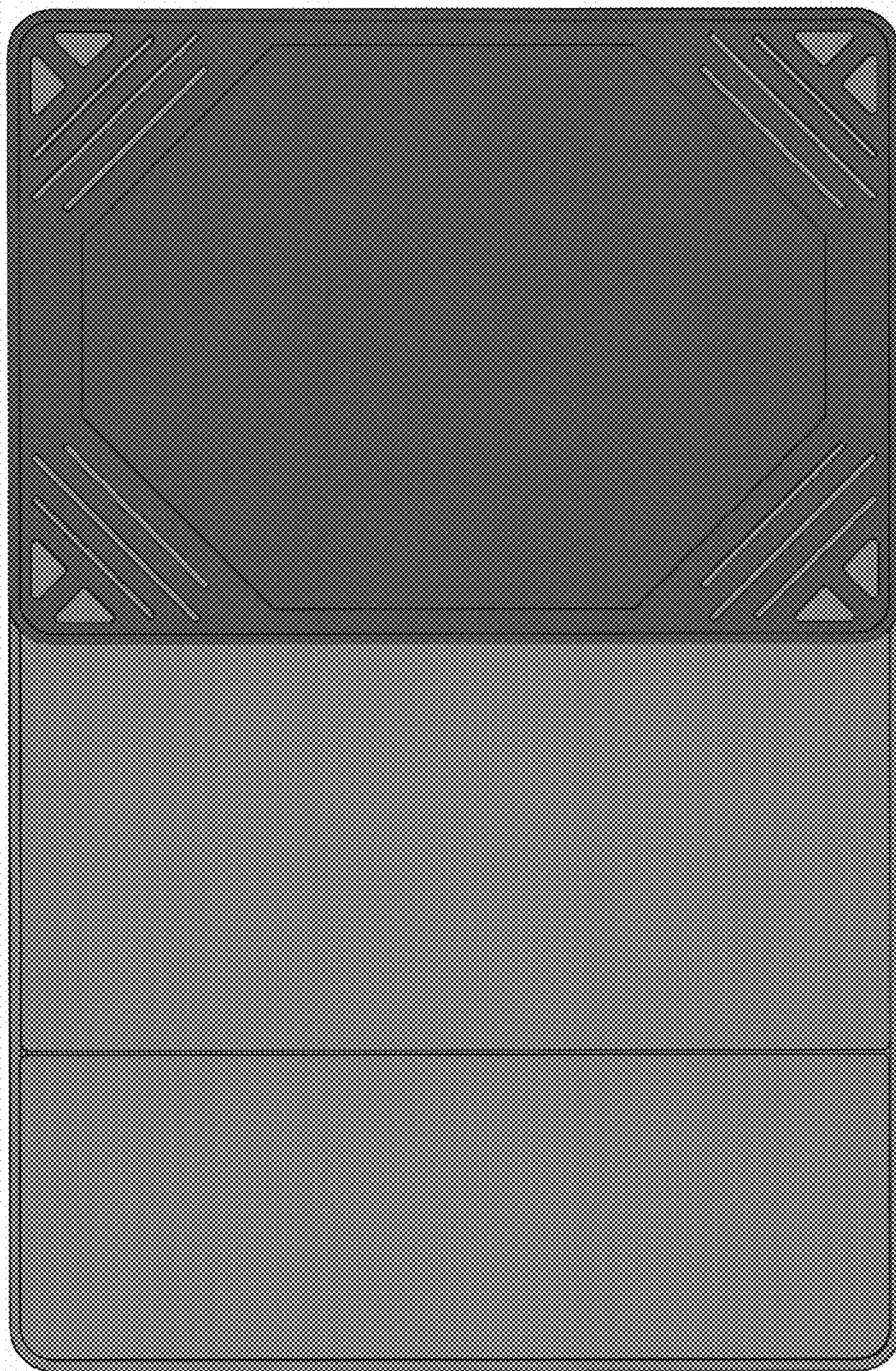

FIG.7

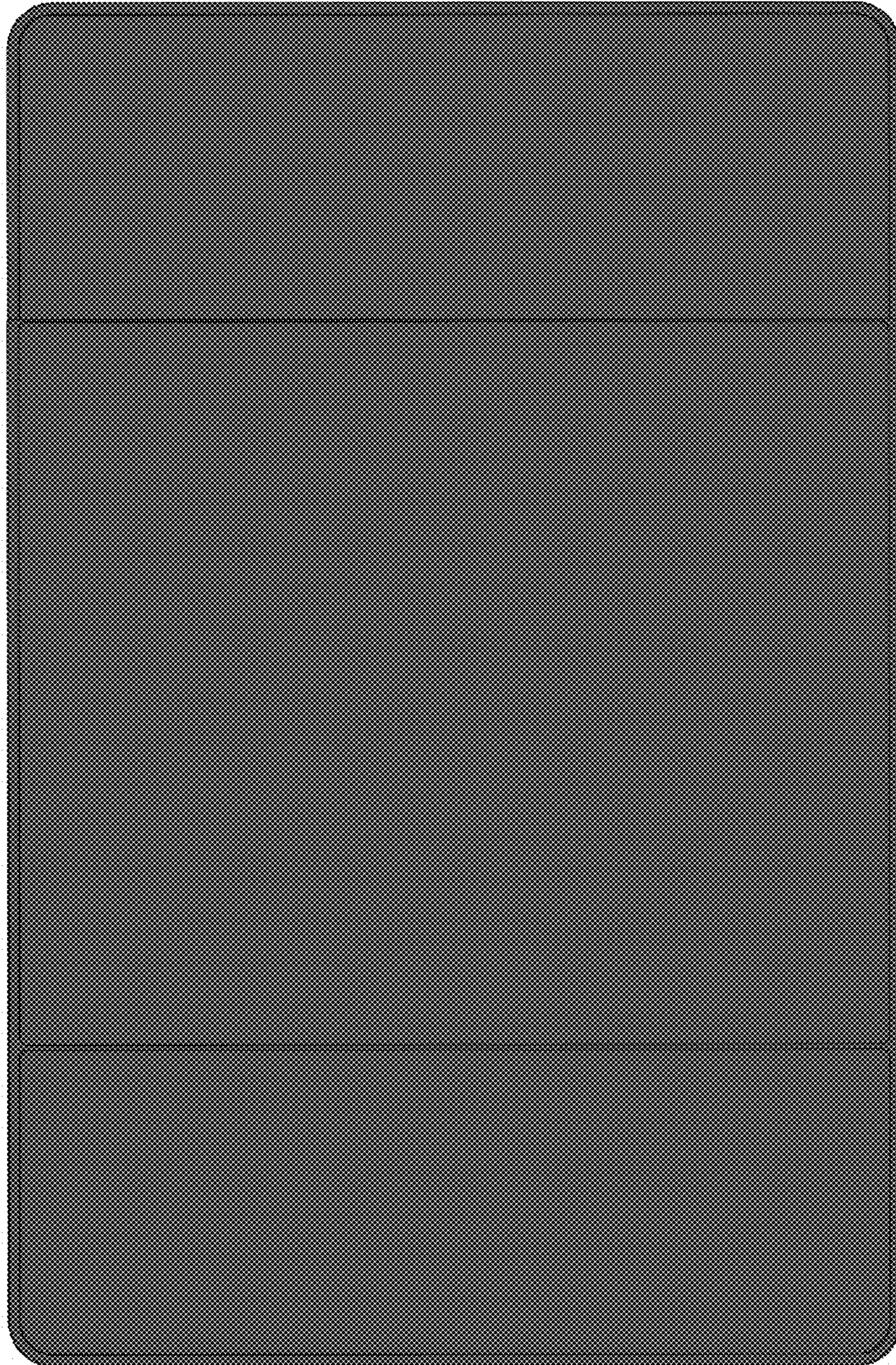

FIG.8

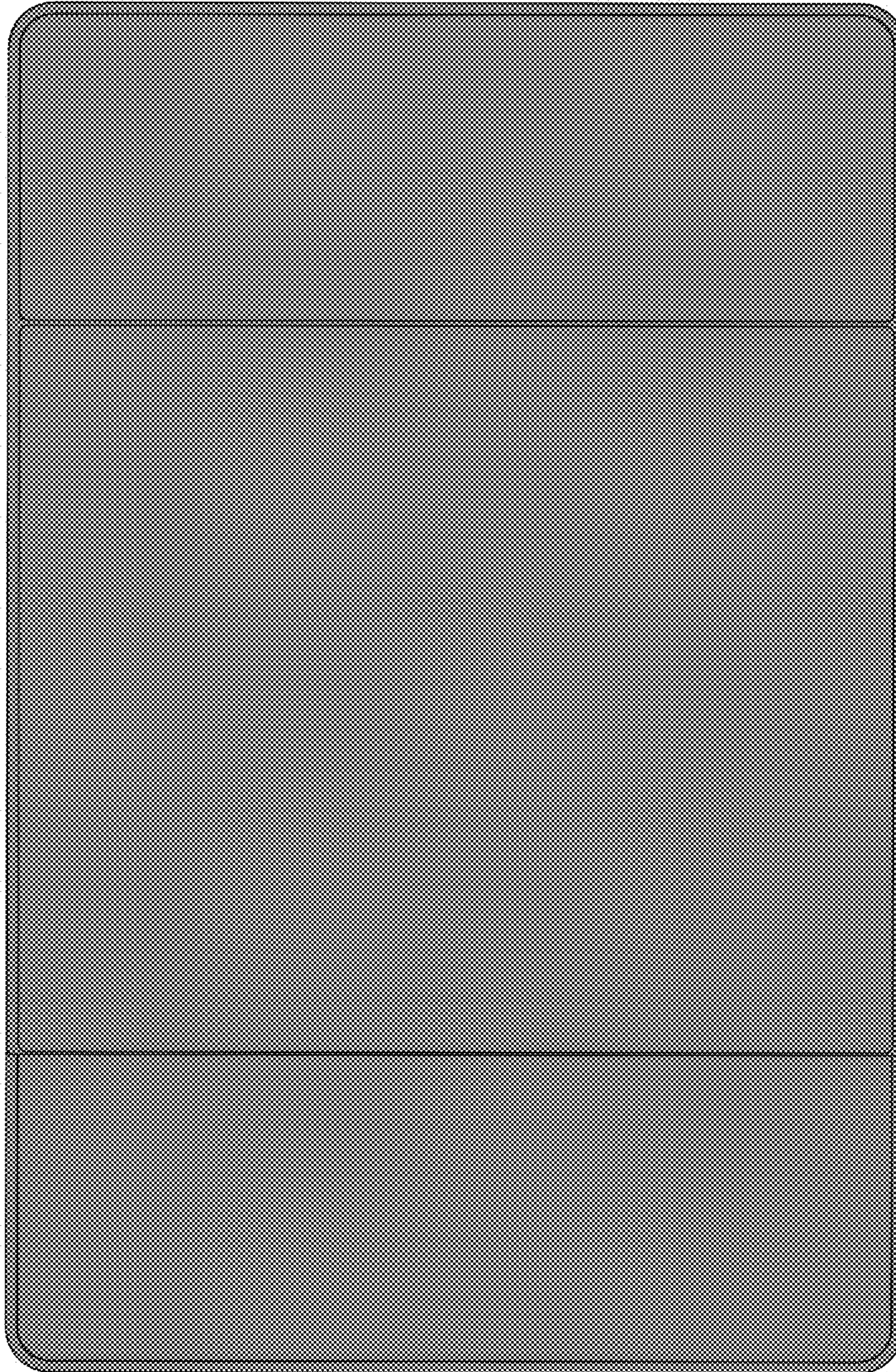

FIG. 9

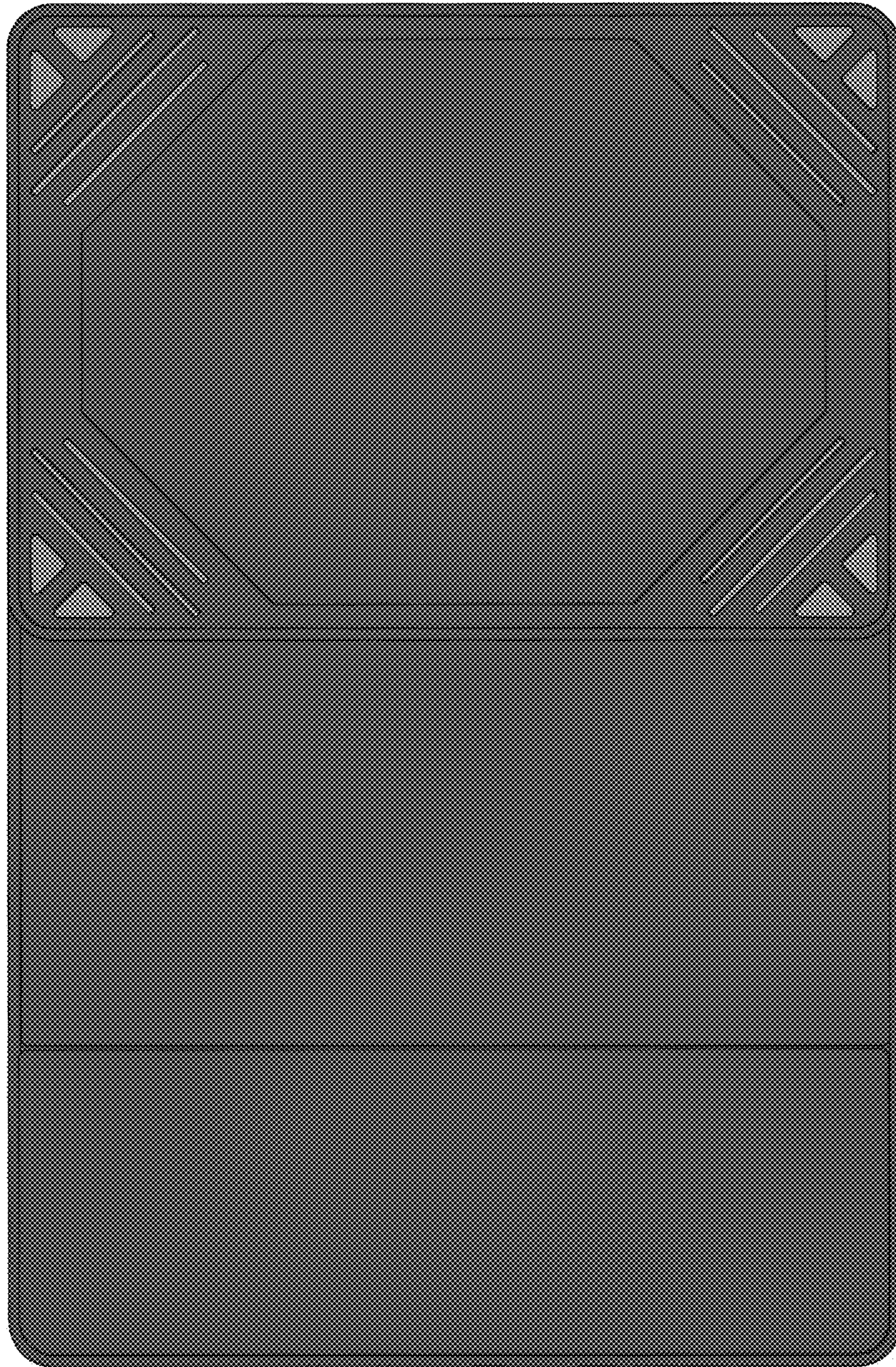

FIG. 10

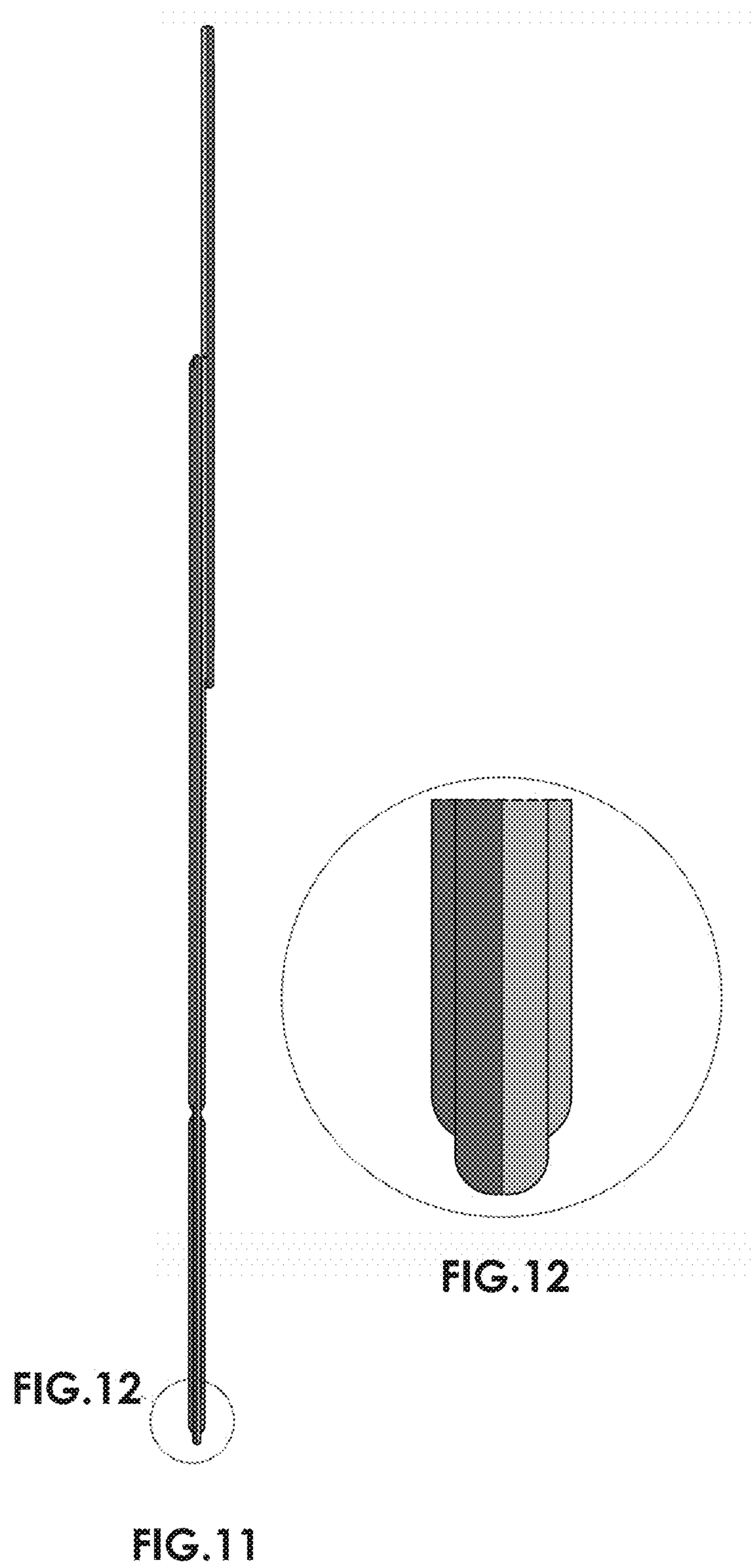



FIG. 13



FIG.14



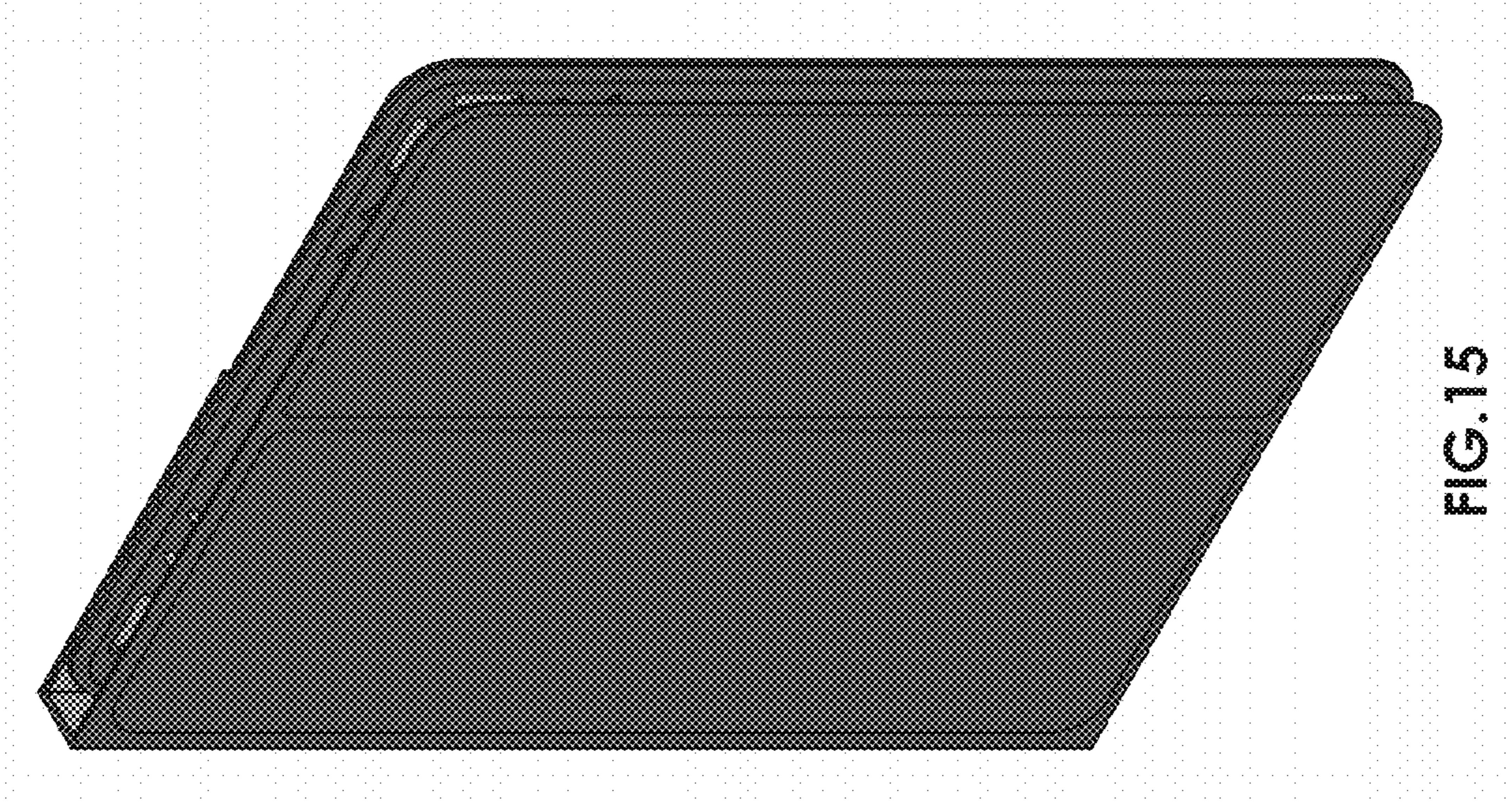

FIG.15

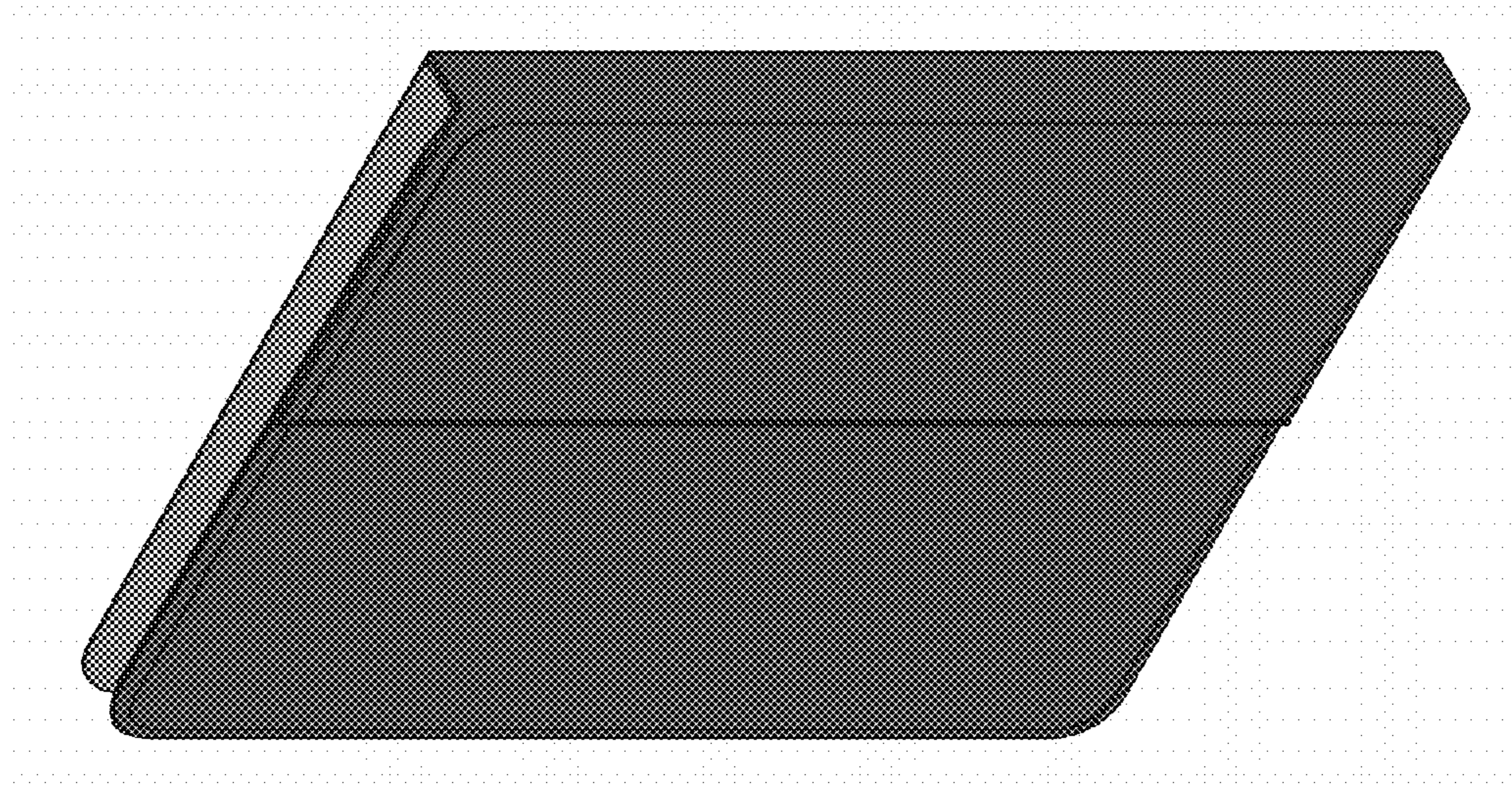

FIG.16



FIG.17

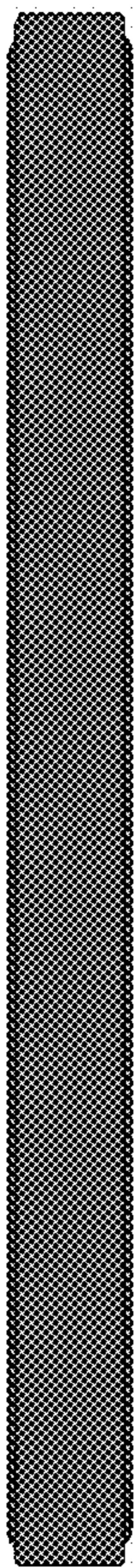

FIG.18

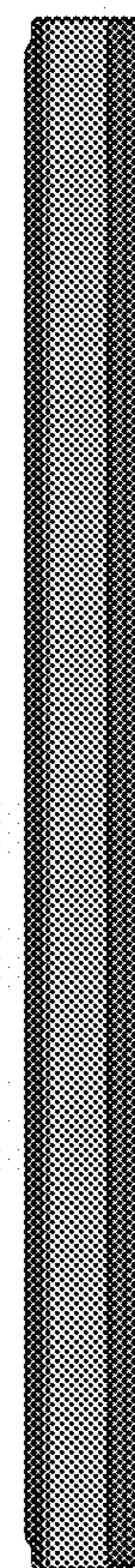

FIG.19



FIG.20

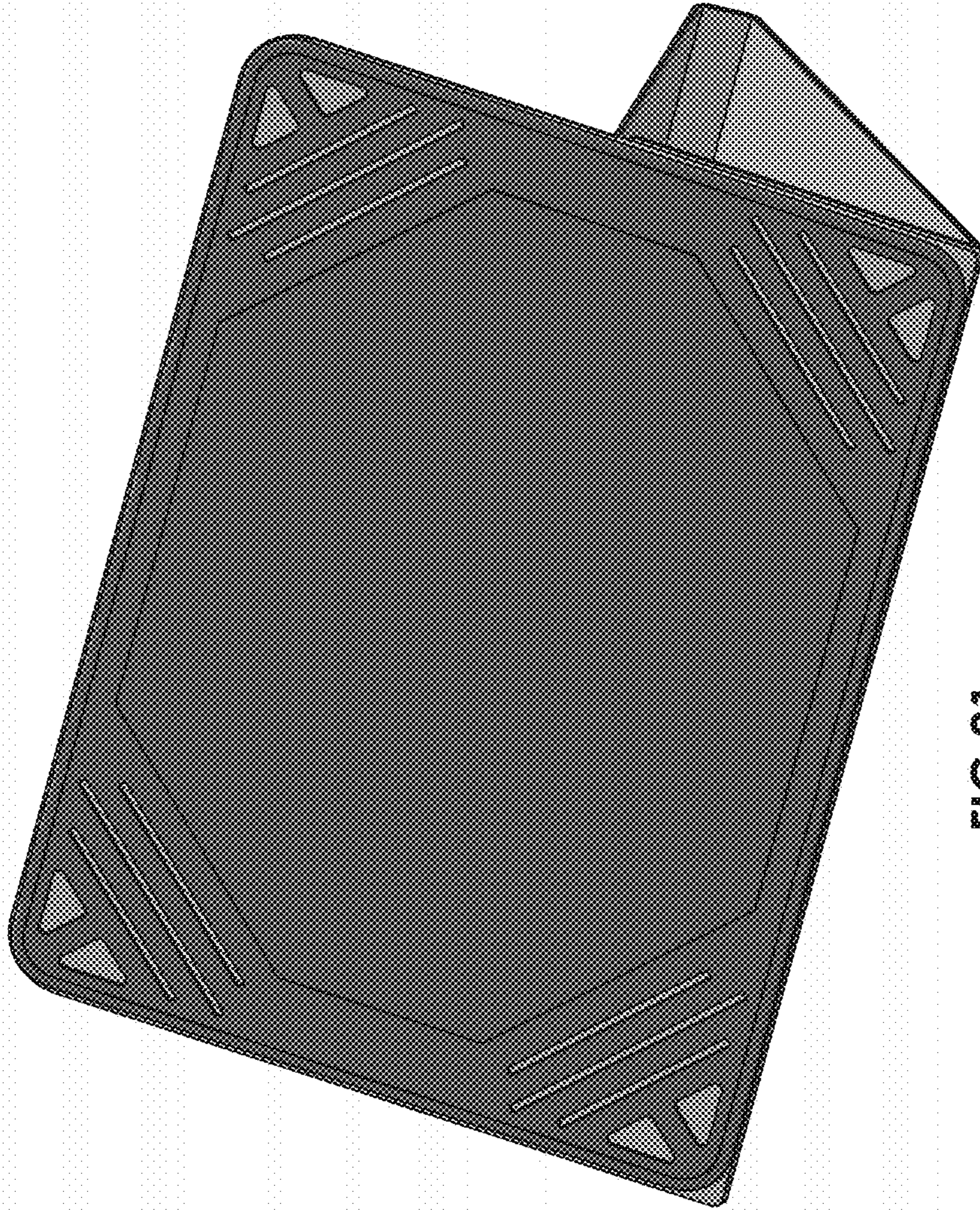

FIG. 21

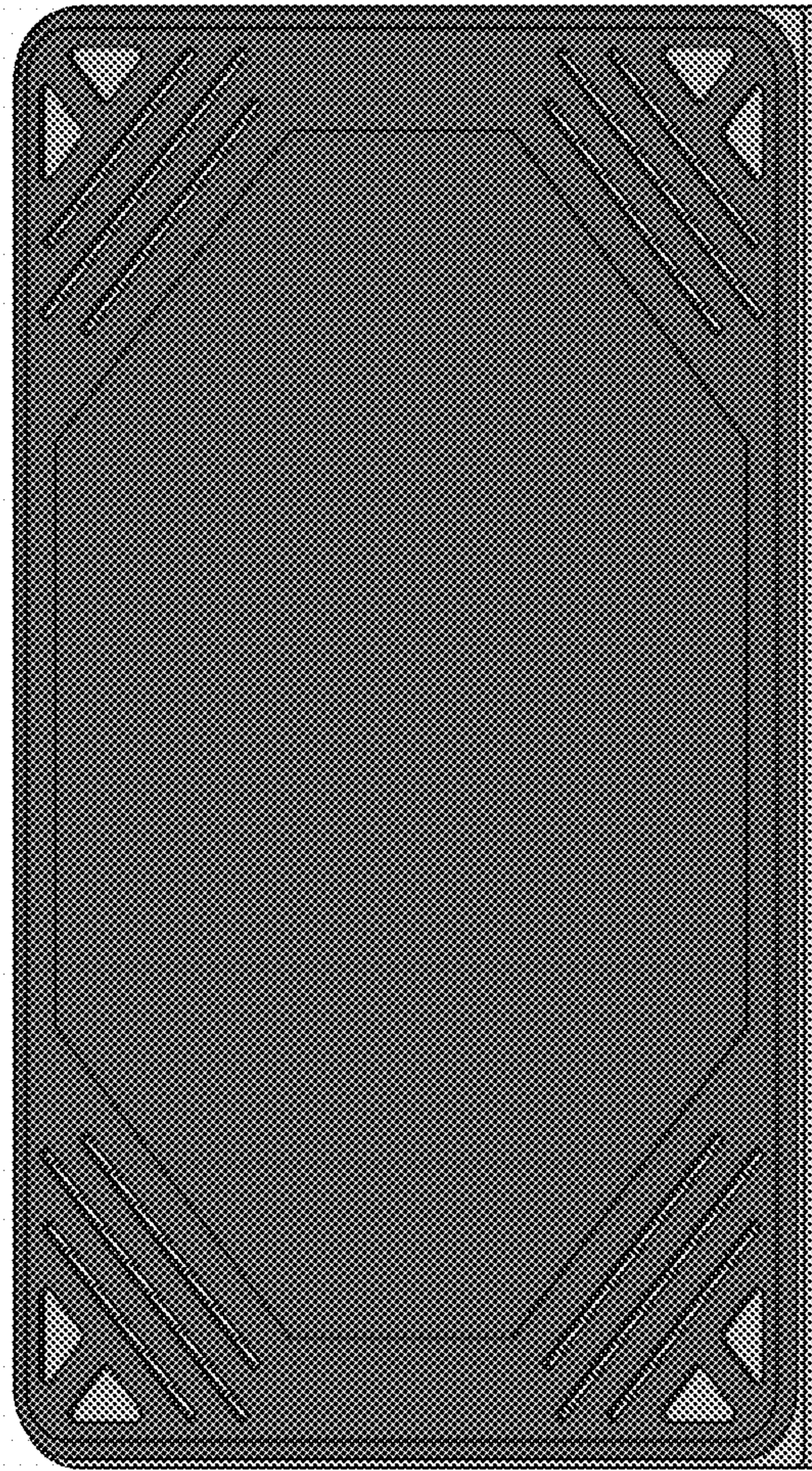

FIG. 22

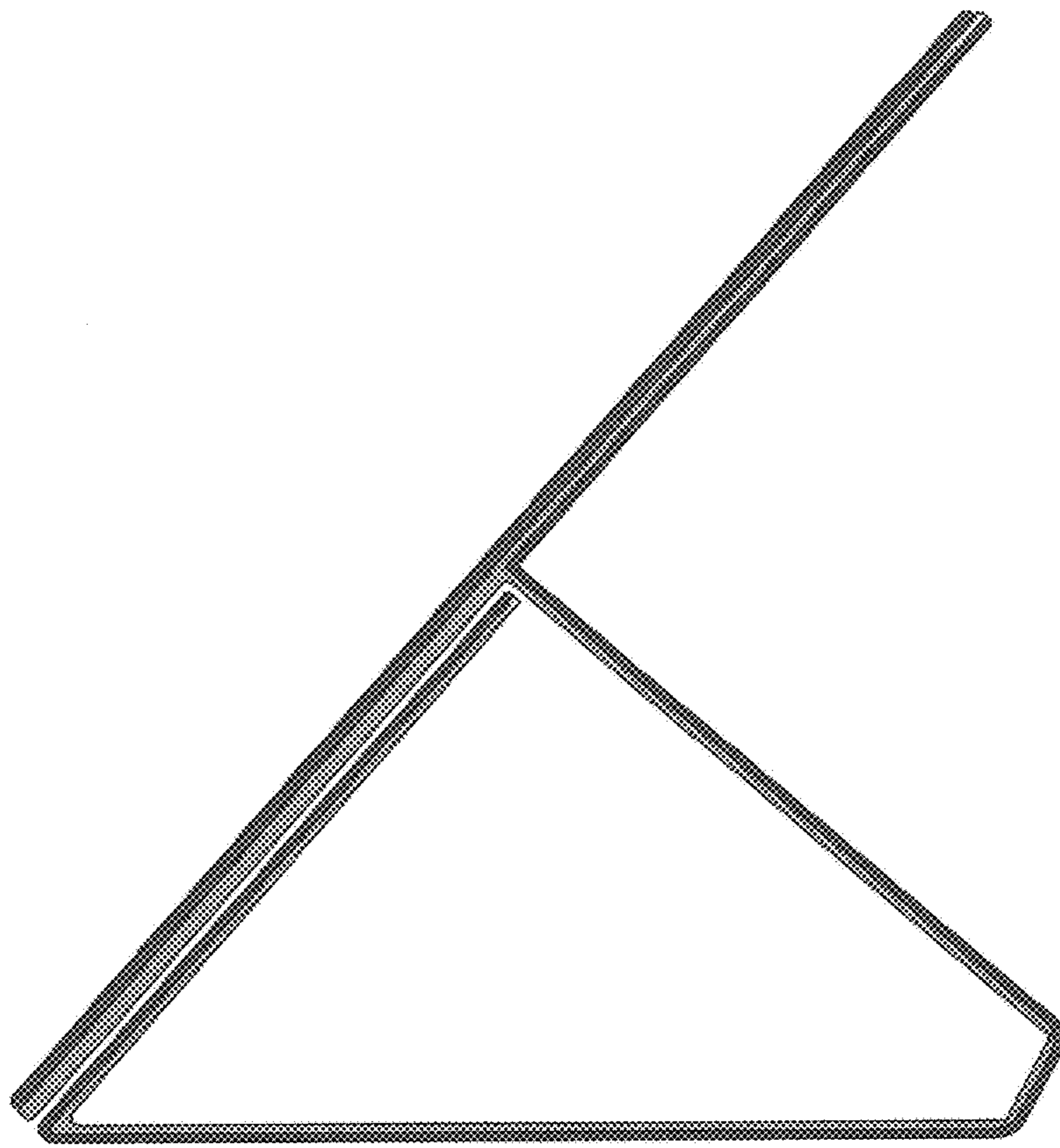

FIG. 23

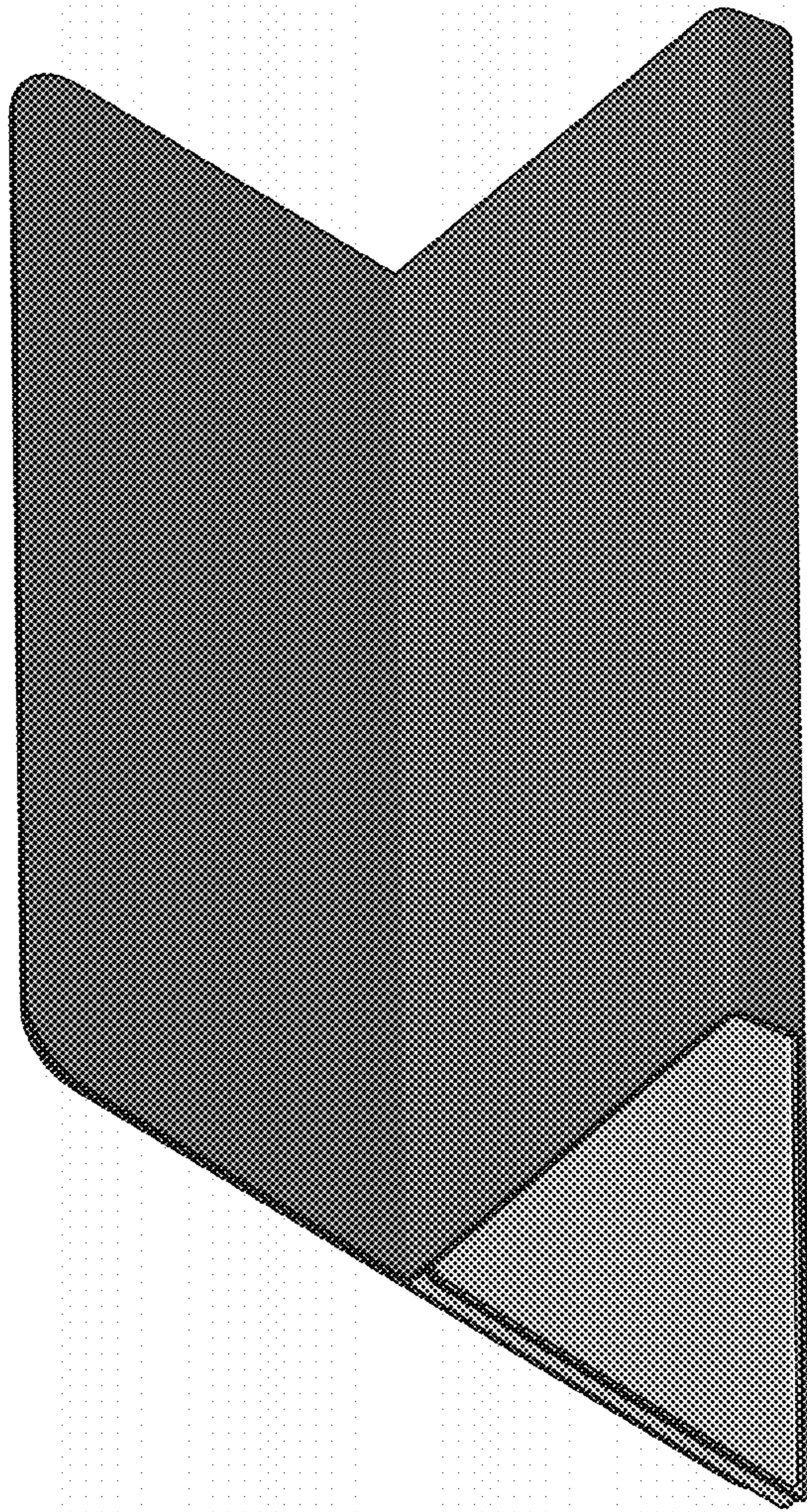

FIG.24

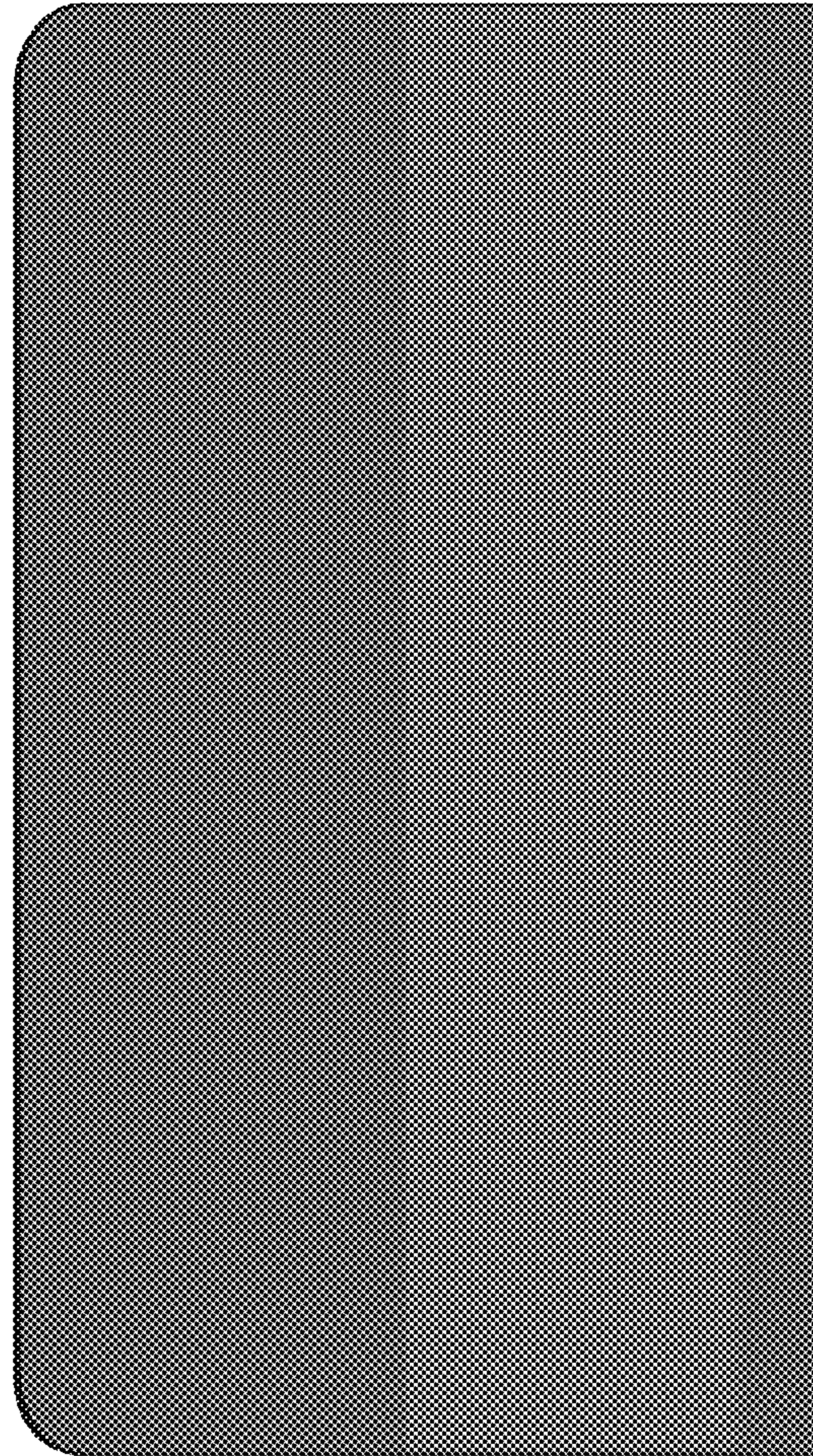

FIG.25



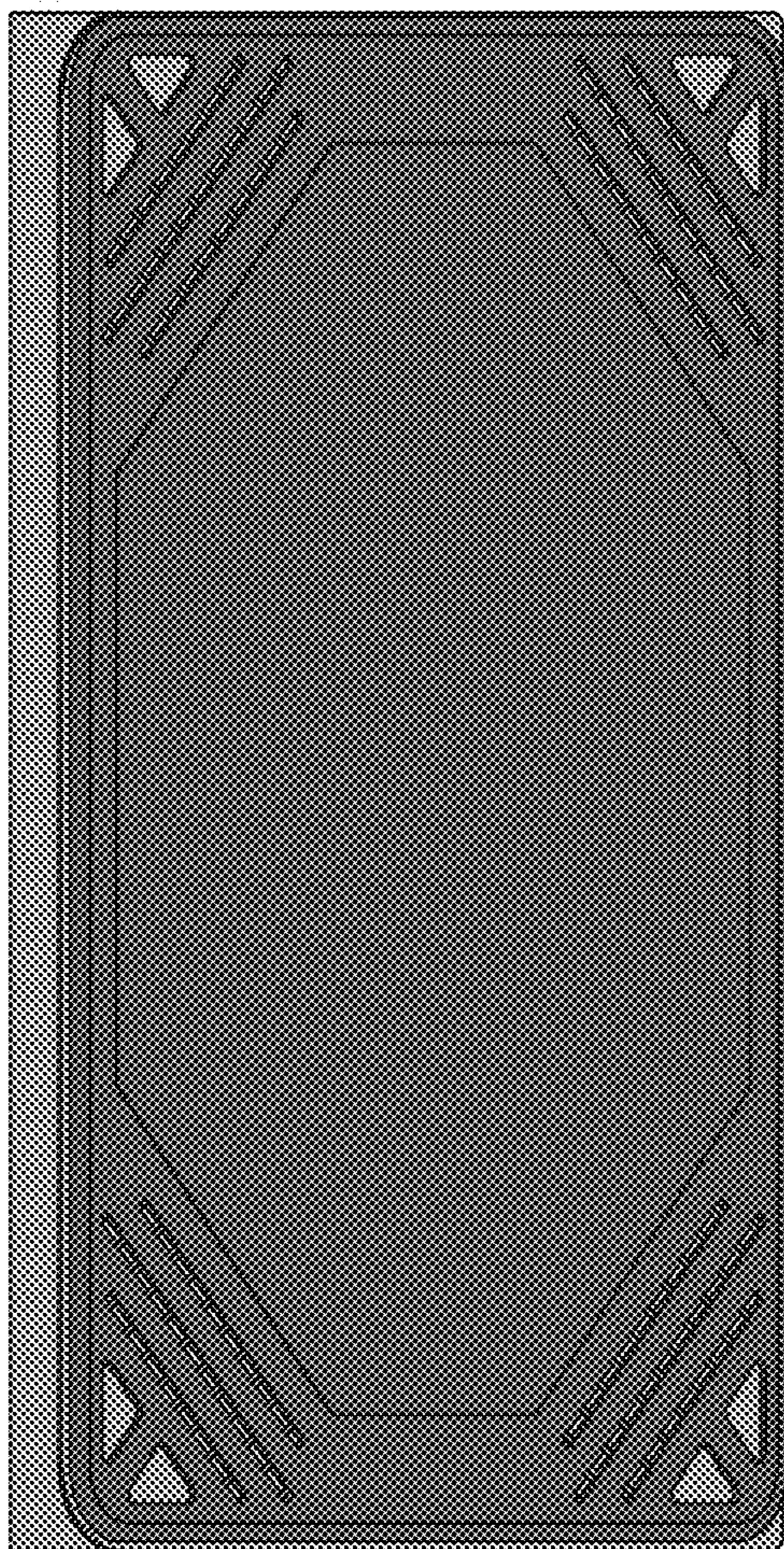

FIG.26

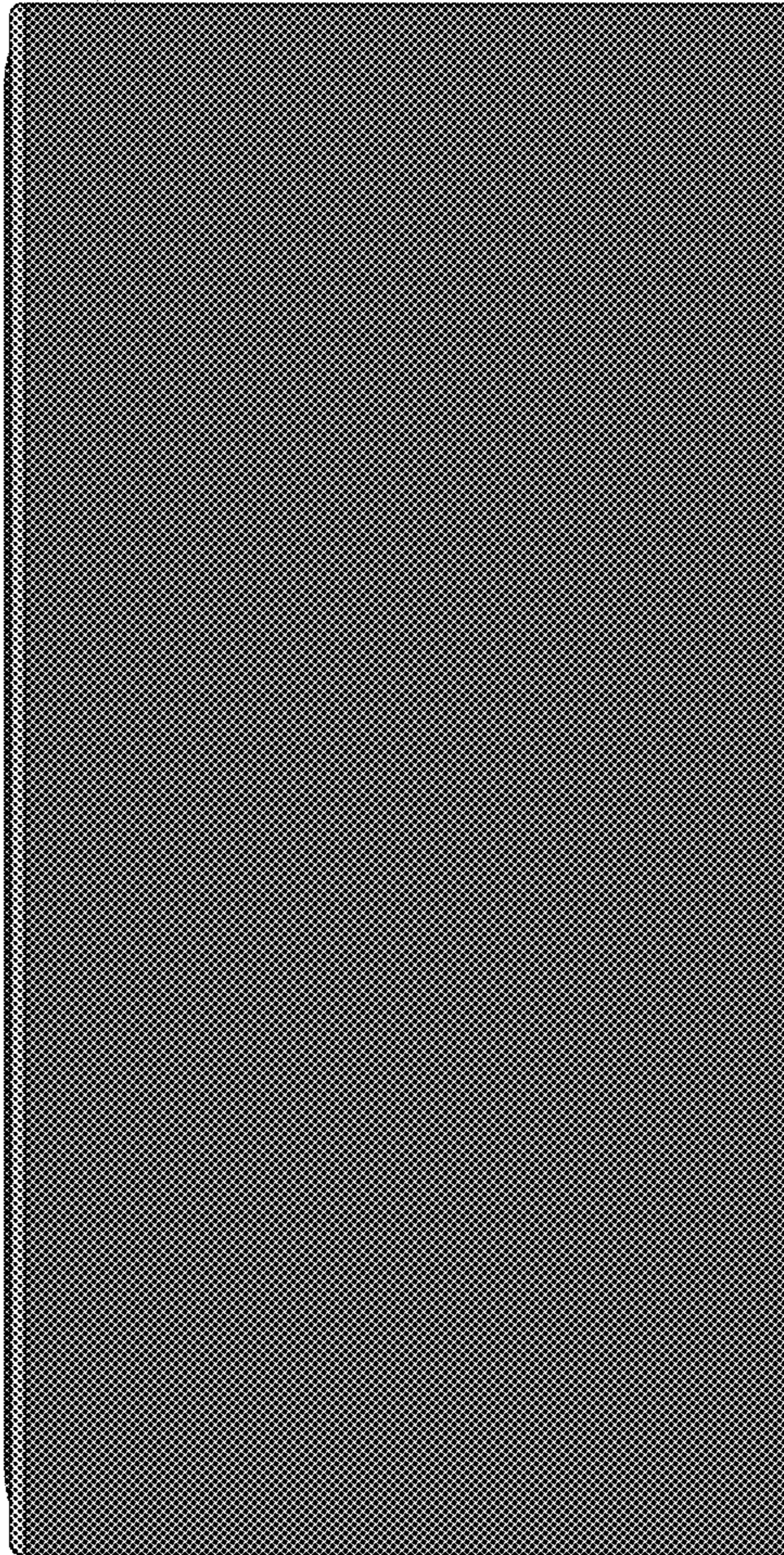

FIG.27