

US00D762186S

(12) **United States Design Patent**
Han et al.

(10) **Patent No.:** **US D762,186 S**
(45) **Date of Patent:** **** Jul. 26, 2016**

(54) **TV RECEIVER**

(71) Applicant: **LG ELECTRONICS INC.**, Seoul (KR)

(72) Inventors: **Youngsoo Han**, Seoul (KR); **Jongho Kim**, Seoul (KR); **Sunha Park**, Seoul (KR); **Youngkyoung Kim**, Seoul (KR); **Nari Lee**, Seoul (KR)

(73) Assignee: **LG ELECTRONICS INC.**, Seoul (KR)

(**) Term: **15 Years**

(21) Appl. No.: **29/529,191**

(22) Filed: **Jun. 4, 2015**

(30) **Foreign Application Priority Data**

Dec. 5, 2014 (KR) 30-2014-0059290

(51) **LOC (10) Cl.** **14-03**

(52) **U.S. Cl.**
USPC **D14/126**

(58) **Field of Classification Search**
USPC D14/125-134, 239, 371, 136, 374-377, D14/440, 450, 448, 336, 342, 159; 312/7.2; 348/836, 838, 180, 184, 325, 739; 248/917-924, 465; 345/104, 133, 156, 345/168, 87, 173; D21/329, 515, 577, 622, D21/333, 433, 448, 452, 450, 331, 505; D10/15, 26; 446/484, 175, 356; D6/477, 479, 300; D20/10, 19, 39
CPC ... G06F 1/1601; G06F 1/1643; H05K 5/0004; H05K 5/0017; H05K 5/02; H05K 5/0217; H04M 13/0459

See application file for complete search history.

(56) **References Cited**

U.S. PATENT DOCUMENTS

D436,629 S * 1/2001 Fawkes D14/128
D490,063 S * 5/2004 Miller D14/126

(Continued)

Primary Examiner — Raphael Barkai

(74) *Attorney, Agent, or Firm* — Birch, Stewart, Kolasch & Birch, LLP

(57) **CLAIM**

The ornamental design for a TV receiver, as shown and described.

DESCRIPTION

FIG. 1 is a front, right side, perspective view of a TV receiver showing our new design;
FIG. 2 is a front view thereof;
FIG. 3 is a rear view thereof;
FIG. 4 is a left side view thereof;
FIG. 5 is a right side view thereof;
FIG. 6 is a top view thereof;
FIG. 7 is a bottom view thereof;
FIG. 8 is a rear, right side, perspective view thereof.
FIG. 9 is a front, right side, perspective view with its front display sliding up slightly, thereof;
FIG. 10 is a front view with its front display sliding up slightly thereof;
FIG. 11 is a rear view with its front display sliding up slightly thereof;
FIG. 12 is a left side view with its front display sliding up slightly thereof;
FIG. 13 is a right side view with its front display sliding up slightly thereof;
FIG. 14 is a top view with its front display sliding up slightly thereof;
FIG. 15 is a bottom view with its front display sliding up slightly thereof;
FIG. 16 is a front, right side, perspective view with its front display sliding up fully thereof;
FIG. 17 is a front view with its front display sliding up fully thereof;
FIG. 18 is a rear view with its front display sliding up fully thereof;
FIG. 19 is a left side view with its front display sliding up fully thereof;
FIG. 20 is a right side view with its front display sliding up fully thereof;
FIG. 21 is a top view with its front display sliding up fully thereof; and,
FIG. 22 is a bottom view with its front display sliding up fully thereof.
The broken lines indicate unclaimed portion of the article that form no part of the claimed design.

1 Claim, 17 Drawing Sheets

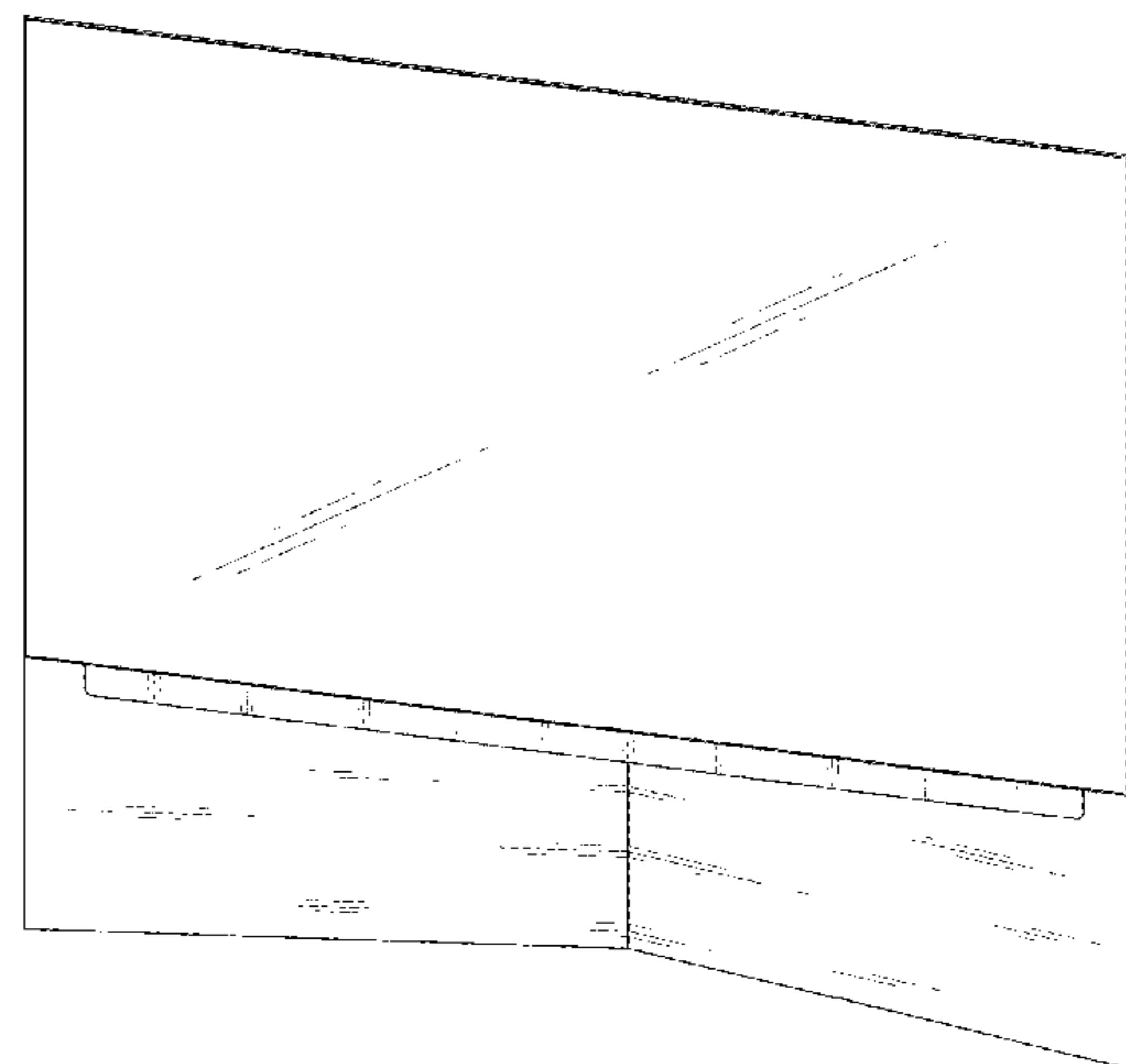
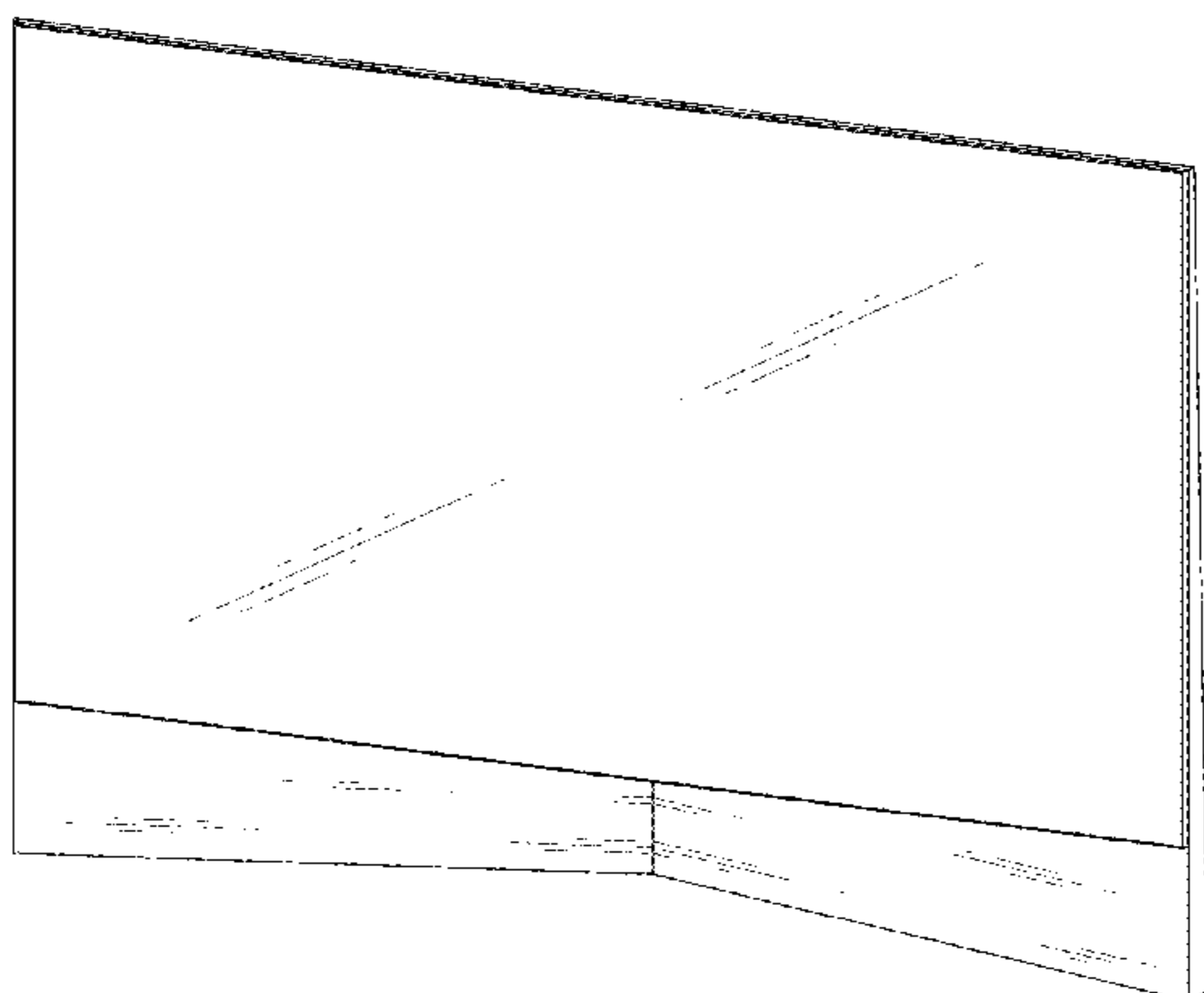

(56)

References Cited

U.S. PATENT DOCUMENTS

D503,391 S * 3/2005 Kato D14/126
D514,536 S * 2/2006 Villalobos D14/128
D515,048 S * 2/2006 Villalobos D14/128
D572,214 S * 7/2008 Lewis D14/126
D650,764 S * 12/2011 Chiu D14/126
D661,123 S * 6/2012 Curbun D20/10

D692,844 S * 11/2013 Seong D14/126
D712,367 S * 9/2014 Park D14/126
D718,263 S * 11/2014 Kim D14/126
D719,120 S * 12/2014 Park D14/126
D736,168 S * 8/2015 Kim D14/126
D736,169 S * 8/2015 Kim D14/126
D737,235 S * 8/2015 Kim D14/126
D744,446 S * 12/2015 Kim D14/126

* cited by examiner

FIG. 1

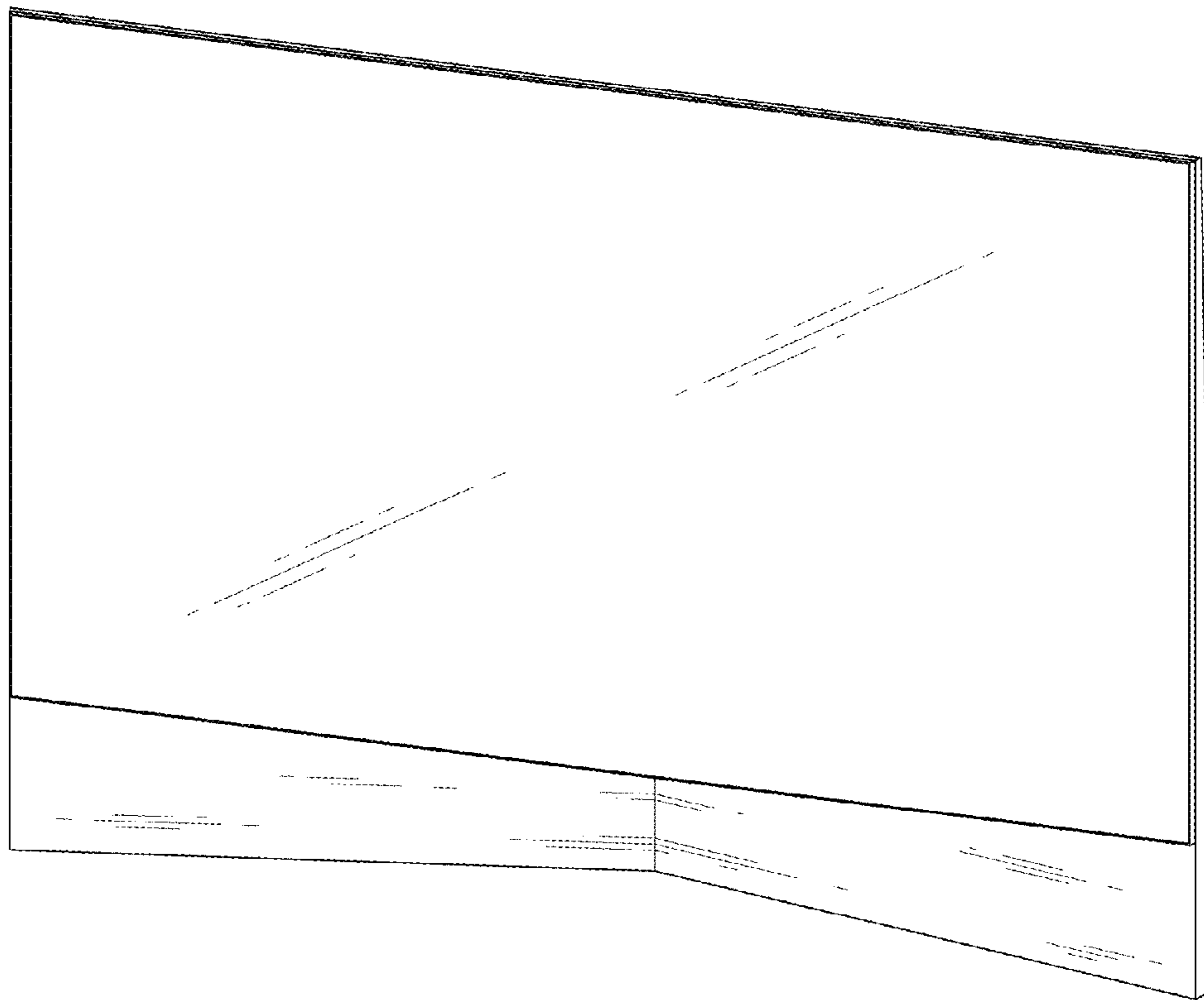

FIG. 2

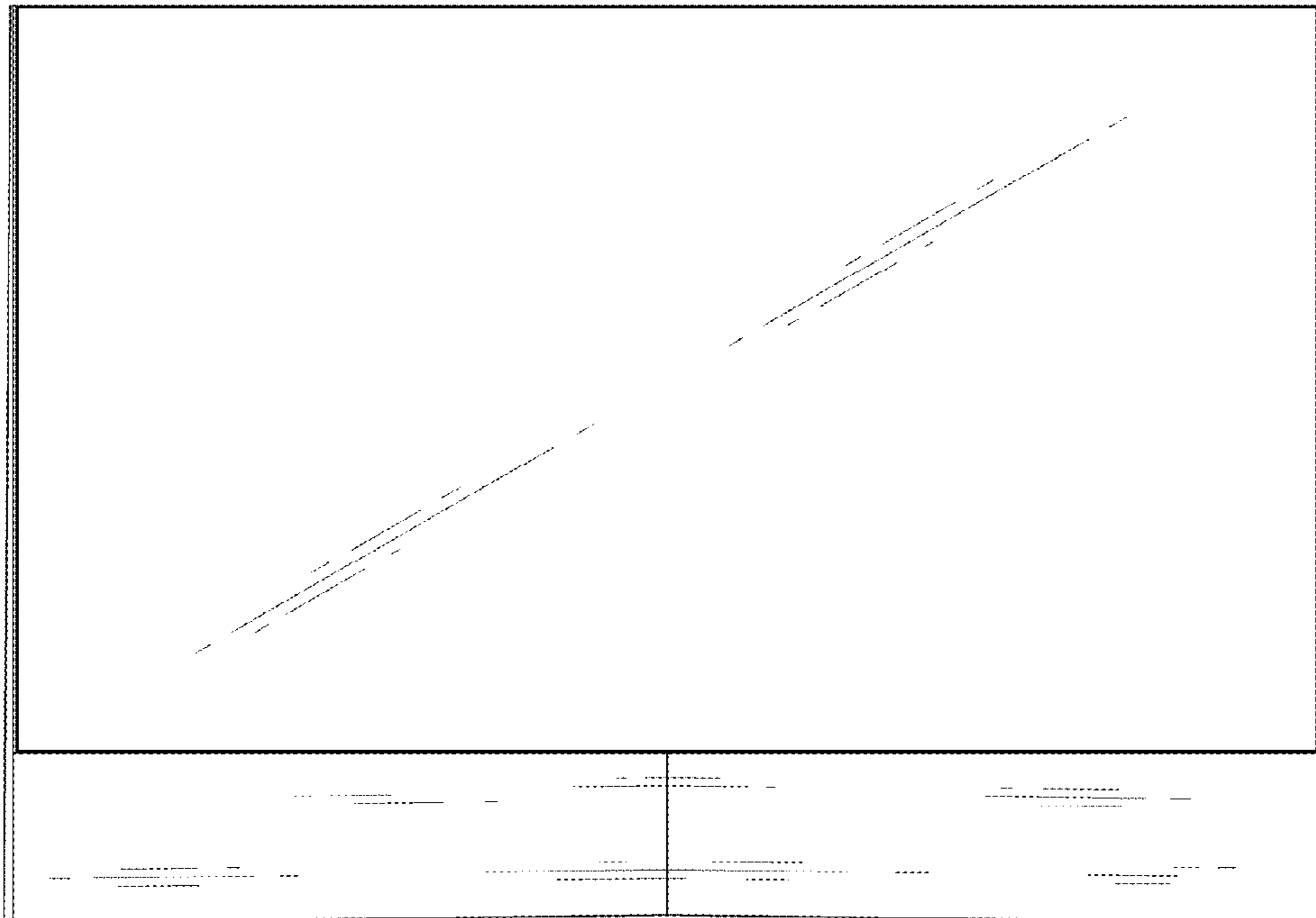

FIG. 3

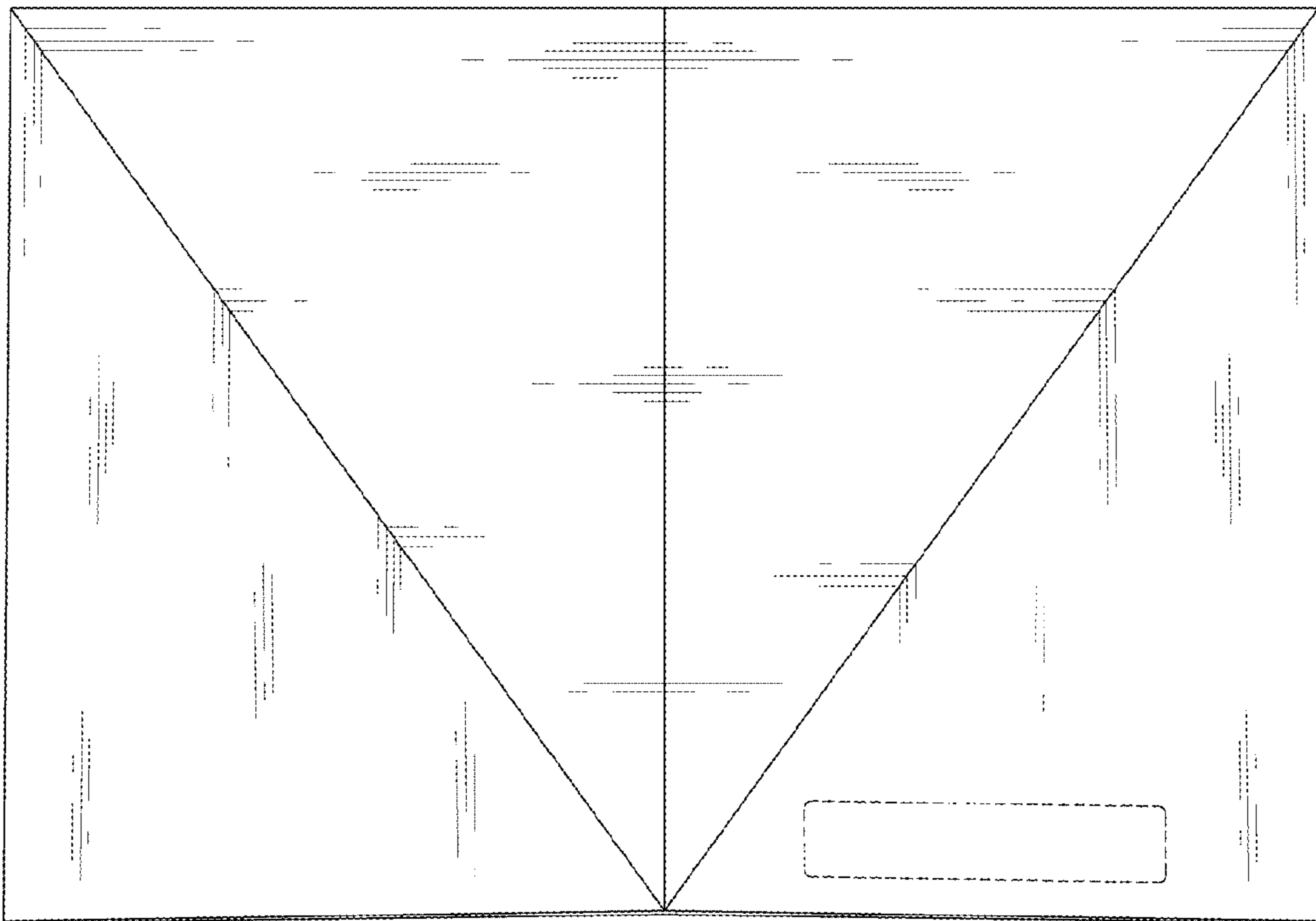

FIG. 4

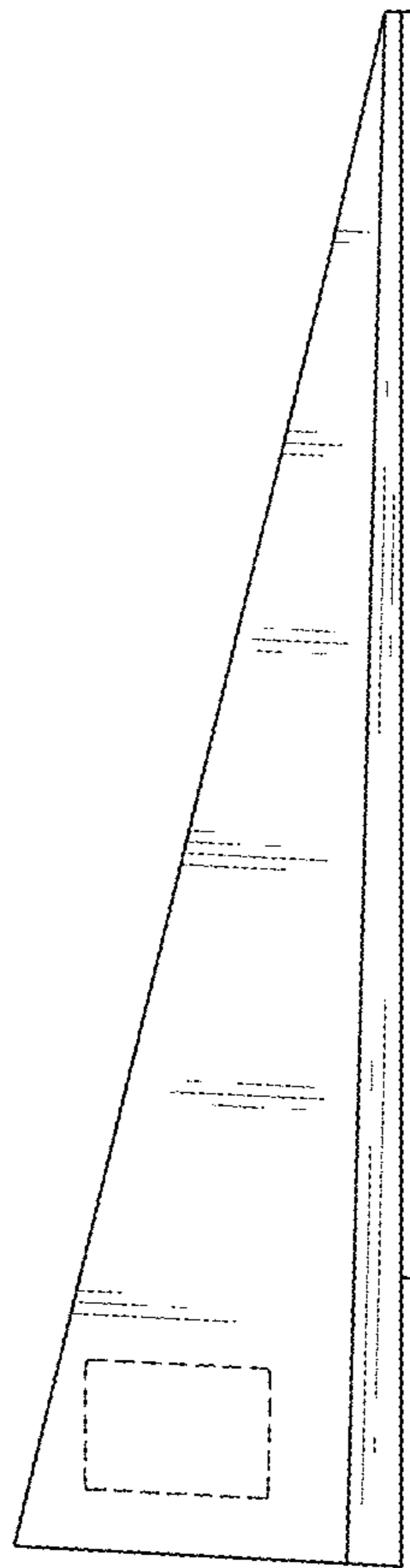

FIG. 5

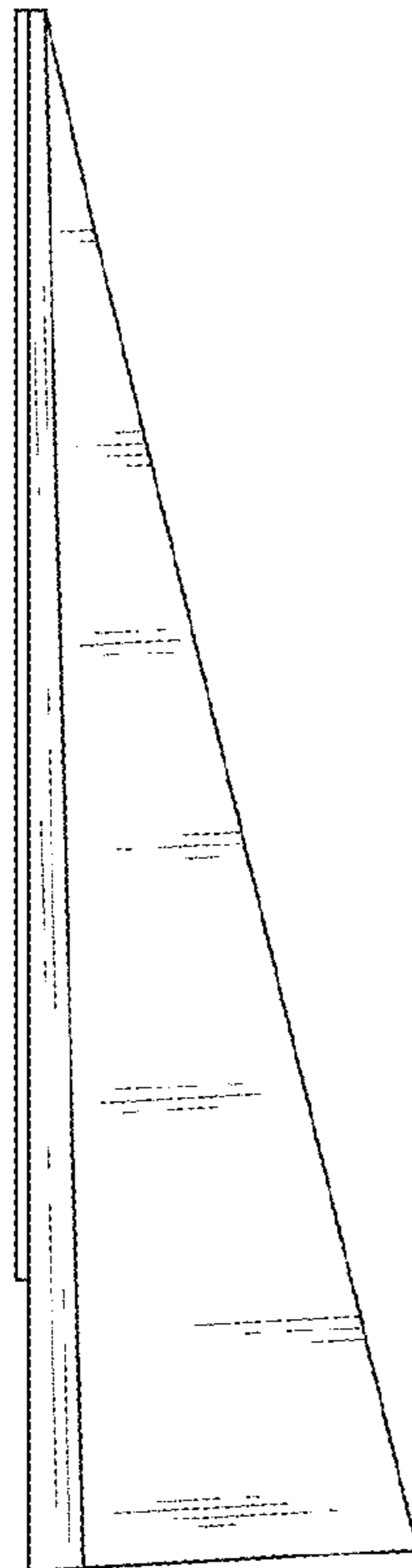

FIG. 6

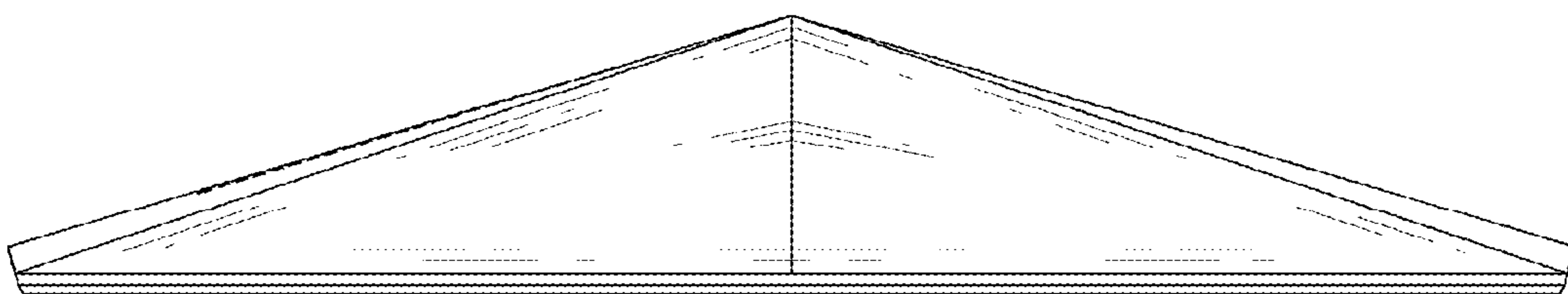

FIG. 7

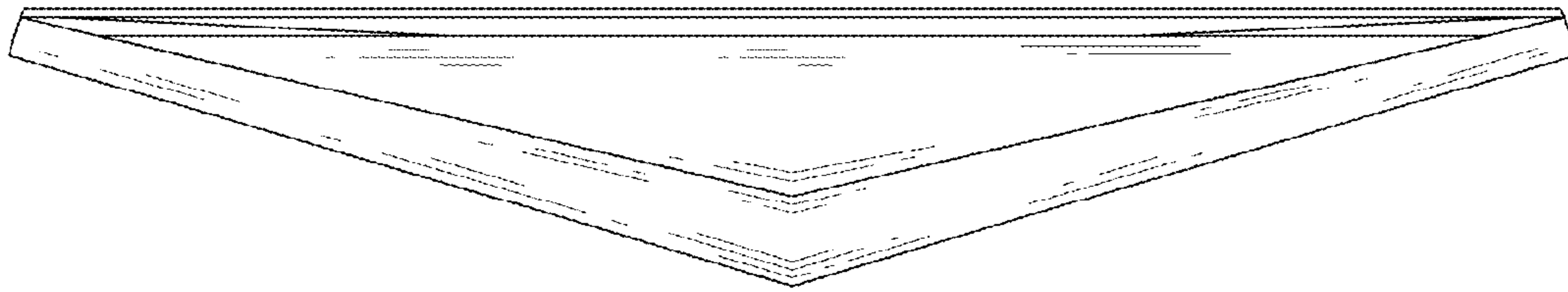

FIG. 8

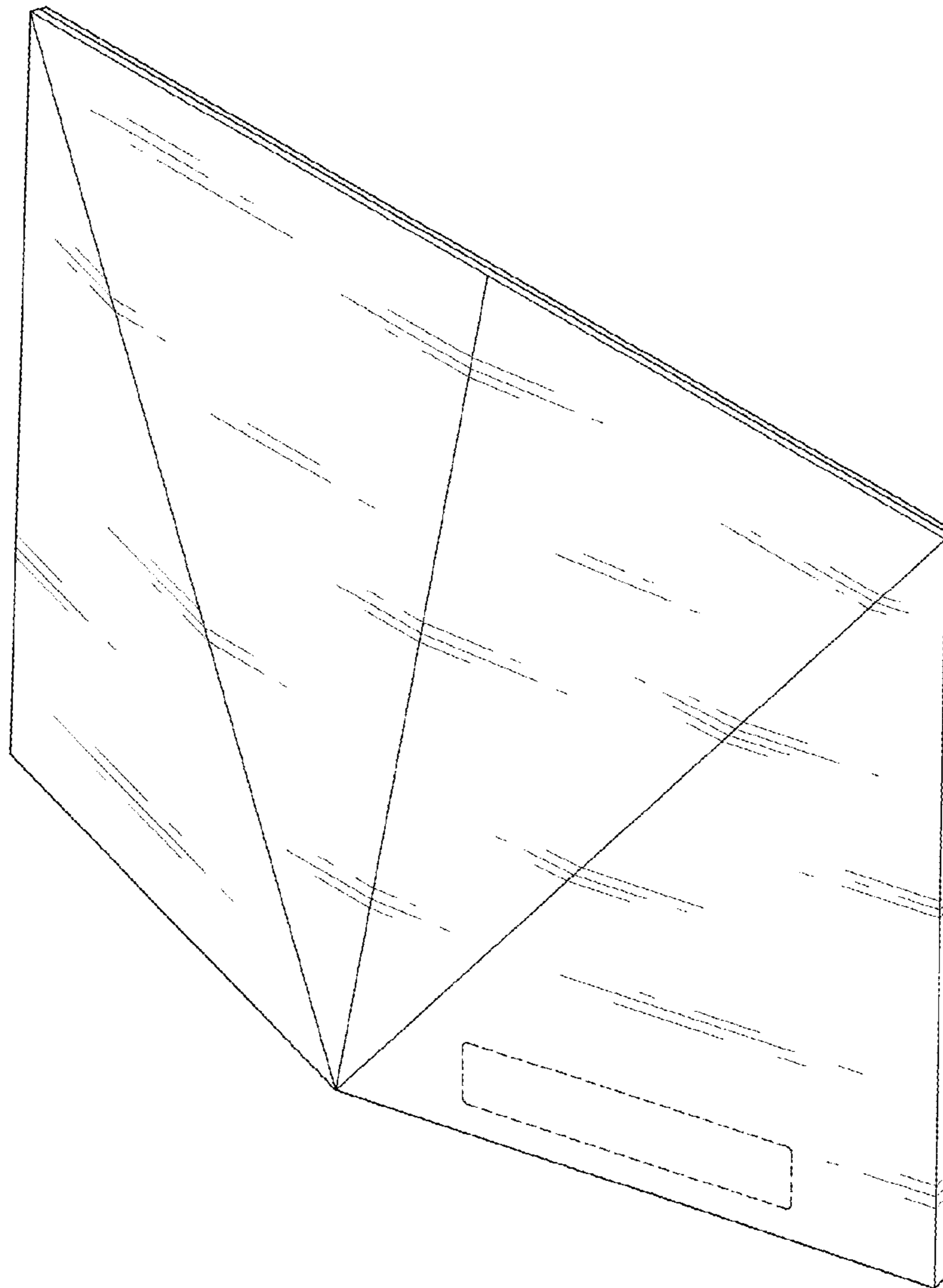

FIG. 9

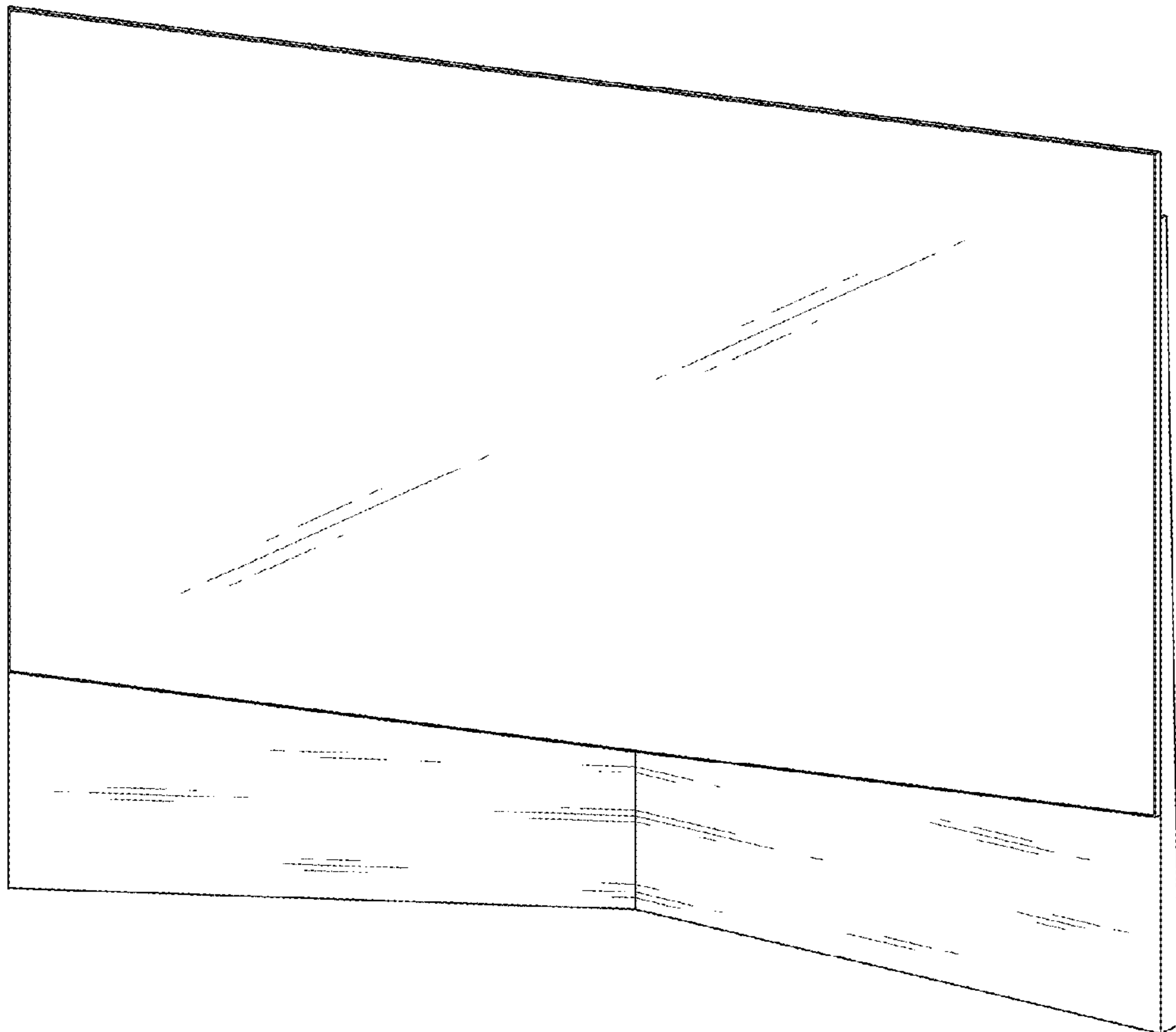

FIG. 10

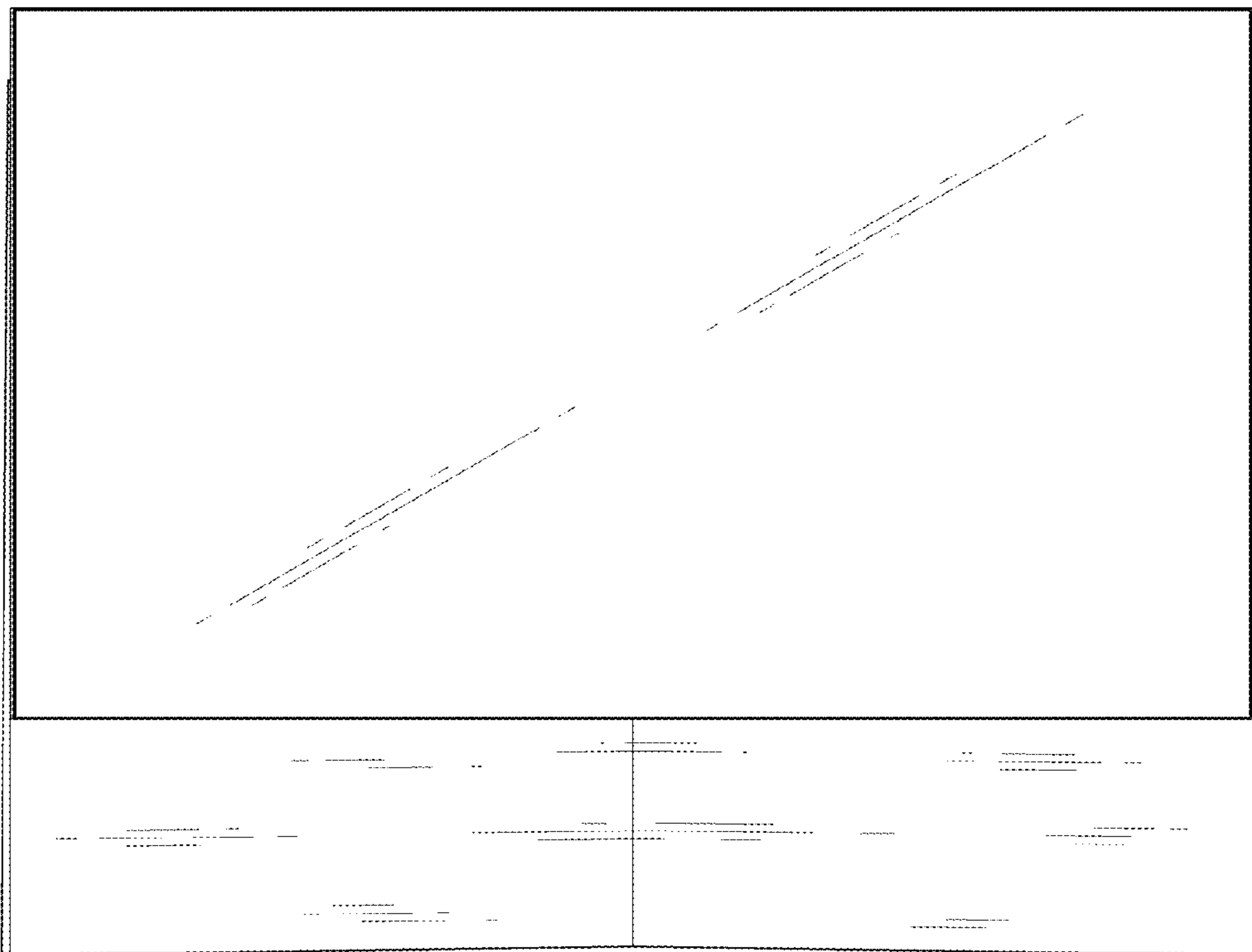

FIG.11

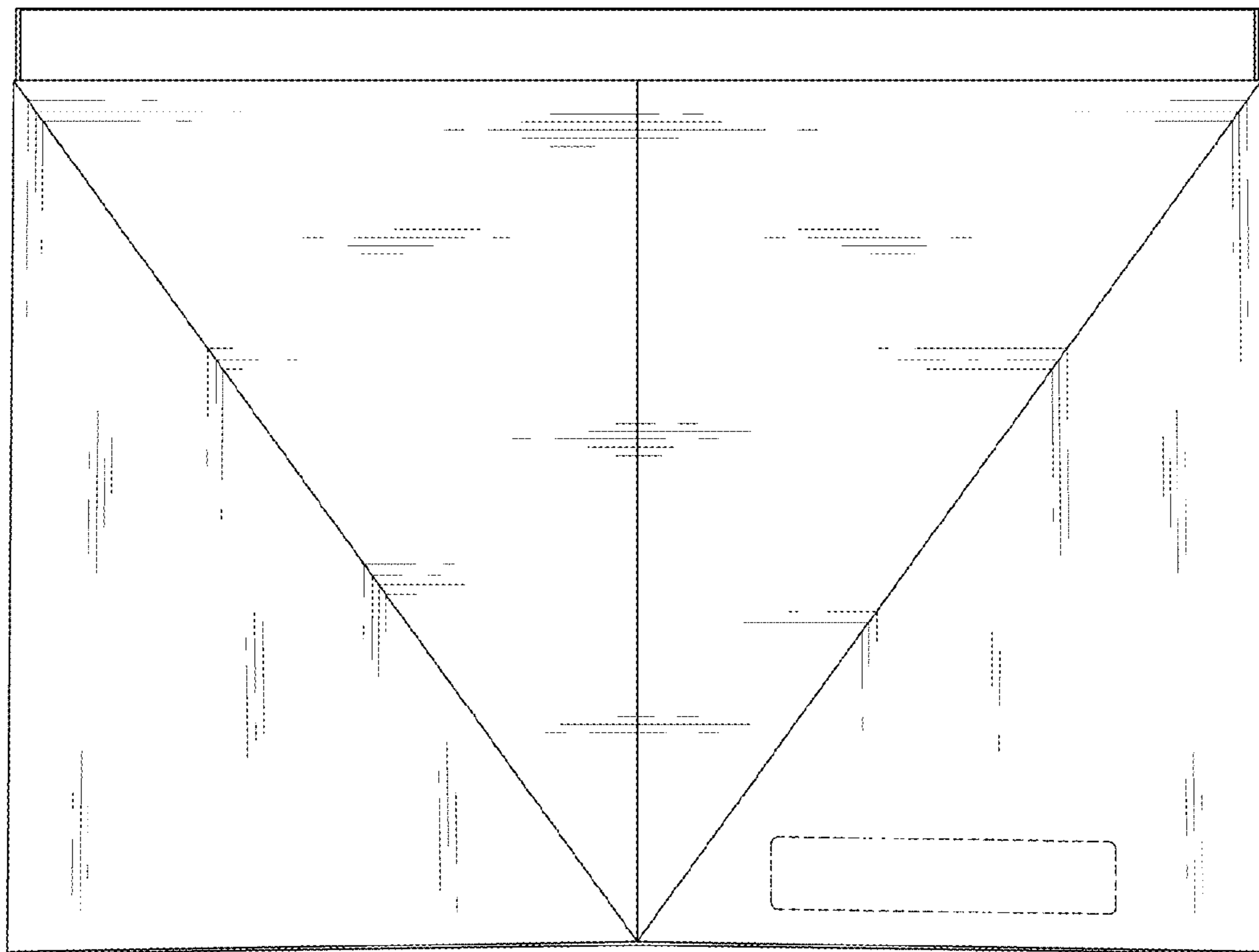

FIG. 12

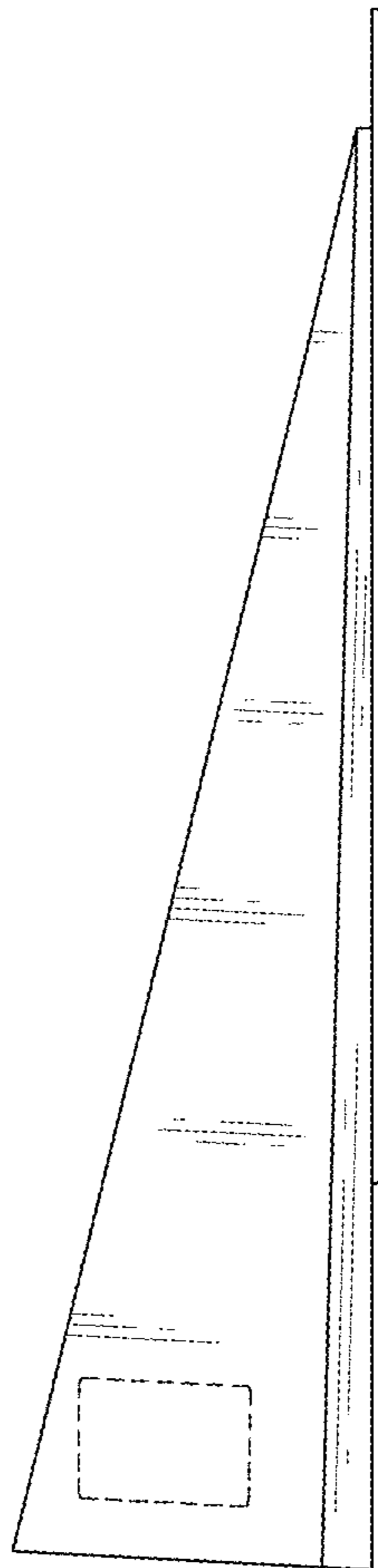

FIG. 13

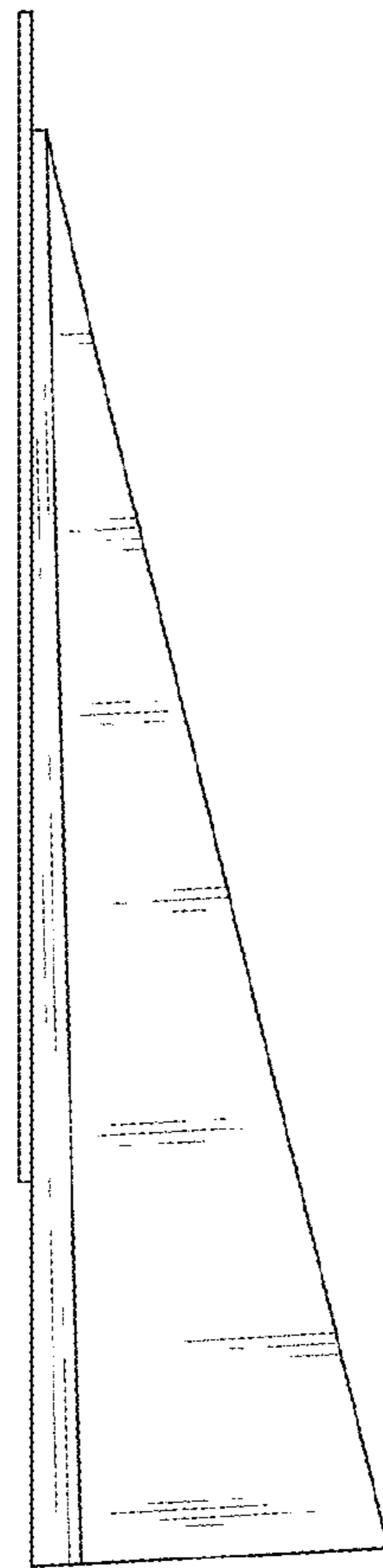

FIG. 14

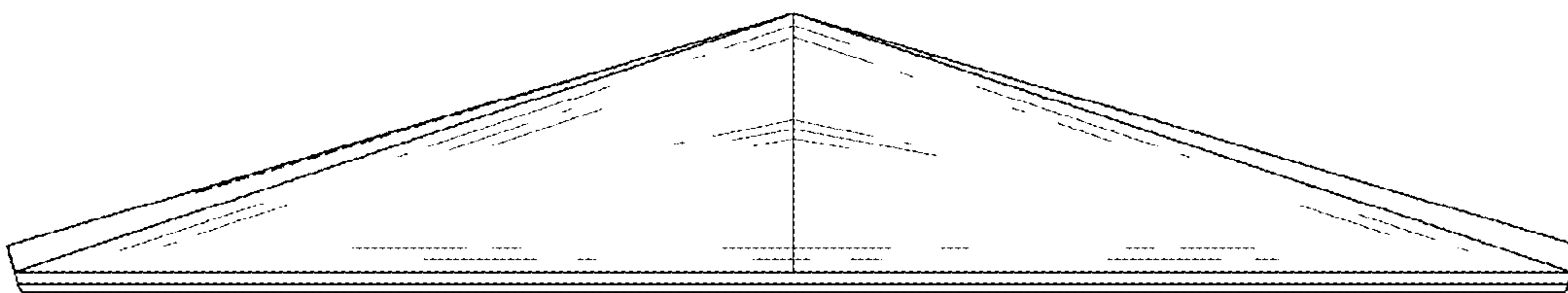

FIG. 15

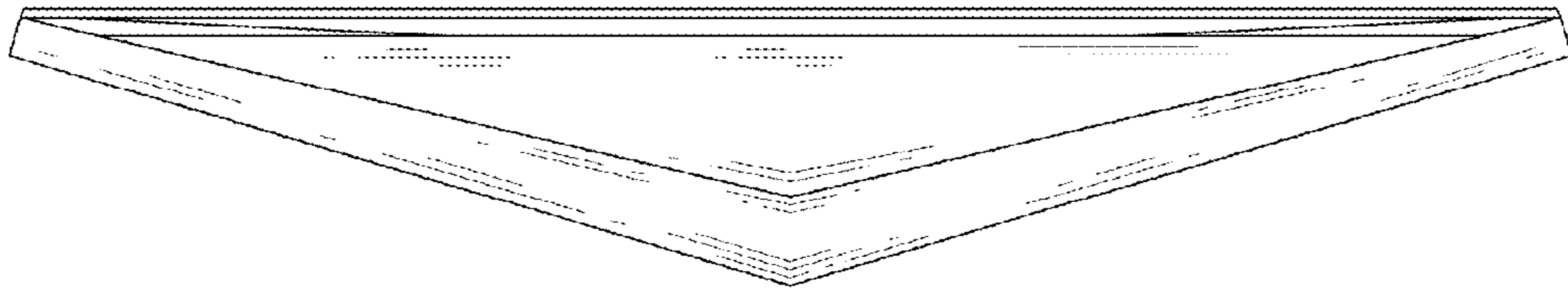

FIG. 16

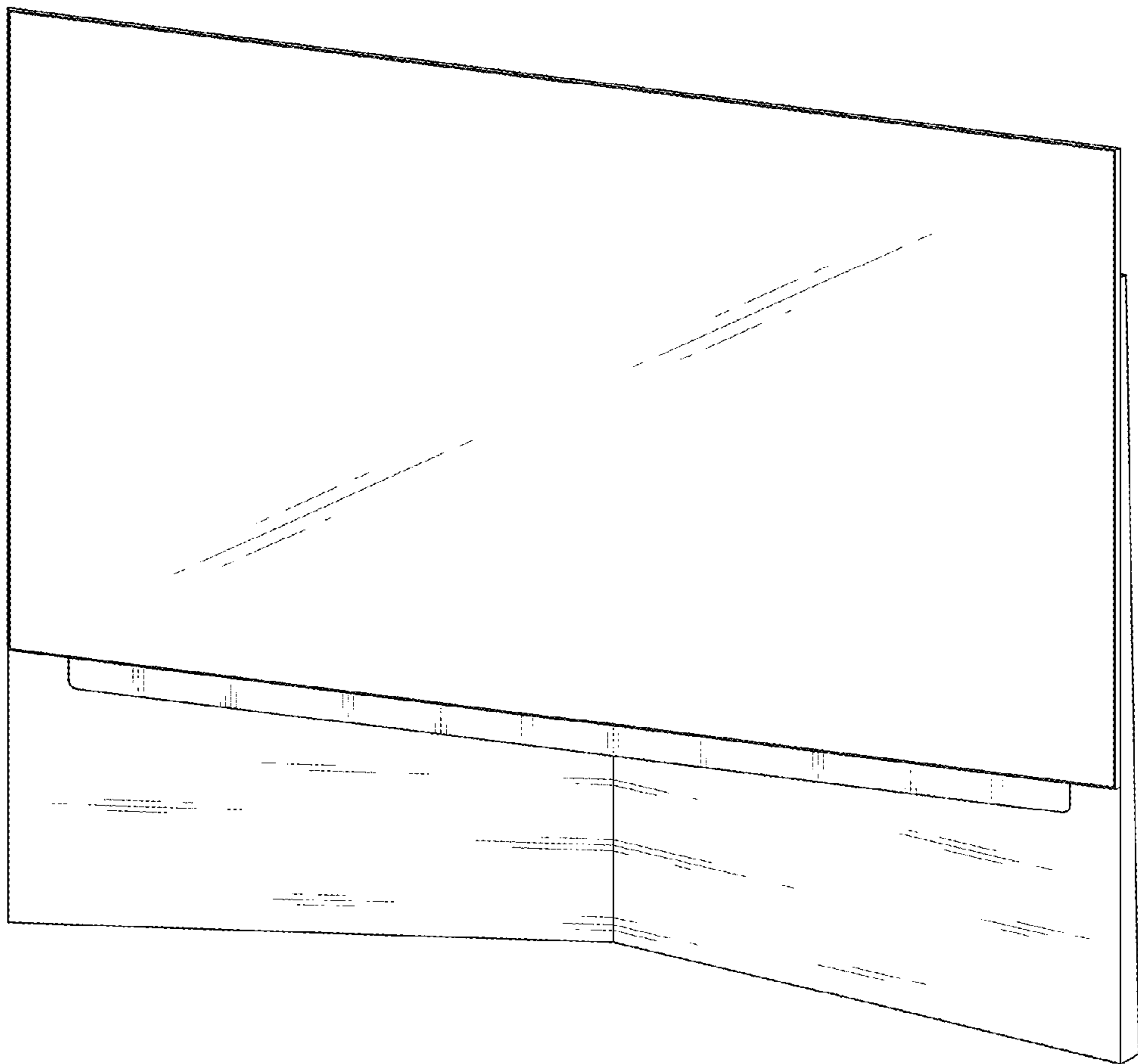

FIG. 17

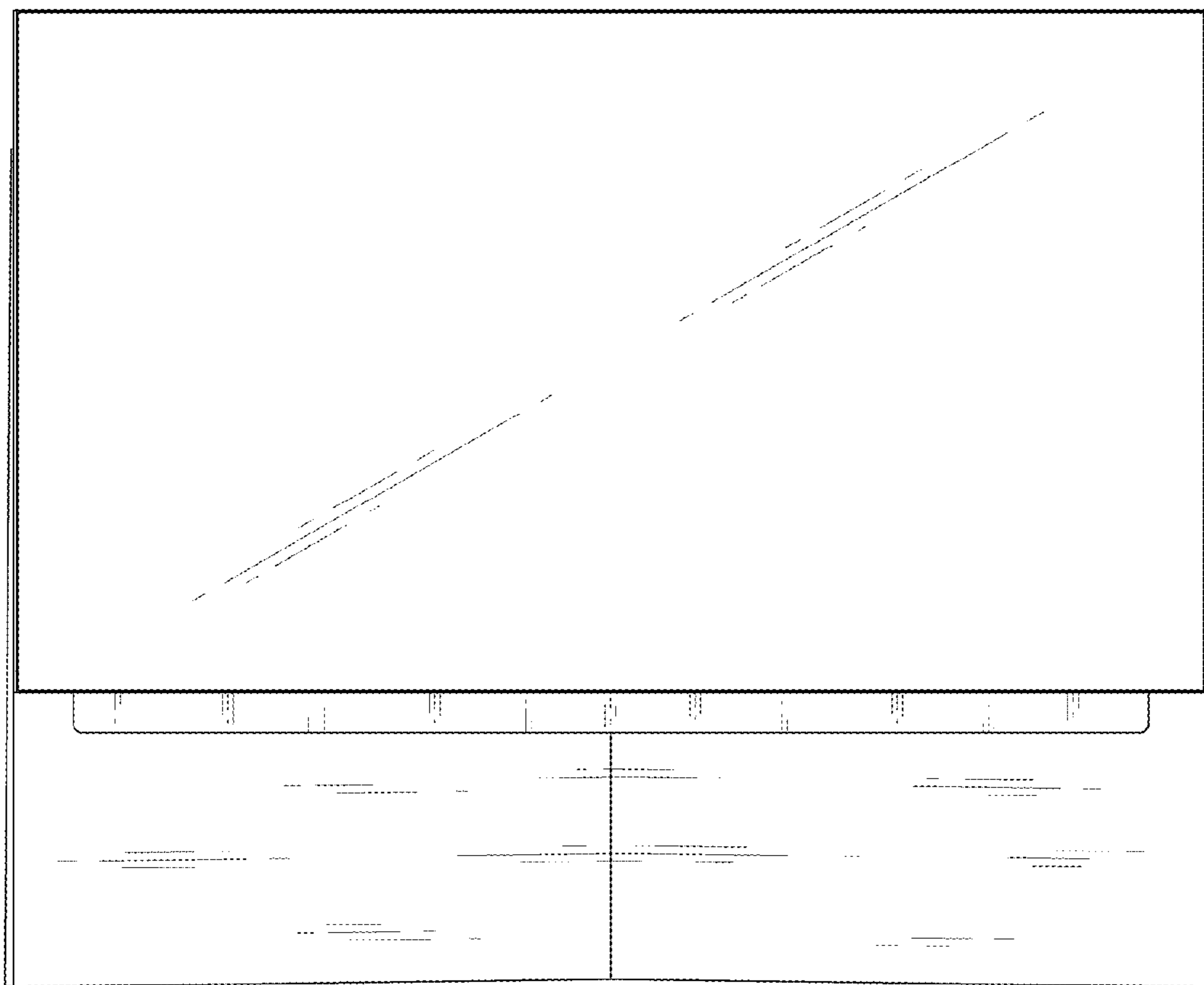

FIG. 18

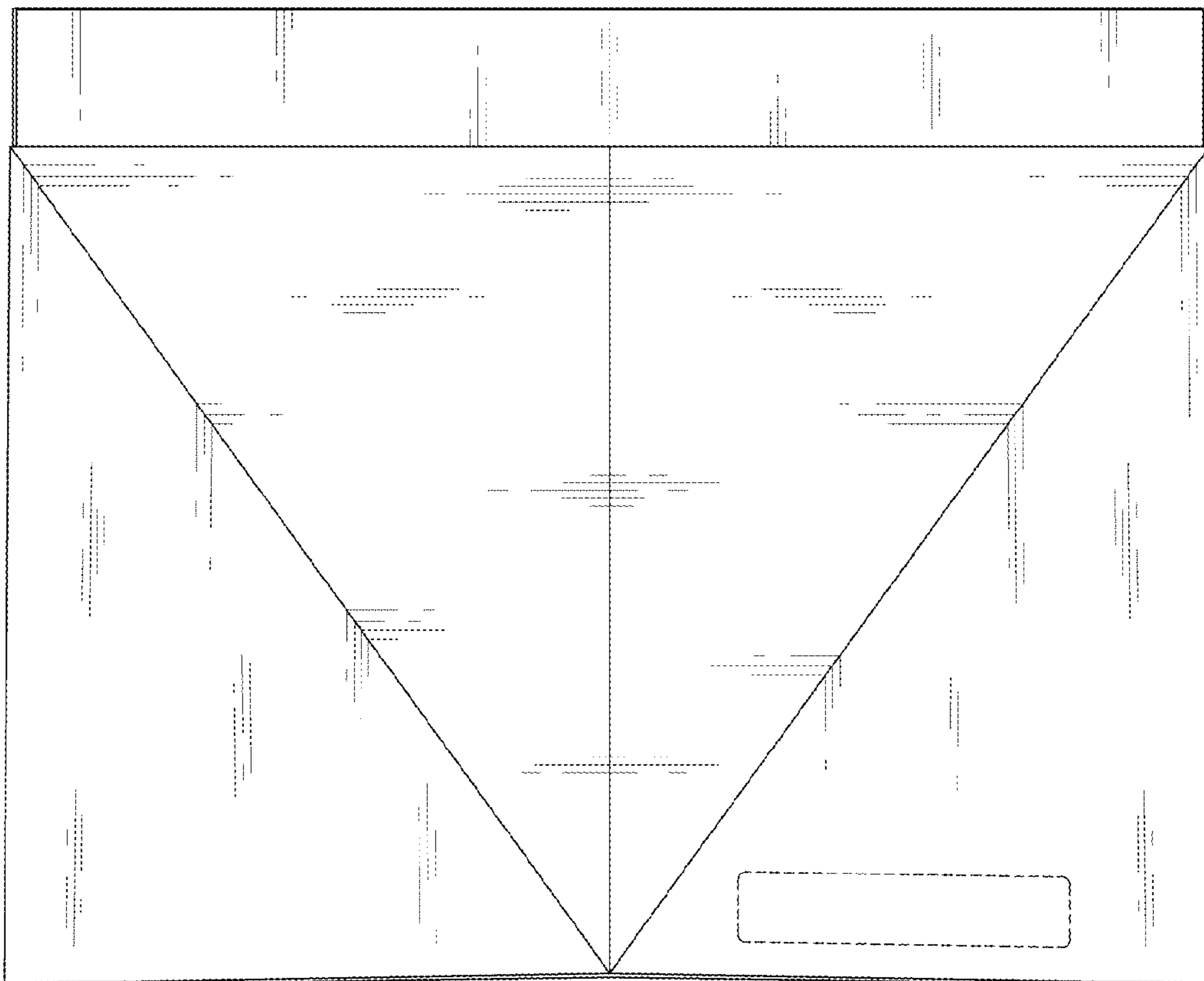

FIG. 19

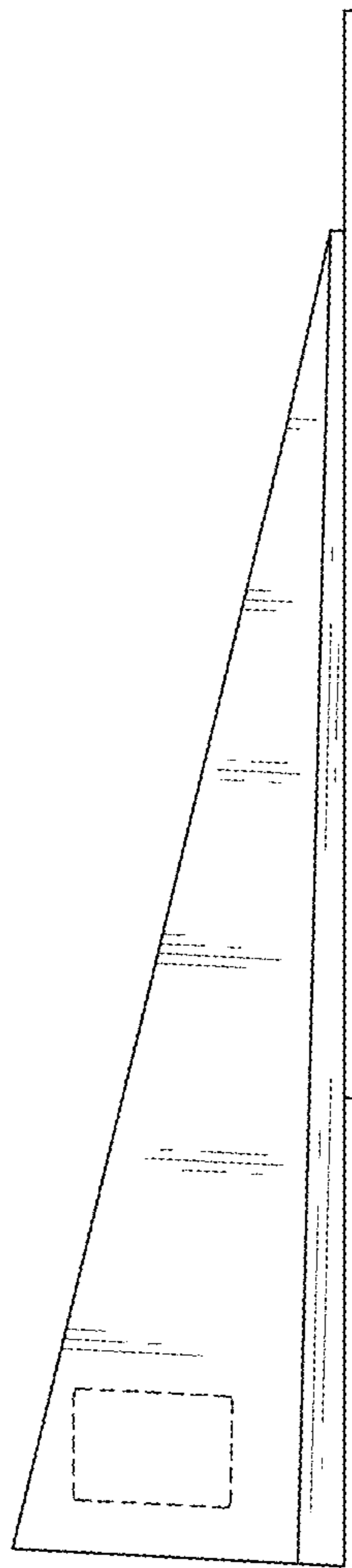

FIG. 20

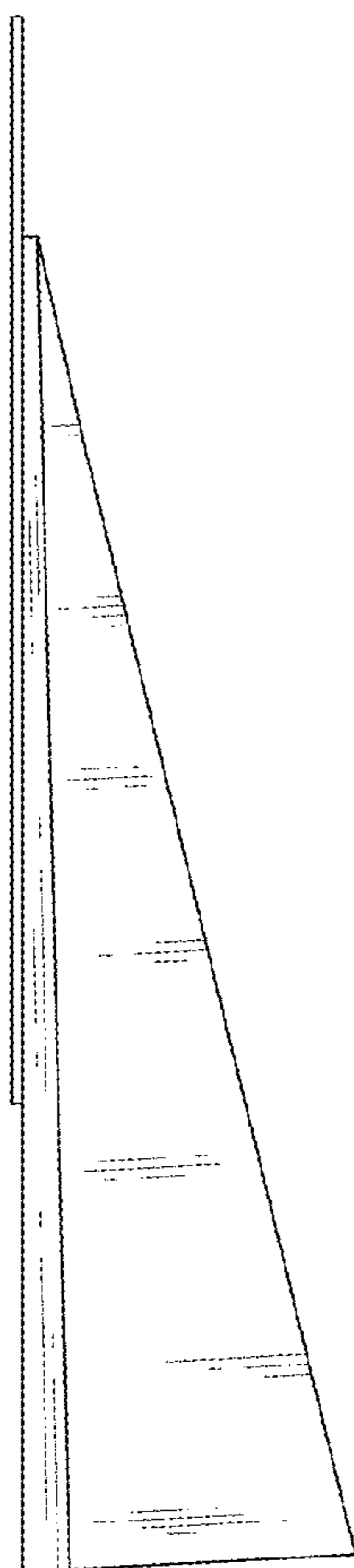

FIG. 21

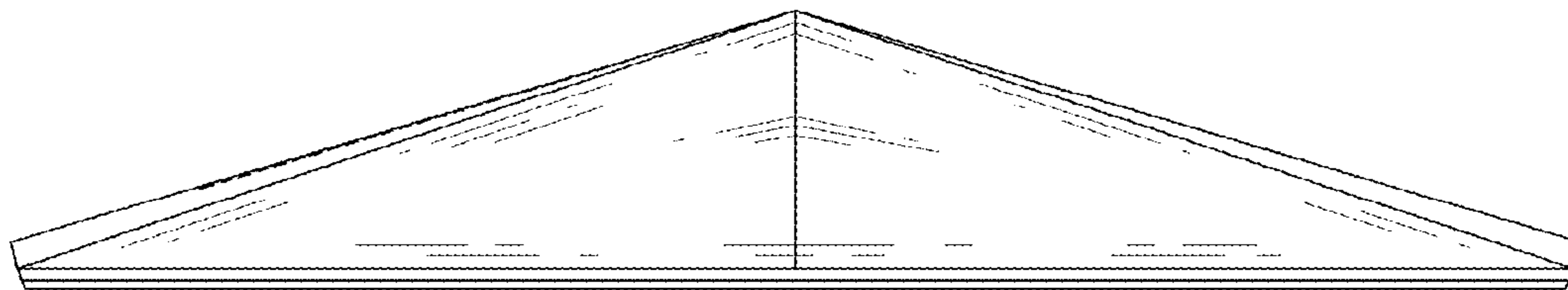

FIG. 22

