



US00D762143S

(12) **United States Design Patent**
Tu et al.

(10) **Patent No.:** **US D762,143 S**
(45) **Date of Patent:** **** Jul. 26, 2016**

- (54) **ELECTRIC VEHICLE**
- (71) Applicant: **Brue & Yin, LLC**, Rochelle, IL (US)
- (72) Inventors: **Chuan-sheng Tu**, Luoyang (CN); **Jie Ren**, Luoyang (CN); **Chengjun Wang**, Luoyang (CN)
- (73) Assignee: **Brue & Yin, LLC**, Rochelle, IL (US)
- (**) Term: **14 Years**
- (21) Appl. No.: **29/524,951**
- (22) Filed: **Apr. 24, 2015**
- (51) **LOC (10) Cl.** **12-08**
- (52) **U.S. Cl.**
USPC **D12/91; D12/86**
- (58) **Field of Classification Search**
USPC D12/86, 90-92, 88; D21/421, 433, 434;
296/181.1, 181.5
CPC B62D 35/00; B62D 25/00; B62D 25/06;
B62D 33/00
See application file for complete search history.

D684,091 S *	6/2013	Frenzel	D12/90
D696,606 S *	12/2013	Dong	D12/90
D719,062 S *	12/2014	Wada	D12/86
D724,999 S *	3/2015	Murray	D12/90

FOREIGN PATENT DOCUMENTS

CA	86164	3/1999
CA	134511	3/2011
DE	40201500221.0005	3/2015
DE	402105100399.0005	7/2015
EM	000009121-0001	4/2003
EM	000047212-0001	7/2003
EM	000111034-0001	11/2003
EM	000402151-0001	9/2005
EM	000537592-0002	5/2006

(Continued)

OTHER PUBLICATIONS

Allpar web page [online]; [retrieved on Feb. 12, 2016]; retrieved from the Internet: URL<www.allpar.com/reviews/Jeep/wrangler/.html>.

(Continued)

Primary Examiner — Melody N Brown
(74) *Attorney, Agent, or Firm* — Reed Smith, LLP

(57) **CLAIM**

The ornamental design for an electric vehicle, as shown and described.

DESCRIPTION

FIG. 1 is a perspective of an electric vehicle showing our new design;
FIG. 2 is a front view thereof;
FIG. 3 is a rear elevational view thereof;
FIG. 4 is a side elevational view thereof;
FIG. 5 is an opposite side elevational view thereof; and,
FIG. 6 is a top plan view thereof.

1 Claim, 4 Drawing Sheets

(56) **References Cited**

U.S. PATENT DOCUMENTS

D415,069 S	10/1999	Odette et al.	
D427,548 S	7/2000	Sacco et al.	
D535,585 S	1/2007	Moushegian et al.	
D567,144 S *	4/2008	Pocobello	D12/86
D588,958 S	3/2009	Zheng et al.	
D605,557 S *	12/2009	Murakami	D12/91
D605,558 S *	12/2009	Koman	D12/91
D610,039 S *	2/2010	Koide	D12/90
D622,183 S *	8/2010	Ishikura	D12/90
D651,132 S *	12/2011	Lambri	D12/86
D676,359 S *	2/2013	Panoz	D12/86
D678,819 S *	3/2013	Akamine	D12/90

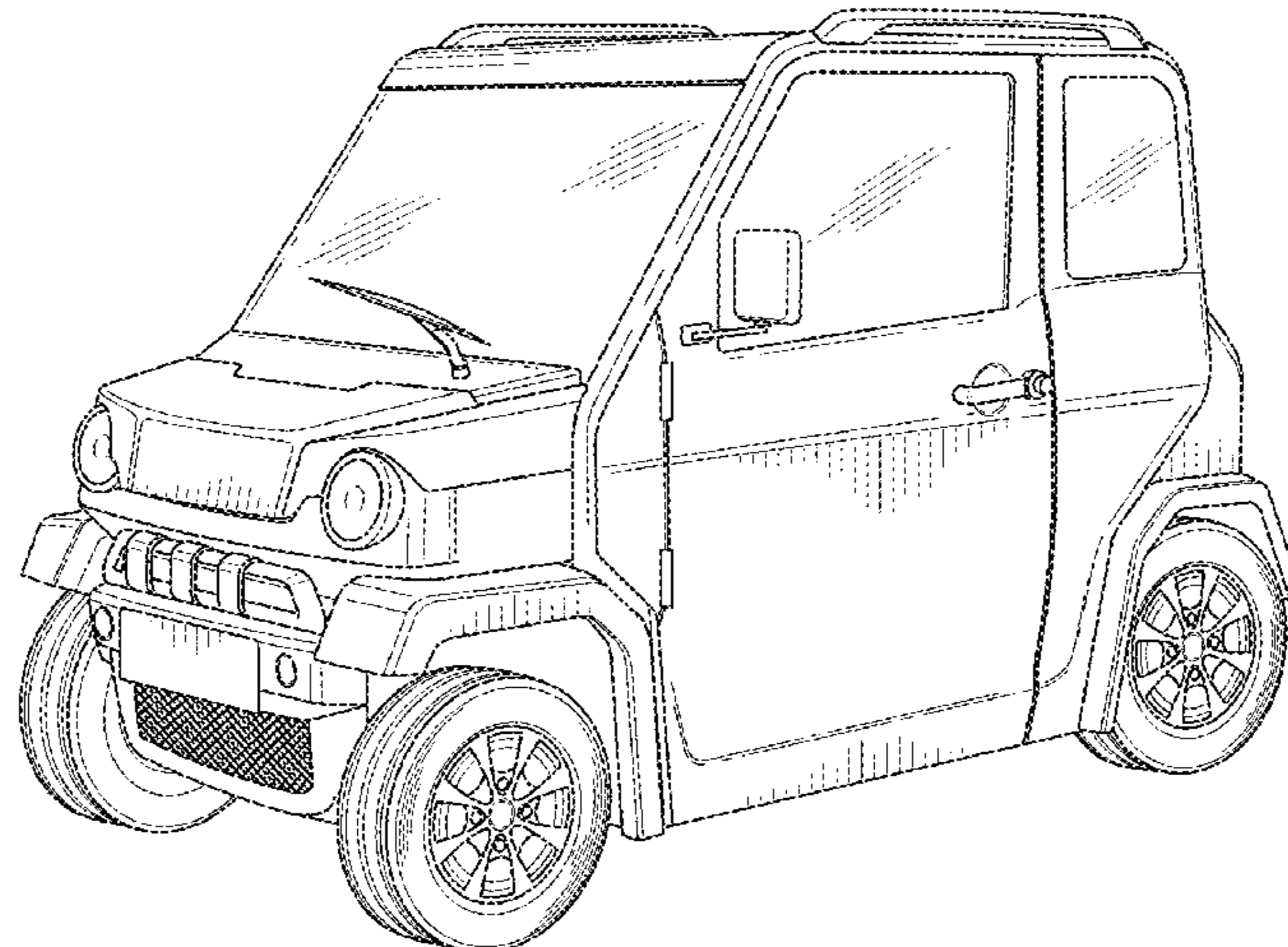

(56)

References Cited

FOREIGN PATENT DOCUMENTS

EM	000613468-0001	10/2006
EM	001427587-0001	12/2014
WO	DM047890	5/1999
WO	DM050573	1/2000
WO	DM074993	8/2010

OTHER PUBLICATIONS

Electriccarsreport web page [online]; [retrieved on Feb. 12, 2016] retrieved from the Internet: URL<electriccarsreport .com/2012/06/estark-electric-jeep-gets-electric-powertrain>.

Gizmag web page [online]; [retrieved on Feb. 12, 2016]; retrieved from the Internet: URL<www.gizmag.vom/prindiville-designs-electric-hummer/24168>.

* cited by examiner

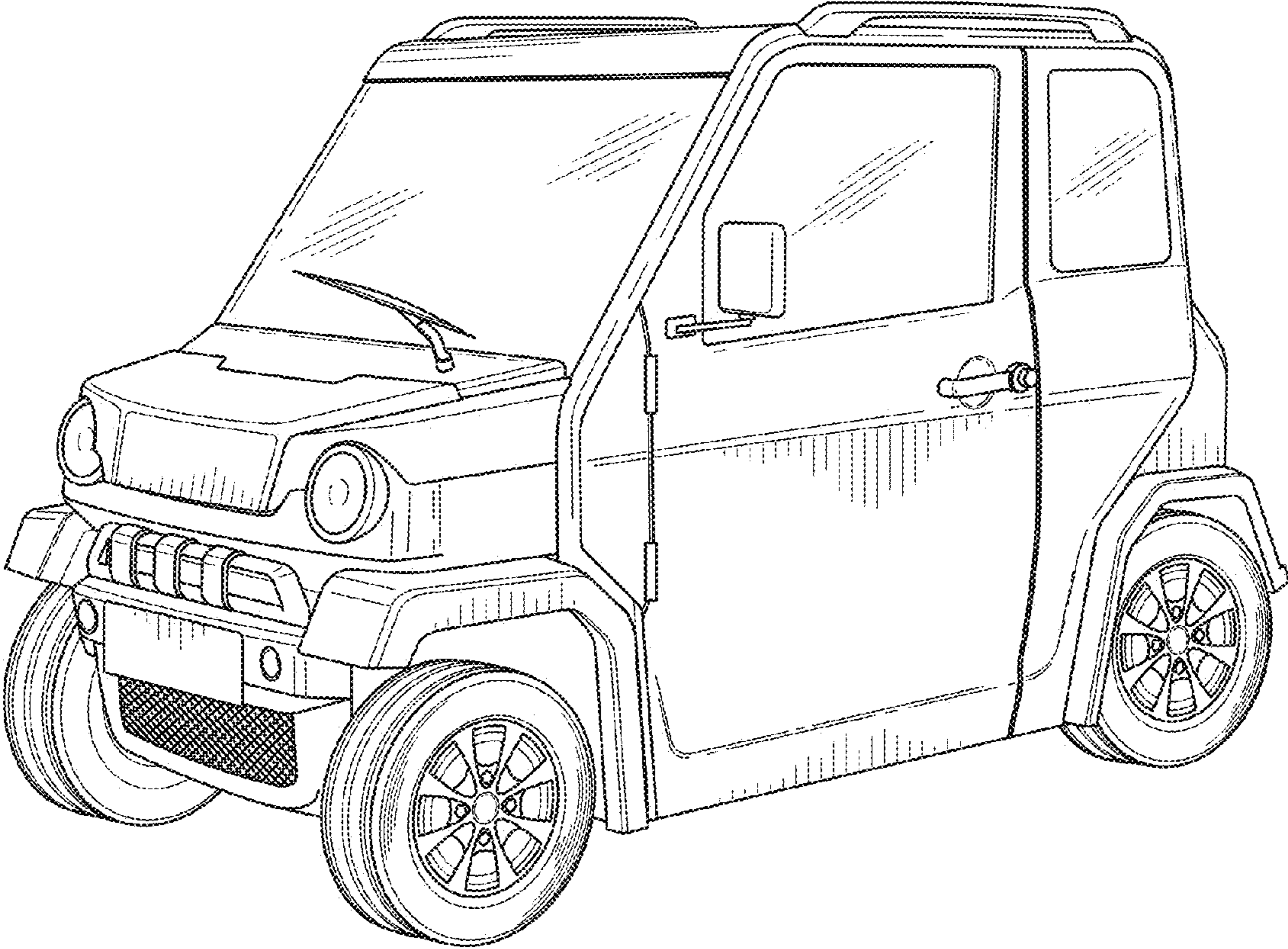

FIG. 1

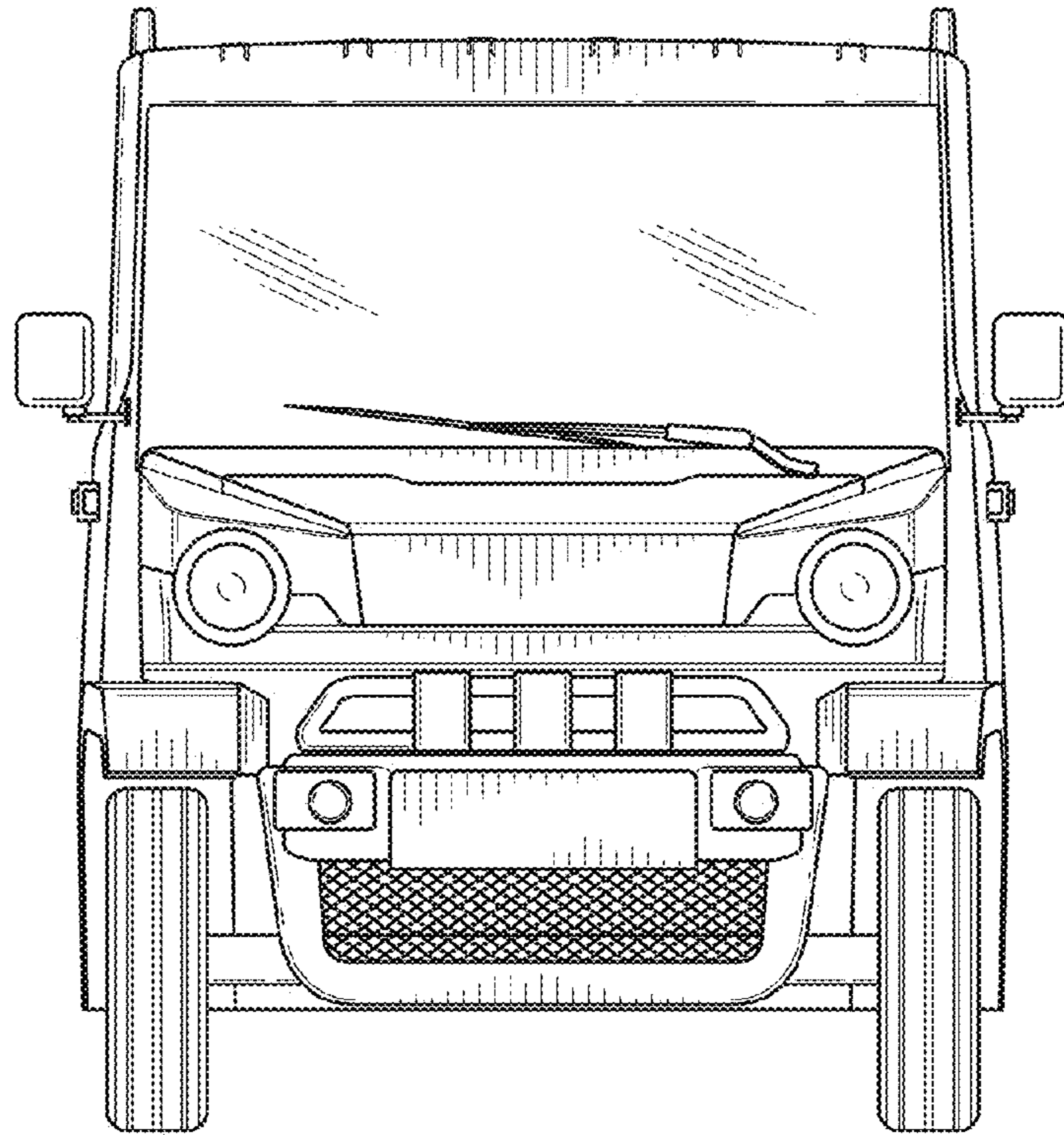

FIG. 2

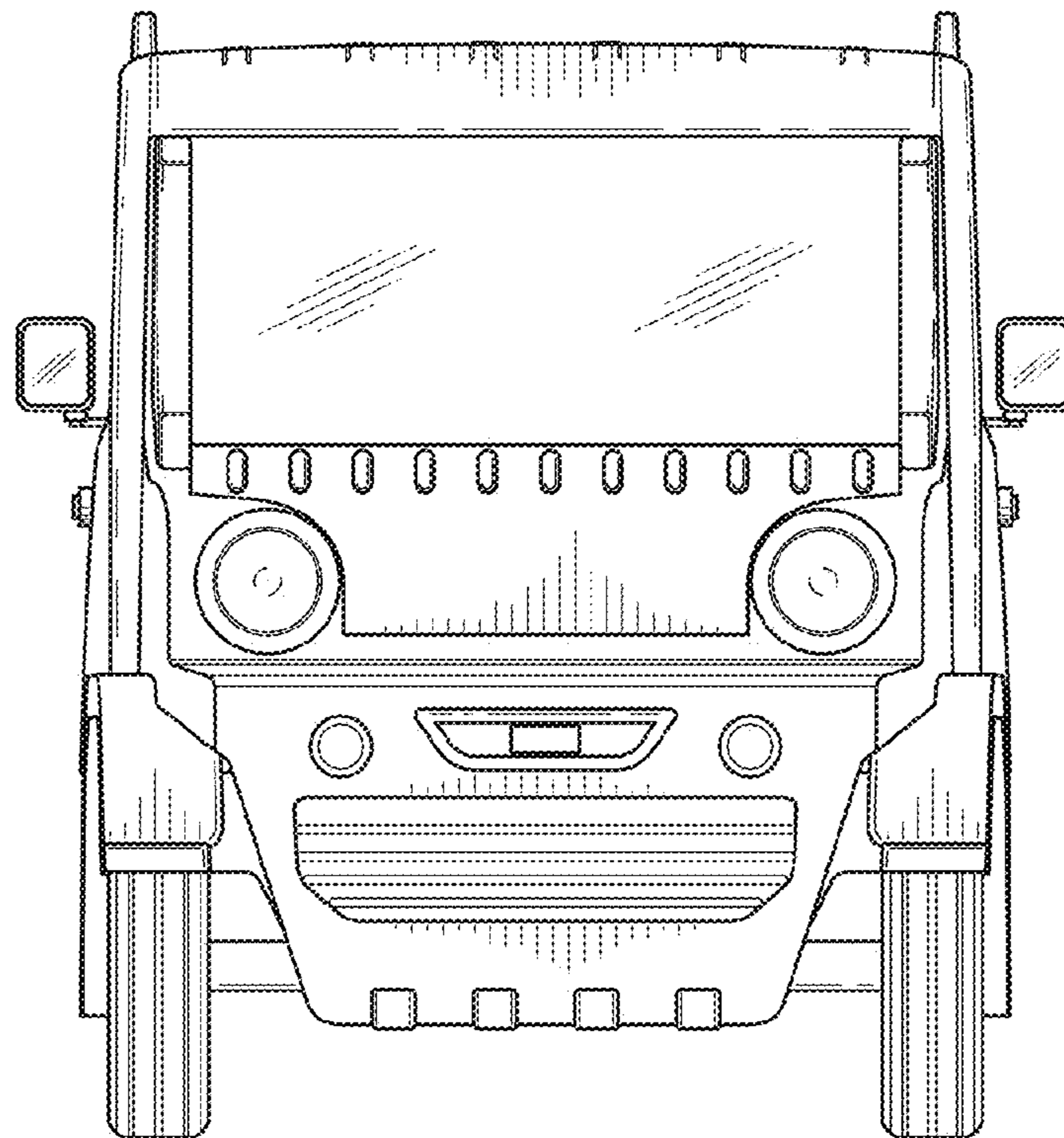

FIG. 3

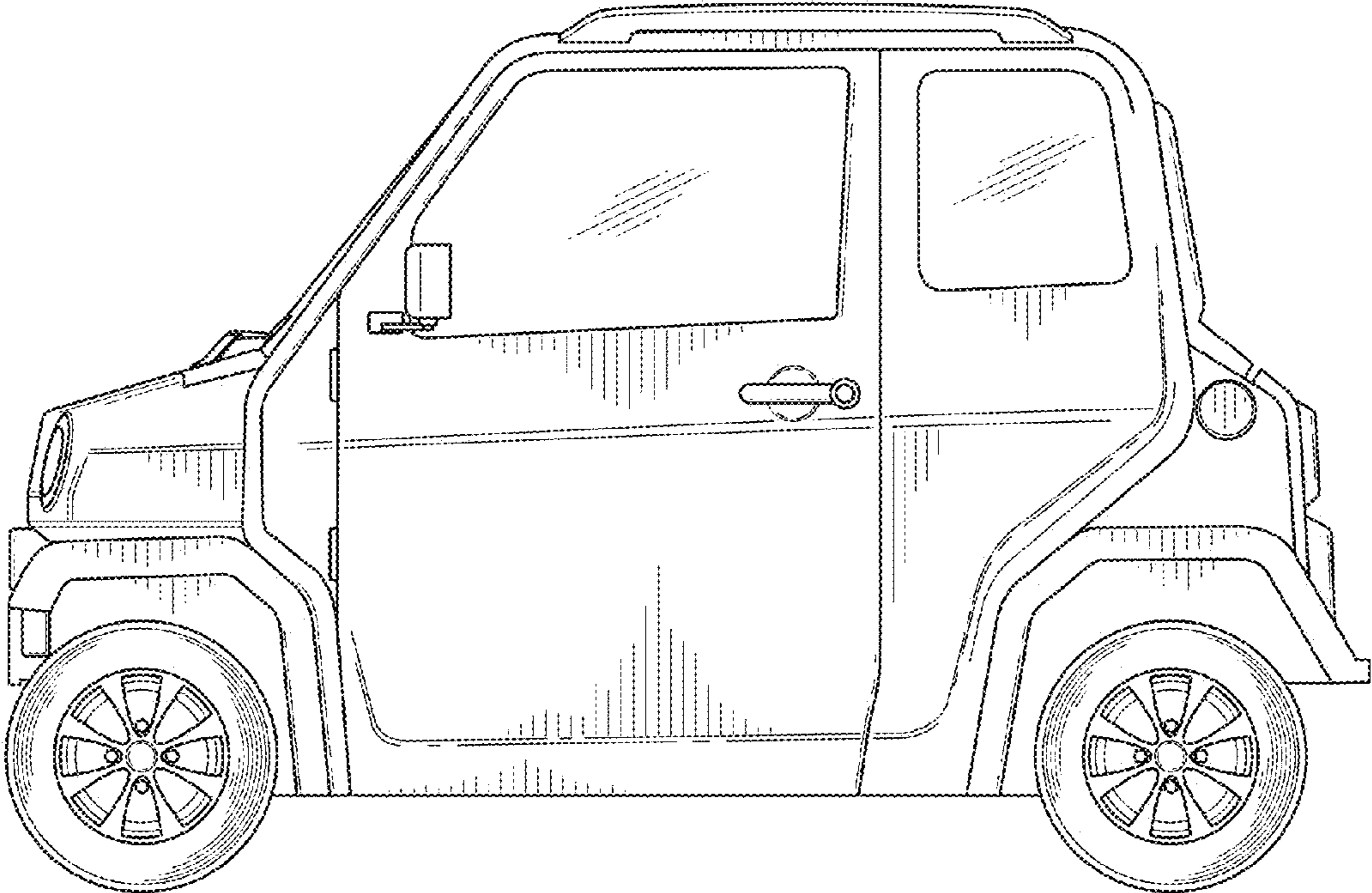

FIG. 4

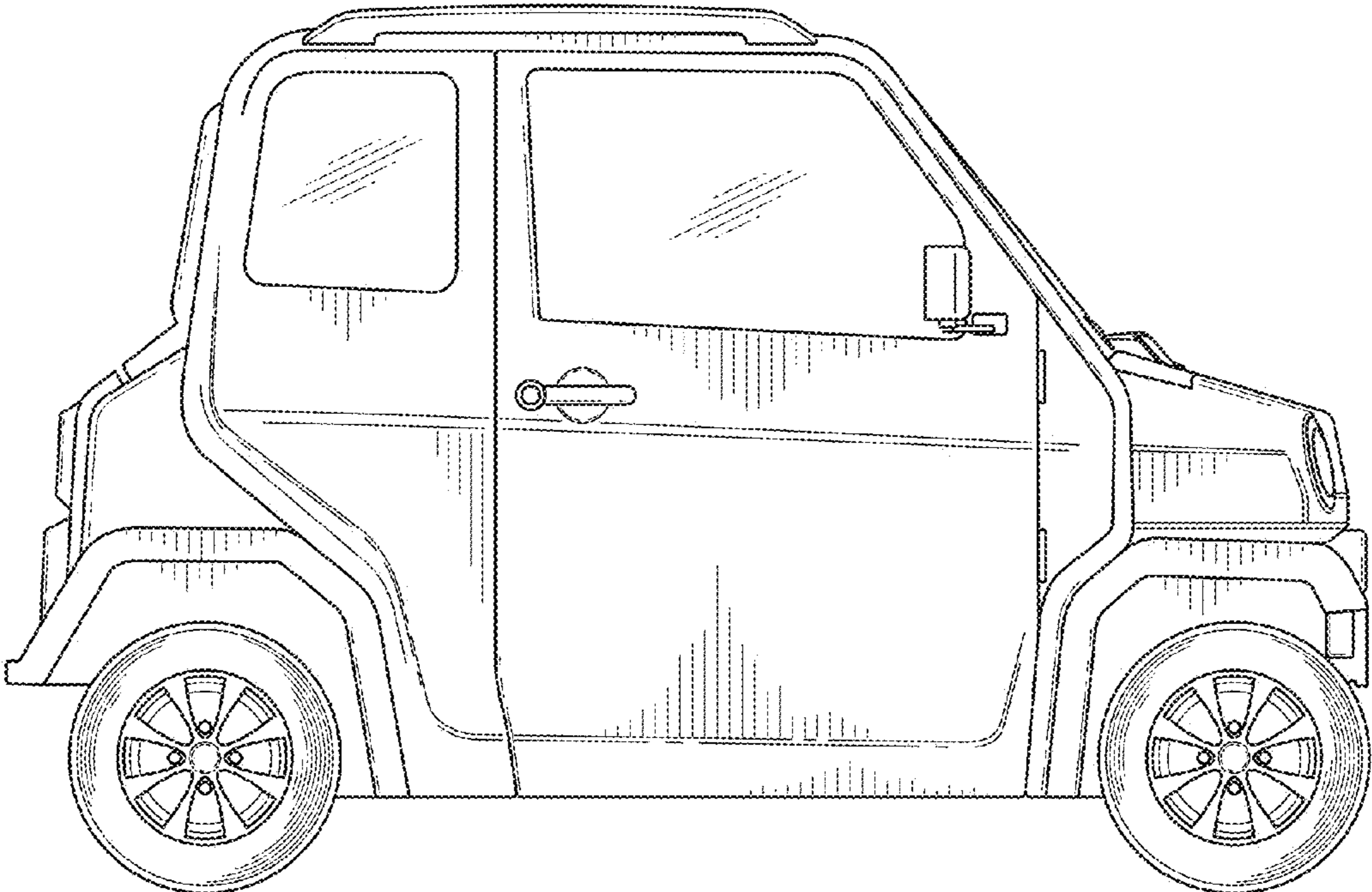

FIG. 5

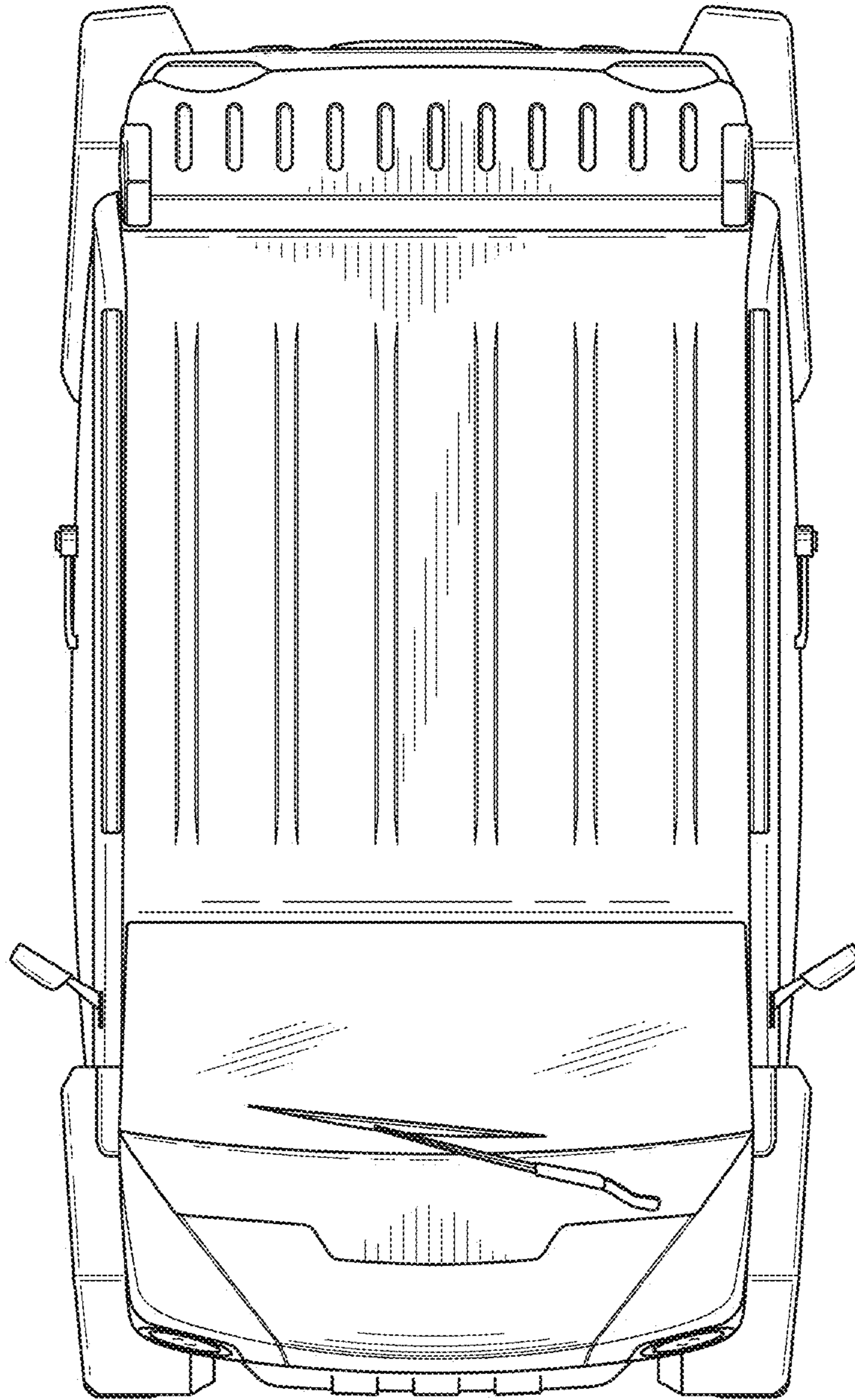

FIG. 6