



US00D762139S

(12) **United States Design Patent**
Wheelington

(10) **Patent No.:** **US D762,139 S**
(45) **Date of Patent:** **** Jul. 26, 2016**

- (54) **SUPPORT BAR FOR A TREE STAND**
- (71) Applicant: **Advanced Treestand Investments, LLC**, Smackover, AR (US)
- (72) Inventor: **Ryan S. Wheelington**, Louann, AR (US)
- (73) Assignee: **Advanced Treestand Investments, LLC**, Smackover, AR (US)
- (**) Term: **15 Years**
- (21) Appl. No.: **29/531,424**
- (22) Filed: **Jun. 25, 2015**
- (51) **LOC (10) Cl.** **06-99**
- (52) **U.S. Cl.**
USPC **D11/130**
- (58) **Field of Classification Search**
USPC D11/117, 121, 130, 130.1, 143, 144, D11/164
CPC A01G 17/00; A01G 17/04; A01G 17/08; A01G 17/10; A01G 17/12; A01G 17/14; A01G 17/16; A01G 9/12; A47G 33/12; A47G 33/1206; A47G 33/1213; A47G 33/1246; E04H 12/22; E04H 12/2238
See application file for complete search history.

5,443,342 A	8/1995	Huang	
5,507,362 A	4/1996	Krueger	
5,518,083 A *	5/1996	Blennert A01M 31/02 182/188
D373,427 S	9/1996	Russom	
5,641,036 A	6/1997	Maxwell	
5,848,666 A *	12/1998	Woodall A45F 3/26 182/187
5,853,066 A *	12/1998	Gohn A01M 31/02 182/116
RE36,276 E	8/1999	Smith	
5,947,666 A	9/1999	Huang	
5,988,963 A	11/1999	Shiau	
6,003,632 A	12/1999	Miller	
6,085,868 A	7/2000	Anthony et al.	
6,185,303 B1	2/2001	Losey	
D444,573 S	7/2001	Owens et al.	
D445,201 S	7/2001	D'Acquisto	
6,299,125 B1 *	10/2001	Zayeratabat A01G 29/00 248/121
6,322,279 B1	11/2001	Yamamoto et al.	
6,325,174 B1	12/2001	Lamar	
6,334,508 B1	1/2002	Shields	
6,367,585 B1	4/2002	Fast	
6,386,321 B1	5/2002	Muhich	

(Continued)

Primary Examiner — Elizabeth J Oswecki
(74) *Attorney, Agent, or Firm* — Brown & Michaels, PC

(56) **References Cited**

U.S. PATENT DOCUMENTS

535,887 A *	3/1895	Brown A47B 33/12 111/100
2,855,980 A	10/1958	Konieczka	
3,011,587 A *	12/1961	Mallog E04G 5/04 182/150
3,175,806 A	3/1965	Prete	
3,729,157 A *	4/1973	Haff A47G 33/045 248/519
4,120,379 A	10/1978	Carter	
4,236,602 A	12/1980	Leggett	
4,722,501 A	2/1988	Ruhl	
5,060,756 A	10/1991	D'Acquisto	
D332,439 S *	1/1993	Talley D12/406
5,282,520 A	2/1994	Walker	
5,375,808 A *	12/1994	Roy A47G 33/1213 248/523

(57) **CLAIM**

The ornamental design for a support bar for a tree stand, as shown and described.

DESCRIPTION

FIG. 1 is a front perspective view of a support bar for a tree stand showing my new design;
FIG. 2 is a side view thereof;
FIG. 3 is an opposite side view thereof;
FIG. 4 is a top view thereof;
FIG. 5 is a bottom view thereof;
FIG. 6 is a front view thereof;
FIG. 7 is a back view thereof; and,
FIG. 8 is a back perspective view thereof.

1 Claim, 8 Drawing Sheets

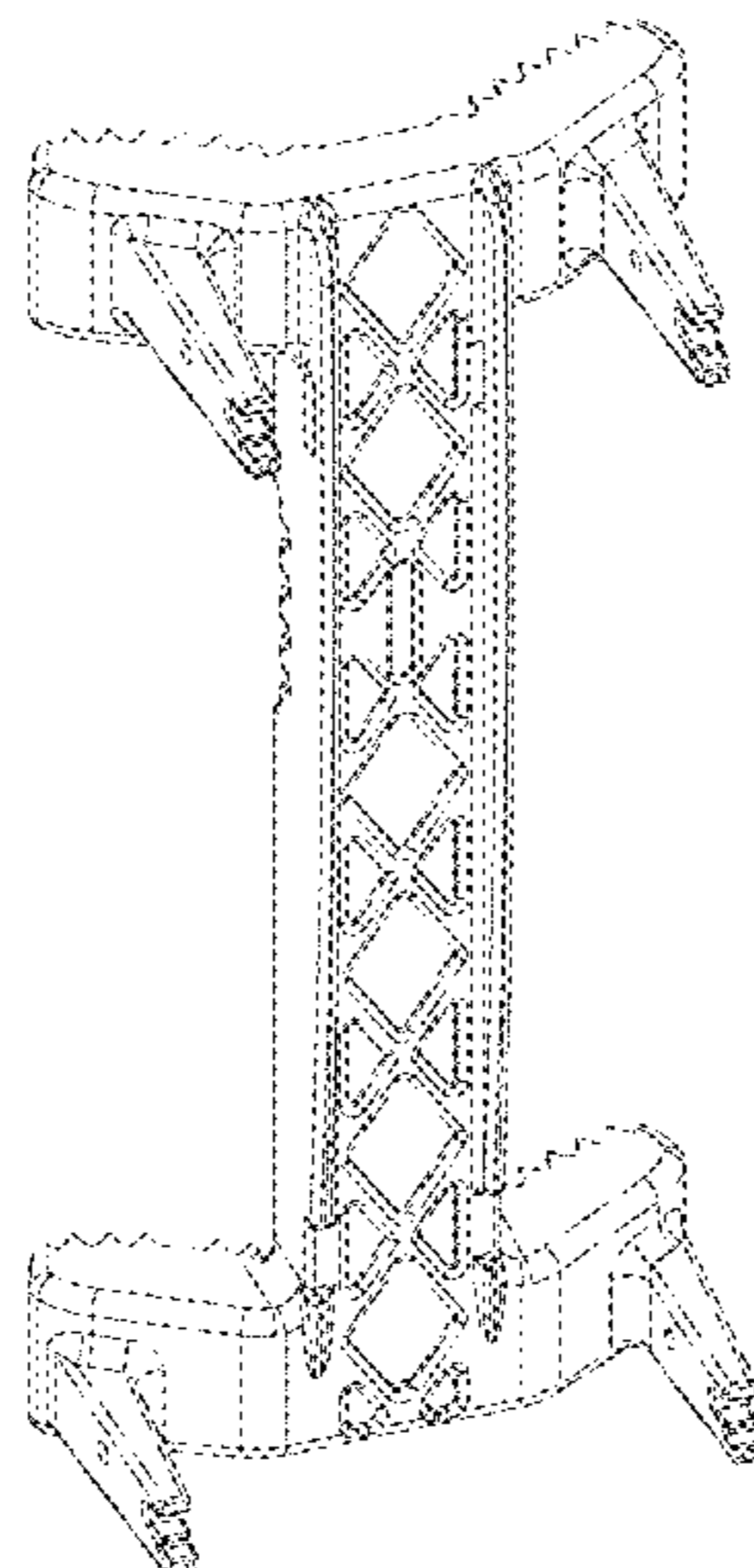

(56)

References Cited

U.S. PATENT DOCUMENTS

6,419,511 B2 *	7/2002	Lizell	A47B 21/06 248/121	8,657,071 B2 *	2/2014	Curry	A01M 31/02 182/128
D463,721 S *	10/2002	Boucher	D8/1	8,708,592 B1	4/2014	Gardner	
6,568,505 B1	5/2003	D'Acquisto		8,870,138 B2 *	10/2014	Maguire	B62J 11/00 24/269
6,571,916 B1	6/2003	Swanson		D721,186 S	1/2015	Wheelington	
6,702,239 B2	3/2004	Boucher		D725,292 S	3/2015	Wheelington	
6,722,472 B2	4/2004	Berkbuegler		9,027,709 B2	5/2015	Wheelington	
6,837,642 B1	1/2005	Lin		2002/0148685 A1	10/2002	Shan et al.	
6,880,810 B1	4/2005	Hu		2003/0192741 A1	10/2003	Berkbuegler	
6,964,126 B1 *	11/2005	Anderson	A01G 17/04 248/511	2004/0149871 A1	8/2004	Authement	
7,036,632 B1 *	5/2006	Price	A01M 31/025 182/187	2006/0054397 A1	3/2006	Pringnitz	
7,156,206 B2 *	1/2007	Prejean	A01M 31/02 182/136	2007/0151803 A1	7/2007	D'Acquisto	
7,296,658 B1	11/2007	Pederson		2007/0235261 A1	10/2007	Forrest	
D564,937 S *	3/2008	Pestru	D11/130	2007/0261919 A1	11/2007	Roe	
7,377,361 B1	5/2008	Tschida		2009/0064743 A1	3/2009	Gee	
7,845,621 B1	12/2010	Lu		2009/0095569 A1	4/2009	Cooper et al.	
7,926,775 B1 *	4/2011	Milazzo	A01M 31/02 248/230.8	2009/0321186 A1	12/2009	Louchart	
8,177,177 B2	5/2012	Ehrig et al.		2010/0176263 A1	7/2010	Ehrig et al.	
8,434,979 B1	5/2013	Genge		2010/0300808 A1	12/2010	Hale	
8,490,930 B2	7/2013	Huang		2011/0041300 A1	2/2011	Lu	
8,534,423 B1 *	9/2013	Brabham	A01M 31/02 182/187	2011/0132686 A1	6/2011	Priest	
				2011/0308887 A1	12/2011	Johnson	
				2012/0119044 A1	5/2012	Wilson	
				2012/0199418 A1	8/2012	Priest	
				2014/0131137 A1 *	5/2014	Bassett	A01M 31/02 182/116
				2014/0311828 A1 *	10/2014	Bassett	A01M 31/02 182/124

* cited by examiner

Fig. 1

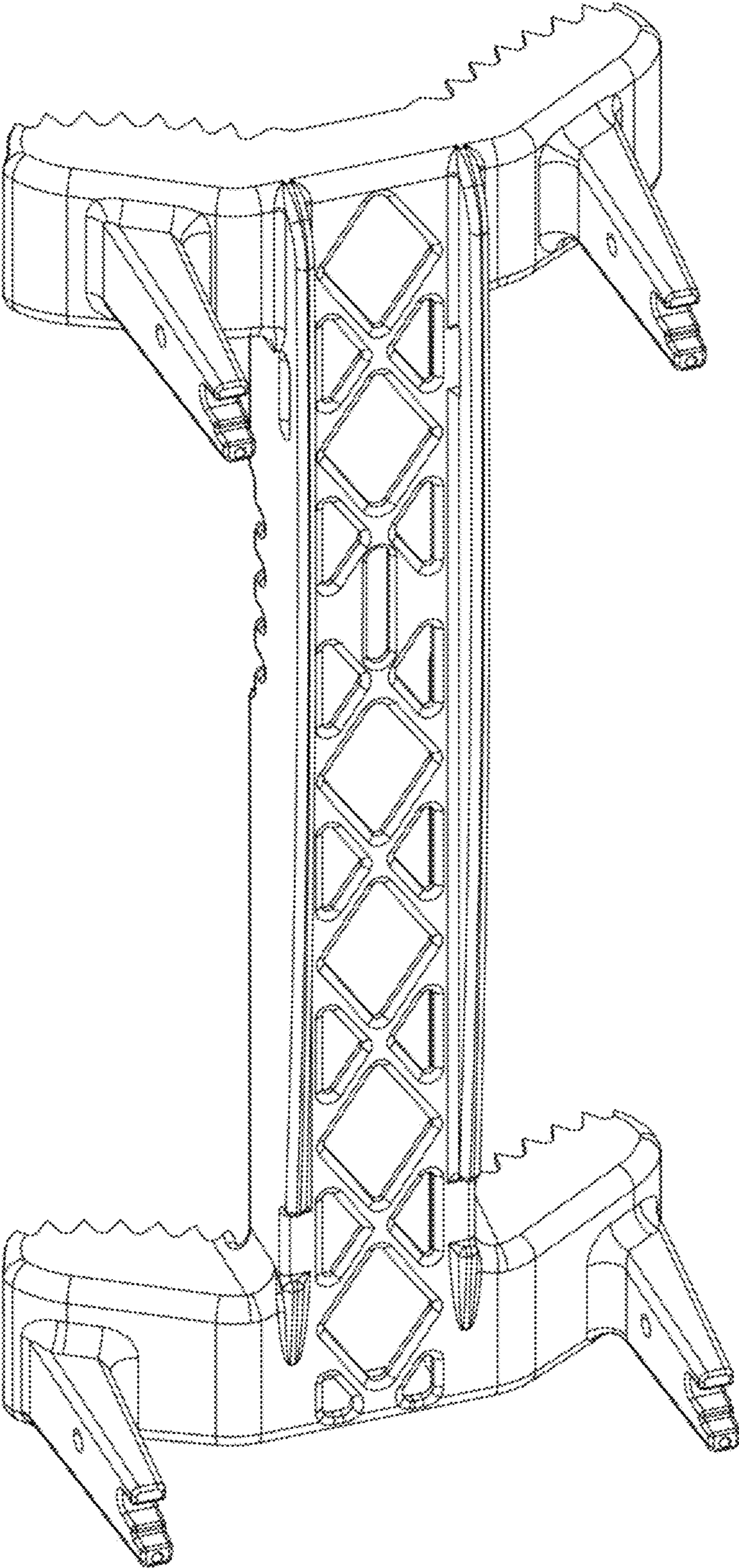

Fig. 2

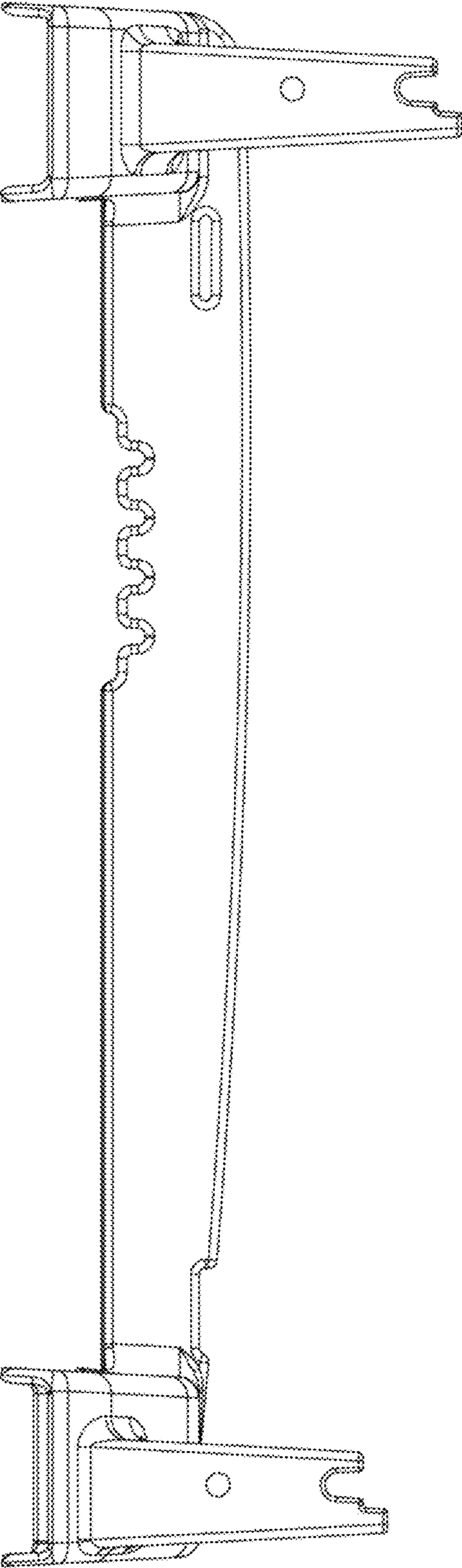

Fig. 3

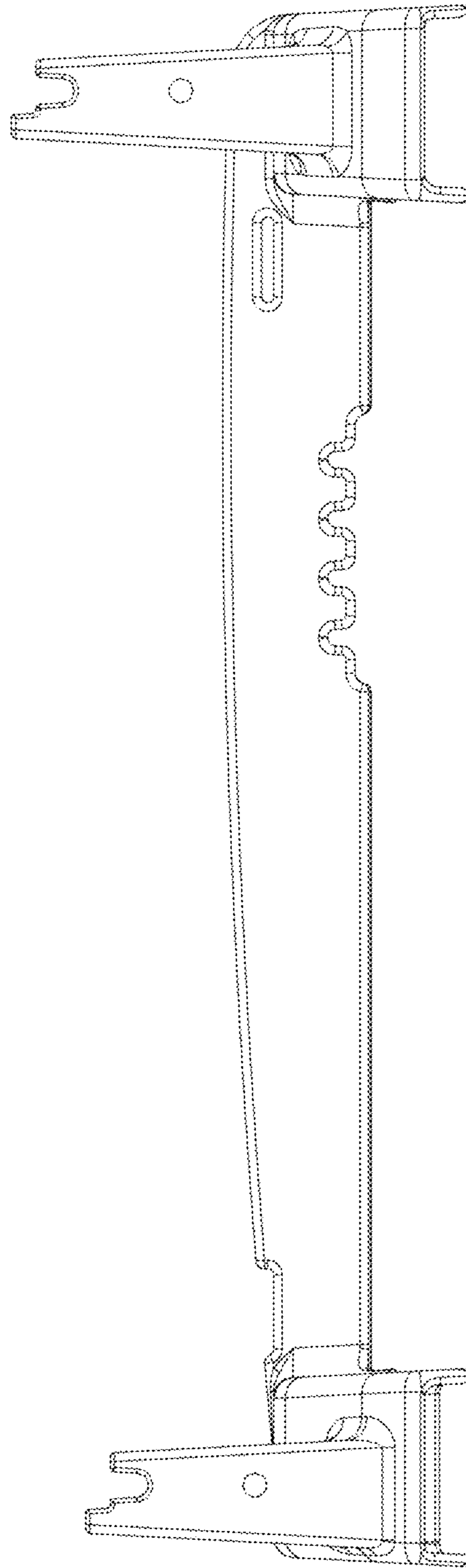

Fig. 4

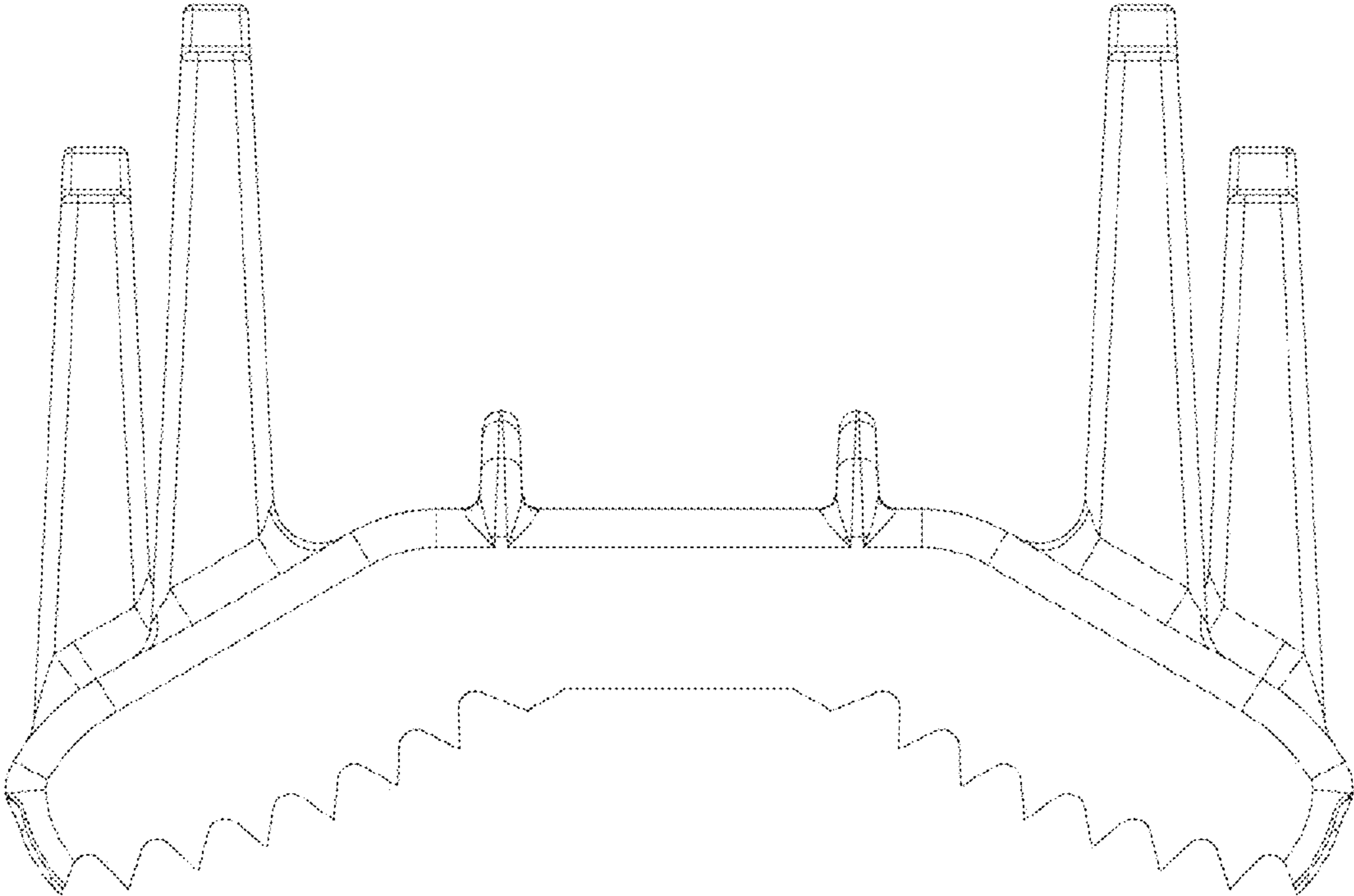

Fig. 5

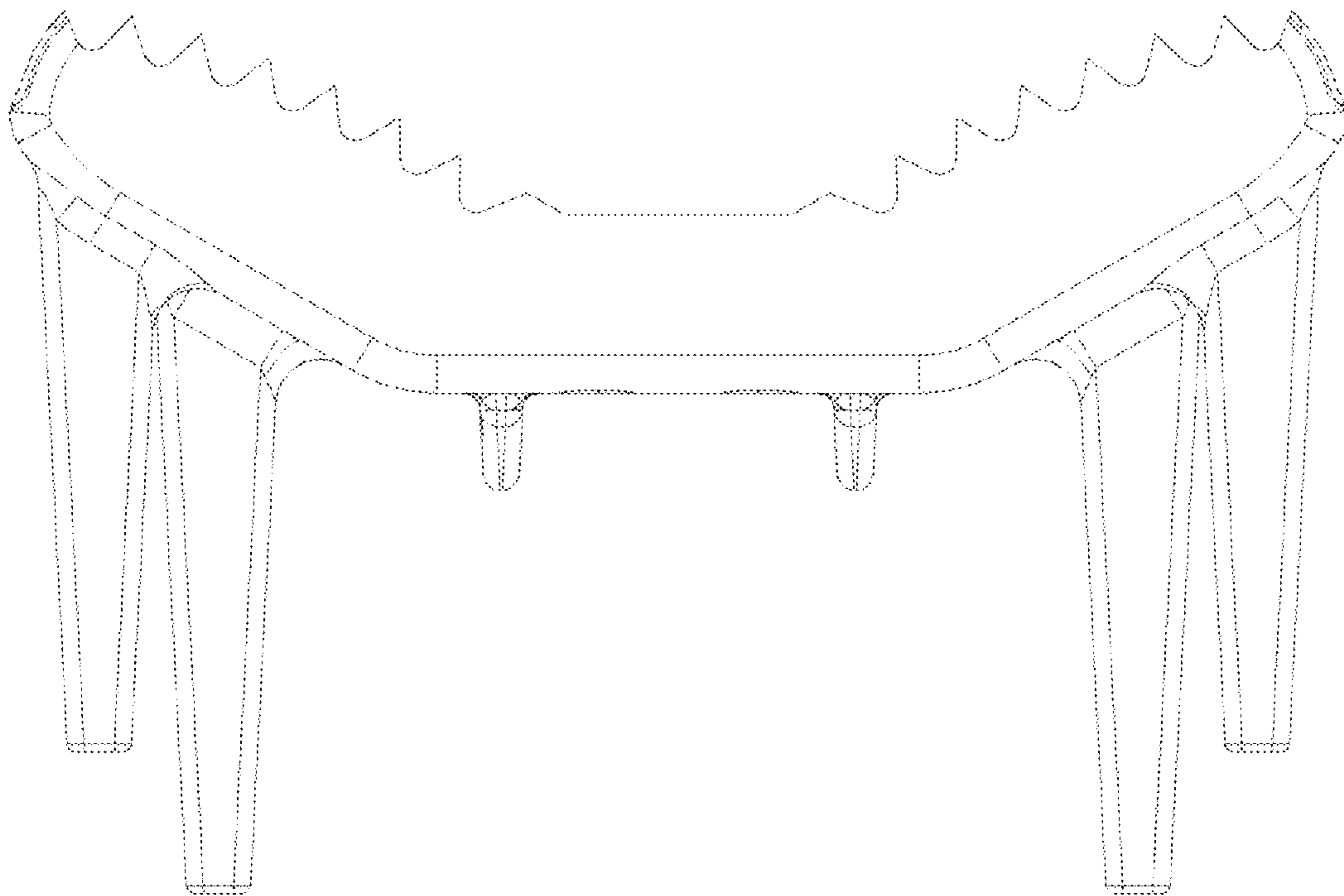

Fig. 6

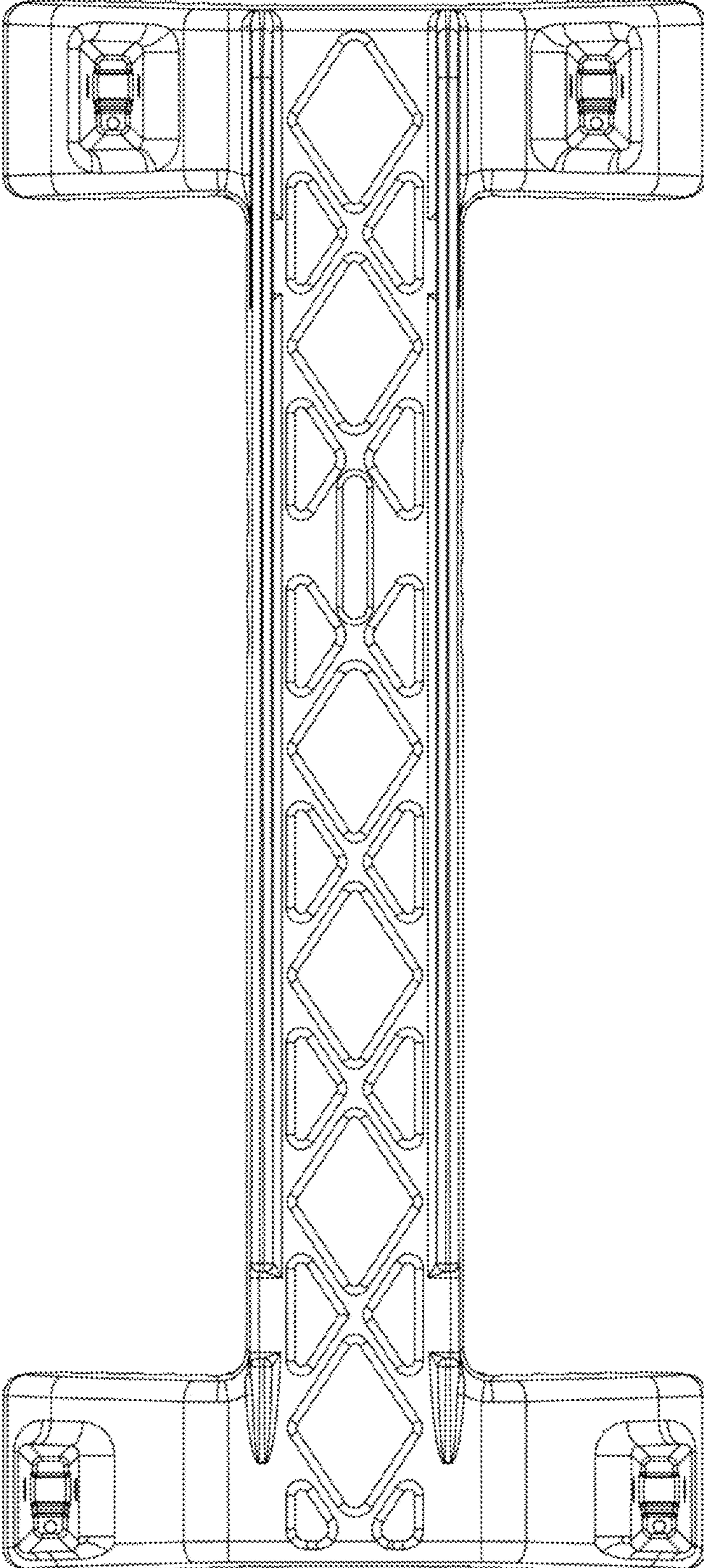

Fig. 7

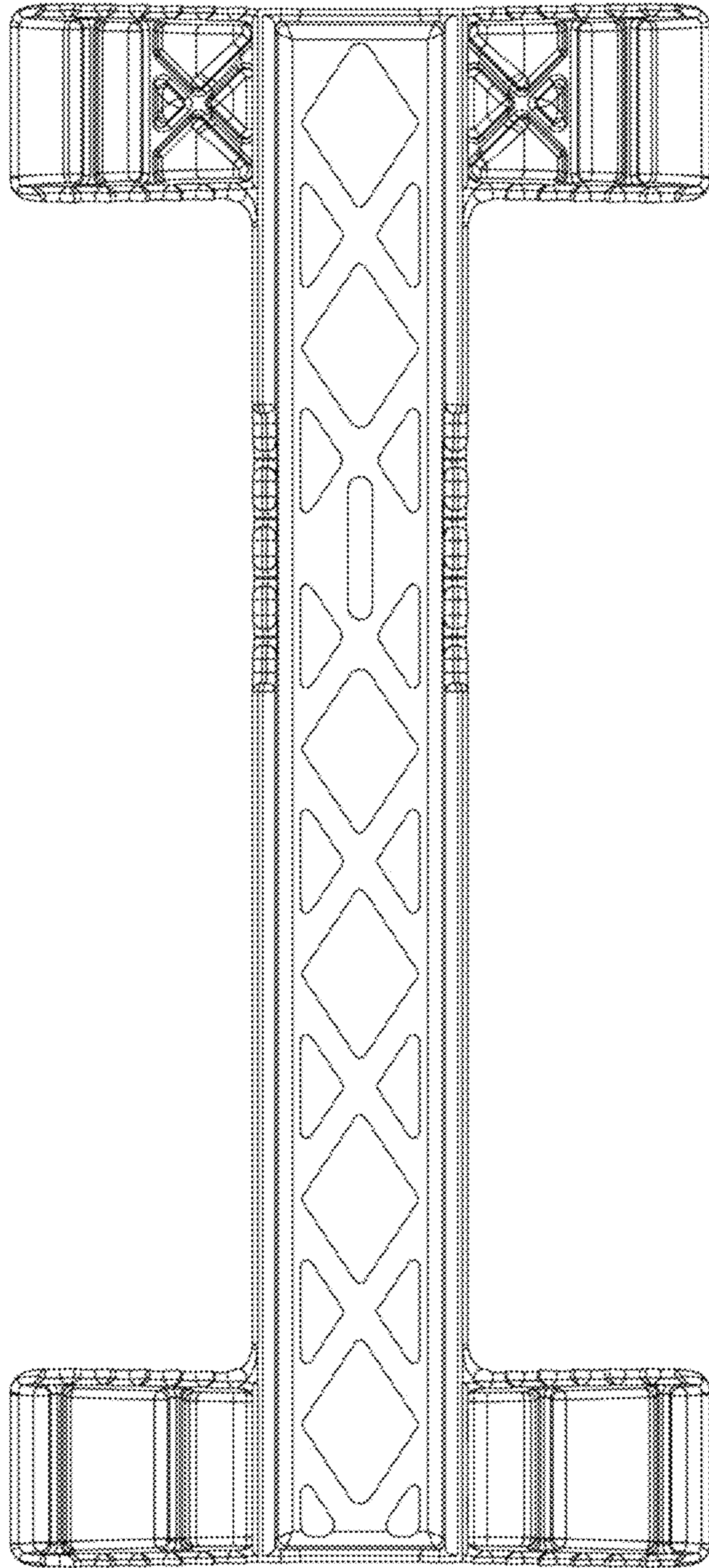

Fig. 8

