

US00D762136S

(12) **United States Design Patent**
Weinshanker

(10) **Patent No.:** **US D762,136 S**
(45) **Date of Patent:** **** Jul. 26, 2016**

(54) **CABLE ACCESSORY**

(71) Applicant: **National Entertainment Collectibles Association, Inc.**, Hillside, NJ (US)

(72) Inventor: **Joel Weinshanker**, Las Vegas, NV (US)

(73) Assignee: **National Entertainment Collectibles Association, Inc.**, Hillside, NJ (US)

(**) Term: **14 Years**

(21) Appl. No.: **29/509,698**

(22) Filed: **Nov. 20, 2014**

Related U.S. Application Data

(62) Division of application No. 29/467,983, filed on Sep. 25, 2013, now Pat. No. Des. 724,477.

(51) **LOC (10) Cl.** **11-01**

(52) **U.S. Cl.**
USPC **D11/83**; D14/232; D21/621

(58) **Field of Classification Search**
USPC D11/1, 83, 150, 160, 161, 136, 128,
D11/182; D14/205, 223, 299, 220, 232,
D14/190; D21/621, 622, 623, 630, 631,
D21/632, 633, 634, 635, 636, 637;
D12/200, 194; D13/154, 199; D3/211;
D2/978; D7/396.2

CPC A44C 25/00; A44C 25/001; A44C 25/002;
A44C 25/004; A44C 25/005; A44C 25/007;
A44C 25/008; A63H 3/00; G09F 19/08;
G09F 19/086; B60R 13/00; B60R 13/005

See application file for complete search history.

(56) **References Cited**

U.S. PATENT DOCUMENTS

D196,639 S * 10/1963 Irving D21/637

(Continued)

OTHER PUBLICATIONS

[Online] <http://www.entertainmentearth.com/images/AUTOIMAGES/NC14500AAlg.jpg>. Retrieved Nov. 13, 2015.*

(Continued)

Primary Examiner — Garth Rademaker

Assistant Examiner — Melanie Pellegrini

(74) *Attorney, Agent, or Firm* — McCarter & English, LLP

(57) **CLAIM**

The ornamental design for a cable accessory, as shown and described.

DESCRIPTION

FIG. 1 is a perspective view of a cable accessory as shown and described;

FIG. 2 is a front view of the cable accessory of FIG. 1;

FIG. 3 is a back view of the cable accessory of FIG. 1;

FIG. 4 is a right view of the cable accessory of FIG. 1;

FIG. 5 is a left view of the cable accessory of FIG. 1;

FIG. 6 is a top view of the cable accessory of FIG. 1; and,

FIG. 7 is a bottom view of the cable accessory of FIG. 1.

The broken lines shown in the drawings showing a cable and ear buds represent environmental matter and all other broken lines illustrate portions of the cable accessory that form no part of the claimed design.

1 Claim, 5 Drawing Sheets

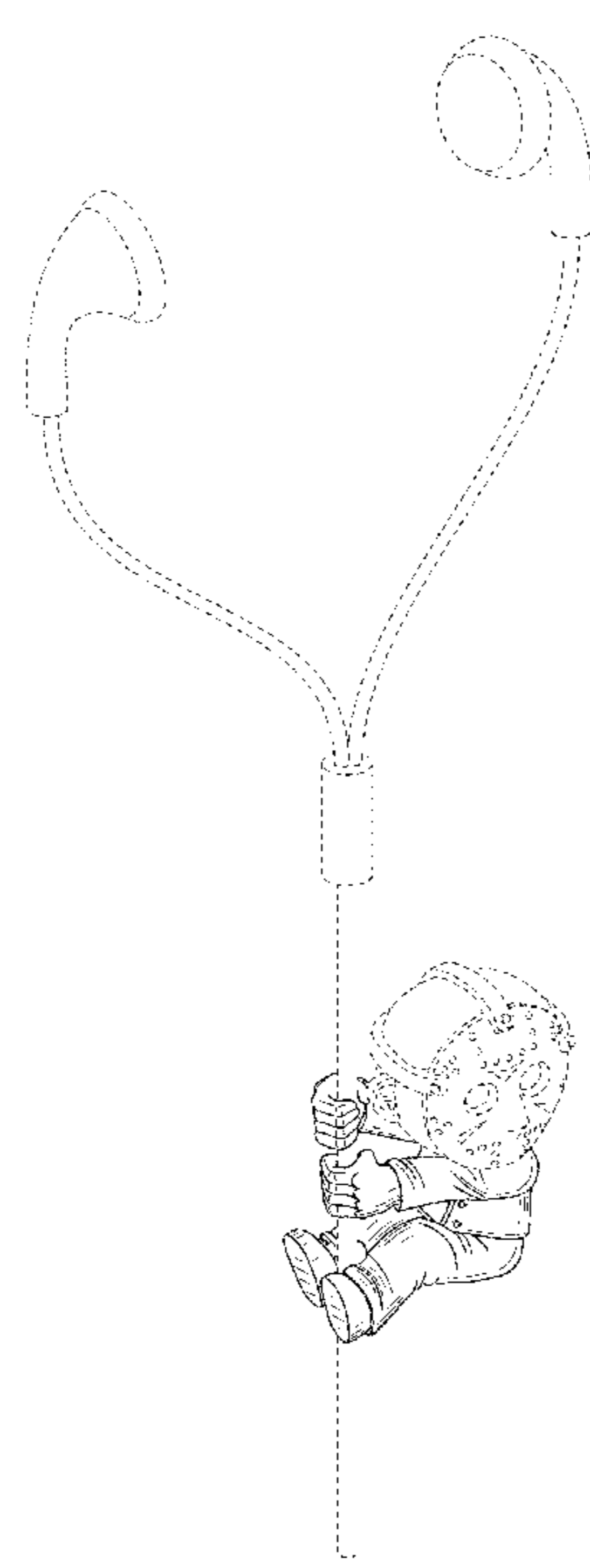

(56)

References Cited

U.S. PATENT DOCUMENTS

4,824,414	A *	4/1989	Goldblatt	A63H 3/06 446/226
D308,283	S	6/1990	Bergman et al.	
5,600,098	A	2/1997	Kazaks	
D383,666	S	9/1997	Adams	
D398,775	S *	9/1998	Fritsche	D11/83
D420,064	S *	2/2000	Poirier	D21/578
D425,069	S *	5/2000	Suh	D11/129
D437,123	S *	2/2001	Leon	D6/300
D437,368	S	2/2001	Tsai	
D438,489	S *	3/2001	Young	D11/160
D439,778	S	4/2001	Gumbs	
D469,248	S *	1/2003	Fritsche	D3/211
D474,515	S	5/2003	Reiher et al.	
D486,864	S *	2/2004	Bresciani	D11/160
D496,076	S *	9/2004	Klaus	D21/594
D531,542	S *	11/2006	McGowen	D11/160
D536,010	S *	1/2007	Takahashi	D15/199
D556,840	S *	12/2007	Wilk	D21/621
D559,670	S	1/2008	Levesque et al.	
D577,542	S *	9/2008	Bloom	D7/393
D594,870	S *	6/2009	Leung	D14/480.2
D596,013	S *	7/2009	Simmons	D8/356
D596,014	S	7/2009	Wen	
D599,644	S	9/2009	Wen et al.	
D608,679	S	1/2010	Jouan	
D623,176	S *	9/2010	Canchola	D14/232
D638,074	S *	5/2011	Wong	D21/621
D640,326	S *	6/2011	Wu	D19/99
D675,866	S *	2/2013	Wisniewski	D7/213
D677,148	S *	3/2013	Hammer	D8/402
D689,136	S *	9/2013	Crutchley	D19/86
D724,477	S *	3/2015	Weinshanker	D11/83

OTHER PUBLICATIONS

[Online] <http://pop-critica.com/wp-content/uploads/2014/07/neca-scalers-series-3-line-up.jpg>. Retrieved Nov. 13, 2015.*
 Internet printout from <http://necaonline.com/45762/licenses/movies/gremlins/scalers-collectible-mini-figures-wave-1-assortment-case-48>, retrieved on Aug. 20, 2014 (1 page).
 Internet printout from http://ecx.images-amazon.com/images/I/41n%2BAA4IB6L._SY300_.jpg, retrieved on Aug. 20, 2014 (1 page).
 Image of cable device holder printed on the Internet from <https://i00.i.aliimg.com/wsphoto/v0/698765900/Free-Shipping12pcs-lot-cute-...> (first date of publication unknown; known about at least as early as Jun. 6, 2013) (1 page).
 Image of cable device holder printed on the Internet from <https://media02.hongkiat.com/gadget-cables-holders-organizers-you-can-buy/> (first date of publication unknown; known about at least as early as Jun. 6, 2013) (1 page).
 Image of cable device holder printed on the Internet from https://images2.cableorganizer.com/animal-clips/images/01-animal-clip_chick... (first date of publication unknown; known about at least as early as Jun. 6, 2013) (1 page).
 Image of cable device holder printed on the Internet from <http://www.thinkgeek.com> (first date of publication unknown; known about at least as early as Aug. 5, 2013) (1 page).
 Notice of Allowance dated Sep. 2, 2014, issued in connection with U.S. Appl. No. 29/467,983 (10 pages).
 Notice of Allowance dated Dec. 4, 2014, issued in connection with U.S. Appl. No. 29/467,983 (9 pages).
 Office Action mailed Nov. 27, 2015, issued in connection with U.S. Appl. No. 29/509,703 (9 pages).
 Office Action mailed Nov. 27, 2015, issued in connection with U.S. Appl. No. 29/509,708 (8 pages).

* cited by examiner

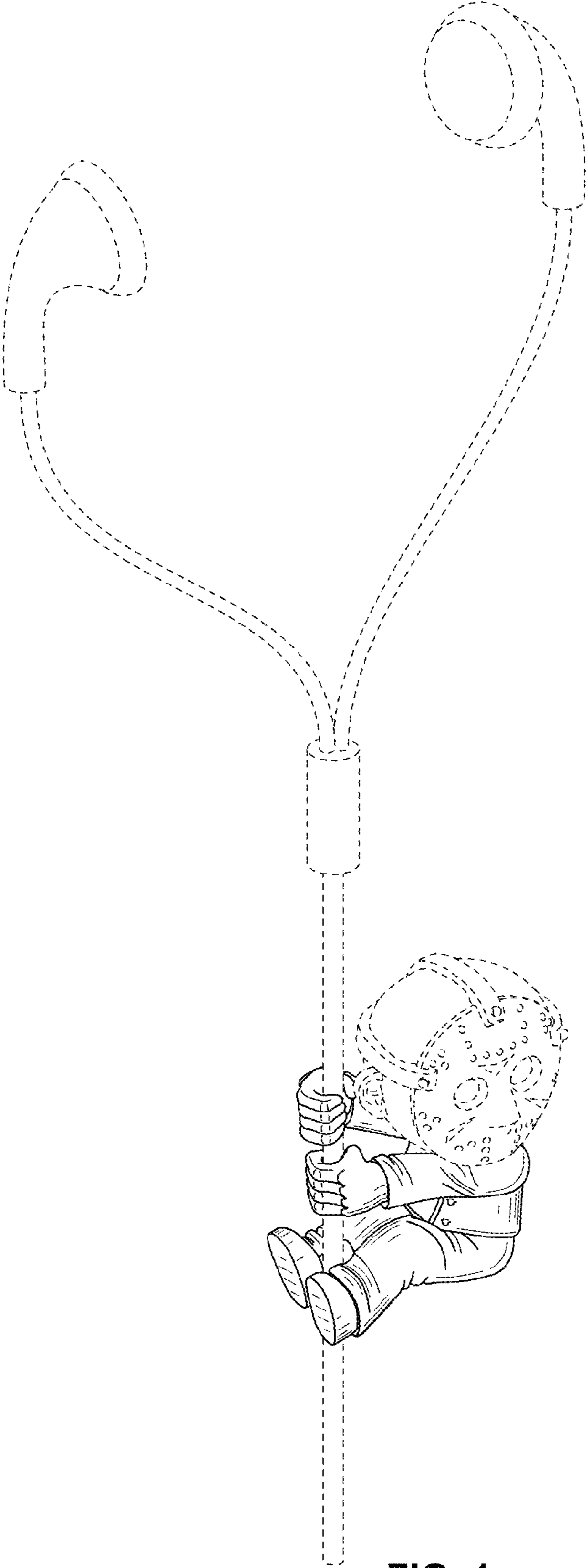

FIG. 1

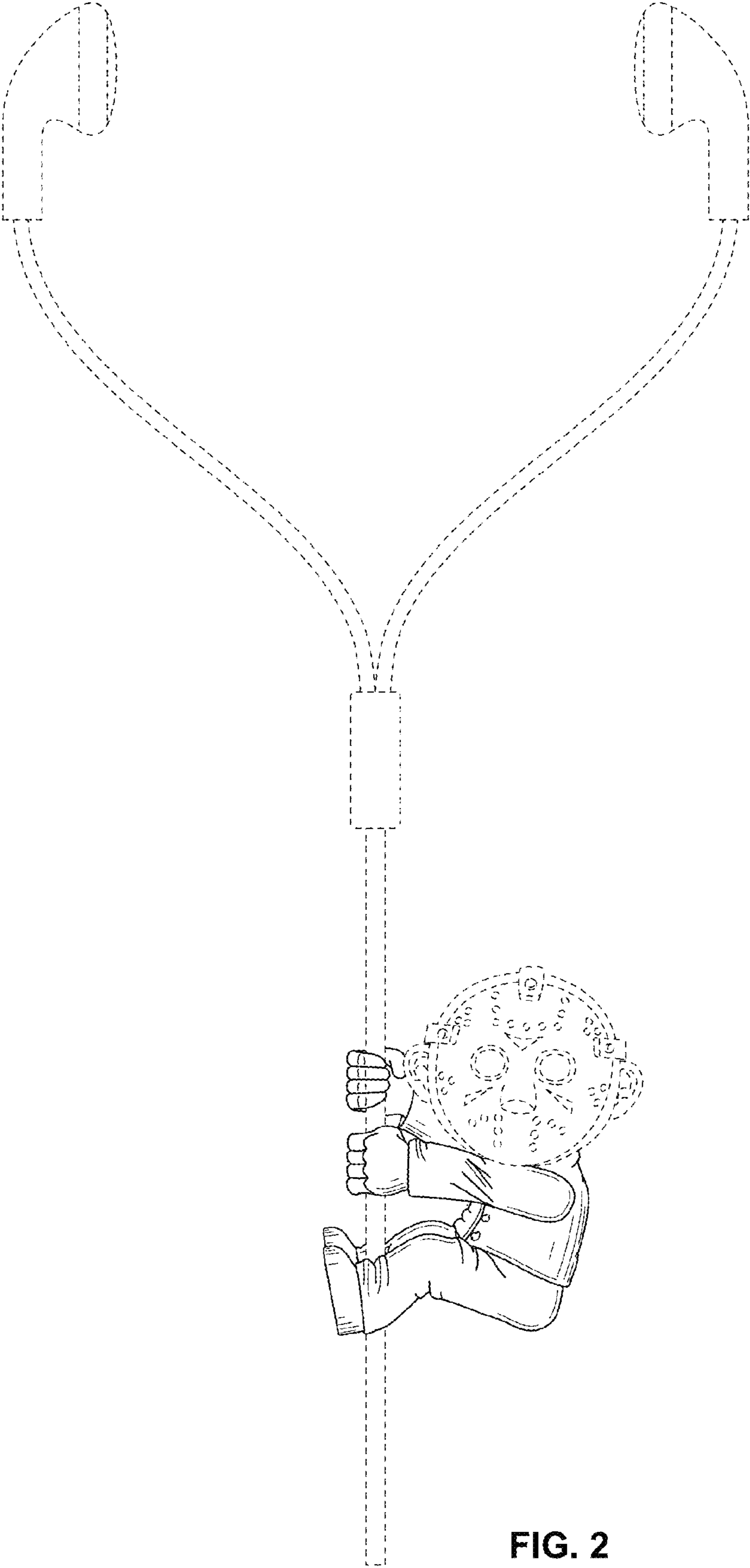

FIG. 2

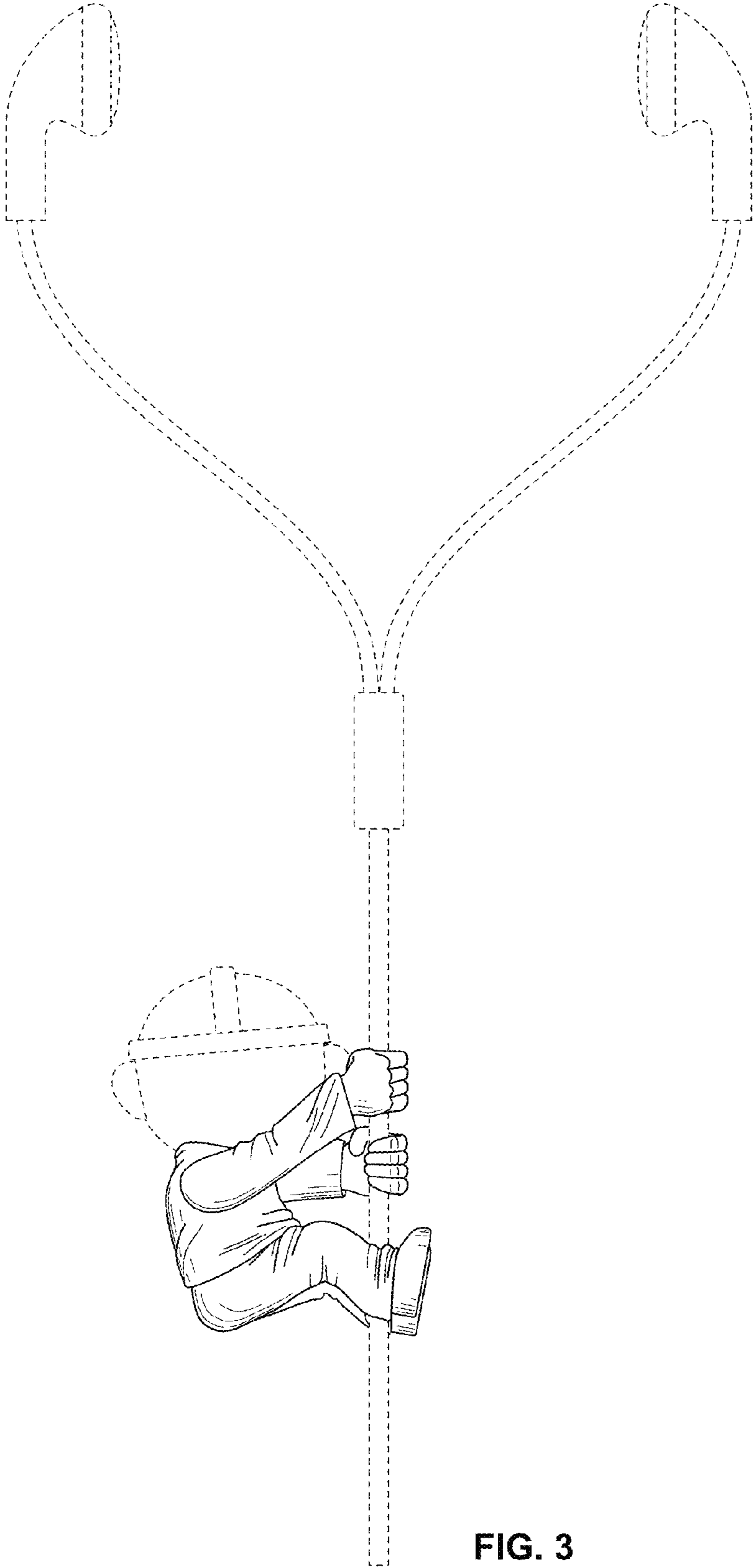
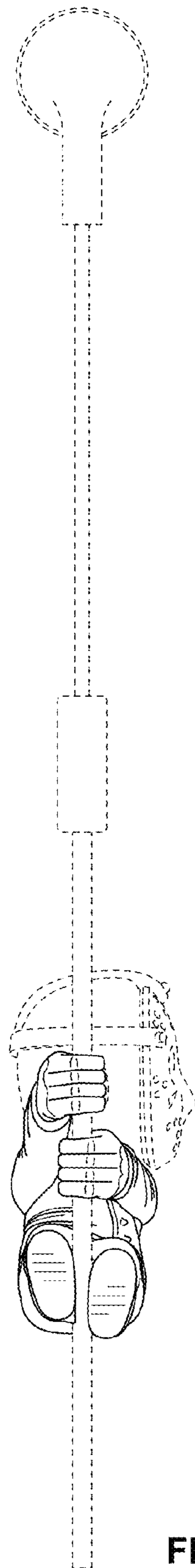
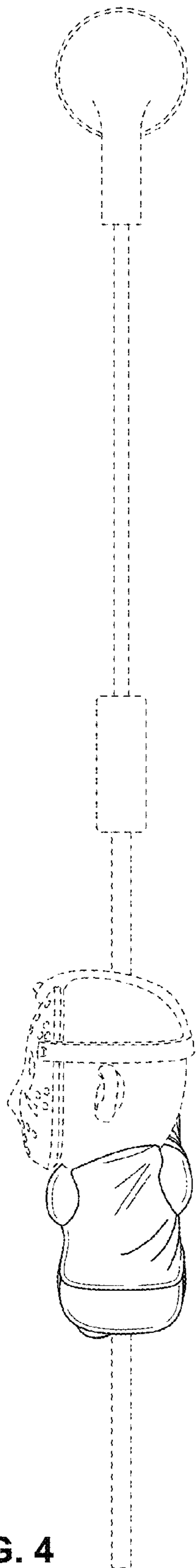

FIG. 3



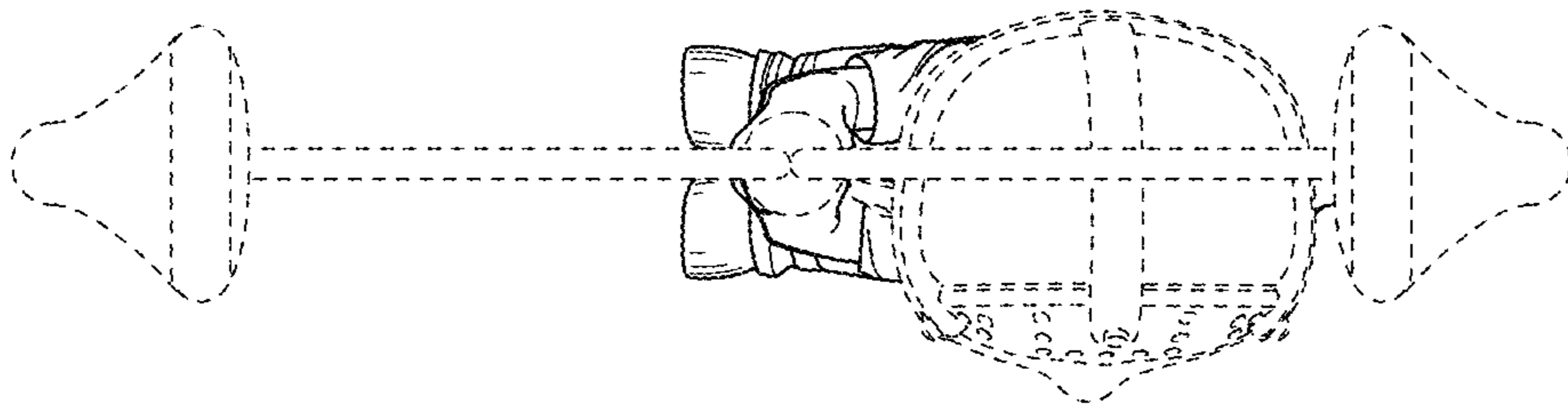

FIG. 6

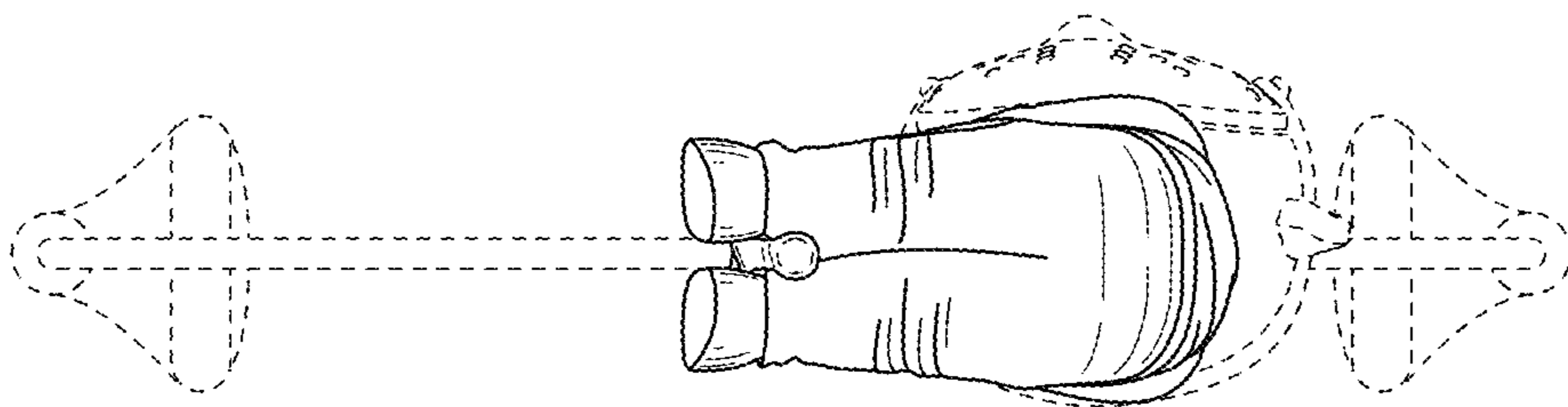

FIG. 7