

US00D762050S

(12) **United States Design Patent**
Gavrieli et al.

(10) **Patent No.:** **US D762,050 S**
(45) **Date of Patent:** **** *Jul. 26, 2016**

(54) **PURPLE SOLE AND MIDSOLE ASSEMBLY FOR A SINGLE-SOLE SHOE**

(71) Applicant: **Gavrieli Brands, LLC**, Beverly Hills, CA (US)

(72) Inventors: **Kfir Gavrieli**, Los Angeles, CA (US);
Dikla Gavrieli, Los Angeles, CA (US)

(73) Assignee: **Gavrieli Brands LLC**, Beverly Hills, CA (US)

(*) Notice: This patent is subject to a terminal disclaimer.

(**) Term: **14 Years**

(21) Appl. No.: **29/493,450**

(22) Filed: **Jun. 10, 2014**

(51) **LOC (10) Cl.** **02-99**

(52) **U.S. Cl.**
USPC **D2/950**

(58) **Field of Classification Search**
USPC D2/896, 900, 919-921, 925, 939, 947,
D2/950, 969, 971; 36/1, 83, 8.1-8.3, 9 R,
36/45-58, 104, 108, 76 R
CPC A43B 21/00; A43B 21/02; A43B 21/06;
A43B 9/14; A43B 1/0045; A43B 13/10;
A43B 13/12; A43B 23/06; A43B 23/07;
A43B 1/0036; A43B 5/12

See application file for complete search history.

(56) **References Cited**

U.S. PATENT DOCUMENTS

249,086 A 11/1881 Pienovi
773,850 A 11/1904 Cooper et al.

(Continued)

FOREIGN PATENT DOCUMENTS

DE 20 2006 000230 U1 5/2007
GB 2443937 A 5/2008

(Continued)

OTHER PUBLICATIONS

Examination Report for AU 341324, 3 pgs., dated Oct. 24, 2012.

(Continued)

Primary Examiner — Dominic Simone

(74) *Attorney, Agent, or Firm* — Morgan, Lewis & Bockius LLP

(57) **CLAIM**

The ornamental design for a purple sole and midsole assembly for a single-sole shoe, as shown and described.

DESCRIPTION

The file of this patent contains at least one drawing executed in color. Copies of this patent with color drawing(s) will be provided by the Office upon request and payment of the necessary fee.

FIG. 1 is a perspective view of a purple sole and midsole assembly for a single-sole shoe shaded to show the color purple, showing our new design;

FIG. 2 is a first side view thereof;

FIG. 3 is a second side view thereof;

FIG. 4 is a top view thereof;

FIG. 5 is a bottom view thereof;

FIG. 6 is a front view thereof;

FIG. 7 is a back view thereof;

FIG. 8 is a perspective view of another embodiment of our new design of a purple sole and midsole assembly for the single-sole shoe of FIG. 1, illustrated in conjunction with a disclaimed shoe upper, where the purple portions are indicated using the USPTO convention of dashed vertical lines for violet or purple;

FIG. 9 is a first side view thereof;

FIG. 10 is a second side view thereof;

FIG. 11 is a top view thereof;

FIG. 12 is a bottom view thereof;

FIG. 13 is a front view thereof; and,

FIG. 14 is a back view thereof.

The broken lines illustrating the shoe upper are for environmental purposes only and form no part of the claimed design.

1 Claim, 12 Drawing Sheets
(5 of 12 Drawing Sheet(s) Filed in Color)

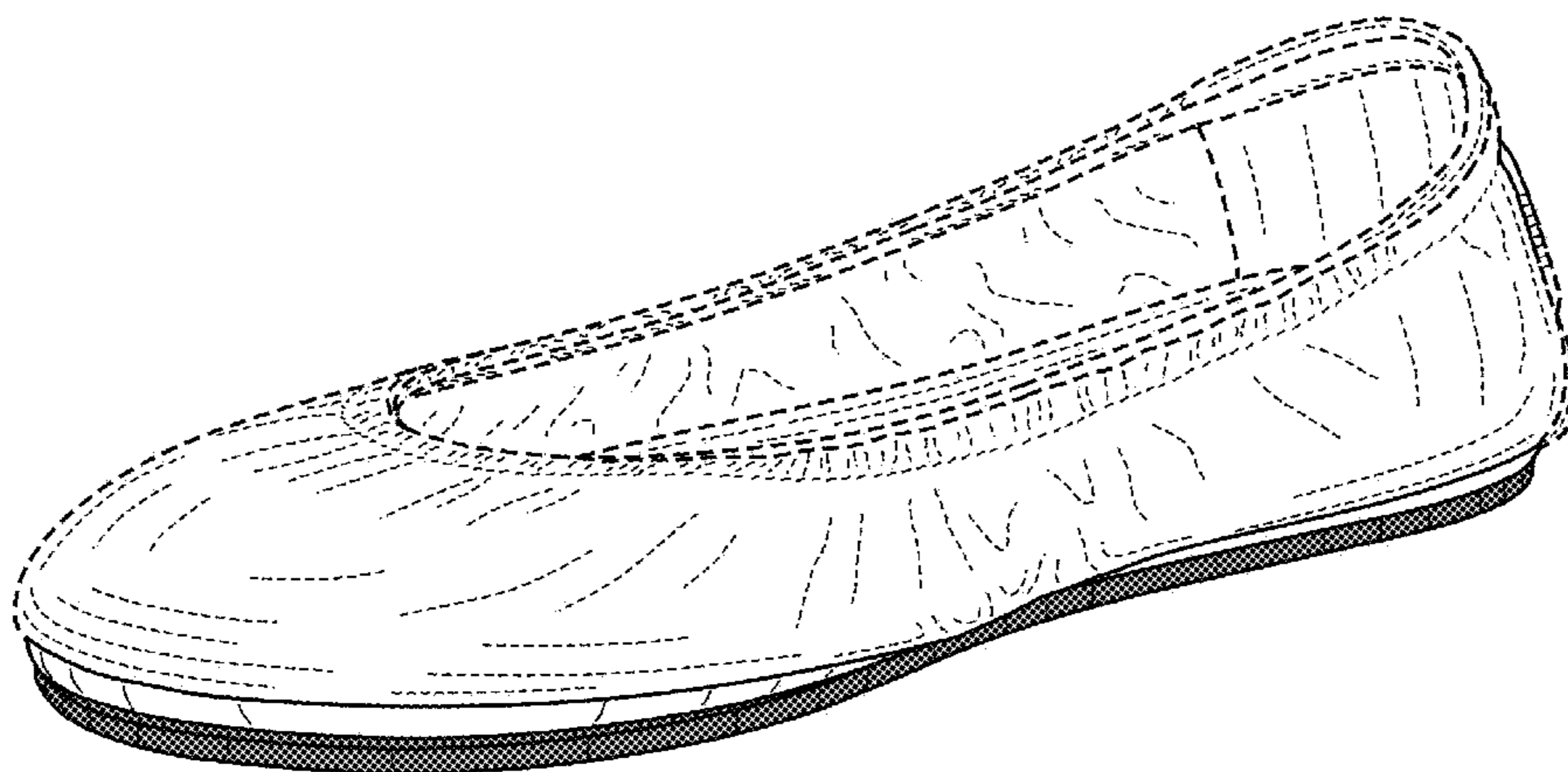

(56)

References Cited

U.S. PATENT DOCUMENTS

830,941	A	9/1906	Walden		D593,307	S	*	6/2009	Belley	D2/969
1,208,209	A	12/1916	Prince		D599,093	S	*	9/2009	Issler	D2/925
1,214,666	A	2/1917	Ford		D604,030	S		11/2009	Wilson		
1,519,009	A	12/1924	Reina		D607,194	S		1/2010	Zagula		
1,525,848	A	* 2/1925	Bonaventure A43B 5/12 36/113	D610,332	S		2/2010	Raichle		
1,587,377	A	6/1926	Grosjean		D610,785	S		3/2010	Smith		
1,650,466	A	11/1927	Righter		D612,140	S		3/2010	Moon		
2,224,590	A	12/1940	Boivin		D612,141	S		3/2010	Moon		
2,268,777	A	1/1942	Scholl		7,694,435	B1		4/2010	Kiser et al.		
D133,819	S	* 9/1942	Harris D2/939	D615,737	S		5/2010	Feller		
D135,791	S	6/1943	Beebe		7,735,244	B1		6/2010	Ameche		
2,323,563	A	7/1943	Nugent		7,743,530	B2		6/2010	Truelsen		
2,342,882	A	2/1944	Meltzer		D618,891	S		7/2010	McClaskie		
D141,871	S	7/1945	Braun		7,757,408	B2		7/2010	McClaskie		
2,383,585	A	8/1945	Bindner		D630,829	S		1/2011	Weisner		
D149,685	S	* 5/1948	Sandler D2/935	D632,881	S		2/2011	Rosenberg		
D150,729	S	* 8/1948	Sandler D2/923	7,926,203	B2		4/2011	Wilkenfeld		
D166,090	S	* 3/1952	Maling D2/897	7,966,747	B2		6/2011	Wilkenfeld et al.		
2,772,488	A	12/1956	Meltzer		D640,861	S		7/2011	Wilkenfeld		
2,904,814	A	9/1959	Scholl		8,020,320	B2		9/2011	Gillespie		
3,148,378	A	9/1964	Tibbitts		8,127,468	B2		3/2012	Morgan		
D200,897	S	* 4/1965	Mitchell D2/919	D657,543	S		4/2012	Bove		
D220,464	S	4/1971	Hayoshi		D659,960	S		5/2012	Bizzo		
D247,396	S	* 3/1978	Schlerth D2/939	8,230,619	B2		7/2012	Salvatelli		
4,412,393	A	11/1983	Terlizzi, Jr. et al.		D664,755	S		8/2012	Gavrieli et al.		
D275,525	S	9/1984	Nakao		D665,157	S		8/2012	Wu		
4,674,206	A	6/1987	Lyden		8,240,067	B2		8/2012	Sussmann		
D295,692	S	* 5/1988	Zuidema D2/950	8,245,420	B2		8/2012	Wilson		
D300,085	S	3/1989	Ito et al.		D668,027	S		10/2012	Millieret		
RE33,018	E	8/1989	Ostrander		D668,438	S		10/2012	Millieret		
4,899,412	A	2/1990	Ganon		D668,847	S	*	10/2012	Gavrieli	D2/925
D316,773	S	5/1991	Valle		D668,848	S	*	10/2012	Gavrieli	D2/925
5,012,541	A	5/1991	Ganon		D668,849	S		10/2012	Pozzi		
D339,669	S	* 9/1993	Miller D2/919	D668,850	S		10/2012	Pozzi		
5,282,326	A	2/1994	Schroer, Jr. et al.		D672,542	S		12/2012	Gray et al.		
5,421,050	A	6/1995	Laganas		D676,634	S	*	2/2013	Gavrieli	D2/925
5,699,629	A	12/1997	Munschy		D681,927	S	*	5/2013	Gavrieli	D2/925
5,746,014	A	5/1998	Tanemoto		D681,928	S	*	5/2013	Gavrieli	D2/925
D420,785	S	2/2000	Perez		D681,929	S	*	5/2013	Gavrieli	D2/925
6,055,745	A	5/2000	Endoh		D683,936	S	*	6/2013	Gavrieli	D2/925
6,076,284	A	6/2000	Terlizzi		8,468,723	B2		6/2013	Malka-Harari		
6,189,239	B1	2/2001	Gasparovic et al.		8,510,975	B2		8/2013	Krikelis		
6,338,207	B1	1/2002	Chang		D688,853	S	*	9/2013	Gavrieli	D2/925
D457,292	S	* 5/2002	Sessa D2/949	D688,854	S	*	9/2013	Gavrieli	D2/925
D461,947	S	8/2002	Merceron		D688,855	S	*	9/2013	Gavrieli	D2/925
D476,798	S	7/2003	Reynolds et al.		D689,270	S	*	9/2013	Gavrieli	D2/925
6,588,124	B2	7/2003	Morrone		D689,271	S	*	9/2013	Gavrieli	D2/925
D498,041	S	11/2004	McClaskie		D689,272	S	*	9/2013	Gavrieli	D2/925
D500,191	S	* 12/2004	Belley D2/969	D690,914	S	*	10/2013	Gavrieli	D2/925
D501,706	S	2/2005	McClaskie		D690,915	S	*	10/2013	Gavrieli	D2/925
6,857,203	B2	2/2005	Minden		D696,500	S		12/2013	Hunt		
6,895,693	B2	5/2005	Baruck		D699,424	S		2/2014	Hamm		
6,978,557	B2	12/2005	Lee		8,661,714	B2		3/2014	Sussman		
7,032,327	B1	4/2006	Tartaglia et al.		8,973,287	B2		3/2015	Shibata		
7,036,244	B1	5/2006	Finch		2002/0078591	A1		6/2002	Morrone		
D527,513	S	9/2006	Della Valle		2002/0129519	A1		9/2002	Cahan		
D529,513	S	* 10/2006	Aketa D15/5	2003/0070319	A1		4/2003	Minden		
D531,790	S	11/2006	Wurzburg		2003/0121176	A1		7/2003	Baruck		
D534,341	S	* 1/2007	Choi D2/896	2004/0025377	A1		2/2004	Brannon		
D542,513	S	5/2007	Amado et al.		2005/0022421	A1		2/2005	Bruckner		
D556,990	S	12/2007	Cabados		2005/0115115	A1		6/2005	Lacey		
7,337,558	B2	3/2008	Terlizzi et al.		2005/0217148	A1		10/2005	Connolly et al.		
D567,485	S	4/2008	James		2005/0262734	A1		12/2005	Cheng		
D570,488	S	6/2008	Kirksey et al.		2006/0086005	A1		4/2006	Yerian		
D571,084	S	6/2008	Comeau		2006/0156576	A1		7/2006	Sloan		
D571,548	S	6/2008	Seamans		2007/0074424	A1		4/2007	Lin		
D571,989	S	7/2008	Siegal		2007/0204482	A1		9/2007	Gibson-Collinson		
D580,640	S	11/2008	Wurzburg		2007/0204483	A1		9/2007	Kirsch et al.		
D582,638	S	12/2008	Ringholz		2008/0052964	A1		3/2008	Taylor		
7,496,982	B2	3/2009	Clark et al.		2008/0086912	A1		4/2008	Wilkenfeld		
7,506,459	B2	3/2009	Grisoni et al.		2008/0110059	A1		5/2008	Kuramoto et al.		
D591,031	S	4/2009	Cofinco		2009/0019732	A1		1/2009	Sussmann		
D593,295	S	* 6/2009	Belley D2/969	2009/0193685	A1		8/2009	Wilson		
D593,297	S	* 6/2009	Belley D2/969	2009/0205222	A1		8/2009	McLinden		
					2009/0272009	A1		11/2009	Weisner et al.		
					2010/0011625	A1		1/2010	Percival		
					2010/0018080	A1		1/2010	Smith		
					2010/0050469	A1		3/2010	Chen		
					2010/0095557	A1		4/2010	Jarvis		

(56)

References Cited

U.S. PATENT DOCUMENTS

2010/0115793	A1	5/2010	Kraisosky
2010/0122475	A1	5/2010	Purrington
2010/0146822	A1	6/2010	MacGregor
2010/0212186	A1	8/2010	Cheng
2010/0275462	A1	11/2010	Pucci
2010/0281713	A1	11/2010	Pantazes
2015/0089843	A1	4/2015	Gavrieli

FOREIGN PATENT DOCUMENTS

GB	2 446 205 A	8/2008
TW	D119165	10/2007

OTHER PUBLICATIONS

- Letter from TMI and Associates with Office Action, 2 pgs, dated Sep. 19, 2012 <http://www.payless.com/store/?&TLC=Womens&SLC=WomensNewArrivals&BLC=WomensNewArrivalsNewArrivals&With+Regular&ItemCode=60131&LotNumber=062642&Type=Adult&Popularity=637&Descriptvein>
- Taiwanese Office Action for TW 101300726, 10 pgs., dated Sep. 6, 2012.
- “The Love List, Tieks by Gavrieli—Foldable Ballet Flats,” <http://thelovelist-carly.blogspot.com.au/2010/09/tieks-by-gavrieli-foldable-ballet.html>, 3 pgs., Sep. 12, 2010.
- “Tieks by Gavrieli,” <http://tieks.com>, 1 pg., retrieved Mar. 13, 2013 from URL.
- “Try It Mummy!, Tieks by Gavrieli,” <http://tryitmummy.blogspot.com.au/2010/12/tieks-by-gavrieli.html>, 4 pgs., Dec. 9, 2010.
- “Wearability—Real People Style, What came first, the City Flat or the Tieks,” <http://wearability.posterous.com/what-came-first-the-city-flat-or-the-tieks>, 4 pgs., Aug. 29, 2010.
- “The Ballet Flat . . . Reinvented; Ballet Flats . . . with a Bonus; Step Into Tieks; Going Places? Take Tieks,” <http://web.archive.org/web/2010052004346/http://www.tieks.com/>; 4 pgs., May 24, 2010.
- “Tieks—Comfortable designer flats you can fit in your purse and wear all day, every day,” <http://web.archive.org/web/20110731151555/http://tieks.com/>; 6 pgs., Jul. 31, 2011.
- “58th Annual Emmy Awards,” http://spoonsforksandfashion.blogspot.com/2006_08_01_archive.html, depicting Nine West flats, 11 pgs., Aug. 1, 2006.
- Pictures of Nine West flats sold in 2006, 3 pgs.
- “I Love a Good Ballet Flat!,” <http://dressupfiles.com/i-love-a-good-ballet-flat>, depicting Sue London flats, 4 pgs., Sep. 3, 2010.
- Pictures of Sue London flats sold in 2010, 2 pgs.
- “Miss Cathie Reviews: The Yosi Samra Foldable Ballet Flat . . .,” <http://www.misscathie.com/2010/01/miss-cathie-reviews-the-yosi-samra-foldable-ballet-flat/>, depicting Yosi Samra flats, 7 pgs., Jan. 2010.
- Pictures of Yosi Samra flats sold in 2010, 2 pgs.
- “Goodbye two thousand ten,” http://emmajoyrussell.blogspot.com/2010_12_01_archive.html, depicting Gap flats, 39 pgs., Dec. 1, 2010.
- Pictures of Gap flats available for sale in 2010, 9 pgs.
- “Our newest design of folding flats-Pink,” <https://fitinclouds.wordpress.com/2010/05/16/our-newest-design-of-folding-flats-pink/>, depicting Fit in Clouds flats, 1 pg., May 16, 2010.
- “Fit in Clouds Satin Folding Shoes,” <http://www.goodhousekeeping.com/product-reviews/clothing/best-ballet-flats/fit-in-clouds-satin-foldable-ballet-flats>, depicting Fit in Clouds flats, 1 pg., Aug. 2013.
- Pictures of Fit in Clouds flats available for sale in 2011, 4 pgs.
- “Shoes for Standing,” <https://truthinshoes.wordpress.com/2008/07/>, depicting Sam & Libby flats, 2 pgs., Jul. 31, 2008.
- “Target Designer Collaboration: Announcing Sam & Libby Shoes for Target,” <http://www.therecessionista.com/2012/11/target-designer-collaboration-announcing-sam-libby-shoes-for-target.html>, depicting Sam & Libby flats, 1 pg., Nov. 26, 2012.
- Pictures of Sam & Libby flats available for purchase in 2011, 5 pgs.
- “Save your soles with Citisoles ballet flats,” <http://glamazondiaries.com/2009/07/save-your-soles-with-citisoles-ballet-flats>, depicting Citisoles flats, 3 pgs., Jul. 2009.
- Pictures of Citisoles flats available for purchase in 2009, 3 pgs.
- “#16 Corso Como Delicious Pumps Review and Giveaway!,” <http://www.mommatoldmeblog.com/2011/01/16-corso-como-delicious-pumps-review.html>, depicting Corso Como flats, 8 pgs., Jan. 16, 2011.
- Pictures of Corso Como flats available for sale in 2011, 3 pgs.
- “Jil-sander-navy-lead-ballet-flats-product . . .,” www.ebay.com, depicting Jil Sander flats, 4 pgs., Nov. 2013.
- Pictures of Jil Sander flats available for sale in 2011, 3 pgs.
- “Spare Soles: Shoes That Roll-up & Fold-up,” <http://herpackinglist.com/2011/01/spare-soles-shoes/>, depicting Spare Soles flats, 2 pgs., Jan. 2011.
- Pictures of Spare Soles flats available for sale in 2011, 5 pgs.
- The Original Rollable, Foldable ballet flats with matching wristlet—Spare Soles, <http://herpackinglist.com/2011/01/spare-soles-shoes/>, depicting Roll-Upz Spare Soles flats, 2 pgs., Jan. 2011.
- Pictures of Roll-Upz by Spare Soles flats available for sale in 2011, 6 pgs.
- “The Cutest Blog, Preppy 50 and Loving Lilly, Ballet Flat Delight,” <http://preppy50andlovinglilly.blogspot.com/2011/02/ballet-flat-delight.html>, depicting Henri Bendel flats, 13 pgs., Feb. 19, 2011.
- Pictures of Henri Bendel flats available for sale in 2011, 4 pgs.
- “Mumsnet by parents for parents,” http://www.mumsnet.com/Talk/style_and_beauty/a1612000-Anyone-tried-Redfoot-Flatmates-foldable-ballet-pumps, depicting Redfoot Flatmates flats, 1 pg, Nov. 14, 2012.
- Pictures of Redfoot Flatmates flats available for sale in 2011, 6 pgs.
- “Amazon.com: Customer Reviews: Bloch London Women’s Lux Ballet Flat,” <http://www.amazon.com/Bloch-London-Womens-Ballet-Flat/product-reviews/B004LWP7YW>, depicting Bloch London flats, 4 pgs., Dec. 11, 2011.
- Pictures of Bloch London flats offered for sale in 2011, 11 pgs.
- “h&m foldable leopard print flat,” <http://845shops.wordpress.com/2011/06/16/flats-for-7-bucks/shoe1/>, depicting h&m flats, 3 pgs., Jun. 16, 2011.
- Pictures of h&m foldable flats offered for sale in 2011, 4 pgs.
- “Seekyt—Juicy Couture Ballet Flats—Are They Worth The Money?,” <http://seekyt.com/juicy-couture-ballet-flats-are-they-worth-the-money/>, 14 pgs., Jun. 3, 2011.
- Pictures of Juicy Couture flats offered for sale in 2011, 3 pgs.
- “Purse Flats,” <http://purseflats.wordpress.com>, depicting Purse Flats by Erica Wilson, 3 pgs., Jul. 12, 2012.
- Pictures of Purse Flats by Erica Wilson offered for sale in 2011, 6 pgs.
- “Splash Page,” <http://web.archive.org/web/20100524004346/http://www.tieks.com/>, 4 pgs., May 24, 2010.
- “Tieks—Comfortable, designer flats you can fit in your purse and wear all day, every day,” <http://web.archive.org/web/20110731151555/http://tieks.com/>, 6 pgs., Jul. 31, 2011.
- “Tieks by Gavrieli—Comfortable, designer flats you can fit in your purse and wear all day . . .,” <http://web.archive.org/web/20110202210649/http://www.tieks.com/>, 8 pgs., Feb. 2, 2011.
- “Carolina M. M. Gonzalez > Tieks by Gavrieli,” http://m2.facebook.com/Tieks?v=timeline&filter=2&timecutoff=1406427986&page=17§ionLoadingID=m_timeline_loading_div_1293868799_1262332800_8_17&timeend=1293868799×tart=1262332800&tm=AQDOvqhWQPN_Nbwm&refid=17, 1 pg. Jan. 26, 2010.
- “The Shoes Oprah Would Wear to Work (if she Had to Walk),” <http://www.inc.com/30under30/christina-desmarais/kfir-gavrieli-and-elram-gavrieli-founders-of-tieks.html>, 8 pgs., Jul. 2, 2012.
- “Tieks by Gavrieli,” http://m2.facebook.com/Tieks?v=timeline&filter=2&timecutoff=1406427986&page=14§ionLoadingID=m_timeline_loading_div_1293868799_1262332800_8_14&timeend=1293868799×tart=1262332800&tm=AQDOvqhWQPN_Nbwm&refid=17, 4 pgs., Jan. 26, 2010.
- “Mighty Life List, Sensible Shoes,” <http://mightygirl.com/2010/08/24/sensible-shoes/>, 10 pgs., Aug. 24, 2010.

(56)

References Cited

OTHER PUBLICATIONS

“Find! Tieks: Fab & sexy flats for fall,” <http://thefabmom.com/2013/08/29/find-tieks-fab-sexy-flats-for-fall/>, 3 pgs. Aug. 29, 2013.

“Step into Tieks,” <http://sliceofpink.typepad.com/blog/2010/09/tieks-1.html>, 5 pgs., Sep. 22, 2010.

“In Need of Flat-Soled Shoes,” <http://sliceofpink.typepad.com/blog/2010/09/tieks-1.html>, 7 pgs., Oct. 3, 2010.

* cited by examiner

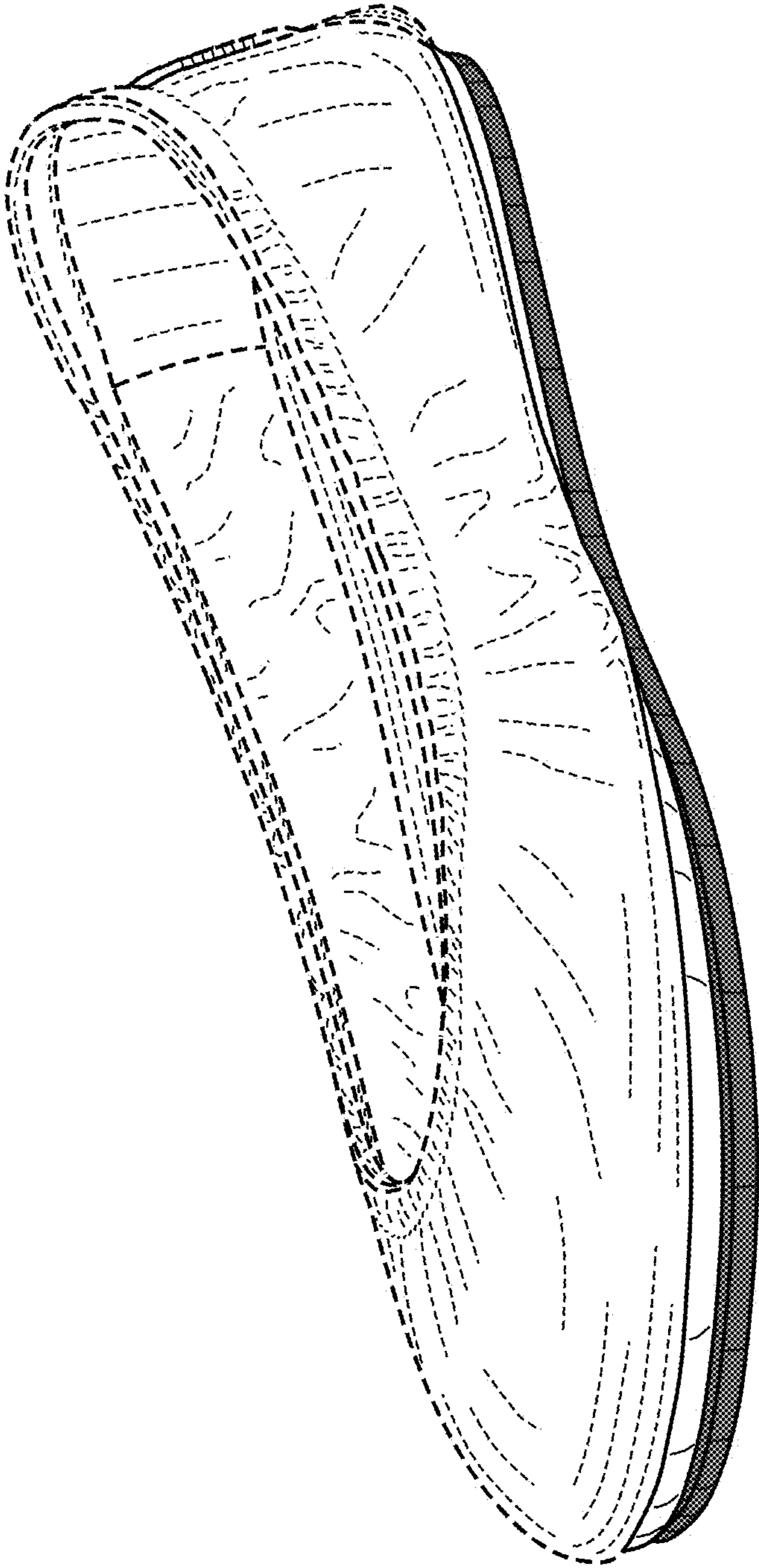

FIG. 1

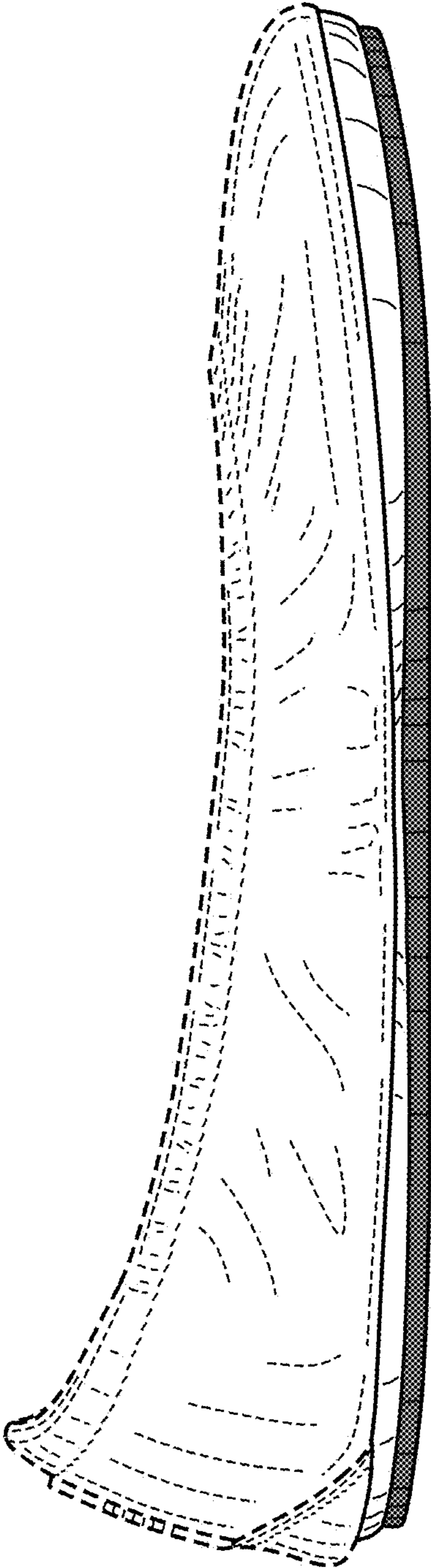

FIG. 2

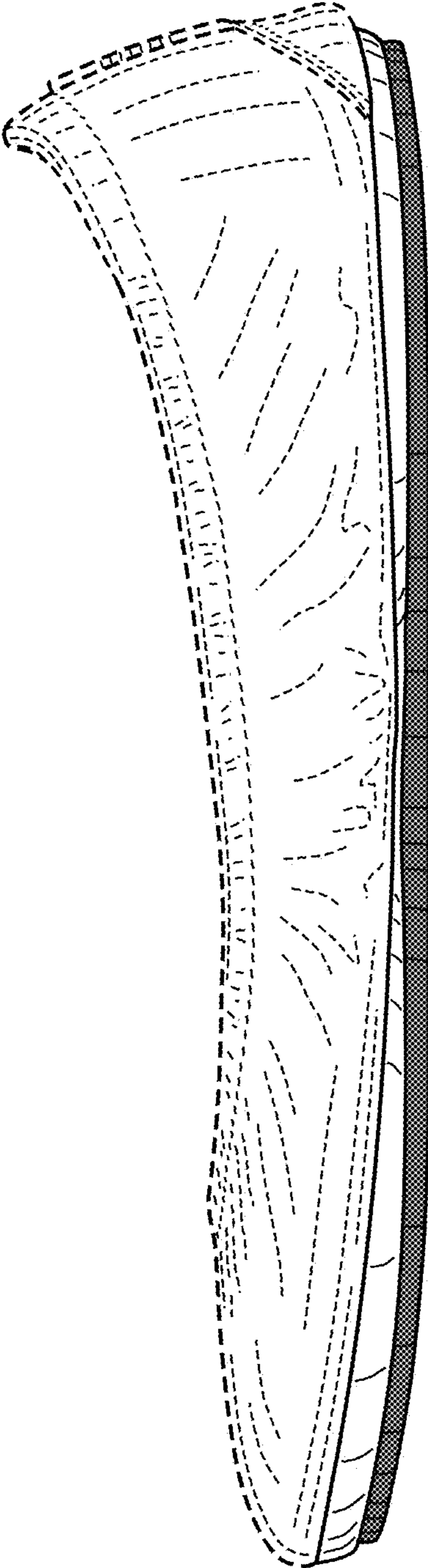

FIG. 3

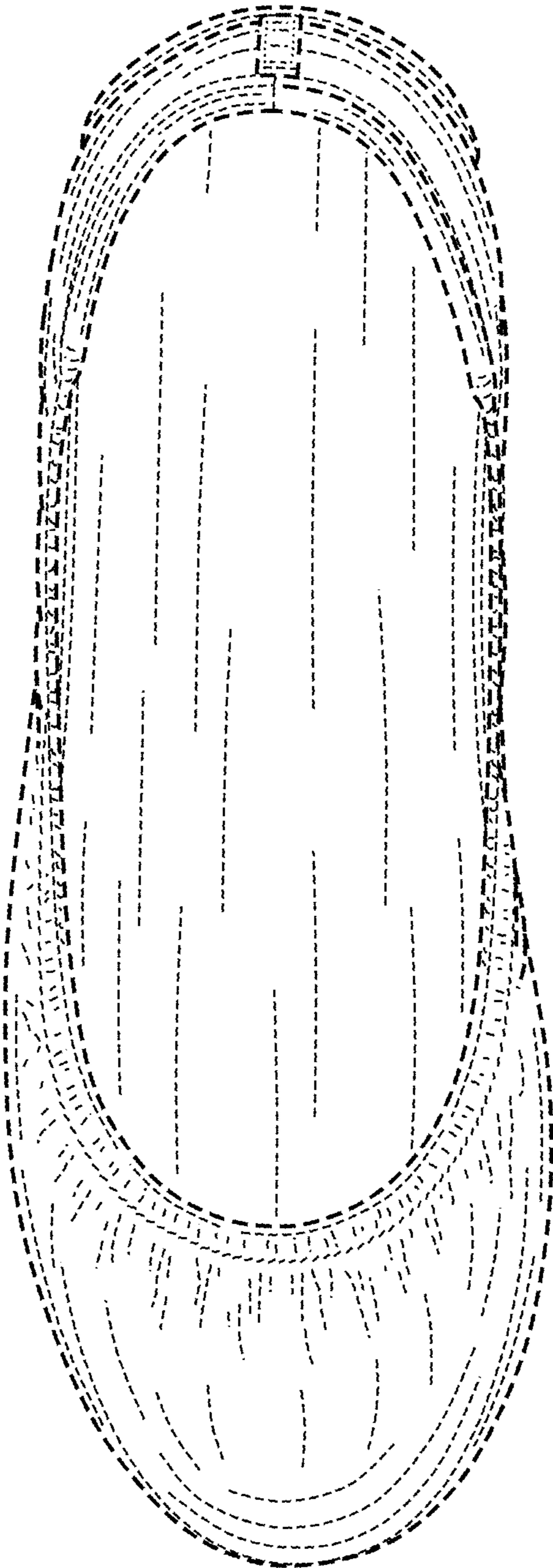

FIG. 4

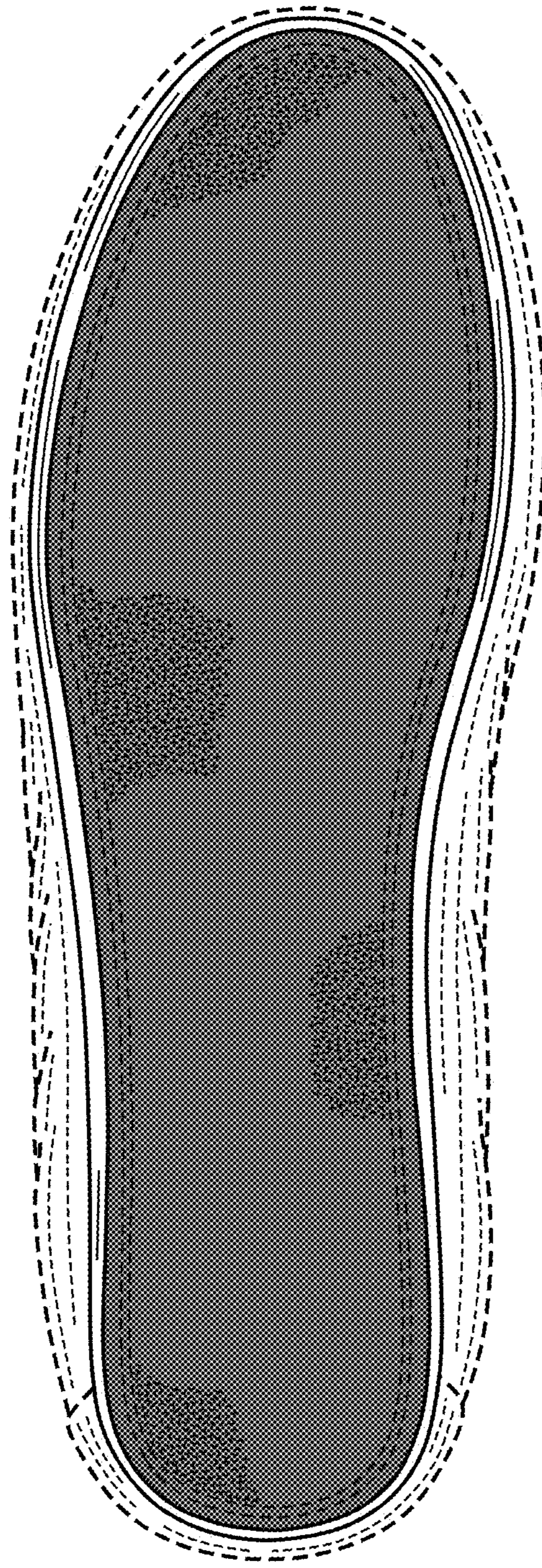

FIG. 5

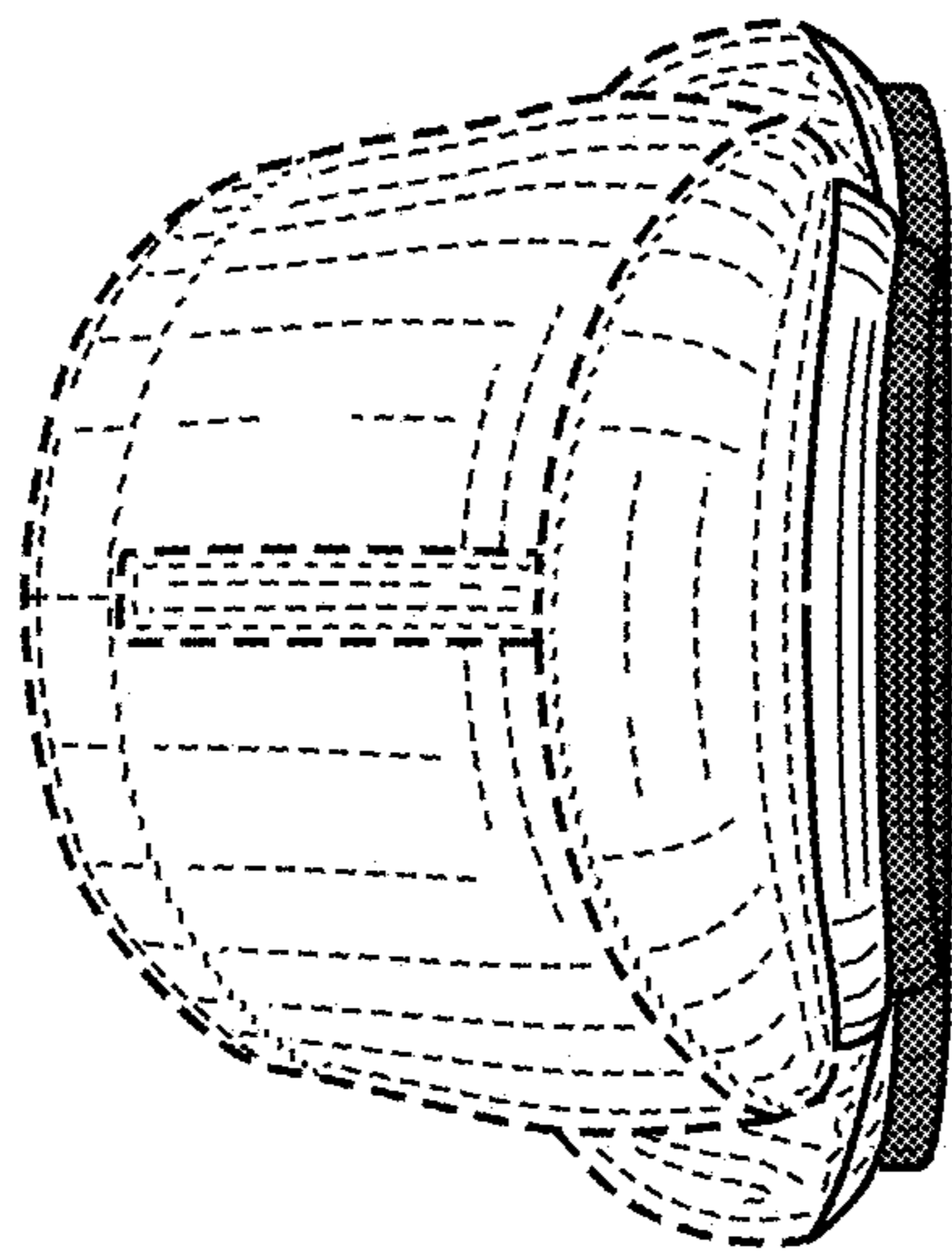

FIG. 7

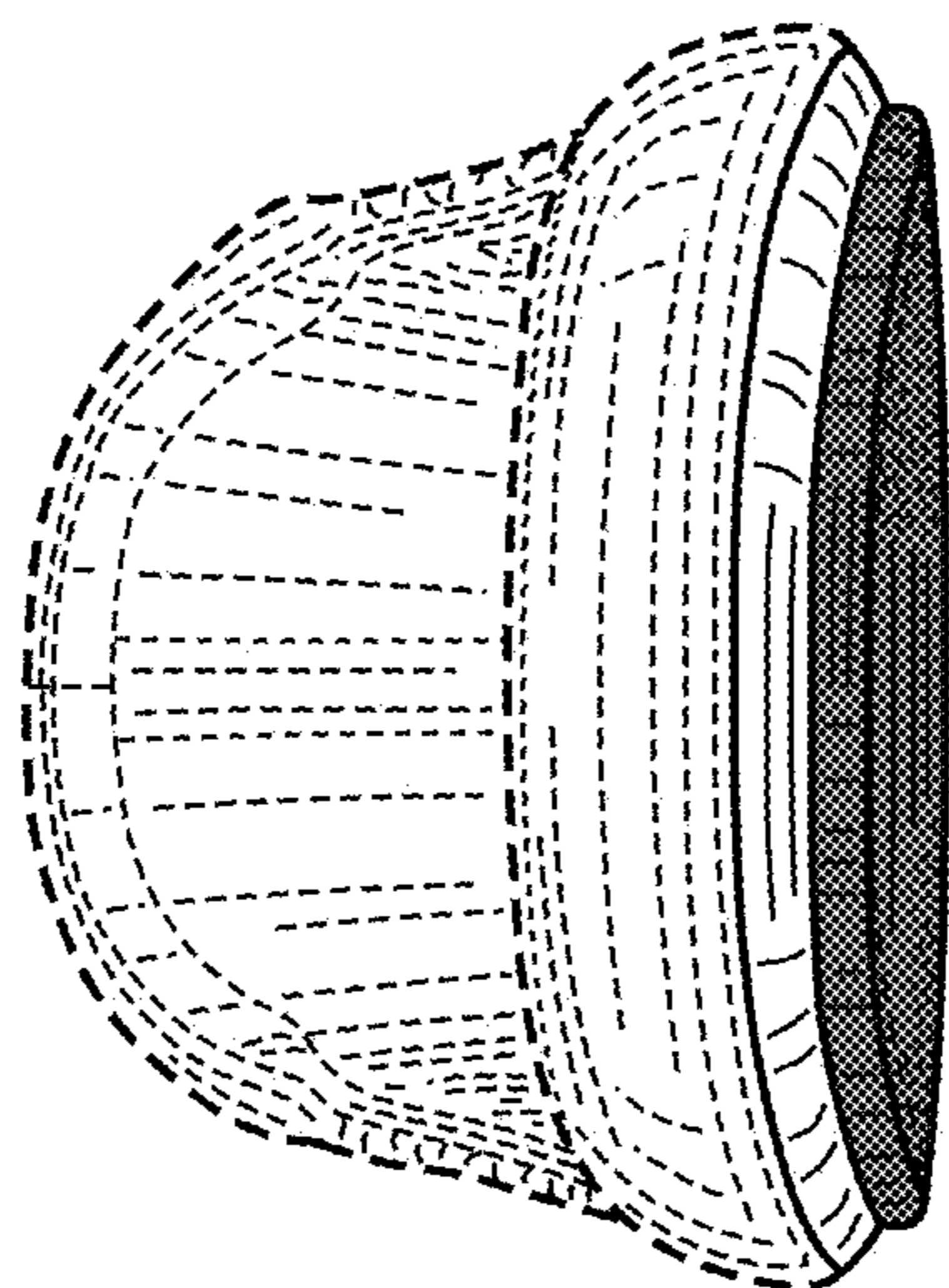

FIG. 6

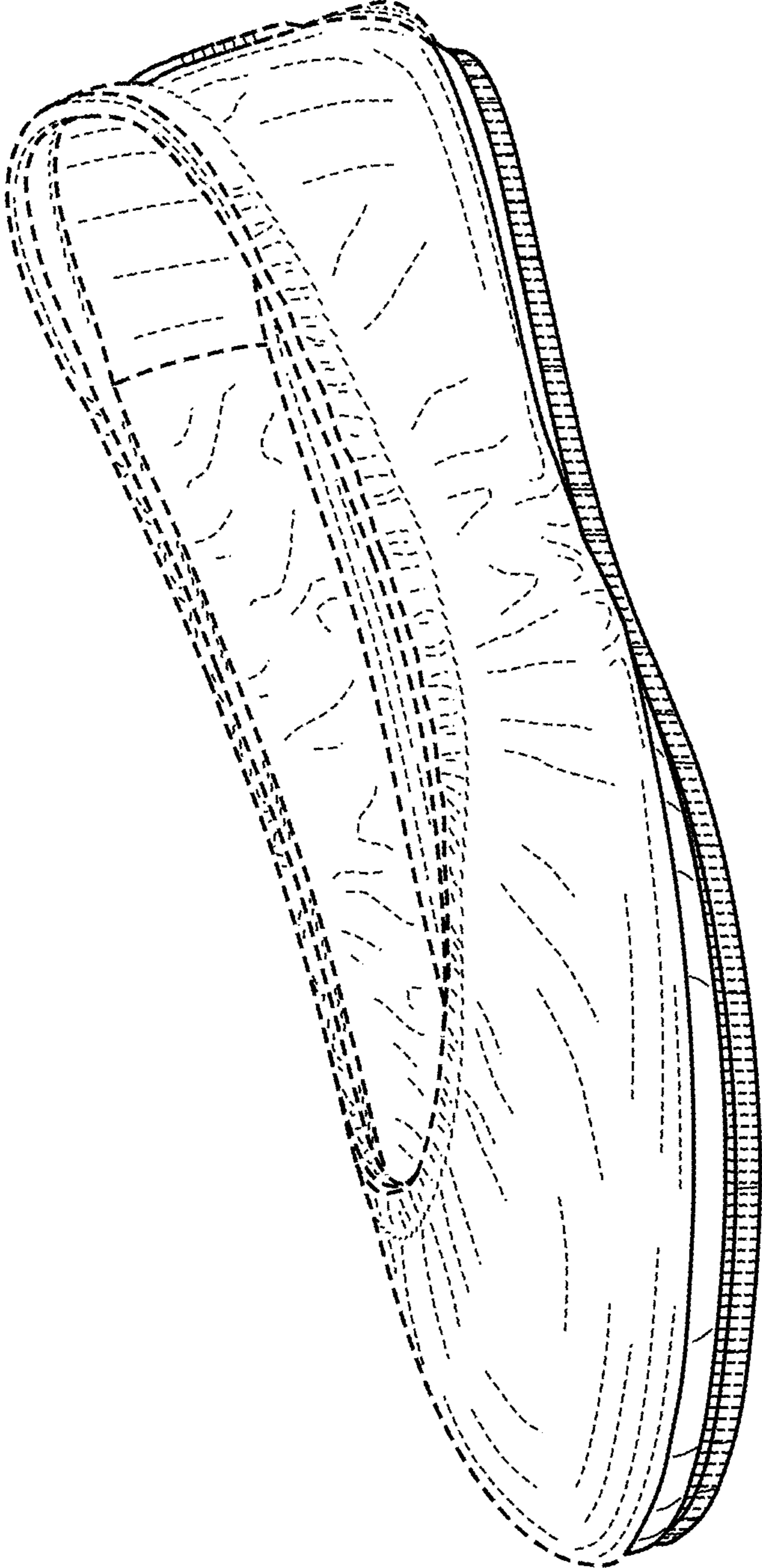

FIG. 8

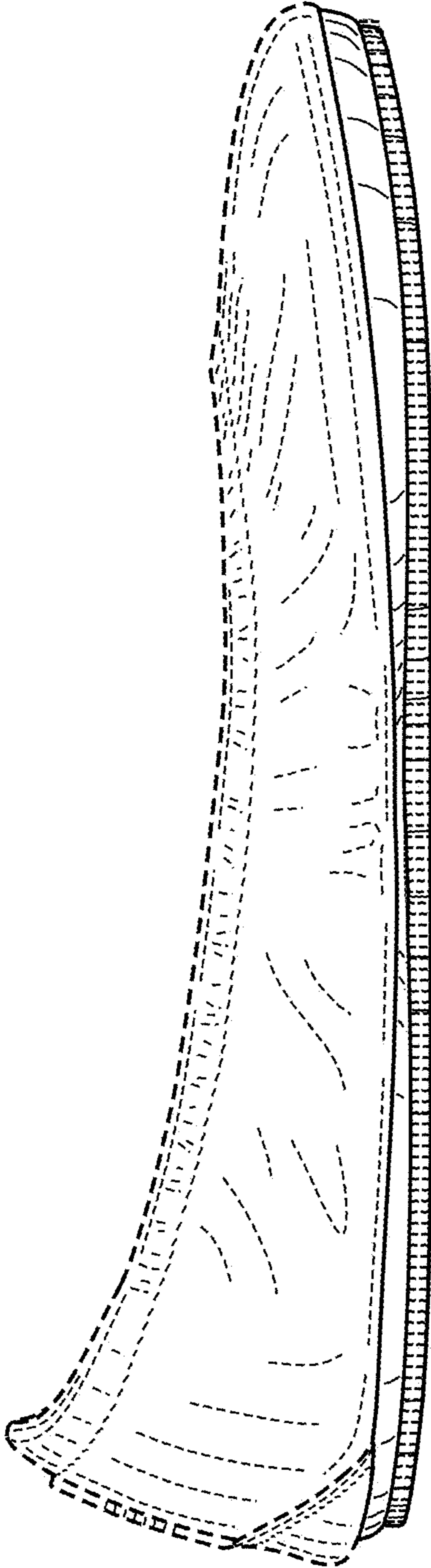

FIG. 9

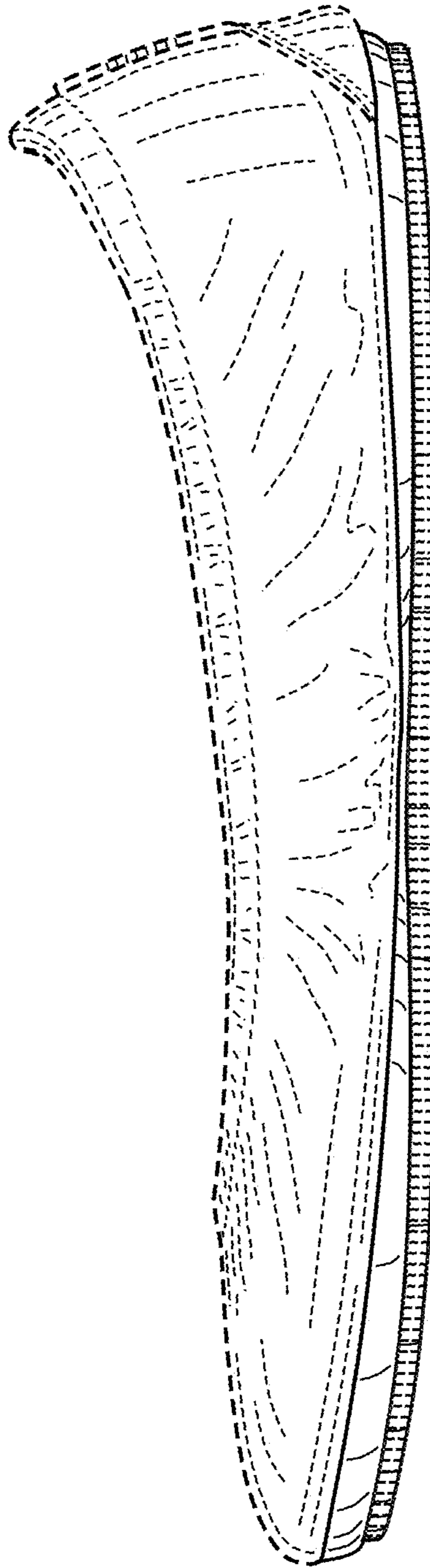

FIG. 10

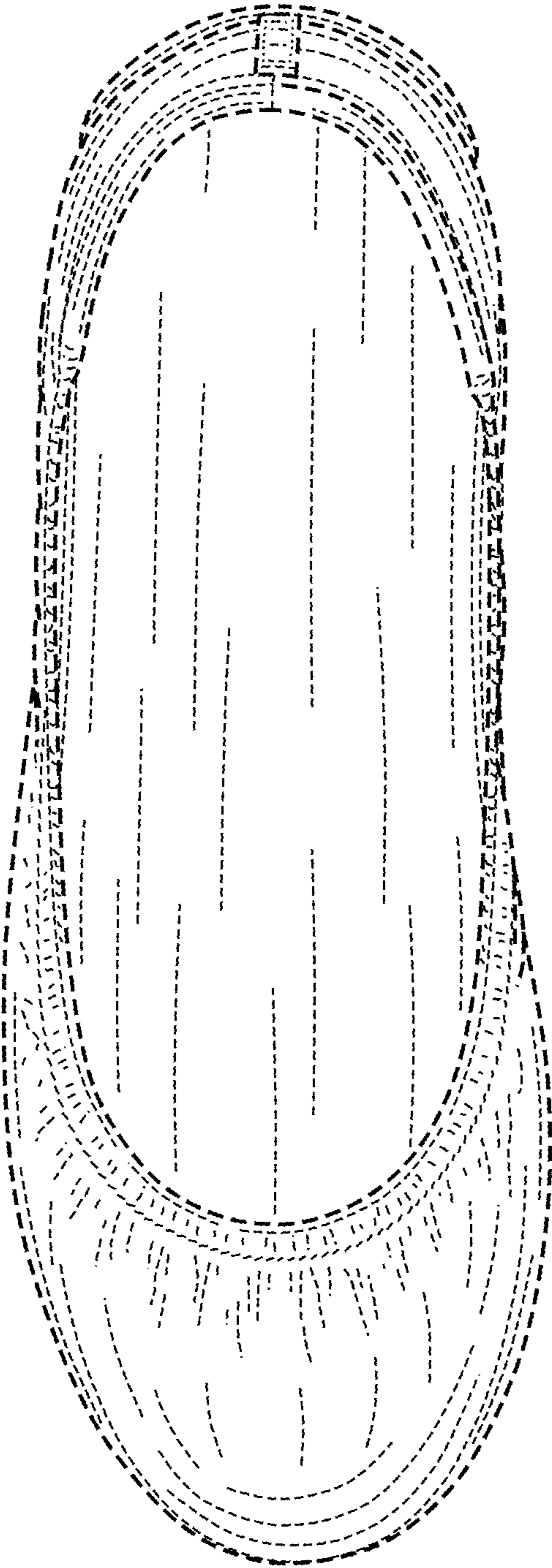

FIG. 11

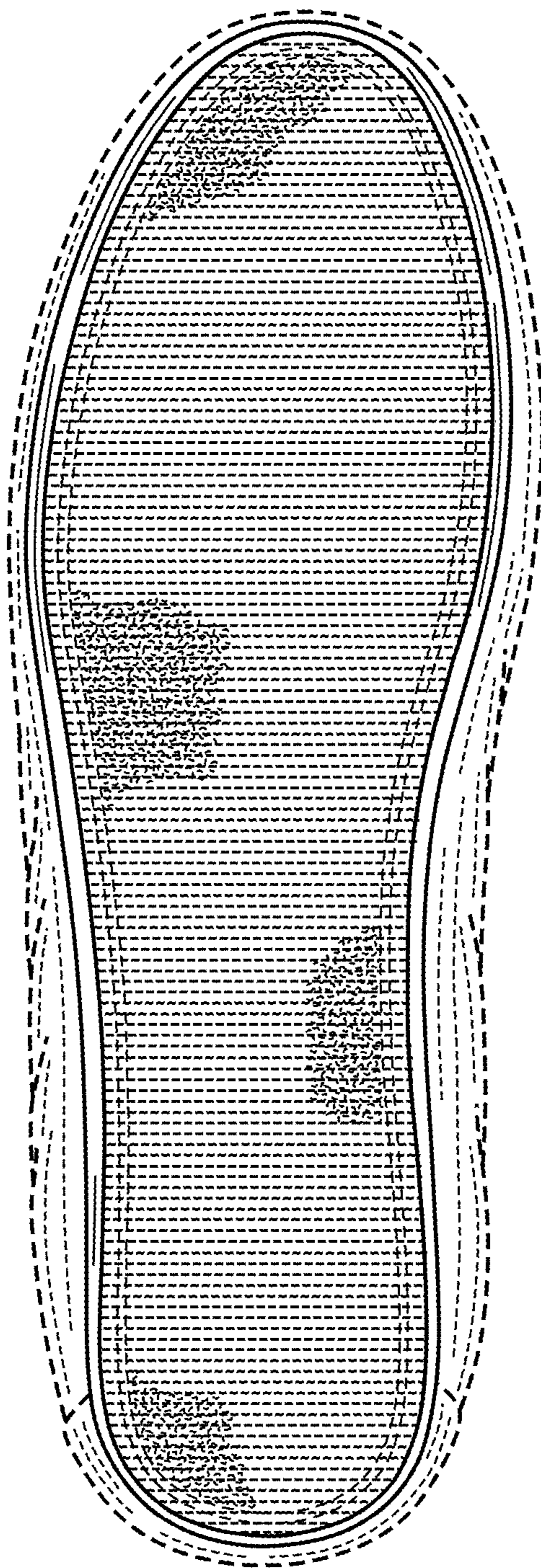

FIG. 12

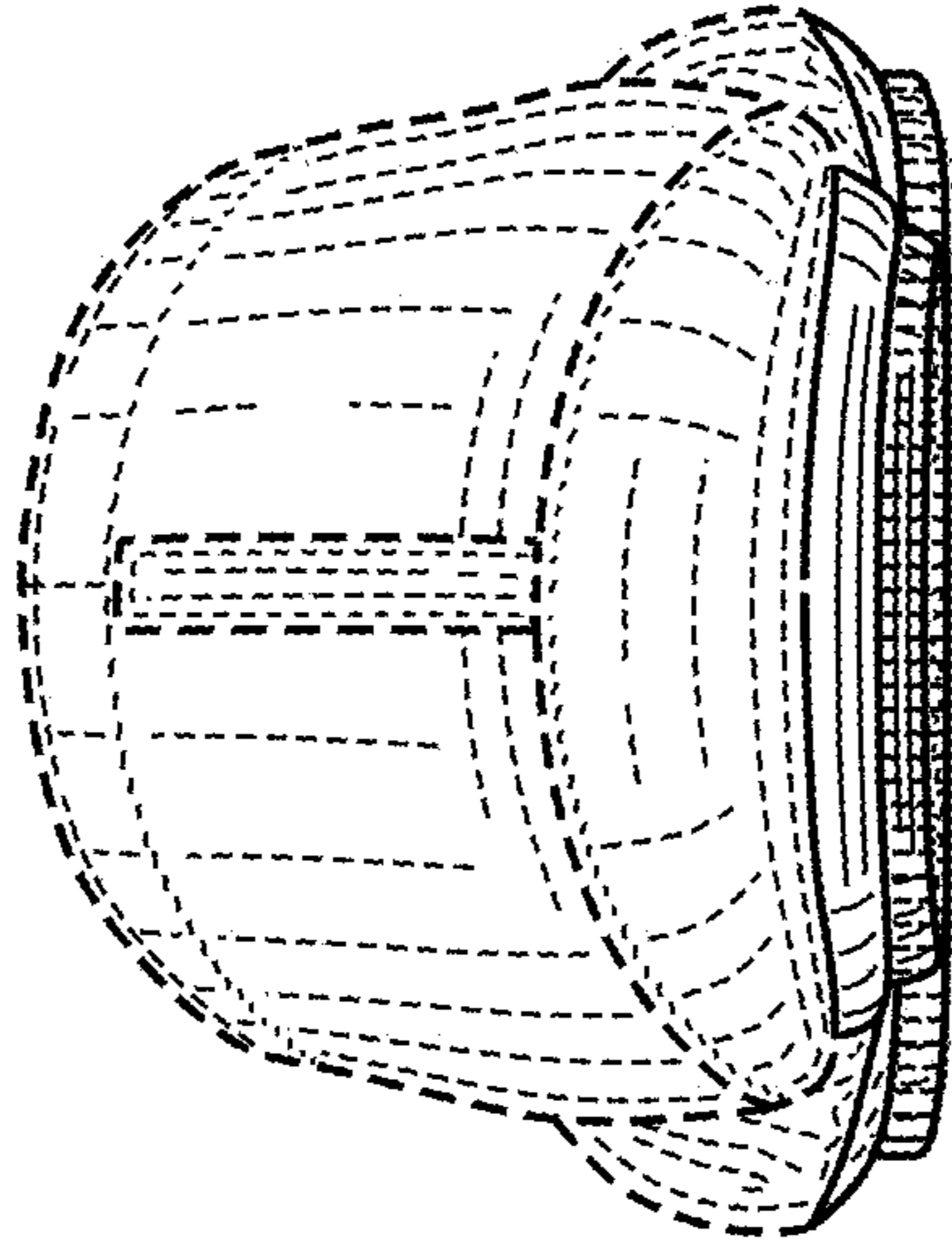

FIG. 14

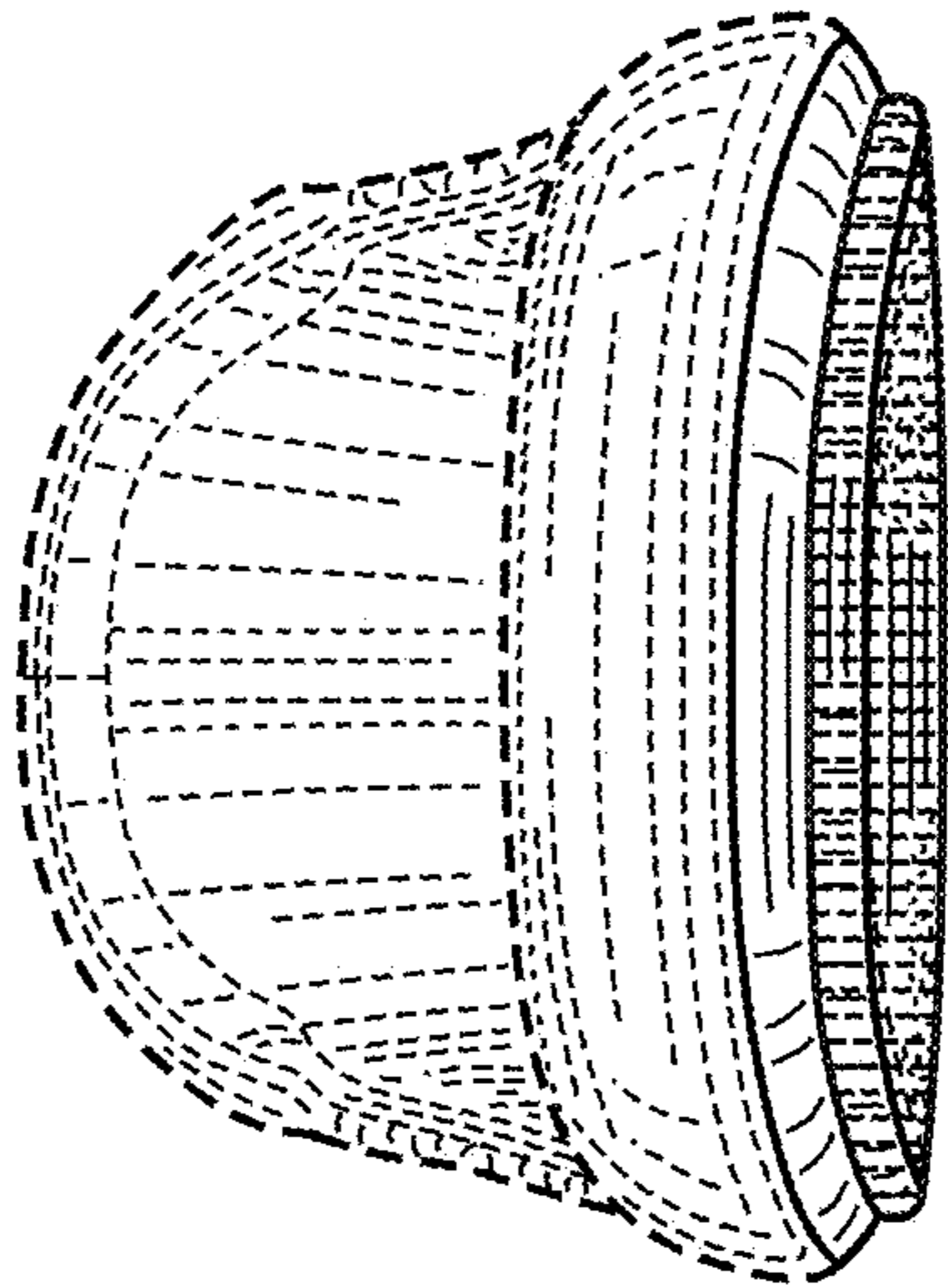

FIG. 13