



US00D761955S

(12) **United States Design Patent**
Marshall

(10) **Patent No.:** **US D761,955 S**
(45) **Date of Patent:** **** Jul. 19, 2016**

(54) **URINARY BAG COVER AND SUPPORT**

FOREIGN PATENT DOCUMENTS

(76) Inventor: **Mary L. Marshall**, Gainesville, FL (US)

JP 2004-081282 A 3/2004
WO WO 86/05969 10/1986

(**) Term: **14 Years**

OTHER PUBLICATIONS

(21) Appl. No.: **29/423,069**

Styledwel, Urinary bag covers, Feb. 22, 2013, <http://styledwel.com/>.*

(22) Filed: **May 29, 2012**

(Continued)

(51) **LOC (10) Cl.** **24-02**

(52) **U.S. Cl.**
USPC **D24/118**

(58) **Field of Classification Search**

USPC D24/118, 127, 108, 128, 111; 604/317,
604/327, 408, 403, 108, 339, 92, 415, 410,
604/332, 333; 128/DIG. 24; 383/22, 23, 35;
D9/707, 709, 696; 206/219; D18/56
CPC A61F 5/44; A61F 5/445; A61F 5/449;
A61F 5/4404; A61F 5/4408; A61F 5/451;
A61M 1/0019; A61M 25/0017; A61G 7/0503;
Y10S 128/24

See application file for complete search history.

Primary Examiner — David Muller
Assistant Examiner — Nathan Johnston

(74) *Attorney, Agent, or Firm* — Saliwanchik, Lloyd & Eisenschenk

(57) **CLAIM**

The ornamental design for a urinary bag cover and support, as shown and described.

DESCRIPTION

FIG. 1 is a front elevation view of the first embodiment of a urinary bag cover and support.

FIG. 2 is a rear elevation view thereof.

FIG. 3 is a front elevation view thereof, with the front panel open.

FIG. 4 is a right side elevation view thereof.

FIG. 5 is a left side elevation view thereof.

FIG. 6 is a top plan view thereof.

FIG. 7 is a bottom plan view thereof.

FIG. 8 is a front elevation view of the second embodiment of a urinary bag cover and support.

FIG. 9 is a rear elevation view thereof.

FIG. 10 is a front elevation view thereof, with the front panel open.

FIG. 11 is a right side elevation view thereof.

FIG. 12 is a left side elevation view thereof.

FIG. 13 is a top plan view thereof; and,

FIG. 14 is a bottom plan view thereof.

(56) **References Cited**

U.S. PATENT DOCUMENTS

2,662,525 A	12/1953	Priebe	
3,570,490 A	3/1971	Berger	
3,897,785 A	8/1975	Barto, Jr.	
4,122,851 A	10/1978	Grossner	
4,173,979 A	11/1979	Odis	
4,511,358 A	4/1985	Johnson, Jr. et al.	
4,533,355 A	8/1985	Fair	
4,606,736 A	8/1986	Van De Weghe	
D285,809 S *	9/1986	Sindler D19/27
4,705,512 A	11/1987	Faucher	
4,874,387 A	10/1989	Boone	
4,938,747 A	7/1990	Wallace	
4,955,879 A	9/1990	Mervine	
D316,602 S	4/1991	Dungan et al.	
5,032,118 A	7/1991	Mason	
5,087,251 A	2/1992	Heyman et al.	
5,193,553 A	3/1993	Kalinoski	

(Continued)

1 Claim, 10 Drawing Sheets

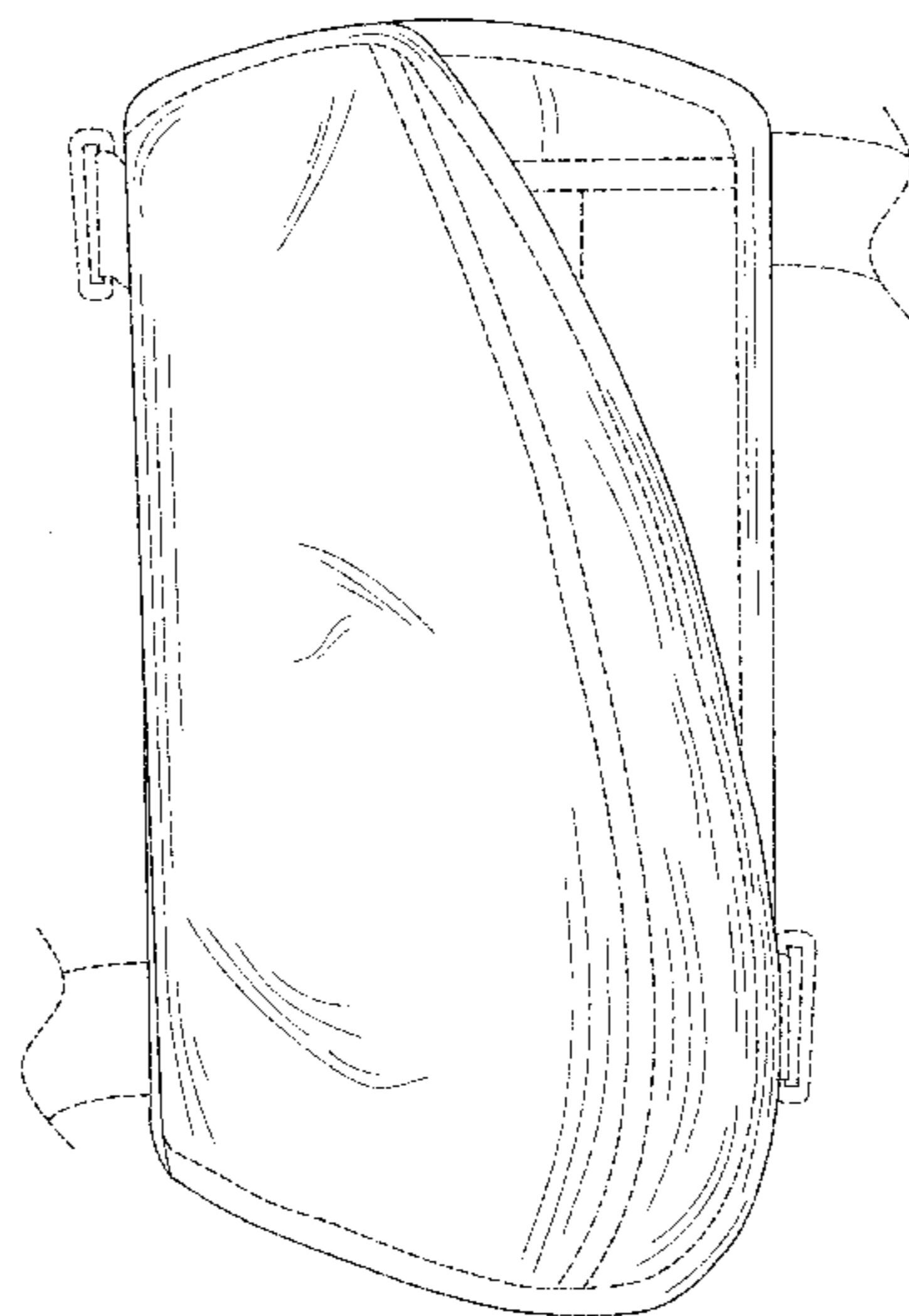

(56)

References Cited

U.S. PATENT DOCUMENTS

5,215,379 A 6/1993 Pickard et al.
 5,234,420 A 8/1993 Horton et al.
 5,267,987 A 12/1993 Fabricant
 D351,279 S * 10/1994 Montgomery D3/215
 5,392,973 A 2/1995 Benson
 5,407,111 A * 4/1995 Lanouette 224/579
 5,439,456 A 8/1995 Fabricant
 5,531,724 A 7/1996 Young et al.
 D376,905 S * 12/1996 Volmer D3/221
 D378,633 S * 4/1997 Granito D3/228
 5,643,236 A 7/1997 Hadley
 5,653,701 A 8/1997 Millman
 5,700,257 A 12/1997 Minick et al.
 5,716,388 A * 2/1998 Petelle 607/108
 5,759,180 A 6/1998 Myhres
 D397,549 S * 9/1998 Edwards D3/215
 5,865,819 A 2/1999 Cisco, Jr. et al.
 5,961,501 A 10/1999 Cassidy et al.
 D438,616 S 3/2001 Williams
 D472,512 S * 4/2003 Palmer D12/417
 D485,465 S * 1/2004 Hassett D6/626
 6,887,223 B2 5/2005 Bisbee
 D532,199 S * 11/2006 Balchunas et al. D3/303
 D615,646 S * 5/2010 Russell D24/118
 D684,260 S * 6/2013 Lund et al. D24/118
 2002/0077609 A1 6/2002 Johnson

2003/0121194 A1 7/2003 Rappaport et al.
 2004/0204695 A1 10/2004 Bisbee
 2004/0215158 A1 10/2004 Anderson
 2004/0261159 A1 12/2004 Reilly et al.
 2005/0261645 A1 11/2005 Conrad et al.
 2006/0224130 A1 10/2006 Garrett
 2006/0253091 A1 11/2006 Vernon
 2006/0258997 A1 11/2006 Belt
 2006/0293631 A1 12/2006 Bolt
 2007/0208314 A1 9/2007 Barrientos
 2007/0260208 A1 11/2007 May
 2008/0004560 A1 1/2008 Miskie
 2008/0047990 A1 2/2008 Morgan et al.
 2008/0140034 A1 6/2008 Edling
 2008/0269700 A1 10/2008 O'Toole et al.
 2009/0112171 A1 4/2009 Ng et al.
 2009/0247970 A1 10/2009 Keleny et al.
 2014/0207093 A1 * 7/2014 Marshall 604/327

OTHER PUBLICATIONS

Cypress Medical Products, Bedside Waste Bags (Item#92-03),
 obtained Sep. 10, 2007 from <http://www.cypressmed.com>.
 LL Medico, Urinary Leg Bag Holders by Netti®, obtained Sep. 10,
 2007 from <http://www.LLmedico.com>.
 Shield Healthcare, Leg Bag Holder (Item#BA-150121), obtained
 Sep. 10, 2007 from <http://www.shieldhealthcare.com>.

* cited by examiner

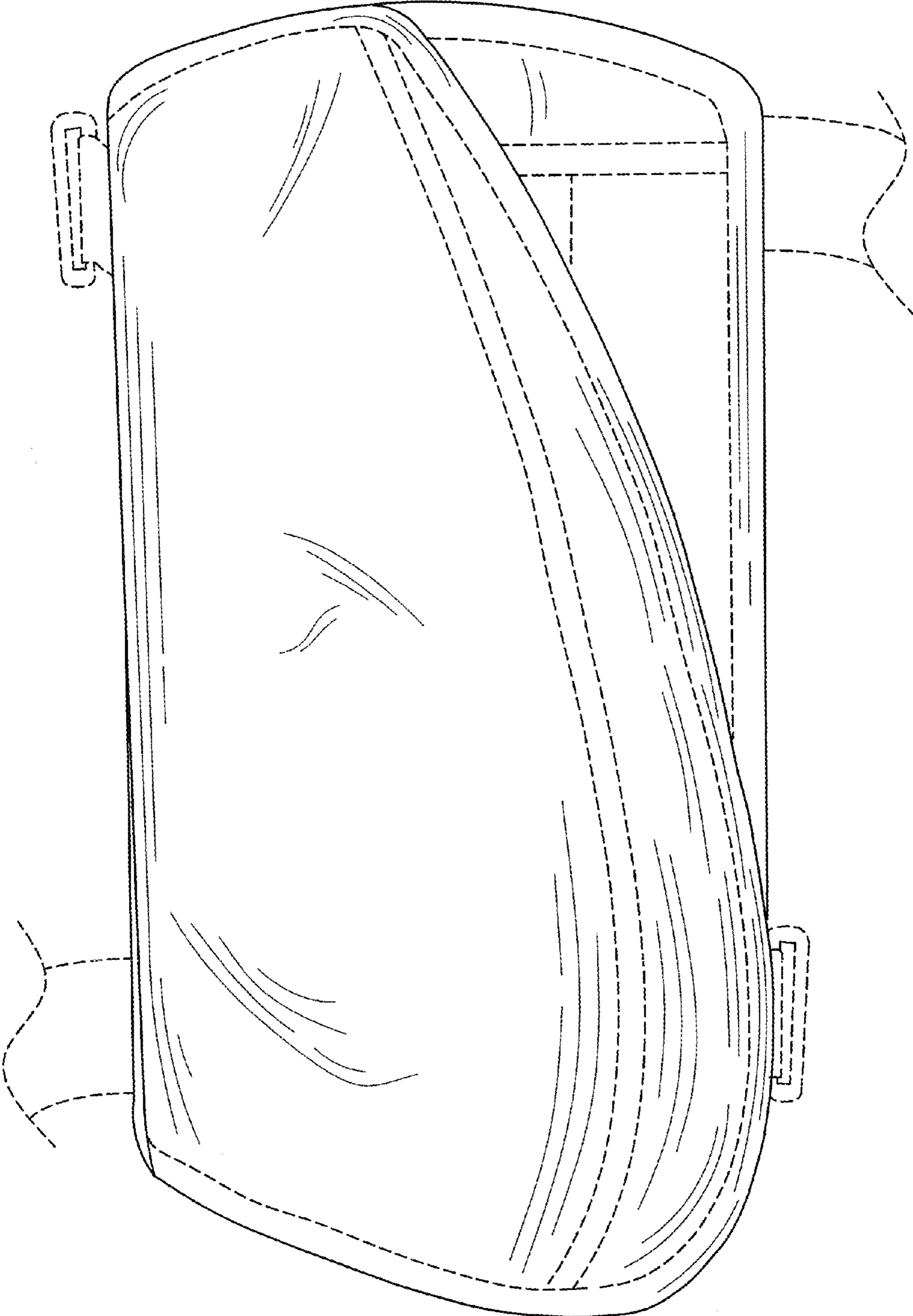

FIG. 1

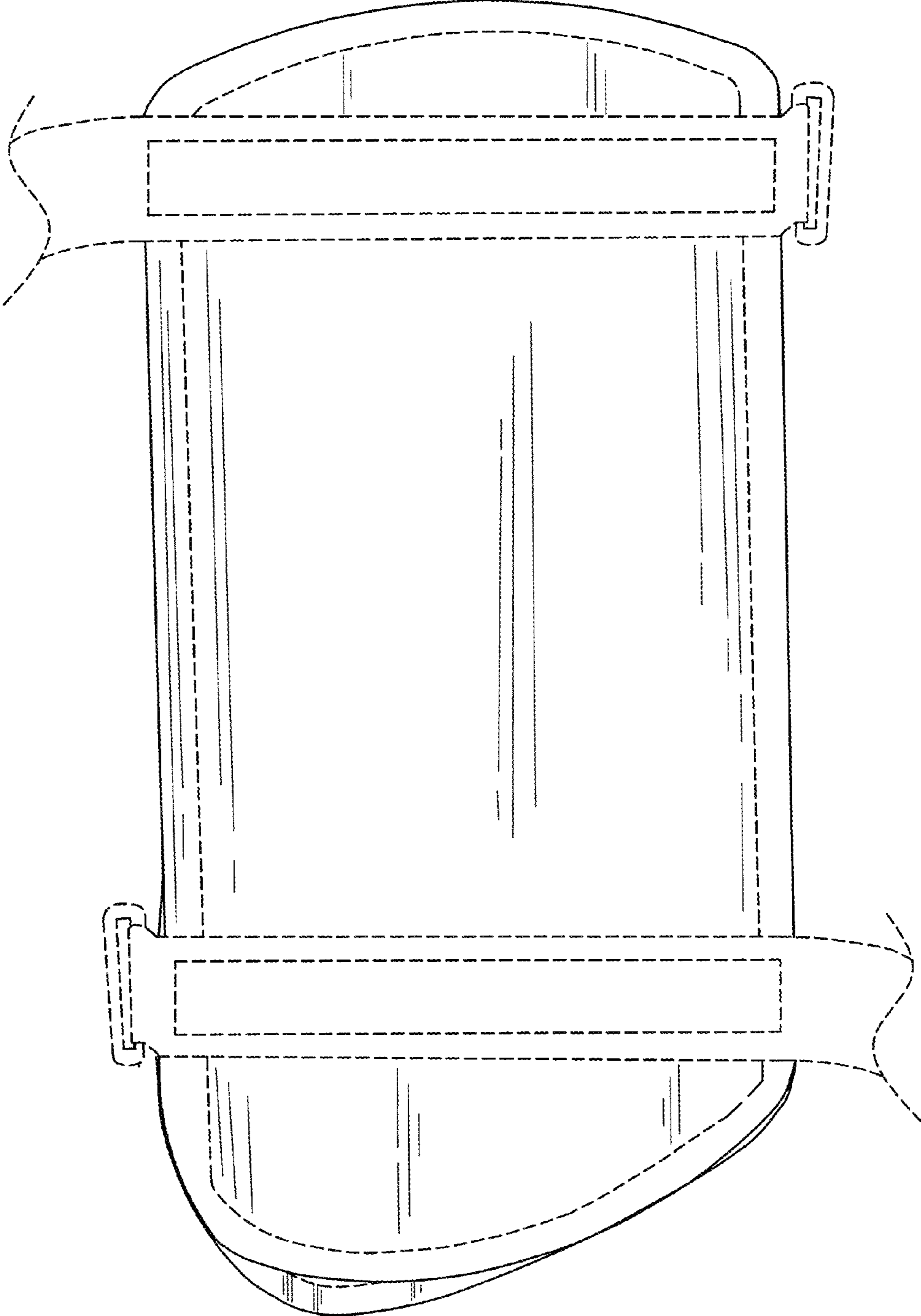

FIG. 2

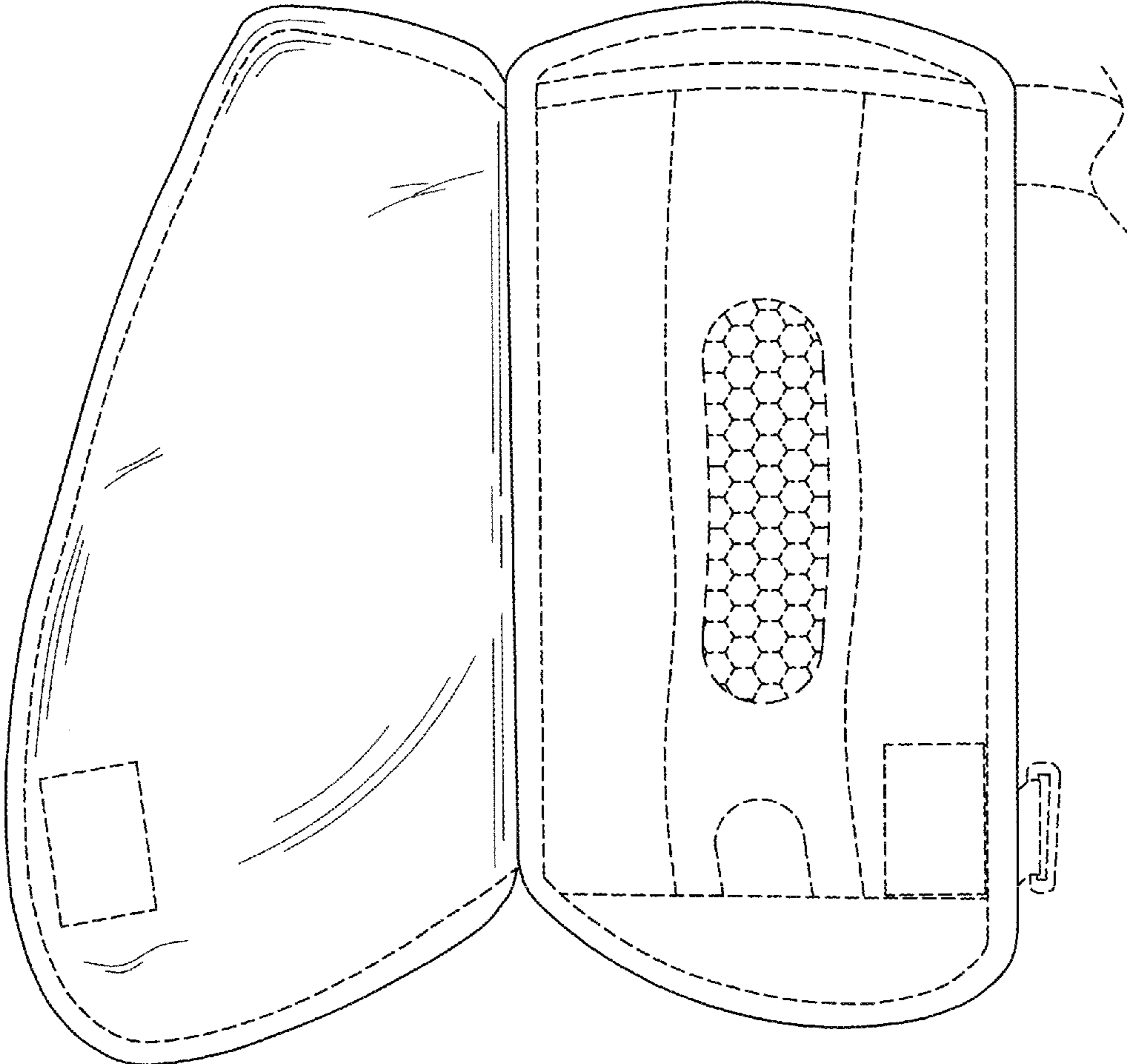

FIG. 3

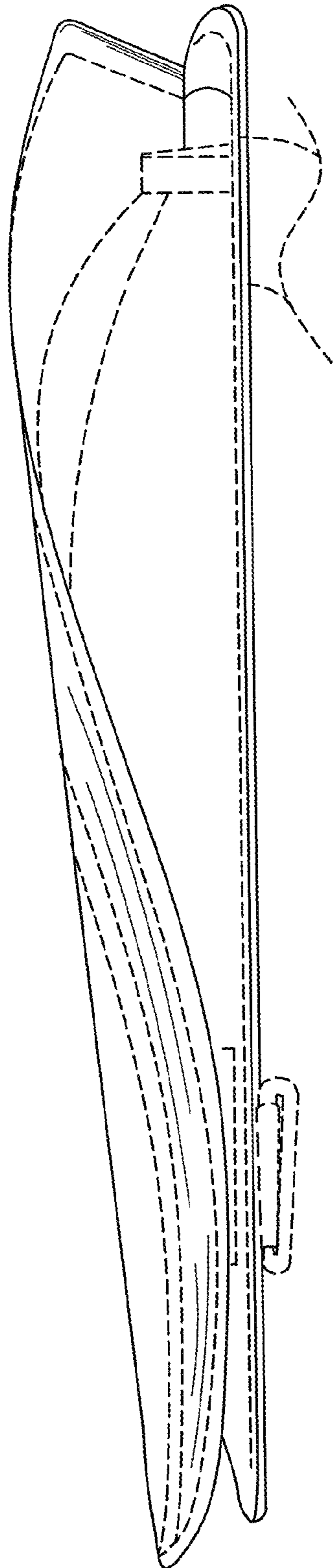

FIG. 4

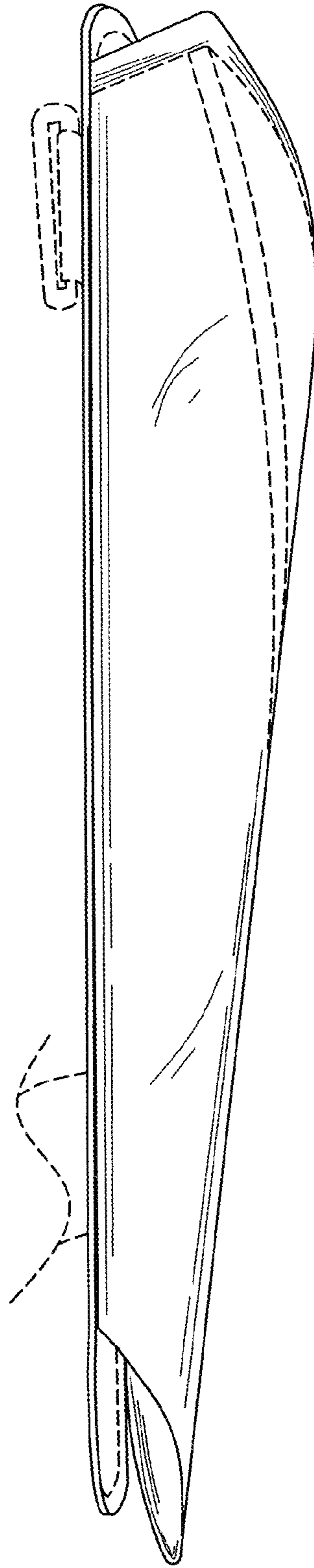

FIG. 5

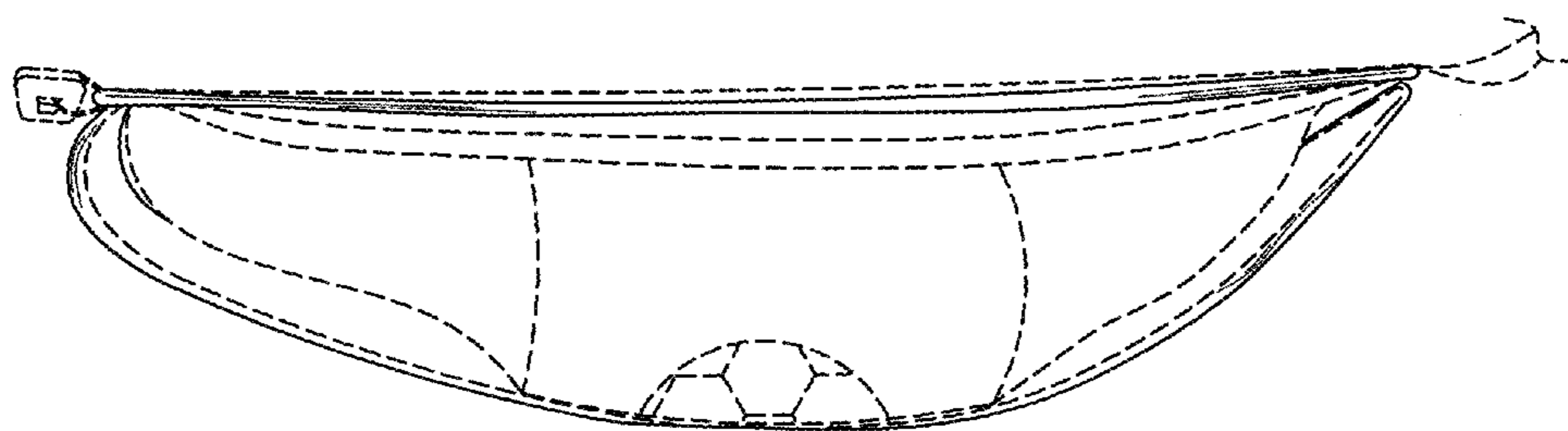

FIG. 6

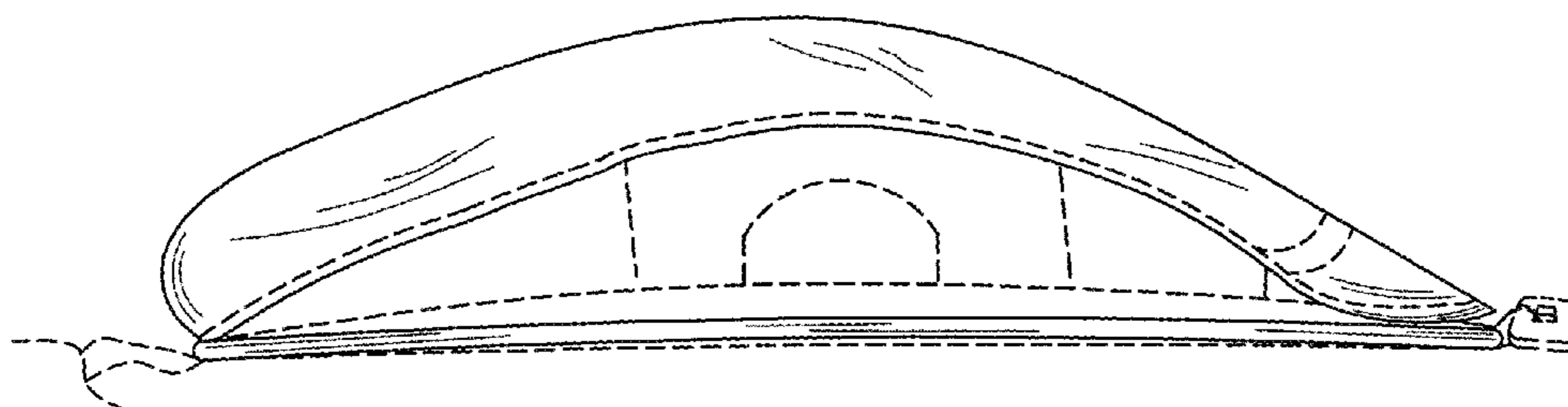

FIG. 7

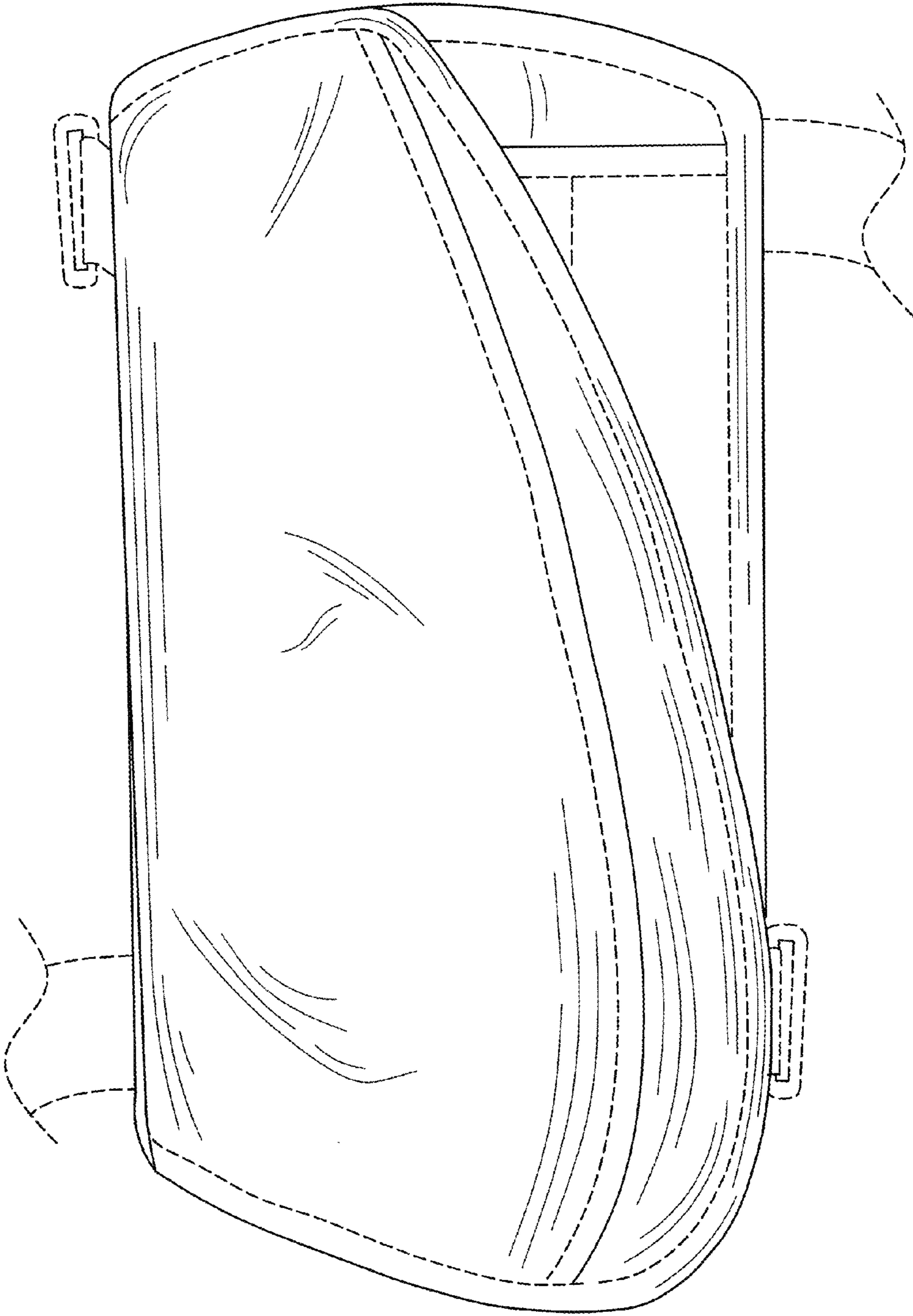

FIG. 8

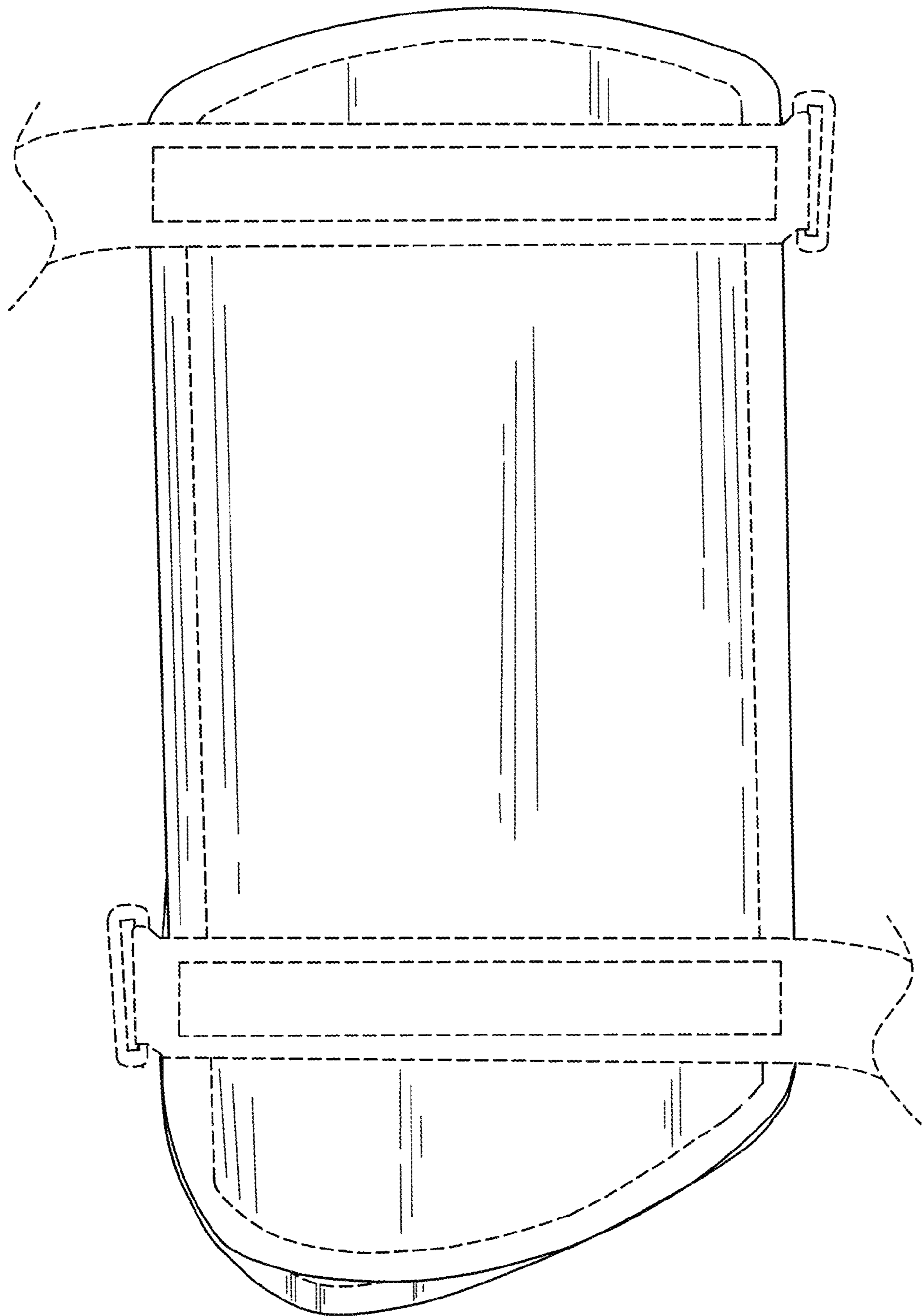

FIG. 9

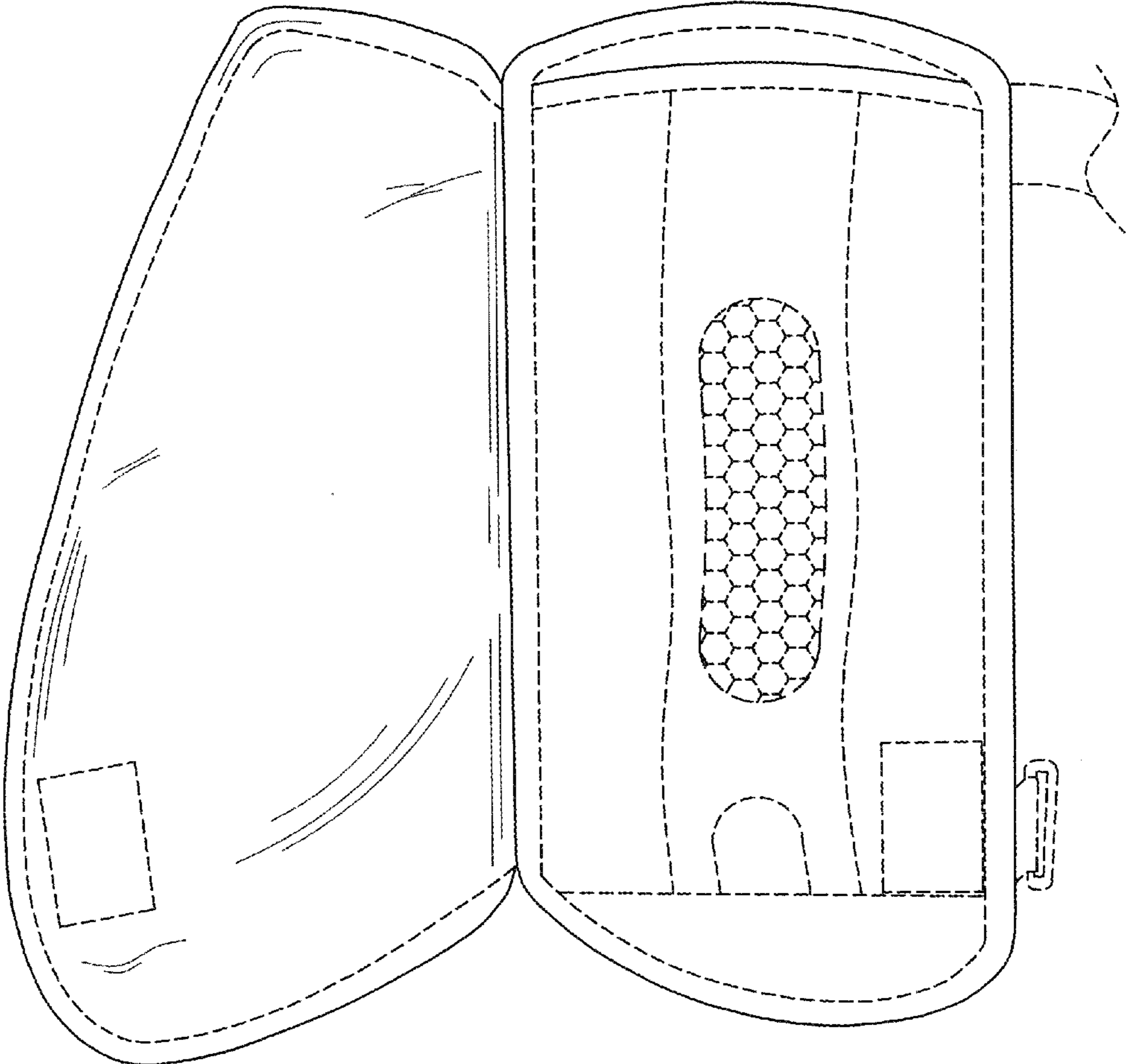

FIG. 10

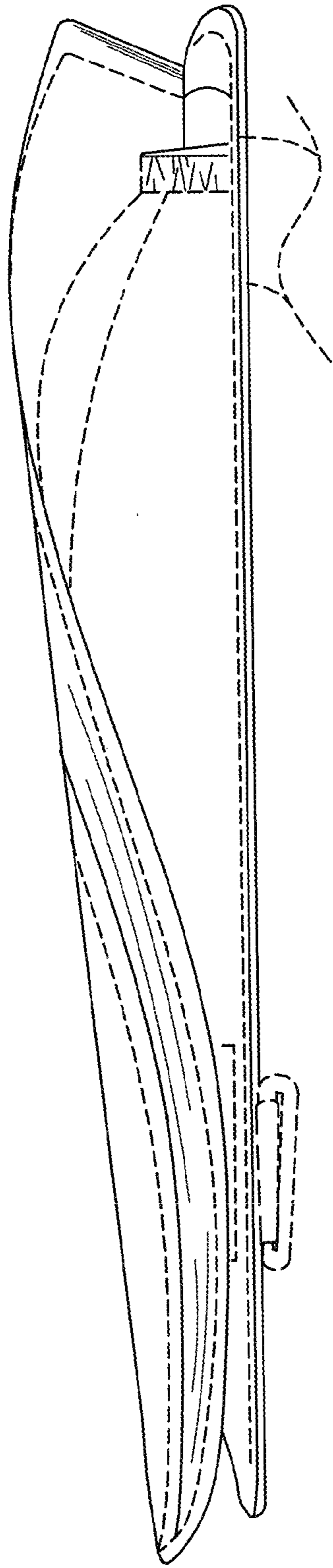

FIG. 11

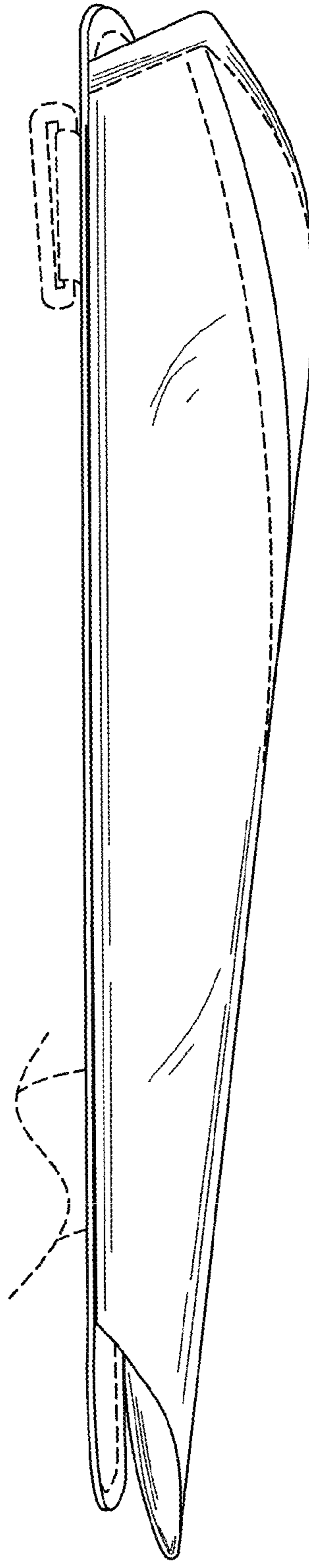

FIG. 12

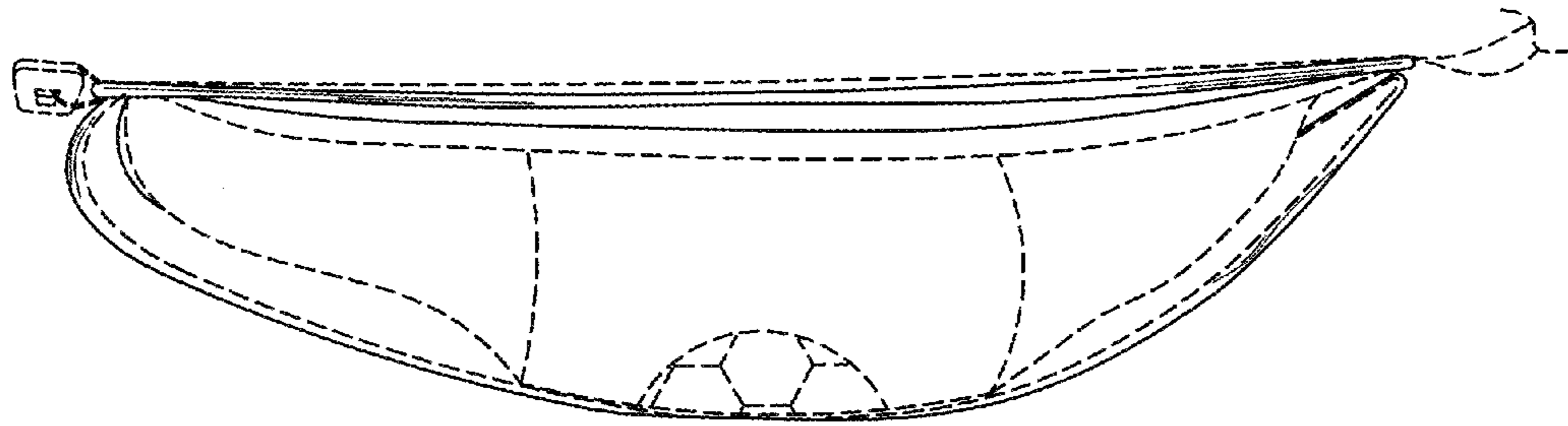

FIG. 13

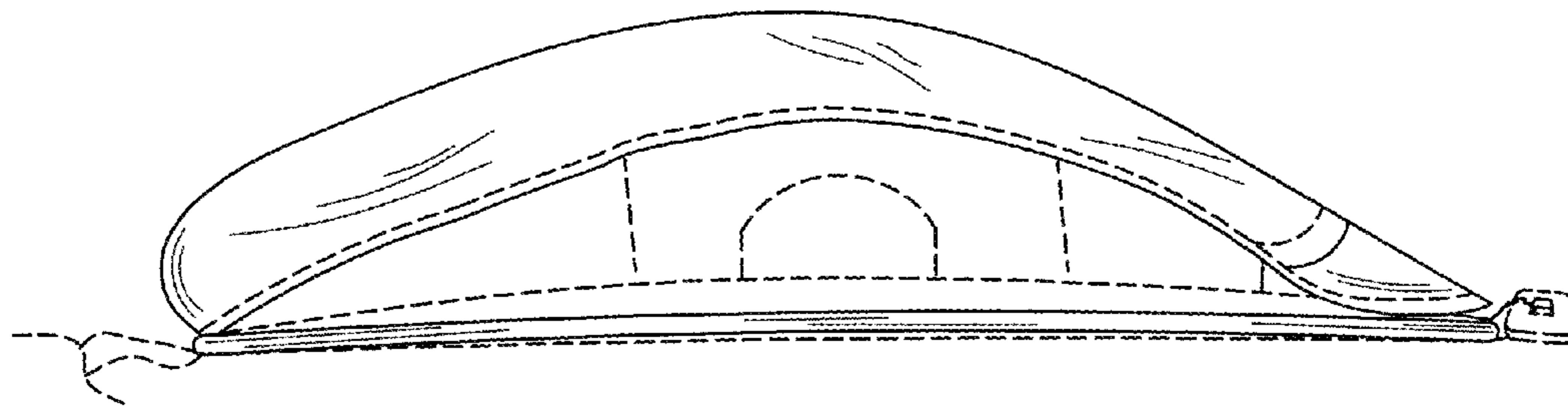

FIG. 14