



US00D761928S

(12) **United States Design Patent**  
**Adair et al.**

(10) **Patent No.:** **US D761,928 S**  
(45) **Date of Patent:** **\*\* Jul. 19, 2016**

(54) **FIREARM GRIP**

(71) Applicant: **Knight's Armament Company**,  
Titusville, FL (US)

(72) Inventors: **Nathan Michael Adair**, Orlando, FL  
(US); **Charles Reed Knight, III**, Merritt  
Island, FL (US)

(73) Assignee: **Knight's Armament Company**,  
Titusville, FL (US)

(\*\*) Term: **14 Years**

(21) Appl. No.: **29/478,877**

(22) Filed: **Jan. 9, 2014**

(51) **LOC (10) Cl.** ..... **22-01**

(52) **U.S. Cl.**  
USPC ..... **D22/108**

(58) **Field of Classification Search**  
USPC ..... D22/108; 362/109-114; 42/90, 94, 114,  
42/117, 124-127, 131, 146  
CPC ..... F41C 23/10; F41C 23/14; F41C 23/16;  
F41C 23/18  
See application file for complete search history.

(56) **References Cited**

**U.S. PATENT DOCUMENTS**

D667,917 S \* 9/2012 Fitzpatrick et al. .... D22/108  
2003/0106252 A1\* 6/2003 Hines ..... 42/90

2004/0064994 A1\* 4/2004 Luke ..... 42/85  
2010/0236124 A1\* 9/2010 Troy ..... 42/90  
2012/0085013 A1\* 4/2012 Cahill ..... 42/96  
2012/0266514 A1\* 10/2012 Michal et al. .... 42/90  
2014/0041273 A1\* 2/2014 Masters ..... 42/71.01  
2014/0325889 A1\* 11/2014 Michal et al. .... 42/75.01

\* cited by examiner

*Primary Examiner* — Michael A Pratt

(74) *Attorney, Agent, or Firm* — GrayRobinson P.A.;  
Michael J. Colitz, III

(57) **CLAIM**

The ornamental design for a firearm grip, as shown and described.

**DESCRIPTION**

FIG. 1 is a perspective bottom view of a firearm grip comprising our design;  
FIG. 2 is a perspective top view of a firearm grip comprising our design;  
FIG. 3 is a bottom view of a firearm grip comprising our design;  
FIG. 4 is a top view of a firearm grip comprising our design;  
FIG. 5 is a side view of a firearm grip comprising our design;  
FIG. 6 is a side view of one of the grips of a firearm grip comprising our design; and,  
FIG. 7 is a bottom perspective view of a firearm grip comprising our design.

**1 Claim, 4 Drawing Sheets**

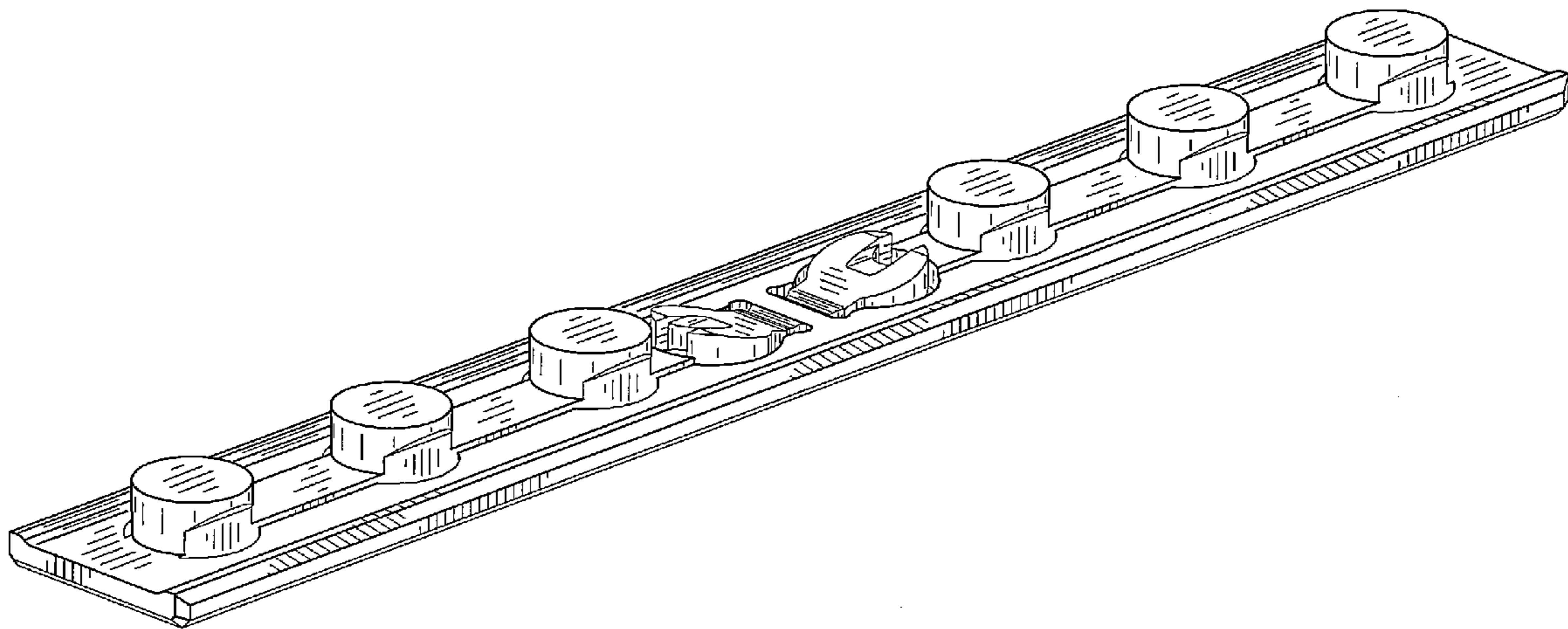

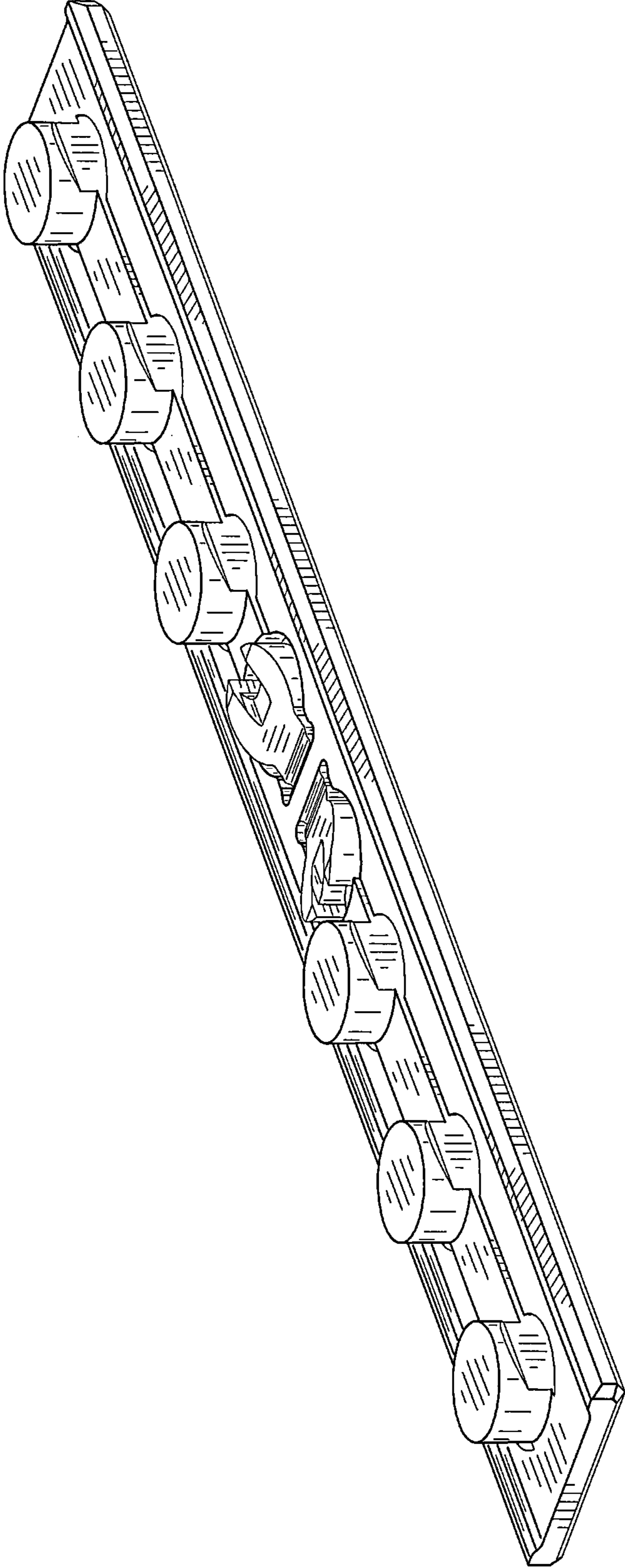

FIG. 1

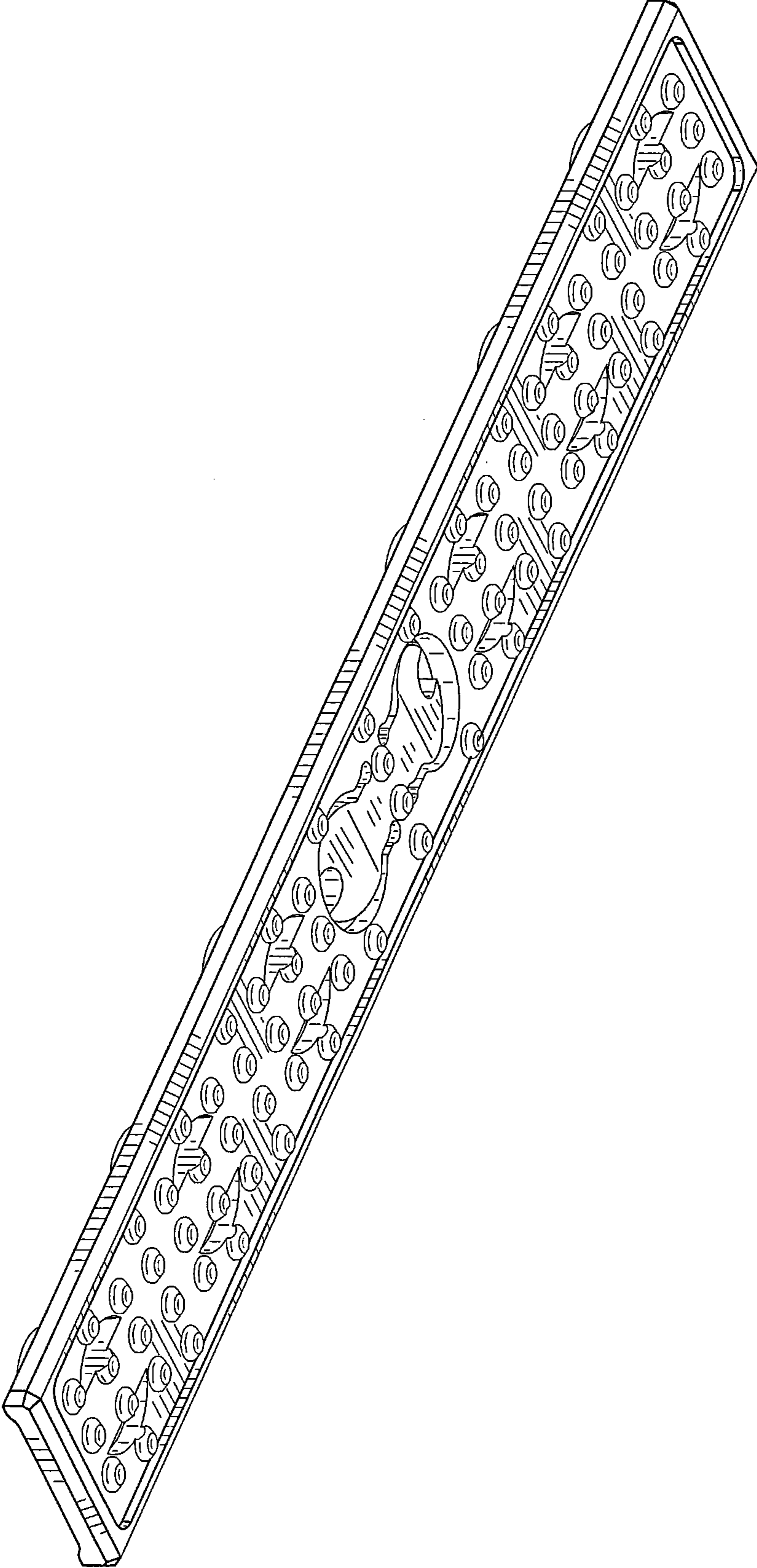

FIG. 2

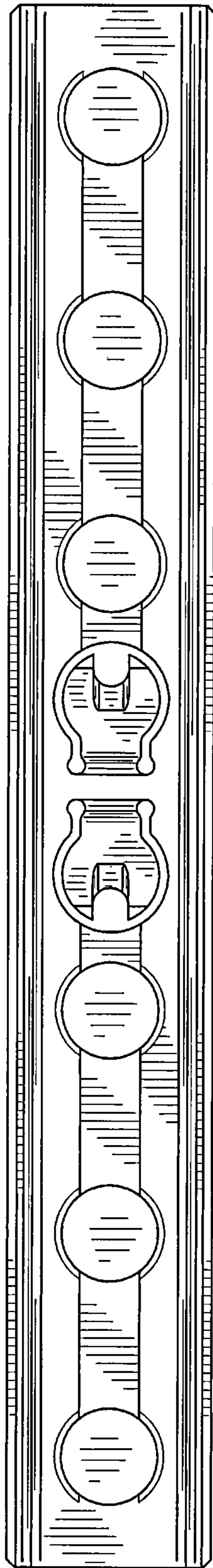

FIG. 3

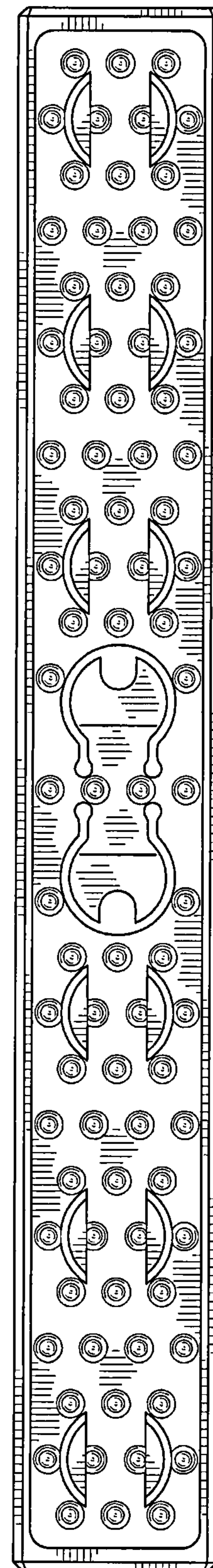

FIG. 4



FIG. 5

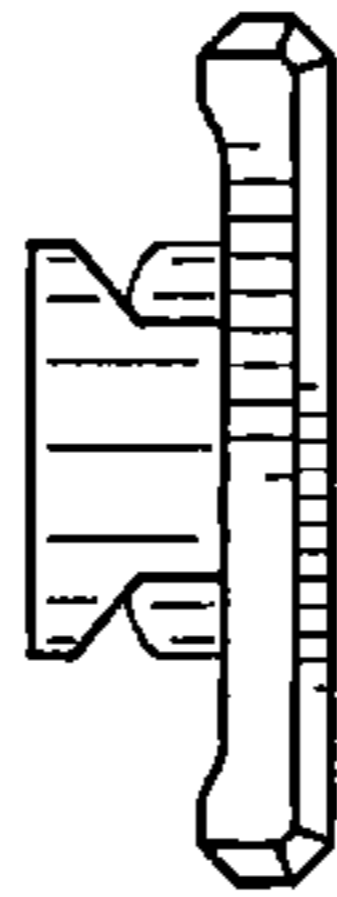

FIG. 6

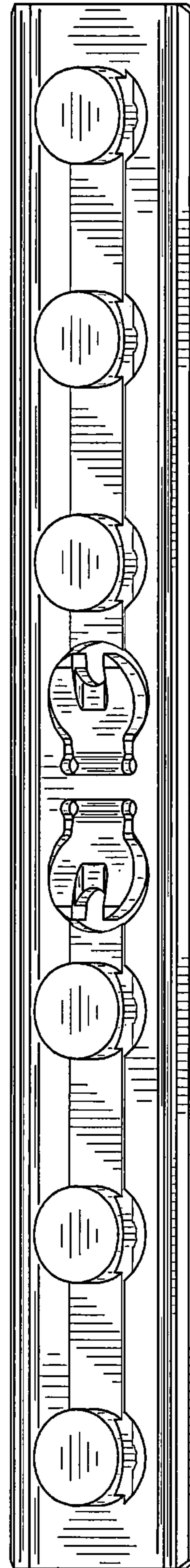

FIG. 7