



US00D761917S

(12) **United States Design Patent**  
**Kjellman et al.**

(10) **Patent No.:** **US D761,917 S**  
(45) **Date of Patent:** **\*\* Jul. 19, 2016**

(54) **GAME PIECE**

(71) Applicants: **Shaun Kjellman**, Kirkland, WA (US);  
**Jason Berube**, Hampstead, NH (US)

(72) Inventors: **Shaun Kjellman**, Kirkland, WA (US);  
**Jason Berube**, Hampstead, NH (US)

(\*\*) Term: **14 Years**

(21) Appl. No.: **29/474,934**

(22) Filed: **Mar. 19, 2015**

(51) **LOC (10) Cl.** ..... **21-01**

(52) **U.S. Cl.**  
USPC ..... **D21/386**

(58) **Field of Classification Search**  
USPC ..... D21/385, 386; D14/155, 159  
CPC ..... A63F 3/00697  
See application file for complete search history.

(56) **References Cited**

U.S. PATENT DOCUMENTS

D424,560 S \* 5/2000 Heath ..... D10/104.1  
D424,561 S \* 5/2000 Heath ..... D10/104.1

D522,071 S \* 5/2006 Strother ..... D21/578  
D566,796 S \* 4/2008 Feeney ..... D21/576  
D596,244 S \* 7/2009 Levy ..... D21/622  
D719,621 S \* 12/2014 Song ..... D21/578  
D727,867 S \* 4/2015 Chao ..... D14/130

\* cited by examiner

*Primary Examiner* — George D Kirschbaum

(57) **CLAIM**

We claim the ornamental design for a game piece, as shown and described.

**DESCRIPTION**

FIG. 1 is a perspective view of a game piece, showing my new design;  
FIG. 2 is a right-side elevational view thereof;  
FIG. 3 is a left-side elevational view thereof;  
FIG. 4 is a front elevational view thereof;  
FIG. 5 is a rear elevational view thereof;  
FIG. 6 is a top plan view thereof;  
FIG. 7 is a bottom plan view thereof;  
FIG. 8 is a bottom-front perspective view thereof; and,  
FIG. 9 is a bottom-rear perspective view thereof.

**1 Claim, 4 Drawing Sheets**

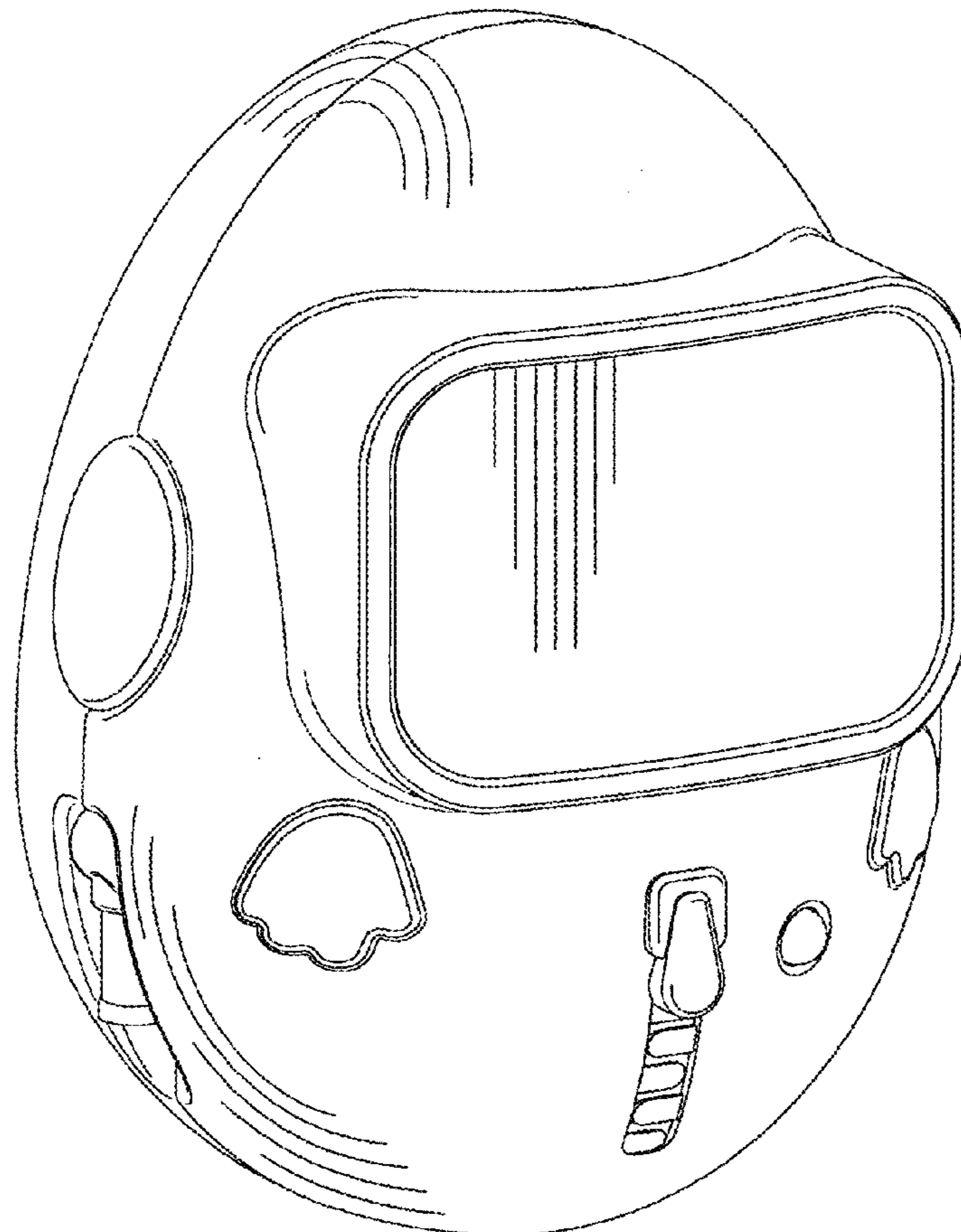

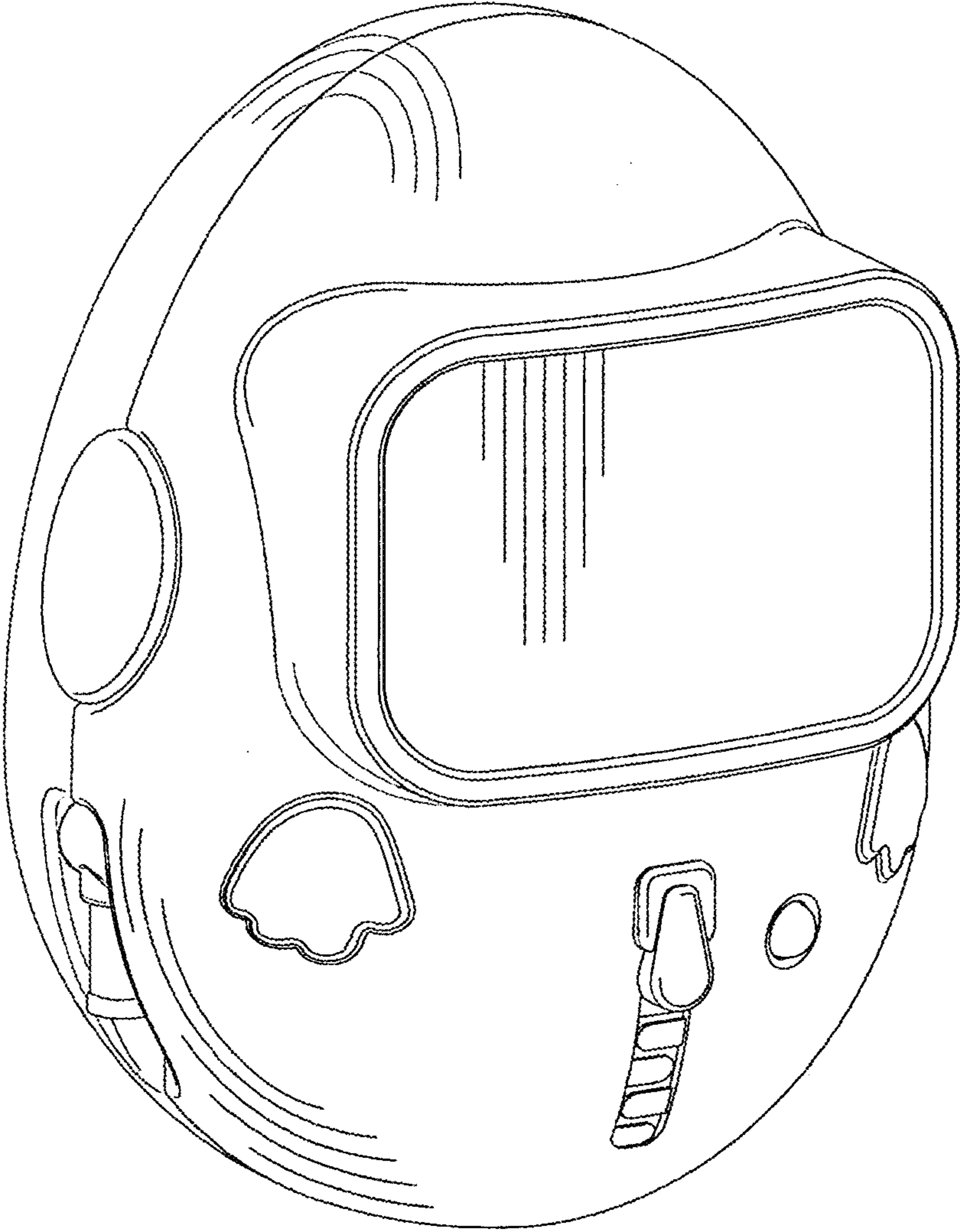

FIG. 1

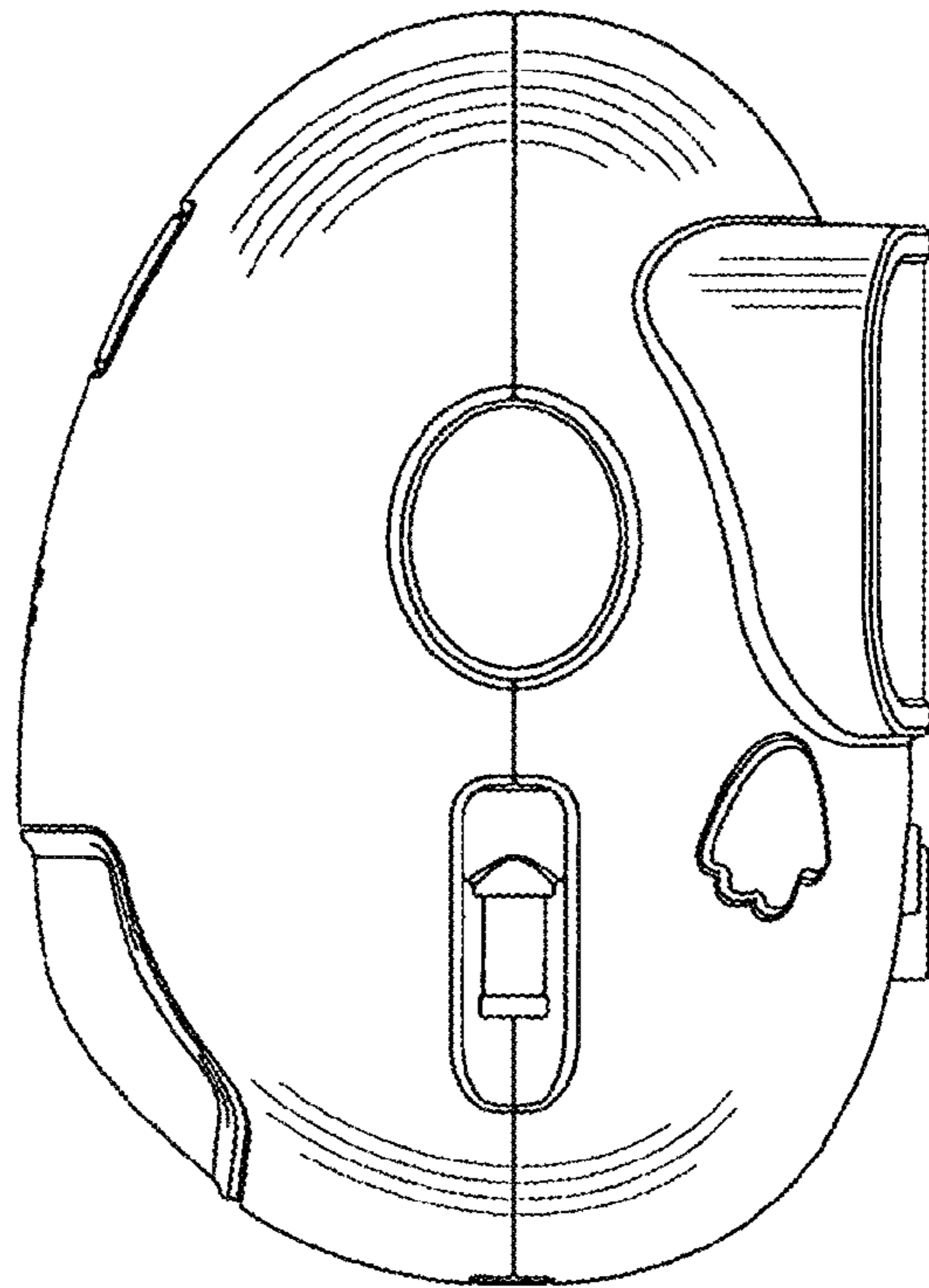

FIG. 2

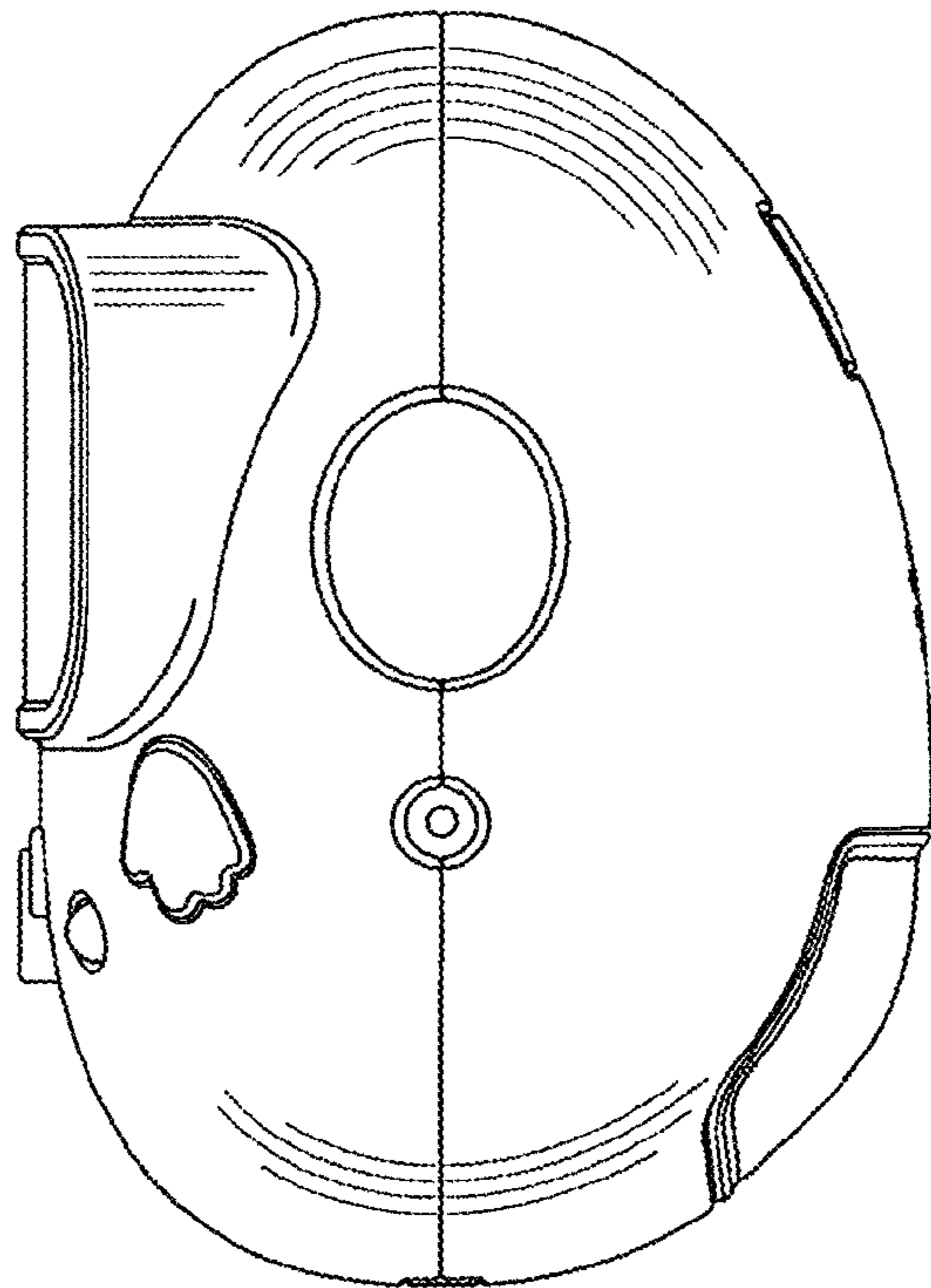

FIG. 3

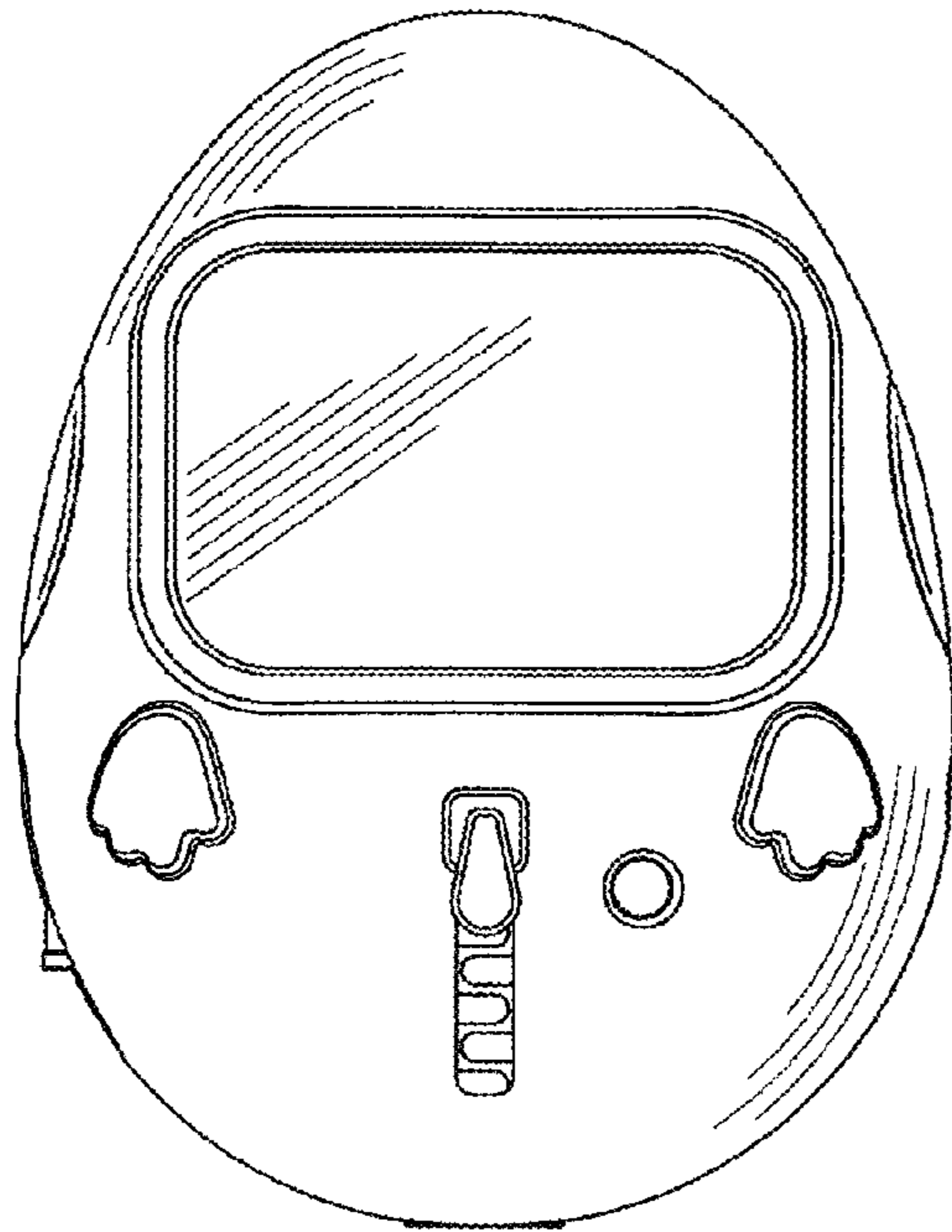

FIG. 4

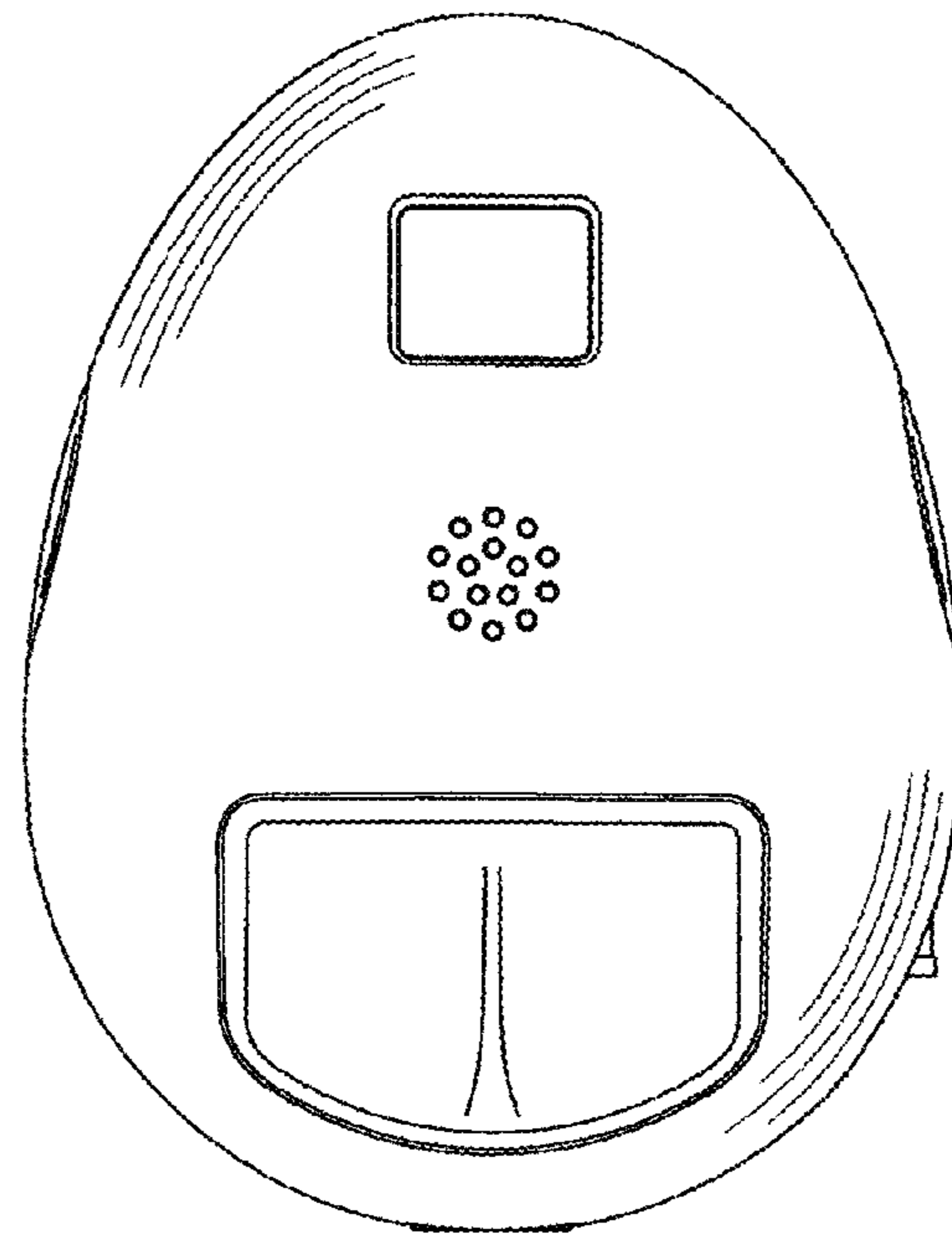

FIG. 5

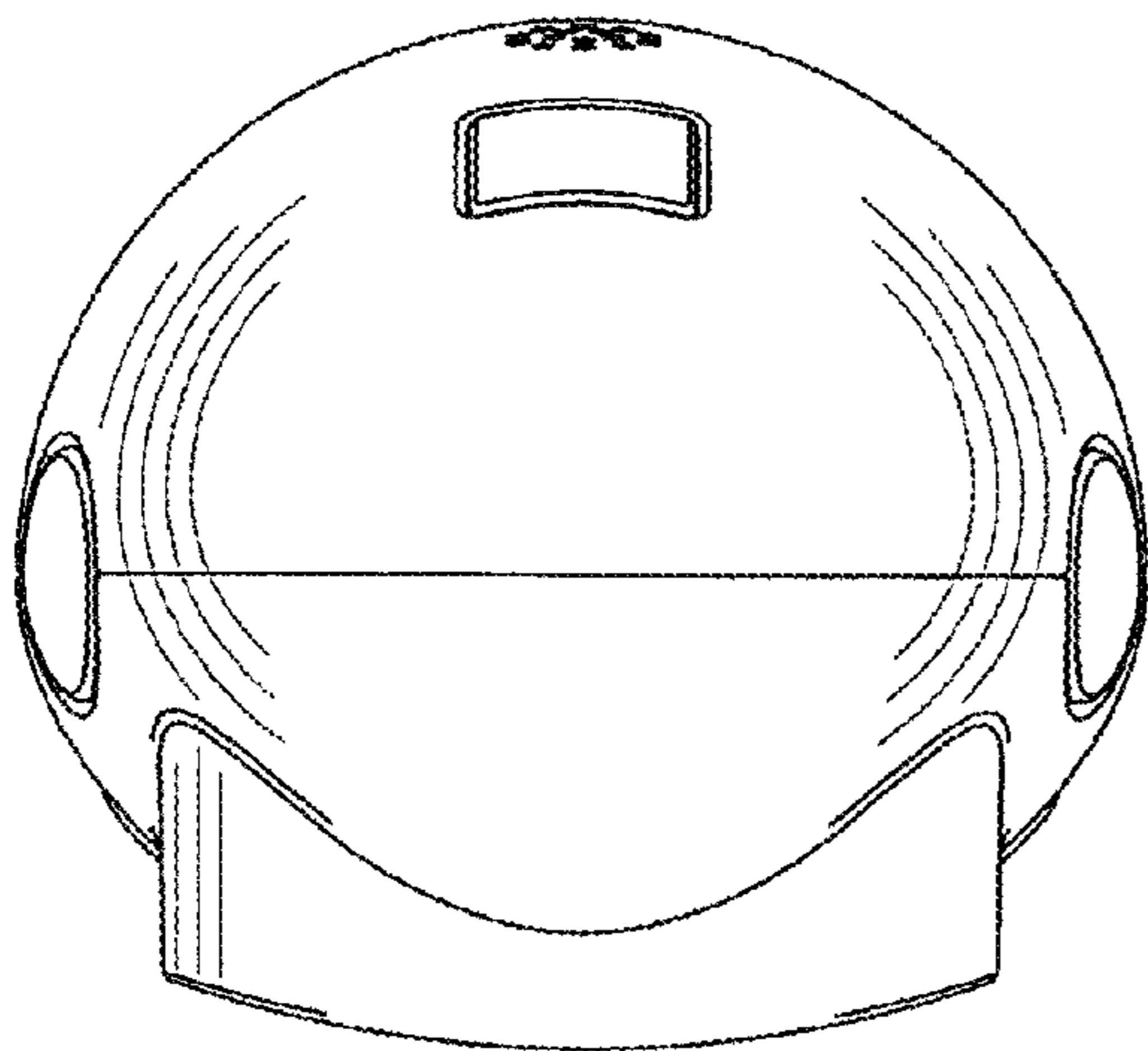

FIG. 6

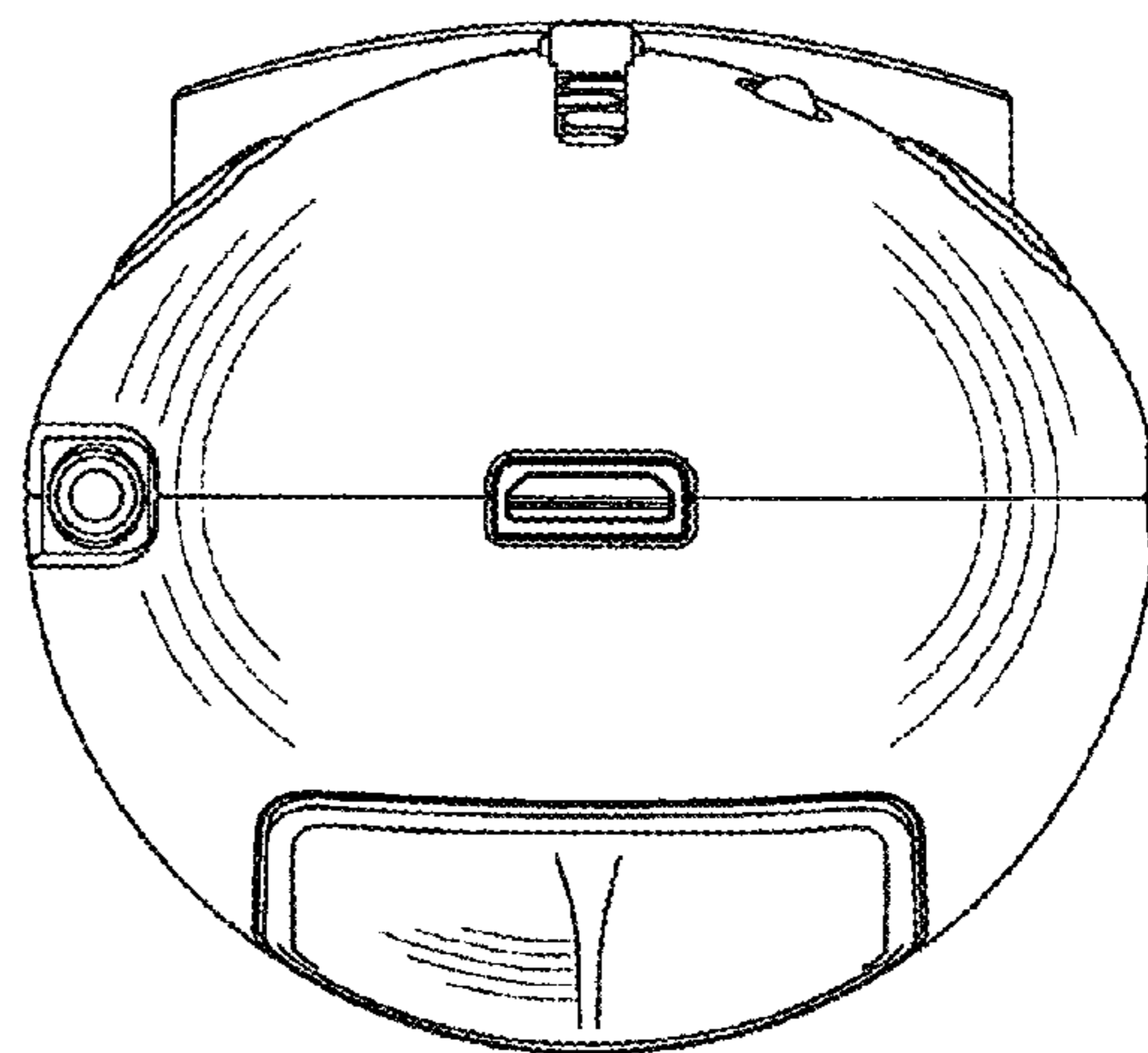

FIG. 7

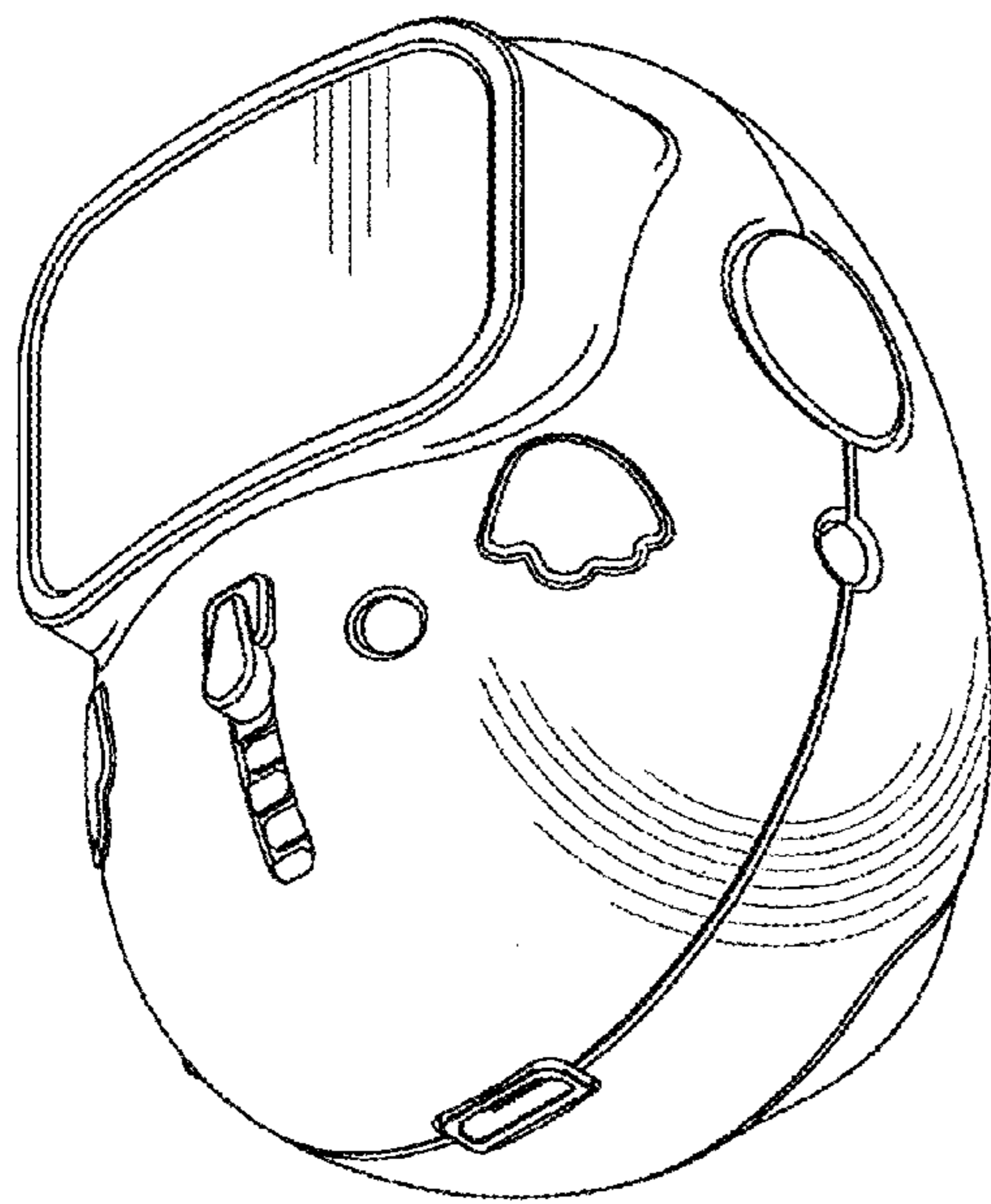

FIG. 8

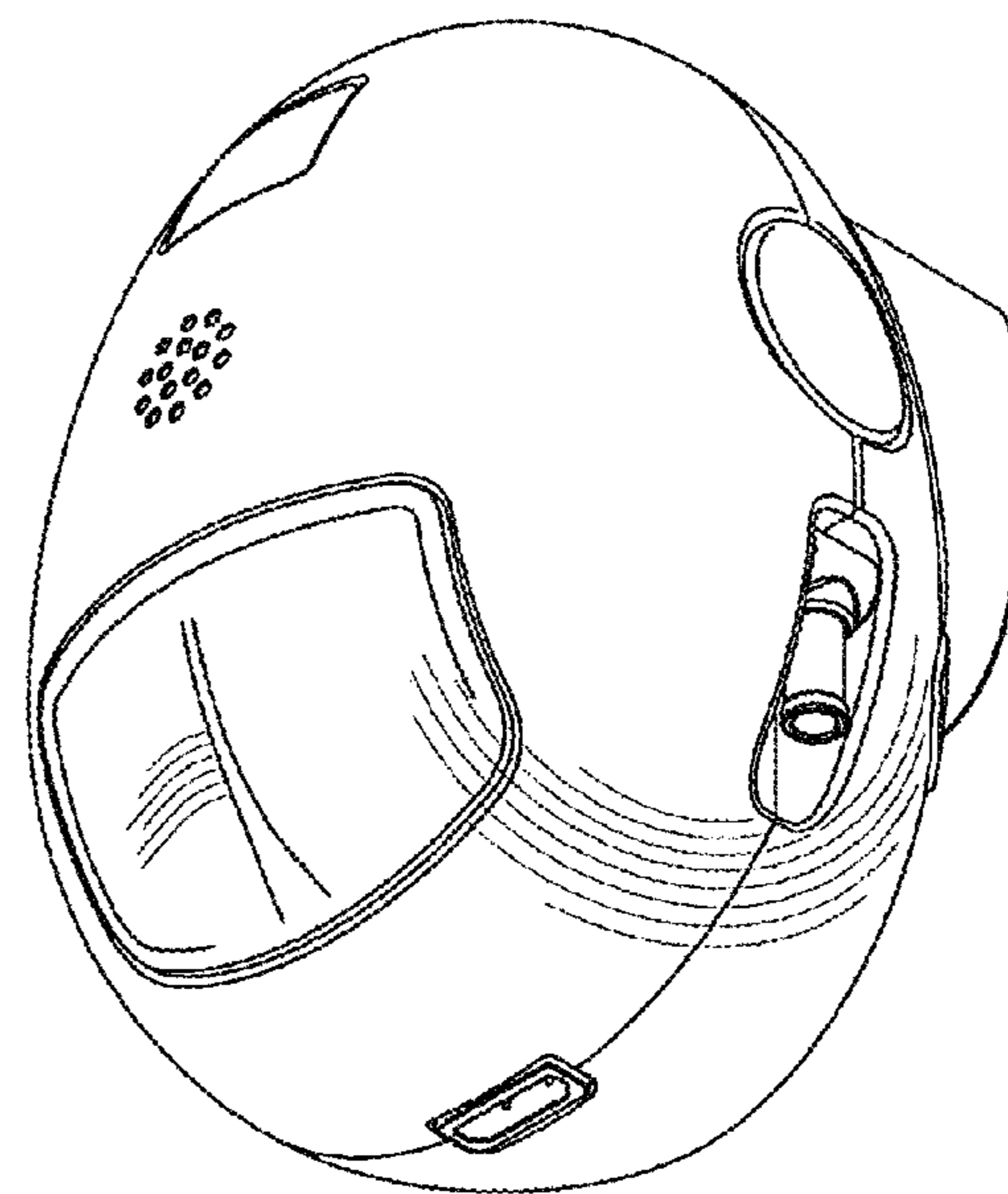

FIG. 9